

innovate / customize / educate

design

IT'S SAFE



Gasket **CRITERIA.**



dream

IT'S SAFE



ever wonder?

we do.

over 85% of our sales are
our engineers working with yours
to design a better way.
the first spiral wound. thermiculite.[®]
not afraid of "never-been-done-before."
you won't be either.
wonder around.

it's flexitallic safe.





Gasket Design Criteria Table of Contents

	<i>Page</i>
Manufacturing Units	2
Introduction	3
Section I - Gasket Selection	4
Change Gasket	6
Sheet Materials	8
Thermiculite®	9
PTFE Products - Sigma®	12
PTFE Products - Fluoroseal	14
Flexitallic Flexicarb®	15
Compressed Fiber Gasket	16
Core4 Sheet Products	17
Sheet Materials Chemical Compatibility Chart	18
Insulating Sets	21
Metal Jacketed Gaskets	23
Spiral Wound Gasket	26
Sizing of Spiral Wound Gaskets	34
Flexpro™ Gasket	36
Metal Reinforced Gasket (MRG)	37
CPR Gasket	37
Ring Type Joint (RTJ)	38
Specialized Ring Type Joint	40
Lens Ring	41
Weld Gasket	42
Section II - Joint Integrity Calculations	43
ASME Boiler & Pressure Vessel Code Calculations	44
PVRC Method	48
Section III - Gasket Installation	50
Bolt Torque Sequence	51
Recommended Torque	54
Torque Required to Produce Bolt Stress	58
Installation	59
Flexitallic's Flange Assembly and Proper Bolting Procedures Seminar	59
Troubleshooting	60
Section IV - Useful Technical Data	61
Metallic Gasket Materials	61
Useful Material Data	63
Bolting Data	64
Flange Facing Dimensions	67
Ordering Flexitallic Gaskets for Special Flange Designs	68
Metric Unit Conversions	70
Terms	72

Manufacturing Units

◆ Owned Manufacturing Plants

Flexitallic Ltd.
Cleckheaton, UK
Tel: +44 1274 851 273

Flexitallic L.P.
Deer Park, TX, USA
Tel: +1 281 604 2400

Custom Rubber Products
2625 Bennington
Houston, TX, USA
Tel: +1 713 691 2211

Flexitallic Sealing Technology (Suzhou) Co., Ltd.
Wujiang, Jiangsu, P.R. China
Tel: +86 512 6303 2839

AGS Flexitallic, Inc.
Edmonton, Alberta, Canada
Tel: +1 780 466 5050

SIEM Supranite
Paris, France
Tel: +33 1 48 88 88 88

Flexitallic Middle East LLC
Kingdom of Saudi Arabia
Tel: 0096-3-8089635

Flexitallic LLC
Ras Al Khaimah, UAE
Tel: +971 (0)7 243 4305

◆ Joint Ventures

Equiter S.A. de C.V.
Guadalajara, Mexico
Tel: +52 3 612 8483

Novus Sealing Caspian LLP
Atyrau, Republic of Kazakhstan T:
Tel: +7 (7122) 251103

▲ Branch Offices & Warehouses

The Sealex Group
Aberdeen, Scotland, UK
Tel: +44 1224 725241

The Sealex Group
Middlesbrough, England
Tel: +44 (0)1642 245906

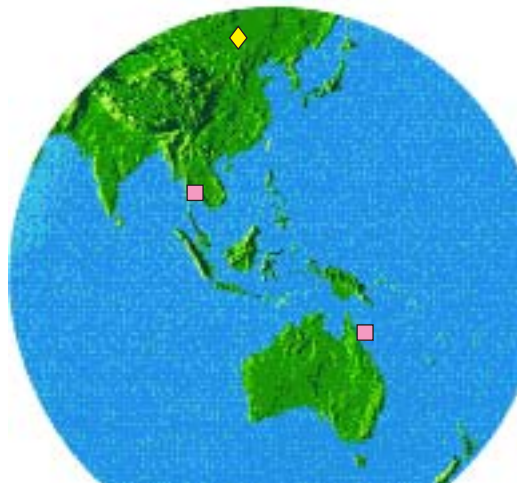

▲ Branch Offices & Warehouses

The Sealex Group
Green, England
Tel: +44 (0)845 450 4353

The Sealex Group
Cheshire, England
Tel: +44 (0)151 357 1551

The Sealex Group
Cardiff, Wales
Tel: +44 (0)2920 487646

■ Licensees

Euroguarco SpA
Arcola, Spain
Tel: +39 187 562611

Euro Trade Company
Alexandria, Egypt
Tel: +002 03 57 41 380

Eriks BV.
Rotterdam, Netherlands
Tel: +31 72 514 1514

Eriks Pte Ltd.
Singapore
Tel: +65 62 72 24 05

GHX, Inc.
Houston, TX, USA
Tel: +1 713 222 2231

Industrial Gasket & Supply
Torrance, CA, USA
Tel: +1 310 530 1771

Dooley Gasket and Seal Co.
Broomall, PA, USA
Tel: +1 610 328 2720

Lake Charles Rubber
Lake Charles, LA, USA
Tel: +1 337 433 1002

Special Piping Material Ltd.
Delta State, Nigeria
Tel: +234 53 254 767

Alliance Sealing Pty Ltd.
Brisbane, Australia
Tel: +61 (0)7 3212 5399

Note: Over 500 stocking distributors in over 40 countries strategically located to serve the world.

Flexitallic

SAFE

FLEXITALLIC GASKET DESIGN CRITERIA

Introduction

FLEXITALLIC, the world's leading manufacturer and supplier of static seals and the originator of the Spiral Wound Gasket, is committed to sealing solutions for today's industry. With greater emphasis than ever before placed on joint tightness, more attention is focused toward variables associated with the integrity of the bolted gasketed joint. Flexitallic Gasket Design Criteria manual offers the engineer and end user assistance in meeting the goal of providing fundamentally sound static sealing practice. Developed and collated by Flexitallic's worldwide team of engineers, this publication is the "engineer's handbook" of static seals technology.

Flexitallic has identified three factors which must be considered to achieve a leaktight joint

- Gasket Selection
- Gasket Design
- Gasket Installation

The Gasket

A gasket is a compressible material, or a combination of materials, which when clamped between two stationary members prevents the passage of the media across those members. The gasket material selected must be capable of sealing mating surfaces, resistant to the medium being sealed, and able to withstand the application temperatures and pressures.

How Does It Work?

A seal is effected by the action of force upon the gasket surface. This force which compresses the gasket, causes it to flow into the flange macro and micro imperfections. The combination of contact stress, generated by the applied force between the gasket and the flange, and the densification of the gasket material, prevents the escape of the confined fluid from the assembly.

Flange Imperfections

On seating, the gasket must be capable of overcoming the macro and micro imperfections. Macro defects are imperfections such as flange distortions, non-parallelism, scoring, troughs, while superficial imperfections such as minor scratches and minor scores are considered micro imperfections. Refer to ASME PCC-1 for information on acceptable flange blemishes.

Forces On The Gasket

In order to ensure the maintenance of the seal throughout the life expectancy of the assembly, sufficient stress must remain on the gasket surface to prevent leakage. The residual bolt load on the gasket should at all times be greater than the hydrostatic end force acting against it.

The hydrostatic end force is the force produced by the internal pressure which acts to separate the flanges.

Considerations For Gasket Selection

Many factors should be considered when selecting a gasket to ensure its suitability for the intended application. Gasket properties as well as flange configuration and application details are part of the selection process.

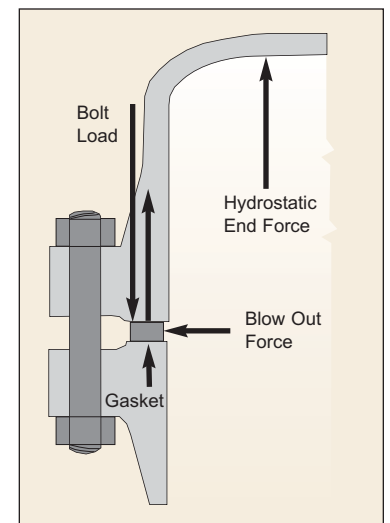
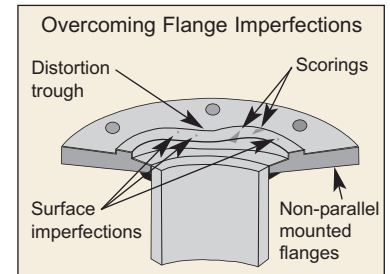

Internal Pressure is exerted against both the flange and the gasket.

SECTION I

Gasket Selection

Gaskets can be classified into three categories: soft cut, semi-metallic and metallic types.

The physical properties and performance of a gasket will vary extensively, depending on the type of gasket selected and the materials from which it is manufactured.

Physical properties are important factors when considering gasket design and the primary selection of a gasket type is based on the following:

- Temperature of the media to be contained
- Pressure of the media to be contained
- Corrosive nature of the application
- Criticality of the application

Soft Cut

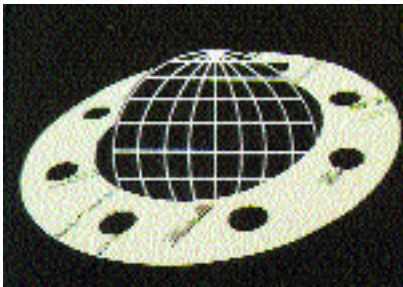

Sheet materials are used in low to medium pressure services. With careful selection these gaskets are not only suitable for general service but also for extreme chemical services and temperatures.

Types: Compressed Fiber Sheets, PTFE, Biaxially Orientated Reinforced PTFE, Graphite, Thermiculite®, Insulating Gaskets.

Semi-metallic

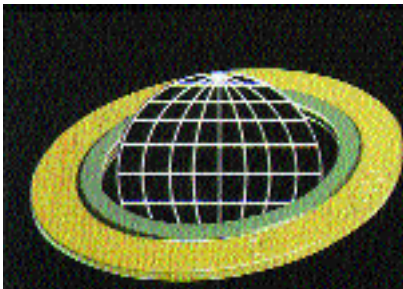

These are composite gaskets consisting of both metallic and non-metallic materials. The metal provides the strength and the resilience of the gasket and the non-metallic component provides the conformable sealing material. These gaskets are suitable for low and high pressure and temperature applications. A wide range of materials is available.

Types: Spiral Wound Gaskets, Flexpro Gaskets (grooved metal gasket with covering layers), Metal Jacketed Gaskets, MRG's (metal reinforced gaskets).

Metallic

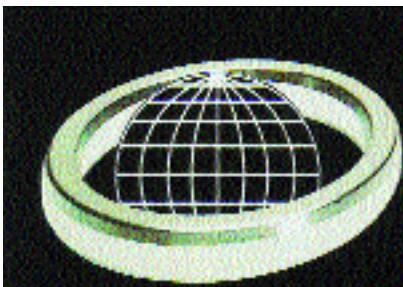

These gaskets can be fabricated in a variety of shapes and sizes recommended for use in high pressure/temperature applications. Except for weld ring gaskets, high loads are required to seat metallic gaskets, as they rely on the deformation or coining of the material into the flange surfaces.

Types: Ring Type Joints, Lens Rings, Weld Rings, Solid Metal Gaskets.

Gasket Selection

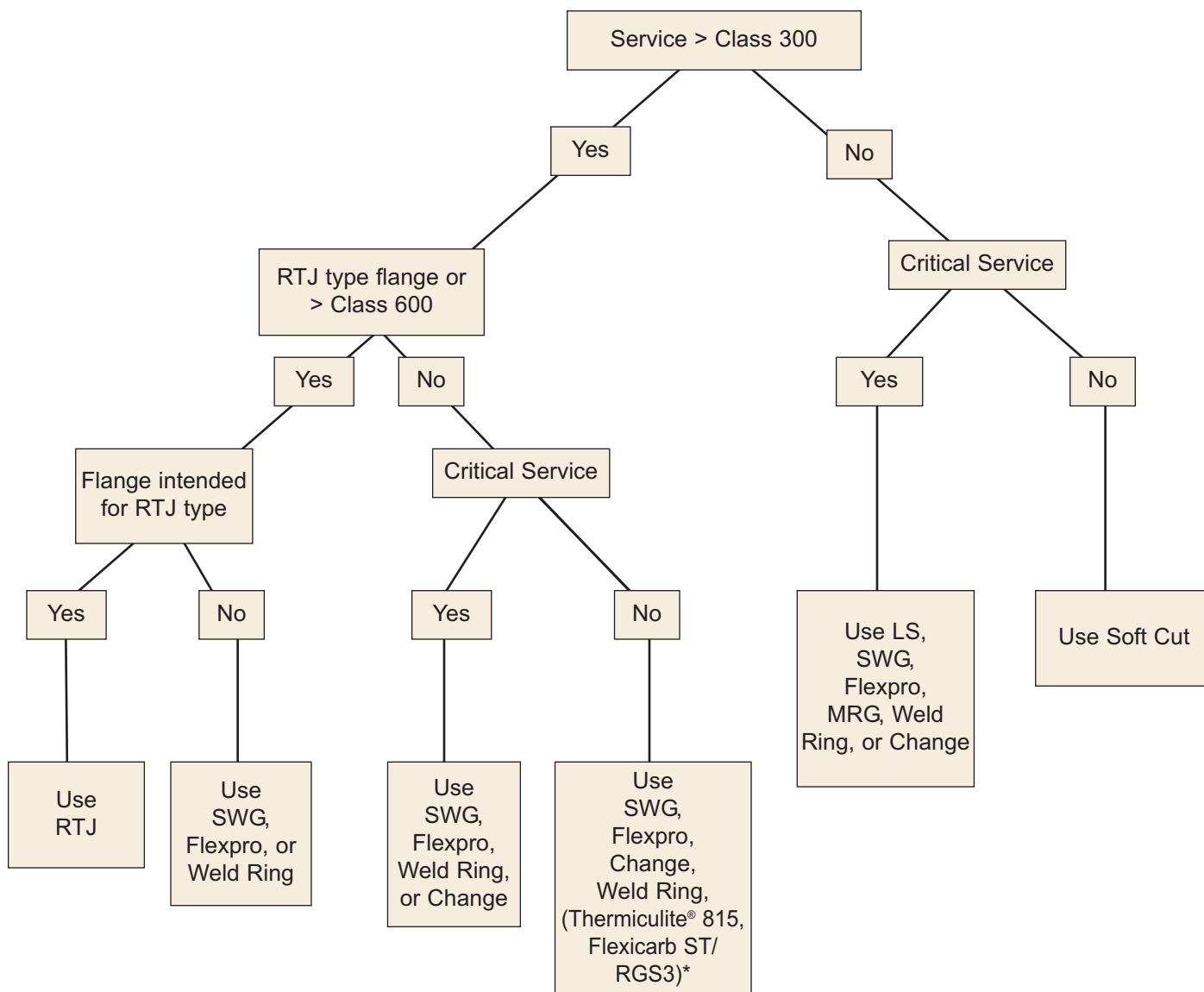

Select sealing material and metal type on basis of service, temperature, and medium.

Soft cut gaskets should always be of the minimum thickness consistent with the style of the flanges to be sealed, and compatible with the medium.

*High temperatures, but not higher than Class 300 pressure rating.

Change Gasket



EVERYTHING IS ABOUT TO CHANGE.

Introducing the spiral wound gasket that reinvents the category.

When Flexitallic invented the spiral wound gasket in 1912, there was nothing like it. 100 years of innovation later, we introduced the Change gasket.

The Change gasket design combines aspects of both a traditional spiral wound gasket and a kammprofile, improving upon both using reinvented winding wire 5-times thicker than traditional spiral wound wire. The new proprietary, heavy gauge metal wire is formed with a functional edge that simulates the serration profile of a grooved metal gasket (kammprofile) and held together via a unique and optimized laser welding process. The result – an incredibly robust and resilient semi-metallic gasket capable of out performing even our famed Heat Treated Inconel X-750 winding wire.

Cross Sectional Cutaway



Wound like a spiral. Faced like a kammprofile.

Heavy gauge winding wire

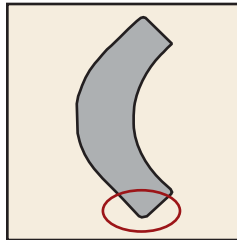

Edge simulates the serration of a kammprofile.



Profile of Change wire wound together beneath the facing.

A high level of stored energy gives the Change gasket superior recovery.

Recovery is essential to overcoming:

- Temperature swings inherent to the process
- Temperature swings from shutdowns - planned and unexpected (not every gasket is replaced)
- Differential thermal expansion (ex. Heat exchangers)
- Flange bending & stresses
- Pipe strain

Maximize gasket recovery to eliminate:

- Safety risks with hot-torquing
- Difficult assembly with spring washers

COMPRESSION VS. RECOVERY

18,000 PSI (124 MPa) GASKET STRESS

Gasket Style	% Compression	% Recovery*
Change	30	34
CGI, HT X-750	24	34
CGI, 316LSS	30	26
DJ	26	7
Kammprofile	25	6

*Recovery is a function of compression.

$$\% \text{ Recovery} = \frac{\text{distance recovered}}{\text{distance compressed}} \times 100$$

Recovery percentages are not directly comparable without taking Compression into consideration.

Gasket Constants

ASME m	2.5
ASME Y	6,400 psi
PVRC Gb	1,124 psi
PVRC a	0.25
PVRC Gs	16.1 psi

Change Gasket



24 Day, 24 Thermal Cycle Test

This end user specified extended thermal cycle test was designed to evaluate the performance of commonly used semi-metallic gaskets throughout industry. The requested test was to simulate the potential temperature excursions of a moderately efficient refinery between major outages with no bolted joint re-torque. The end user designed rig utilizes internal heating elements to better simulate a *real world* joint. Each gasket was cycled from ambient to 320°C (608°F) while sealing initial nitrogen pressure of 33 bar (478 psi). Leakage was measured via pressure drop with pass/fail criteria set to 1 bar (14.5 psi) max allowable loss.

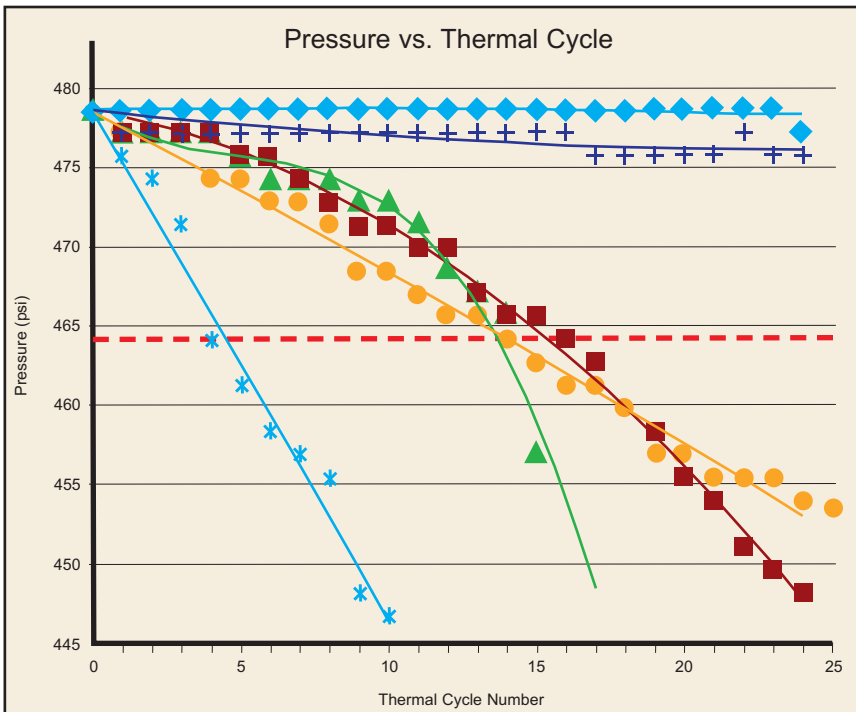

- ◆ Change
- + HT X750
- Kamm
- Spiral
- * CMG
- ▲ DJ
- - - Fail



Thermal Cycle Rig
 • 4” Class 300
 • B16 Studs
 • Internal heating element

The Change gasket lost only 1.5 psig total and even outperformed a spiral wound with Heat Treated Inconel X-750 (HT X750) winding wire.

Available Materials	Standard Windings	304 SS & 316 SS for 0.125" and 0.177" 347 SS and Inc 625 for 0.177"
	Filler & Facing	Flexible graphite - Standard PTFE and Thermiculite also available
Locating	Carbon Steel outer guide ring; tabs for larger OD	
Dimensions	Minimum Diameter	1" ID
	Maximum Diameter	80" + ID
Thickness	0.125" windings ≤ 24"	
	0.177" windings > 24"	
	Option of 0.125" between 24 to 40" (engineering discretion) 0.020" facing, all gaskets	
Maximum Radial Width	Up to 20" ID	3/4"
	20 to 40" ID	1/2"
	0.177" up to 80" ID	1"
Minimum Radial Width	3/8"	
Available Shapes	Round, Small oval	

Features	Spiral Wound Gasket	Flexpro (kamm-profile)	CHANGE Gasket
Blowout Resistant	Yes	Yes	Yes
Excellent Tightness	Yes	Yes	Yes
Excellent Recovery	Yes, improved with HT Inc X-750	No	Yes
Cyclic Conditions	Yes, HT Inc X750 Recommended	No	Yes
Good Handleability	No	Yes	Yes
Low Seating Stress	Not in all Sizes/Pressure Ratings	Yes	Yes
Use on Nubbin*	No	No	Yes

*Ask Flexitallic Engineering how the Change gasket has been successfully tested and used on flanges with nubbins.

Sheet Materials

With the shift to soft cut gaskets, gasket manufacturers have developed a myriad of products. Some of the initial materials developed proved inferior to their predecessors in regard to temperature, chemical resistance, creep resistance and sealing characteristics.

Flexitallic has developed a wide range of compressed fiber gasket sheet products. Some of these products have been fiber reinforced grades, manufactured by the traditional calendaring or sheeter process. Other product ranges are fiber-free and some of these materials have exceptionally good properties.



Flexitallic **Thermiculite**[®] is a versatile gasket material based upon the exfoliated vermiculite mineral. The product is available with a metal reinforced core or coreless and is designed for use at temperatures which exceed the capability of graphite based sheets.

The Flexitallic **Sigma**[®] range of biaxially orientated PTFE products has superb chemical resistance, far exceeding that of CAF. These materials can be used at temperatures from cryogenic to 260°C (500°F). Being intrinsically clean they are especially suitable for use in the food, pharmaceutical and electronics industries.

Flexicarb is the name given to Flexitallic's range of graphite based products. The range includes graphite foil as well as graphite laminates which contain reinforcing metal cores to overcome the fragility of the non-reinforced foil. Graphite products have excellent stress retention properties and are resistant to most chemical media with the exception of strong oxidizing agents. Reinforced Flexicarb sheets are the standard sealing product for many arduous applications in the petrochemical and refining industries.

The Flexitallic **SF** product ranges are rubber bound, fiber reinforced sheets made by the traditional calendaring or sheeter process. A wide range of fiber types are used, often in combination, ranging from cellulose, rockwool and glass to aramid and carbon.

Soft cut gasket sheets are typically used in Class 150 or Class 300 flanges. The temperature capability of the fiber/rubber products is highly thickness dependent, with thin gaskets having a wider service envelope than thicker ones.

Thermiculite®

Exclusive to Flexitallic, this revolutionary material comprised of chemically and thermally exfoliated vermiculite simulates the structure of exfoliated graphite, with one notable exception – it maintains integrity through a wide range of extreme temperatures. Vermiculite’s thin, flexible, soft plates can be exfoliated like graphite. They retain the sealability and low porosity of graphite, but unlike graphite, Flexitallic’s Thermiculite® sheet materials will not oxidize at high temperatures.



Vermiculite’s thin, flexible, soft plates can be exfoliated like graphite. They retain the sealability and low porosity of graphite, but Flexitallic’s new Thermiculite® sheet gaskets will not oxidize at high temperatures.

Graphite’s stress-loss due to oxidation has led to many examples of gasket failure. Independent testing of industrial grade graphite indicates a temperature limit of 650°F (340°C) for continuous service over 5 years. Thermiculite® however is thermally stable and maintains its integrity at temperatures up to 1800°F (982°C), protecting against thermal oxidation (see graph on page 9). Independent testing at TTRL (Tightness, Testing, and Research Laboratory) in Montreal illustrates Thermiculite’s excellent sealing properties and is shown on the following page.



Thermiculite® 715 Coreless Sheet

Product Range

Flexitallic has developed two exceptional sheet materials – Thermiculite® 715 and 815 – that demonstrate the broad range of chemical and temperature resistance of the vermiculite mineral. Both materials are extremely versatile, fire safe, and not susceptible to oxidation.

Performance Series - Thermiculite® 715

High performance coreless sheet material (i.e. no metallic reinforcement). Generally replaces compressed fiber sheet line – SF2401, 2420, 3300, 5000 – and graphite sheet. Available in thicknesses of 1/32”, 1/16” and 1/8” in cut gaskets and 60” x 60” sheet.

With its wide service capability, Thermiculite® 715 presents an opportunity for gasket standardization and inventory consolidation.

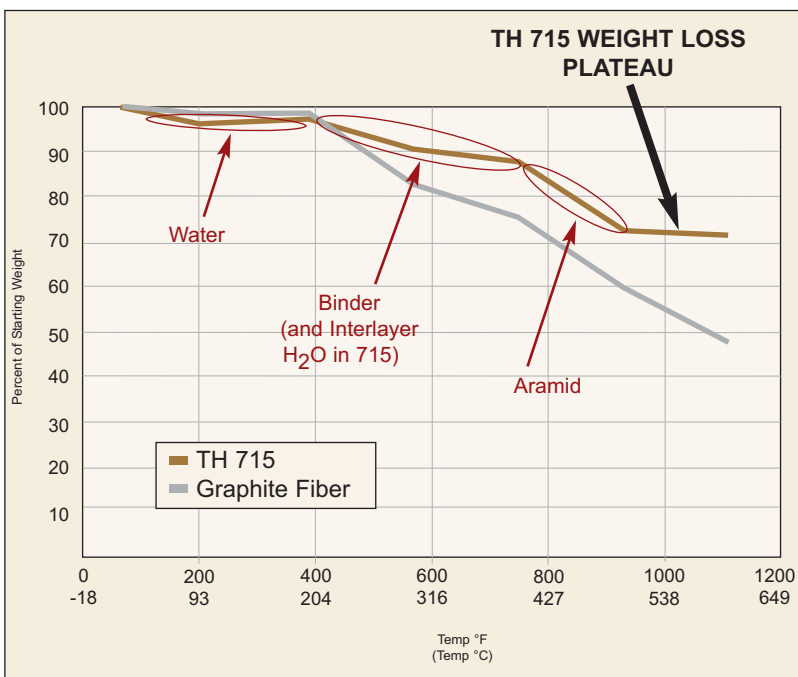

TGA, Thermiculite® 715 vs. Graphite Fiber - Graph shows a Thermogravimetric Analysis of TH 715 versus a well known and commonly used graphite fiber sheet. A TGA measures weight loss after exposure to air at elevated temperatures.

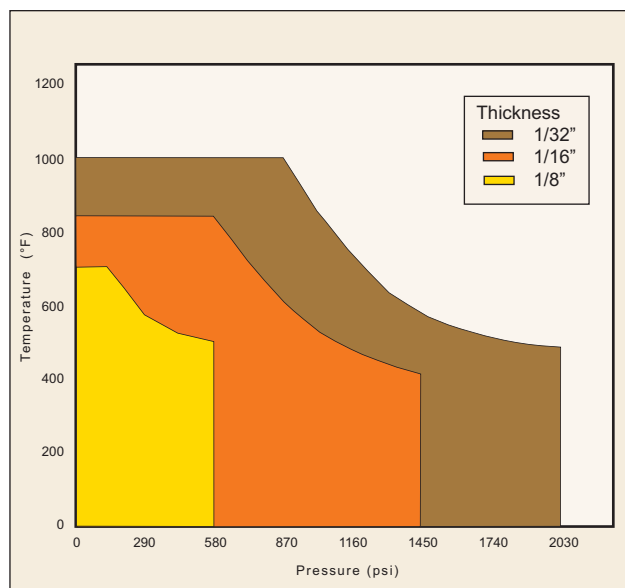

Flexitallic Thermiculite® 715 Pressure/Temperature Curve - Temperature and pressure guides cannot be used simultaneously and do not apply to all thicknesses. In keeping with Industry norm, Flexitallic suggests that cut gaskets be limited to Class 300 service max unless fully confined in a groove.

Thermiculite®

Critical Service Series - Thermiculite® 815

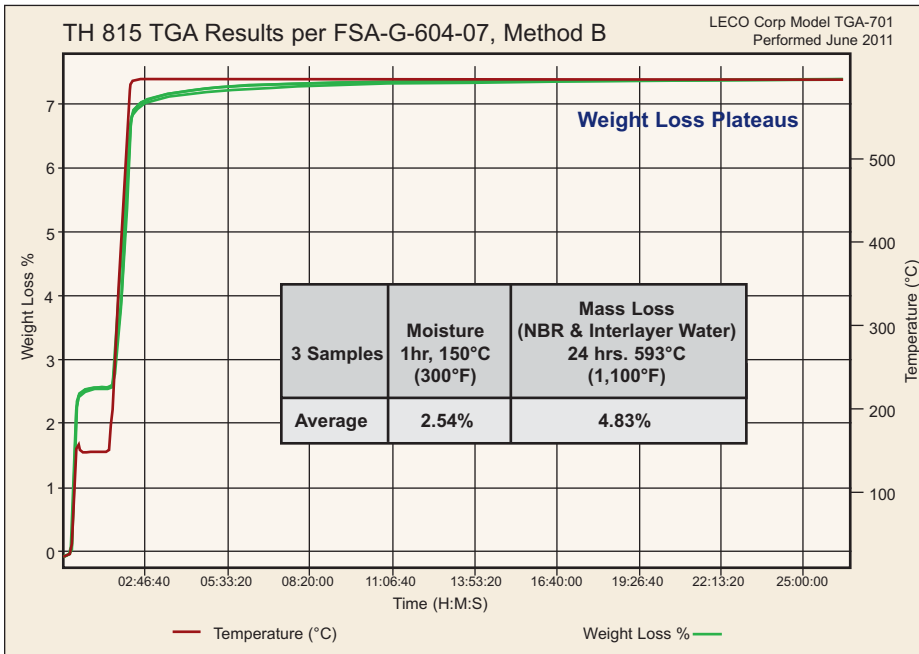

Thermiculite® 815 Tanged Sheet

High temperature sheet reinforced with a 0.004" 316 stainless steel tanged core. Available in thicknesses of 1/32", 1/16", and 1/8" in meter by meter (standard) and 60" x 60" sheet. Cut gaskets are available in all shapes and sizes.

Thermiculite® 815 is the original grade developed in the entire range of Thermiculite® series. This product has proven itself as an effective long-term sealing solution in the most versatile demanding industrial sealing applications.

Thermiculite 815 contains 4-5% NBR binder which is expelled in high temperature service. Based on thousands of successful in-service applications since 1997, this has not been found to significantly affect its sealing capability. Compared to graphite exposed to such high temperatures, especially for extended periods, Thermiculite maintains its mass after binder loss while graphite will continue to oxidize.

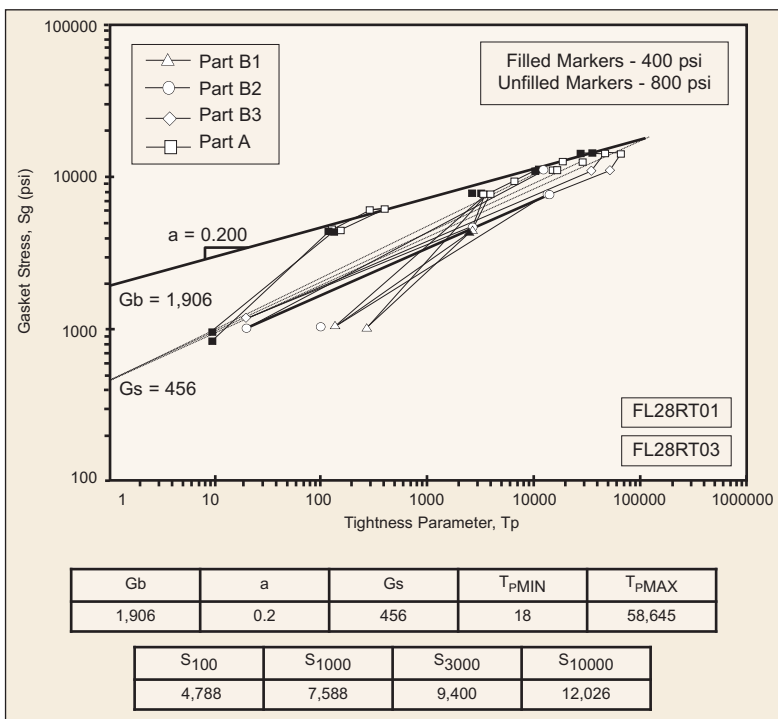

Room Temperature Tightness (ROTT) behavior characterization (Refer to page 48 for new method for determining factors.)

The above graphs are taken from the actual tests performed by TTRL.

Thermiculite® 815 chemical compatibility exceeds that of graphite and will successfully seal up to 1800°F (982°C). Thermiculite's high temperature capabilities make it ideal for use in combustion engine exhaust, nitrogen fertilizer manufacturing, steam, and much more. Unlike graphite, Thermiculite® resistance to galvanic corrosion will make it an excellent candidate for seawater and offshore cooling applications.

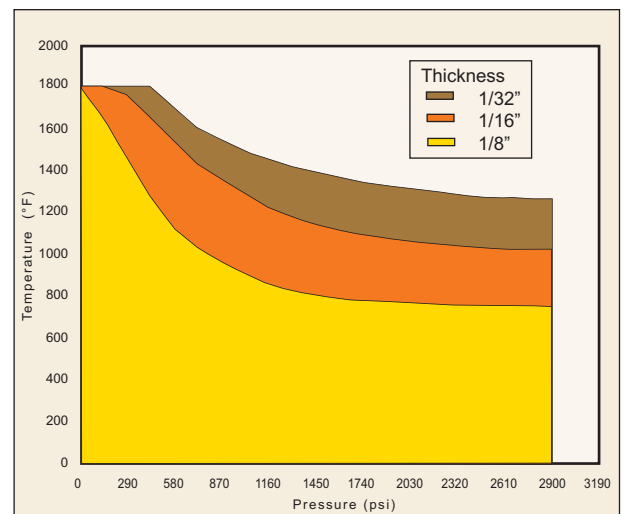

Flexitallic Thermiculite® 815 - Pressure/Temperature Curve

Thermiculite®

Sheet Property Summary

		Thermiculite® 715	Thermiculite® 815
Material Description			
Type		Coreless	0.004" 316LSS Tanged Reinforced
Color		Light Brown	Golden Brown
Properties			
Thickness	in. (mm)	1/16 (1.5)	1/16 (1.5)
Density	lb/ft ³ (g/cc)	112 (1.8)	75 (1.2) facing only
ASTM F 36 Compressibility	%	10	44
ASTM F36 Recovery	%	>45	9
ASTM F152 Cross Grain Tensile Strength	psi (MPa)	1595 (11)	n/a
ASTM F38 B Creep Relaxation 1/32"	%	21	23.5
ASTM F37 Liquid Leakage Fuel A 10 psi, Stress 1000 psi	ml/hr	0.55	n/a
BS 7531 Gas Permeability	ml/min	<1.0	0.13
BS 7531 Residual Stress	psi (MPa)	3,630 (25)	4,500 (31)
ASTM F146 Thickness Increase IRM 903	%	1.4	n/a
ASTM F146 Thickness Increase Fuel B	%	0.2	n/a
ASTM F146 Weight Increase IRM 903	%	17.7	n/a
ASTM F146 Weight Increase Fuel B	%	11.3	n/a
Maximum Temperature ¹	°F (°C)	850 (454)	1,800 (982)
Maximum Pressure ¹	psi (bar)	2,030 (140)	2,900 (200)
Gasket Constants			
ASME m		3.2	2.0
ASME Y	psi (MPa)	4,200 (29.0)	2,500 (17.25)
PVRC Gb	psi (MPa)	1,031 (7.1)	1,906 (13.1)
PVRC a		0.243	0.2
PVRC Gs	psi (MPa)	9.68 (0.07)	456 (3.1)
Tpmax		92,899	58,645

¹ Temperature and pressure guides cannot be used simultaneously and do not apply to all thicknesses. In keeping with Industry norms, Flexitallic suggests that cut gaskets be limited to Class 300 service max unless fully confined in a groove.

Note: For applications requiring gaskets that are totally free of organic content, please contact our engineering department to discuss Thermiculite 867.

PTFE Products - Sigma®

Flexitallic Sigma® offers outstanding chemical resistance while the unique manufacturing process results in a biaxially fibrillated structure ensuring high seal integrity in the most demanding applications.

While conventional PTFE-based sealing materials have long been the choice for superb chemical resistance, they are not ideally suited to achieve the maximum reduction of creep relaxation, or cold flow, in situations where seal integrity is paramount. Utilizing a unique manufacturing process exclusive to Flexitallic, we created SIGMA®, an innovatively-engineered line of biaxially orientated PTFE gasket materials.

Flexitallic Sigma® materials are inherently clean, making them suitable for use in industries where product contamination may be of concern such as food, pharmaceuticals and electronics. The components of the Flexitallic Sigma® range comply with the requirements of FDA regulations and the materials' outstanding chemical resistance make them suitable for sealing virtually every chemical medium across the whole pH range (0 - 14).

Sigma® products give unparalleled levels of sealing performance, especially when compared to conventional materials used in applications involving aggressive chemical media. These comparisons are supported by data generated by recognized, independent, international bodies in the field of static sealing. Sigma® products are ideally suited for applications where seal integrity is paramount, an important consideration where stringent emission controls may be in force.

All products in the Flexitallic Sigma® range are capable of sealing from cryogenic temperatures up to 500°F (260°C). For intermittent use even higher temperatures can be tolerated. Pressures from 1230 psi (8.5 MPa) down to vacuum can be accommodated. Furthermore, applications involving low gasket stresses such as glass lined, plastic and ceramic flanges, will not result in loss of sealing performance.

The Sigma® range of products has been engineered to be user friendly:

- Materials can be cut easily using conventional tools and techniques
- Complex geometric shapes can be accommodated, including narrow cross sections
- Gaskets are easy to install and remove
- All products are non-toxic

Product Range

Sigma® 500 - Enhanced compressibility for lower bolt loads achieved by the incorporation of hollow glass microspheres as the inorganic filler. Formulated for use on glass lined and ceramic flanges. Compatible with acids and alkalis at all but the highest concentrations. Sigma® 500 is listed in the Chlorine Institute Pamphlet 95.



Sigma® 511 - Standard compression sheet material reinforced with a silica filler. Intended for use with concentrated acids (except hydrofluoric acid) and with most general aggressive chemicals. Also suitable for medium concentrations of alkalis.

Sigma® 533 - Standard compression sheet material reinforced with barytes (barium sulphate) filler. Sigma® 533 is the preferred choice for sealing concentrated alkalis and is also compatible with Aqueous Hydrofluoric Acid below 49%. Restricted resistance to concentrated mineral acids. Sigma® 533 is listed in the Chlorine Institute Pamphlet 95.

Sigma® 588 - Highly compressible PTFE sheet without filler. Suitable for damaged contact surfaces. Layered structure enhances dimensional stability and ease of use. Layers bonded by direct sintering - no adhesive or potential leak path.

Sigma® 600 - Most compressibility for ultra-low bolt loads for plastic and glass lined equipment. Pigment and filler free - suitable for contamination sensitive applications. Universal - minimizes inventory and eliminates misapplication.

PTFE Products - Sigma®

Typical Properties

	SIGMA® 500	SIGMA® 511	SIGMA® 533	SIGMA® 588	SIGMA® 600
Material Description					
Composition	PTFE, Glass Microspheres	PTFE, Silica	PTFE, Barium Sulfate	PTFE	PTFE
Color	Blue	Fawn	Off white	White	White
Properties					
Thickness in (mm)	1/16 (1.5)	1/16 (1.5)	1/16 (1.5)	1/16 (1.5)	1/16 (1.5)
Density lb/ft³ (g/cc)	87 (1.4)	137 (2.2)	180 (2.9)	68 (1.1)	50 (0.8)
ASTM F36 Compressibility %	35	6	5	55	68
ASTM F36 Recovery %	44	44	43	24	5 ¹
ASTM F152 Cross Grain Tensile Strength psi (MPa)	2030 (14.0)	2175 (15.0)	2175 (15.0)	1450 (10.0)	1160 (8.0)
ASTM F38-B Creep Relaxation %	31	35	33	-	-
ASTM F37-A Sealability², 10 psi mL/hr	0.4	1.2	1.1	0.6	0.7
ASTM F37-A Sealability³, 50 psi mL/hr	0.7	1.8	1.8	1.5	1.2
DIN 52913 Residual Stress (347°F) MPa	30	30	28	28	34
DIN 3535 Nitrogen Gas Permeability mL/min	0.02	0.01	0.01	0.01	0.01
Maximum Pressure⁴	1088 - 1235 psi (depending on thickness)				
Maximum Temperature⁴	500°F				
Gasket Constants					
ASME m	1.4	1.4	1.4	1.4	1.4
ASME Y psi (MPa)	1885 (13.0)	2320 (16.0)	2320 (16.0)	1595 (11.0) ⁵	1595 (11.0) ⁶
PVRC G_b psi	4	209	115	317	405
PVRC a	0.80	0.36	0.38	0.29	0.27
PVRC G_s psi	11.5x10 ⁻²	4.9x10 ⁻³	6.5x10 ⁻⁵	1.1x10 ⁻⁶	24x10 ⁻²
Product Designation					
ASTM F104 Line Callout	F456110E11M5	F452110E11M6	F452110E11M6	F428130E21M4	F419000A9B2
Applications⁷	Ingredients in all SIGMA® grades comply with FDA requirements and can be cleaned for oxygen service.				
	Acids, Alkalis, all conc. of sulfuric acid, glass lined flanges	Most strong acids to general chemicals, oxygen, peroxide	Chlorine, Caustics, Alkalis to general chemicals, aqueous hydrofluoric acid below 49%	Plastic & glass lined flanges, Damaged surfaces, Replace envelope gaskets	Universal use, Ultra low loads, Plastic & glass lined flanges, Food & Pharm
Misapplications⁷	Anhydrous Hydrofluoric acid, Hydrogen fluoride gas, Fluorine, Molten Alkali metals (i.e. Sodium, Potassium, Lithium), Bromine trifluoride, Chlorine Trifluoride			Molten alkali metals, Fluorine, BrF ₃ , ClF ₃	
	Hydrofluoric acid, Aluminum fluoride, Concentrated caustics, Phosphoric acid	Hydrofluoric acid, Aluminum fluoride, Caustics, Phosphoric acid	Concentrated acids, Sulfuric acid, Oleum		

¹ Recovery is a function of compression. % Recovery = $\frac{\text{distance recovered}}{\text{distance compressed}} \times 100$. Recovery percentages are not directly comparable without taking Compression into consideration.

² Fuel A 10 psi; Gasket Stress 1000 psi

³ Fuel A 50 psi; Gasket Stress 1000 psi

⁴ Temperature and pressure guides cannot be used simultaneously and do not apply to all thicknesses. In keeping with Industry norms, Flexitallic suggests that cut gaskets be limited to Class 300 service max unless fully confined in a groove.

⁵ Y of 500 psi allowable for plastic flanges

⁶ Y of 700 psi allowable for plastic flanges

⁷ Refer to expanded Chemical Compatibility Chart on www.flexitallic.com.

PTFE Products - Fluoroseal

Fluoroseal is an expanded, pure PTFE sealing material. Supplied in the form of a highly conformable, flexible strip, it is ideal for use in applications involving non-standard flanges. This material offers both versatility and convenience and is therefore often used as a backup sealing option in situations where conventional gaskets are not immediately available.

Flexitallic Fluoroseal has outstanding chemical resistance and is inherently clean, making the product particularly suitable for sealing against aggressive media or in situations where feedstock contamination may be of concern.

The presence of an adhesive backed strip simplifies installation in large or complex flange applications, such as air conveying and solvent recovery systems.



Widths and Thicknesses of Fluoroseal At Full Compression

Sealant Thickness	Sealant Width	Compressed Thickness	Compressed Width
1/16" (1.5mm)	1/8" (3mm)	0.010" (0.3mm)	0.24" (6mm)
3/32" (2.0mm)	3/16" (5mm)	0.015" (0.4mm)	0.40" (10mm)
3/32" (2.5mm)	1/4" (7mm)	0.018" (0.45mm)	0.50" (13mm)
5/32" (4.0mm)	3/8" (10mm)	0.022" (0.55mm)	0.80" (20mm)
3/16" (5.0mm)	1/2" (12.5mm)	0.031" (0.8mm)	0.95" (24mm)
3/16" (5.0mm)	9/16" (14mm)	0.031" (0.8mm)	1.00" (25mm)
7/32" (6.0mm)	11/16" (17mm)	0.039" (1.0mm)	1.14" (29mm)
1/4" (6.0mm)	3/4" (19mm)	0.049" (1.25mm)	1.34" (34mm)
1/4" (6.0mm)	1" (25mm)	0.049" (1.25mm)	1.77" (45mm)

Fluoroseal is suitable for cryogenic application, and for temperatures up to 500°F (260°C).

Typical applications:

Hydraulic systems, pneumatic systems, water supply systems, ventilation ducts, fan housing, fume ducts, engine case doors etc.

Bolt Forces per Unit Length of Seal

Width (in.)	Gas Tight (lbf/in.)		Water Tight (lbf/in.)
	Smooth Flanges	Rough Flanges	
1/8	500	-	280
3/16	1260	-	280
1/4	1260	2520	390
3/8	1540	2800	390
1/2	1540	2940	390
5/8	1680	2940	420
3/4	1960	3360	420

Gas tight is based on compressed air at 600 psi.
Water tight is based on water at 30 psi.

Fluoroseal Universal Joint Sealant Nominal Sizes

Width (in.)	Spool Length (ft.)
1/8	100
3/16	75
1/4	50
3/8	25
1/2	15
5/8	15
3/4	15
1	15

Flexitallic Flexicarb®

The Flexitallic Flexicarb range of sheet sealing materials is manufactured from high purity exfoliated graphite flake, and is available with or without a reinforcing metallic core. The “standard” product range is based upon graphite with a minimum carbon content of 98% and, for nuclear applications, graphite with a minimum carbon content of 99.85% is available. The graphite foils can be attached to the reinforcing core by mechanical means or by the use of selected adhesives.



Flexicarb laminates are particularly suited for applications involving moderately high temperatures and pressures in a wide range of media. They are widely used in demanding industrial applications and in the petrochemical/refining industries. Because these products do not contain any rubber or polymeric binders they have the highest levels of stress retention, ensuring that gasket stress applied during assembly is maintained during service.

Graphite based products are resistant to most industrial chemicals but are susceptible to attack by oxidizing agents such as nitric acid. Sulfuric acid can also attack graphite at certain combinations of concentration and temperature. When selecting a graphite laminate for use in chemical service, consideration must be given to any possible reaction between the chemical medium and the reinforcing metallic core.



Oxidized sheet gasket

Oxidation

In air or in services where oxygen is present, graphite can burn away at high temperatures as it is converted to oxides of carbon. The rate at which this occurs depends on the graphite purity, temperature and the concentration of oxygen present. In a well bolted flange only the inner edge of the gasket will be exposed to oxygen in the pipe; the graphite will burn away very slowly with service life being affected by the land width of the gasket. In high temperature applications where the fluid being sealed does not contain oxygen, consideration must be given to possible attack of the graphite by oxygen from the external atmosphere surrounding the flange.



Oxidized spiral wound gasket

For long term service, work by independent testing has shown that maximum service temperature should be much lower than that usually quoted in manufacturers’ literature. This work has been validated by the Tightness Testing Research Laboratory (TTRL) at Ecole Polytechnique in Montreal on behalf of the Pressure Vessel Research Council (PVRC). The TTRL report included the maximum service temperatures for various periods of service for graphite sheet gaskets as shown in the table.

Product Range

Flexicarb Laminated Sheet LS (GS 600*) - Homogeneous Graphite foil. This product is fabricated by laminating homogenous sheets of graphite foil.

Required Service Life Years	Maximum Service Temperature	
	°C	°F
1	370	691
3	330	630
5	320	610
10	305	580

Flexicarb SR (RGS 4*) - This laminate contains a 0.002” (0.05mm) thick 316 stainless steel core with adhesively bonded graphite facing.

Flexicarb ST (RGS 3*) - This laminate contains a tanged 0.004” (0.1mm) thick 316 stainless steel core onto which the graphite faces are mechanically attached. This gasket is used where high pressures have to be contained and is particularly suitable for use in superheated steam service.

Flexicarb NR (RGS 1*) - Laminate in which the graphite is adhesively bonded onto a 0.0005” (13 micron) thick nickel core using a chemically resistant nitrile phenolic adhesive.

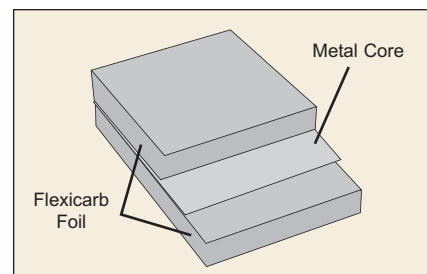

* UK designation

Compressed Fiber Gasket

Flexitallic Compressed Fiber Sheet Application Guide

Material	Composition	Applications	Relative Cost (1 = lowest)
SF 2401	Synthetic/NBR	General purpose sheet for steam, water, gases, oils, mild solvents and alkalis; max temp 350 to 662°F (177 - 350°C) min temp -40°F (-40°C)	1
SF 2420	Aramid/SBR	Same as SF 2401 except SBR binder; ideal for the paper making Industry; max temp 350 - 750°F (177 - 400°C) min temp -40°F (-40°C)	2
SF 3300	Aramid/Glass/NBR	Top Grade sheet for general industrial applications; max temp 350 - 825°F (177 - 440°C) min temp -40°F (-40°C)	3
SF 3500	Aramid/Glass/NBR	More aramid fiber than SF 3300 for increased strength in split casing pumps; max temp 440°C (825°F) @ 1/64" thk min temp -40°F (-40°C)	4
SF 5000	Carbon/Aramid/NBR	Especially suitable for sealing caustic liquors; max temp 177 - 440°C (350 - 825°F) min temp -40°F (-40°C)	5

Additional grades available upon request. Please inquire with Engineering.

Temperature-Pressure Limitations

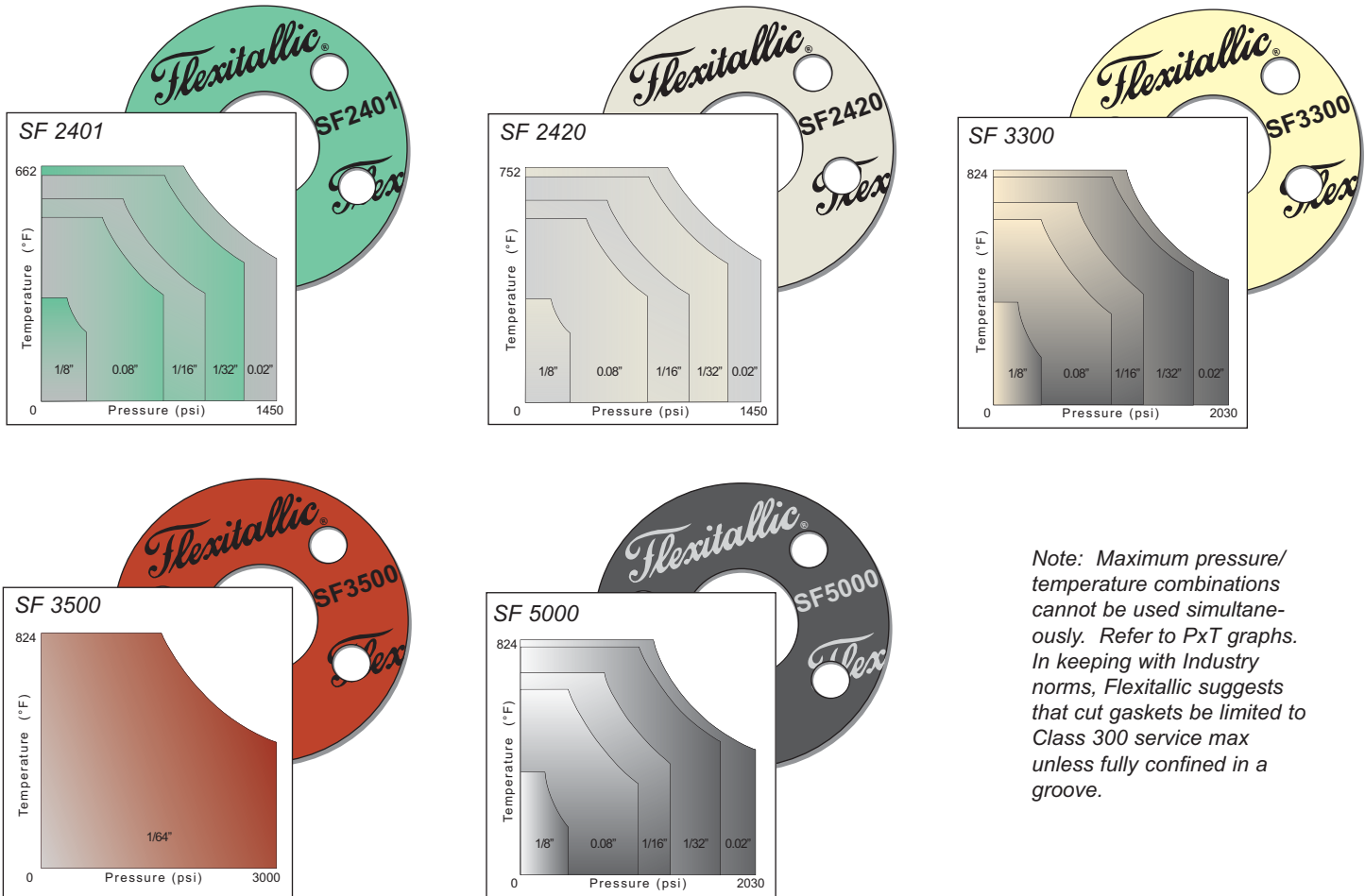

Note: Maximum pressure/temperature combinations cannot be used simultaneously. Refer to PxT graphs. In keeping with Industry norms, Flexitallic suggests that cut gaskets be limited to Class 300 service max unless fully confined in a groove.

Core4 Sheet Products

Simplicity. Savings. Efficiency.

In a market survey of End Users and Distributors, gasket universality was cited as the third most important characteristic above price, availability and source. Too many types of gaskets/gasket material were cited as a significant challenge faced by those surveyed.

End user concerns centered on less experienced contract workers installing the wrong gasket in the wrong application. Distributors listed sheet utilization and reduced stocking levels as an advantage to sheet product universality.

Flexitallic's Core4 sheet products will reduce inventory and choice reduction maximizing performance and compatibility while still achieving cost effectiveness.

- No more gasket failures caused by installing the wrong gasket
- Simplify materials on the shelf
- Reduce inventory



SF 2401

Medium quality, cost effective, compressed, fiber sheet material. Based on a blend of aramid and inorganic fiber with a high quality nitrile binder system. Suitable for use with oils, solvents, gases, hot and cold water, low pressure steam and many dilute acids and alkalis.

Max T (1/16")	662°F (350°C)
Max P (1/16")	870 psig (60 bar)
ASME m	3.2
ASME Y	2900 psi (20 MPa)



Thermiculite® 815

Exfoliated Vermiculite based, high temperature sheet reinforced with a 0.004", 316 stainless steel tanged core. Provides total freedom from oxidation. Chemical compatibility exceeds graphite. Fire safe with proven global track record.

Max T	1800°F (982°C)
Max P	2900 psi (200 bar) (Class 150 - 300)
ASME m	2.0
ASME Y	2500 psi



Thermiculite® 715

Exfoliated Vermiculite based sheet better suited for elevated temperatures than aramid, carbon and graphite fiber, and PTFE sheets. Demonstrates good load bearing properties and flexibility, is non-contaminating and fire safe, and has good chemical resistance.

Max T (1/16")	850°F (454°C)
Max P (1/16")	2030 psi (140 bar)
ASME m	3.2
ASME Y	4200 psi (30 MPa)



Sigma® 600

A universal PTFE sheet with the widest chemical resistance for use with both low and high bolt loads. FDA compliant, non-contaminating, and cold flow resistant. A single gasket replacement for metallic and non-metallic flange applications.

Max T	500°F (260°C)
Max P (1/16")	1235 psig (8.5 MPa)
ASME m	1.4
ASME Y	1595 psi (11 MPa)



Contact a Flexitallic Representative or your local Flexitallic Allied Distributor to find out how you can begin the process of simplifying your sheet gasket needs.

Sheet Materials Chemical Compatibility Chart

Based on free immersion at room temperature.	Sigma®				Thermiculite®		Flexicarb (FG)	SF2401 SF3300 SF3500	SF2420	SF5000
	500	511	533	588 600	715	815				
Acetic acid glacial	Y	Y	Y	Y	Y	Y	Y	Y	Y	Y
Acetone	Y	Y	Y	Y	Y	Y	Y	Y	Y	Y
Acetylene	Y	Y	Y	Y	Y	Y	Y	Y	Y	Y
Acrylic acid	Y	Y	Y	Y	Y	Y	Y	Y	Y	Y
Acrylonitrile	Y	Y	Y	Y	Y	Y	Y	Y	O	Y
Air	Y	Y	Y	Y	Y	Y	Y	Y	Y	Y
Alkaline lye	Y	Y	Y	Y	Y	Y	Y	O	O	Y
Aluminum chloride	Y	Y	Y	Y	Y	Y	Y	O	O	O
Ammonia gas	Y	Y	Y	Y	Y	Y	Y	Y	Y	Y
Ammonia	Y	Y	Y	Y	Y	Y	Y	Y	Y	Y
Amyl acetate	Y	Y	Y	Y	Y	Y	Y	Y	O	Y
Amyl alcohol	Y	Y	Y	Y	Y	Y	Y	Y	O	Y
Aniline	Y	Y	Y	Y	Y	Y	Y	O	O	O
Aqua-regia	Y	Y	Y	Y	O	Y	N	N	N	N
Aviation fuel	Y	Y	Y	Y	Y	Y	Y	Y	O	Y
Beer	Y	Y	Y	Y	Y	Y	Y	Y	Y	Y
Benzene	Y	Y	Y	Y	Y	Y	Y	Y	O	Y
Benzoyl chloride	Y	Y	Y	Y	Y	Y	Y	Y	O	Y
Biphenyl	Y	Y	Y	Y	Y	Y	Y	Y	Y	Y
Blast furnace gas	Y	Y	Y	Y	Y	Y	Y	Y	Y	Y
Bleach (solution)	Y	Y	Y	Y	Y	Y	Y	Y	Y	Y
Boiler feed water	Y	Y	Y	Y	Y	Y	Y	Y	Y	Y
Brine	Y	Y	Y	Y	Y	Y	Y	Y	Y	Y
Bromine	Y	Y	Y	Y	N	N	O	N	N	N
Calcium chlorate	Y	Y	Y	Y	Y	Y	Y	N	N	N
Capro-lactam	Y	Y	Y	Y	Y	Y	Y	Y	O	Y
Carbolic Acid	Y	Y	Y	Y	Y	Y	Y	N	N	N
Carbon dioxide	Y	Y	Y	Y	Y	Y	Y	Y	Y	Y
Carbon disulphide	Y	Y	Y	Y	Y	Y	Y	N	N	N
Carbon monoxide	Y	Y	Y	Y	Y	Y	Y	Y	Y	Y
Carbon tetrachloride	Y	Y	Y	Y	Y	Y	Y	Y	O	Y
Chile saltpetre	Y	Y	Y	Y	Y	Y	Y	Y	Y	Y
Chlorine dry	Y	Y	Y	Y	Y	Y	Y	N	N	N
Chlorine wet	Y	Y	Y	Y	O	Y	Y	N	N	N
Chlorinated hydrocarbons	Y	Y	Y	Y	Y	Y	Y	O	O	O
Chloroacetic acid	Y	Y	Y	Y	Y	Y	Y	O	O	O
Chloro benzene	Y	Y	Y	Y	Y	Y	Y	Y	O	Y
Chromic acid	Y	Y	Y	Y	O	Y	O	N	N	N
Copper sulphate	Y	Y	Y	Y	Y	Y	Y	Y	Y	Y
Creosote	Y	Y	Y	Y	Y	Y	Y	Y	O	Y
Cresol	Y	Y	Y	Y	Y	Y	Y	N	N	N
Crude oil	Y	Y	Y	Y	Y	Y	Y	Y	Y	Y
Cyclohexanol	Y	Y	Y	Y	Y	Y	Y	Y	O	Y
1,4-Dichlorobenzene	Y	Y	Y	Y	Y	Y	Y	O	N	O
Diesel Oil	Y	Y	Y	Y	Y	Y	Y	Y	Y	Y
Dowtherm	Y	Y	Y	Y	Y	Y	Y	Y	Y	Y
Dye Liquor	Y	Y	Y	Y	Y	Y	Y	O	O	O
Ethyl acetate	Y	Y	Y	Y	Y	Y	Y	Y	O	Y
Ethyl alcohol	Y	Y	Y	Y	Y	Y	Y	Y	Y	Y
Ethylene glycol	Y	Y	Y	Y	Y	Y	Y	Y	Y	Y
Ethylene oxide	Y	Y	Y	Y	Y	Y	Y	O	O	O
Ethyl ether	Y	Y	Y	Y	Y	Y	Y	Y	Y	Y

LEGEND:
 Y = Suitable for Application
 O = Suitability Depends On Operating Conditions
 N = Not Suitable

For expanded version, visit us at www.flexitallic.com.

Sheet Materials Chemical Compatibility Chart

Based on free immersion at room temperature.	Sigma®				Thermiculite®		Flexicarb (FG)	SF2401 SF3300 SF3500	SF2420	SF5000
	500	511	533	588 600	715	815				
Ethylene	Y	Y	Y	Y	Y	Y	Y	Y	Y	Y
Ethylene chloride	Y	Y	Y	Y	Y	Y	Y	N	N	N
Fatty acids	Y	Y	Y	Y	Y	Y	Y	Y	Y	Y
Ferric chloride	Y	Y	Y	Y	Y	Y	O	Y	Y	Y
Fluorine	N	N	N	N	N	N	Y	N	N	N
Fluorosilicic acid	Y	Y	Y	Y	N	N	Y	N	N	N
Formaldehyde	Y	Y	Y	Y	Y	Y	Y	Y	O	Y
Formic acid 85%	Y	Y	Y	Y	Y	Y	Y	O	O	O
Formic acid 10%	Y	Y	Y	Y	Y	Y	Y	Y	O	O
Freons	Y	Y	Y	Y	Y	Y	Y	O	O	O
Gas oil	Y	Y	Y	Y	Y	Y	Y	Y	Y	Y
Gasoline	Y	Y	Y	Y	Y	Y	Y	Y	Y	Y
Heating oil	Y	Y	Y	Y	Y	Y	Y	Y	Y	Y
Hydraulic oil (glycol)	Y	Y	Y	Y	Y	Y	Y	Y	Y	Y
Hydraulic oil (mineral)	Y	Y	Y	Y	Y	Y	Y	Y	Y	Y
Hydraulic oil (phosphate ester)	Y	Y	Y	Y	Y	Y	Y	Y	Y	Y
Hydrazine	Y	Y	Y	Y	Y	Y	Y	Y	Y	Y
Hydrocarbons (aromatic)	Y	Y	Y	Y	Y	Y	Y	Y	O	Y
Hydrocarbons aliphatic (sat.)	Y	Y	Y	Y	Y	Y	Y	Y	Y	Y
Hydrocarbons aliphatic (unsat.)	Y	Y	Y	Y	Y	Y	Y	Y	O	Y
Hydrochloric acid (37% HCl)	Y	Y	Y	Y	O	Y	Y	N	N	N
Hydrofluoric acid	N	N	O	Y	N	N	Y	N	N	N
Hydrogen	Y	Y	Y	Y	Y	Y	Y	Y	Y	Y
Hydrogen chloride	Y	Y	Y	Y	Y	Y	Y	N	N	N
Hydrogen fluoride	N	N	O	Y	N	N	Y	N	N	N
Hydrogen peroxide	Y	Y	Y	Y	O	Y	O	N	N	N
Hydrogen sulfide	Y	Y	Y	Y	Y	Y	Y	Y	Y	Y
Isopropyl acetate	Y	Y	Y	Y	Y	Y	Y	Y	O	Y
Isopropyl alcohol	Y	Y	Y	Y	Y	Y	Y	Y	Y	Y
Kerosene	Y	Y	Y	Y	Y	Y	Y	Y	Y	Y
Lime	Y	Y	Y	Y	Y	Y	Y	Y	Y	Y
Lubrication oil	Y	Y	Y	Y	Y	Y	Y	Y	Y	Y
Machine oil	Y	Y	Y	Y	Y	Y	Y	Y	Y	Y
Magnesium sulphate	Y	Y	Y	Y	Y	Y	Y	Y	Y	Y
Malic acid	Y	Y	Y	Y	Y	Y	Y	Y	Y	Y
Methane	Y	Y	Y	Y	Y	Y	Y	Y	Y	Y
Methyl acrylate	Y	Y	Y	Y	Y	Y	Y	Y	O	Y
Methyl alcohol	Y	Y	Y	Y	Y	Y	Y	Y	Y	Y
Methyl isobutyl ketone	Y	Y	Y	Y	Y	Y	Y	Y	O	Y
Methyl methacrylate	Y	Y	Y	Y	Y	Y	Y	Y	O	Y
Methylene chloride	Y	Y	Y	Y	Y	Y	Y	N	N	N
Mineral oil	Y	Y	Y	Y	Y	Y	Y	Y	Y	Y
Mobiltherm	Y	Y	Y	Y	Y	Y	Y	Y	Y	Y
Naphthalene	Y	Y	Y	Y	Y	Y	Y	Y	Y	Y
Natural gas	Y	Y	Y	Y	Y	Y	Y	Y	Y	Y
Nitric acid (concentrated 50%)	Y	Y	Y	Y	O	Y	O	N	N	N
Nitric acid (fuming 95%)	Y	Y	Y	Y	N	Y	N	N	N	N
Nitrogen	Y	Y	Y	Y	Y	Y	Y	Y	Y	Y
Oleum	Y	Y	N	Y	O	Y	N	N	N	N
Oxygen	Y	Y	Y	Y	Y	Y	O	Y	Y	Y
Paraffin	Y	Y	Y	Y	Y	Y	Y	Y	Y	Y
Pentachlorophenol	Y	Y	Y	Y	Y	Y	Y	Y	Y	Y

LEGEND:
 Y = Suitable for Application
 O = Suitability Depends On Operating Conditions
 N = Not Suitable

For expanded version, visit us at www.flexitallic.com.

Sheet Materials Chemical Compatibility Chart

Based on free immersion at room temperature.	Sigma®				Thermiculite®		Flexicarb (FG)	SF2401 SF3300 SF3500	SF2420	SF5000
	500	511	533	588 600	715	815				
Perchloric acid	Y	Y	Y	Y	N	Y	N	N	N	N
Petroleum	Y	Y	Y	Y	Y	Y	Y	Y	Y	Y
Phenol	Y	Y	Y	Y	Y	Y	Y	N	N	N
Phosgene	Y	Y	Y	Y	Y	Y	Y	N	N	N
Phosphoric acid (concentrated)	O	O	Y	Y	O	Y	Y	N	N	N
Phosphoric acid (dilute)	Y	Y	Y	Y	Y	Y	Y	Y	Y	Y
Phosphorous	Y	Y	Y	Y	O	O	O	N	N	N
Phthalic anhydride	Y	Y	Y	Y	Y	Y	Y	Y	Y	Y
Potassium hydroxide	O	O	Y	Y	Y	Y	Y	O	O	Y
Potassium nitrate	Y	Y	Y	Y	Y	Y	Y	Y	Y	Y
Potassium permanganate	Y	Y	Y	Y	Y	Y	Y	Y	Y	Y
Producer gas	Y	Y	Y	Y	Y	Y	Y	Y	Y	Y
Pyridine	Y	Y	Y	Y	Y	Y	Y	N	N	N
Sea water	Y	Y	Y	Y	Y	Y	Y	Y	Y	Y
Silicone oil	Y	Y	Y	Y	Y	Y	Y	Y	Y	Y
Soda ash	Y	Y	Y	Y	Y	Y	Y	Y	Y	Y
Sodium bi-carbonate	Y	Y	Y	Y	Y	Y	Y	Y	Y	Y
Sodium carbonate	Y	Y	Y	Y	Y	Y	Y	Y	Y	Y
Sodium cyanide	Y	Y	Y	Y	Y	Y	Y	Y	Y	Y
Sodium hydroxide (40%)	Y	N	Y	Y	O	Y	Y	N	N	Y
Sodium hydroxide (dilute)	Y	Y	Y	Y	Y	Y	Y	Y	Y	Y
Sodium hypochlorite	Y	Y	Y	Y	Y	Y	Y	Y	Y	Y
Sodium nitrate	Y	Y	Y	Y	Y	Y	Y	Y	Y	Y
Starch	Y	Y	Y	Y	Y	Y	Y	Y	Y	Y
Steam	Y	Y	Y	Y	Y	Y	Y	Y	Y	Y
Steam condensate	Y	Y	Y	Y	Y	Y	Y	Y	Y	Y
Styrene	Y	Y	Y	Y	Y	Y	Y	Y	O	Y
Sulphur	Y	Y	Y	Y	Y	Y	Y	Y	Y	Y
Sulphur dioxide	Y	Y	Y	Y	Y	Y	Y	Y	Y	Y
Sulphur trioxide	Y	Y	Y	Y	Y	Y	N	N	N	N
Sulphuric acid (concentrated)	Y	Y	O	Y	O	Y	N	N	N	N
Sulphuric acid (fuming)	Y	Y	N	Y	O	Y	N	N	N	N
Tar	Y	Y	Y	Y	Y	Y	Y	Y	Y	Y
Turpentine	Y	Y	Y	Y	Y	Y	Y	Y	Y	Y
Toluene	Y	Y	Y	Y	Y	Y	Y	Y	O	Y
Towns gas	Y	Y	Y	Y	Y	Y	Y	Y	Y	Y
Transformer oil	Y	Y	Y	Y	Y	Y	Y	Y	Y	Y
Tributyl phosphate	Y	Y	Y	Y	Y	Y	Y	Y	Y	Y
Triethanolamine	Y	Y	Y	Y	Y	Y	Y	Y	Y	Y
Urea	Y	Y	Y	Y	Y	Y	Y	Y	Y	Y
Vegetable Oil	Y	Y	Y	Y	Y	Y	Y	Y	Y	Y
Vinyl acetate	Y	Y	Y	Y	Y	Y	Y	Y	O	Y
Vinyl chloride	Y	Y	Y	Y	Y	Y	Y	O	O	O
Vinylidene chloride	Y	Y	Y	Y	Y	Y	Y	O	O	O
Water	Y	Y	Y	Y	Y	Y	Y	Y	Y	Y
Water condensate	Y	Y	Y	Y	Y	Y	Y	Y	Y	Y
Water distilled	Y	Y	Y	Y	Y	Y	Y	Y	Y	Y
Whisky	Y	Y	Y	Y	Y	Y	Y	Y	Y	Y
Wine	Y	Y	Y	Y	Y	Y	Y	Y	Y	Y
White Spirit	Y	Y	Y	Y	Y	Y	Y	Y	Y	Y
Xylene	Y	Y	Y	Y	O	O	Y	N	N	N

LEGEND:
 Y = Suitable for Application
 O = Suitability Depends On Operating Conditions
 N = Not Suitable

For expanded version, visit us at www.flexitallic.com.

Insulating Sets

Insulating sets comprise of a phenolic laminate or neoprene faced phenolic laminate gasket (Style NCA and NCB only) which is located between the flange sealing faces, phenolic laminate bolt sleeves, two insulating washers per bolt for maximum protection and two plated mild steel washers per bolt. Stainless steel washers can be supplied upon request.

Insulating sets are essentially used for pipeline flange corrosion protection, where a seal is required between dissimilar flange materials. The use of dissimilar metallic flanges with a conductive gasket material accompanied with a suitable electrolyte may set up a galvanic cell which will corrode the anodic metal. Insulating sets are also used to electrically isolate flange joints, preventing the flow of electrostatic charge along pipelines.

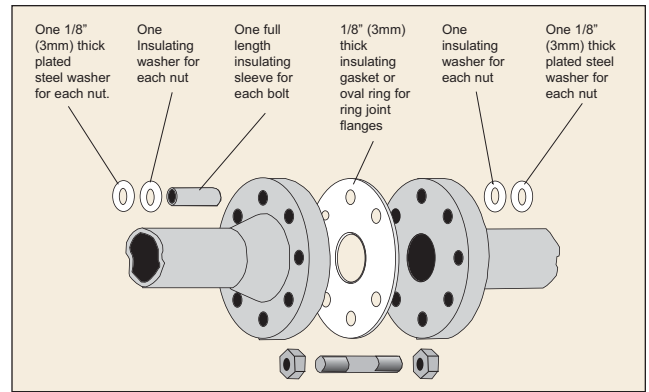

There are three standard styles of insulating sets available to suit raised face, flat face, and ring grooved flanges, as illustrated below.

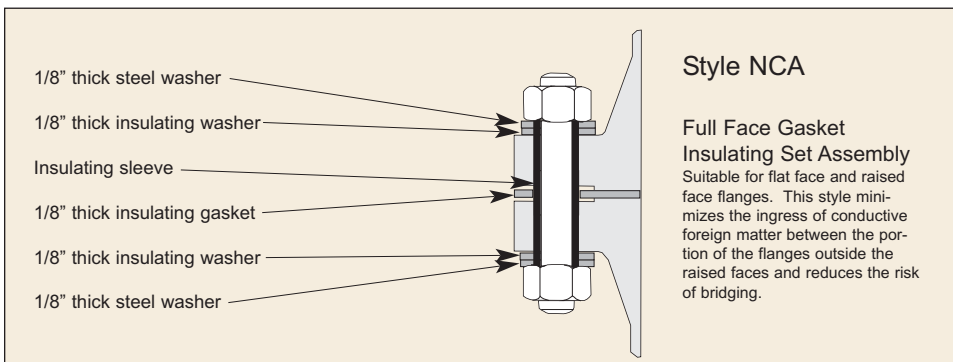

Standard Styles

It is also recommended that for complete electrical insulation protection that self-adhesive tape is wrapped around the outside diameter of the flange to prevent the ingress of foreign matter.

With style NCA and NCB insulating sets it is imperative that the bore of the gasket is equal to that of the pipe. This will prevent any foreign matter from accumulating

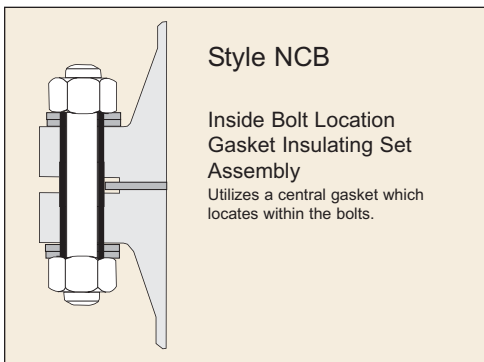

in the annular space between the bore of the gasket and the bore of the pipe thus preventing bridging.

Phenolic laminate provides excellent insulating properties as well as corrosion resistance. See table for typical properties of 1/8" (3mm) thick phenolic. Other gasket styles such as Sigma® and compressed fiber sheets may also be suitable.

As standard, Flexitallic insulating kits are dimensioned to suit schedule 80 pipe suitable for use on standard and non-standard flange assemblies up to and inclusive of Class 2500.

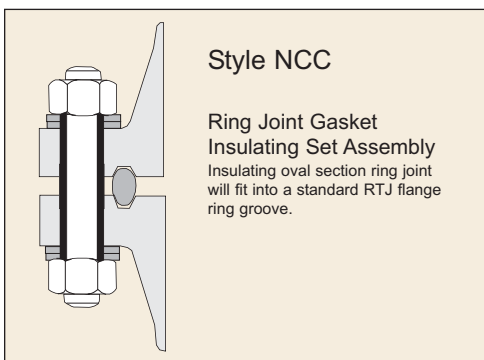

Typical Properties of Phenolic Gaskets	
Maximum axial compressive stress	45,700 psi (315MPa)
Axial electric strength in oil @ 190°F (90°C)	58kV/in (23kV/cm)
Maximum operating temperature	250°F (120°C)
Minimum operating temperature	-76°F (-60°C)

Insulating Sets

Flexpro Insulating Gaskets

Common sheet gaskets used to insulate low pressure low temperature applications can not tolerate internal high pressures or high temperature media. Common insulating gaskets are limited to 250°F maximum and are usually only suitable for 150 and 300 pressure classes.

Flexitallic special Insulating Flexpro gaskets are capable of sealing very high internal pressures (as high as Class 2500). The solid metal core gives the gasket excellent blowout resistance and stability for ease of handling and installation. The soft, relatively thin facing material requires only a low minimum seating stress in combination with minimal relaxation compared to other soft sheet materials, such as skived Teflon. The low minimum seating stress ($y = 2,500$ PSI) makes it ideal for use with low pressure flanges or flanges with limited bolting, yet with the solid metal core, the gasket can support high stresses without crushing of the gasket.

Sigma facing can be used for temperatures as high as 500°F. Sigma is the Flexitallic brand name for biaxially reinforced PTFE with low creep relaxation.

For higher temperature applications Thermiculite facing is recommended. Thermiculite is Flexitallic brand name for a proprietary vermiculite based material capable of temperatures as high as 1800°F.

- Available for standard or specially designed flanges
- Soft conformable facing
- Robust, easy to handle
- Blowout resistant
- Creep resistant; better torque retention
- May be refurbished by Flexitallic
- Available with full face design

Typical Applications

Offshore installations, sea water environments, hydrocarbon service, chemical installations, oil refining pipelines requiring galvanic corrosion protection and electrical insulation.

**Sigma 500 can be used also.*

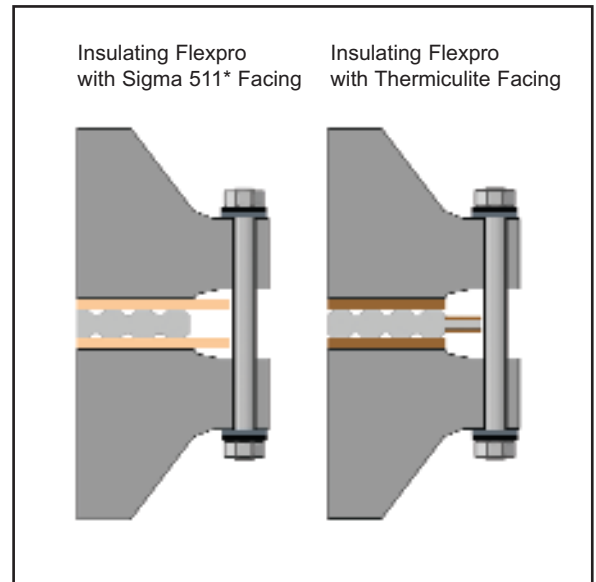

Metal Jacketed Gasket

Metal Jacketed Gaskets, as the name suggests, consist of a metallic outer shell with either a metallic or non-metallic compressed fiber filler. The filler material gives the gasket resilience, while the metal jacket protects the filler and resists pressures, temperatures and corrosion.

A wide range of materials are available to suit specific temperature and corrosive conditions.

<i>Metallic:</i>	Soft Iron	Inconel®	Aluminum	<i>Non-Metallic:</i>	Compressed Fiber Millboard
	Carbon Steel	Monel®	Brass		PTFE
	Stainless Steel	Nickel	Copper		Flexicarb®
			(Other materials on request)		Ceramic

Metal Jacketed Gaskets are available in a wide range of sizes and configurations. They are traditionally used for heat exchanger applications, pumps, and valves, however the resilience and recovery properties of these gaskets are limited. Metal Jacketed Gaskets require smooth flange surface finishes, high bolt loads, and flange flatness in order to seal effectively.

When pass partition bars are required, it is sufficient to use a gasket with a welded pass bar construction, as opposed to an integral pass bar construction. Jacketed gaskets standard tolerances:

<i>Jacketed Gaskets Standard Tolerances</i>		
<i>Gasket Outer Diameter</i>	<i>I.D.</i>	<i>O.D.</i>
Up to 6"	+1/32" / -0	+0 / -1/32"
6" to 60"	+1/16" / -0	+0 / -1/16"
Above 60"	+1/8" / -0	+0 / -1/8"

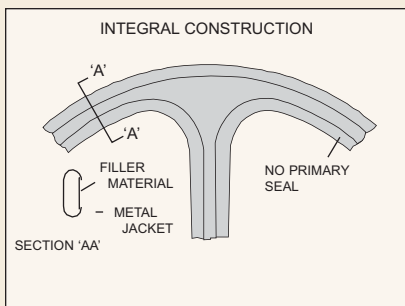

If leakage occurs across the pass partition bar, the fluid will flow along the length of the pass bar arrangements, and then flow to the outer diameter of the gasket being retained only by the secondary seal. The intermediate part of the gasket does very little to effect the sealing capabilities of the gasket.

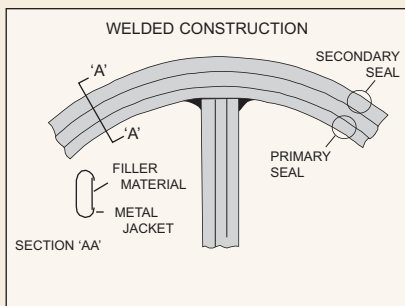

With a welded pass bar arrangement the fluid is retained by the primary seal at the inner diameter of the gasket. Thus the primary seal maintains its function, providing a seal of higher integrity.

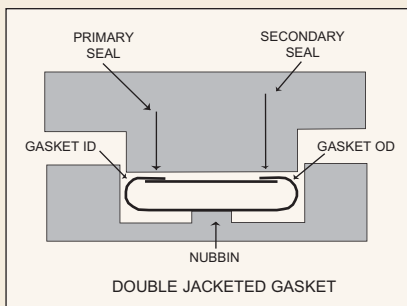

Due to the high bolt loads required to seat metal jacketed gaskets, designers often incorporate stress raising nubbins on the flange sealing face, the principle being that the majority of the applied bolt load is acting on a relatively small proportion of the gasket surface area, thus high surface stresses result. It is essential that the gasket is installed with the smooth side toward the nubbins.

Metal Jacketed Gasket

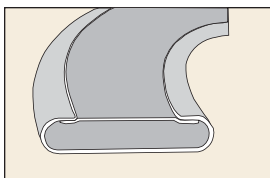

Style 123

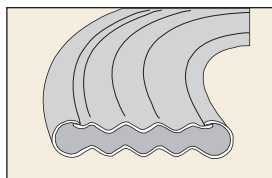

Style 126

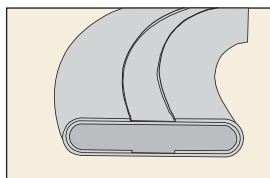

Style 127

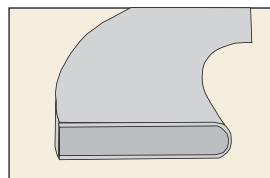

Style 130

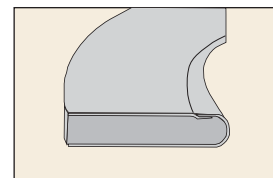

Style 131

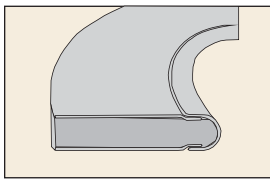

Style 132

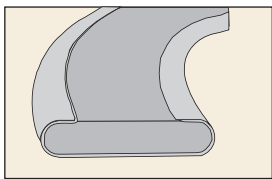

Style 120

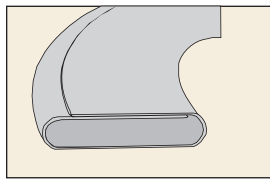

Style 124

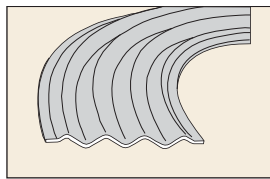

Style 100

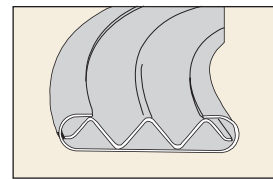

Style 102

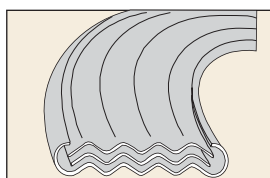

Style 129

DOUBLE JACKETED GASKETS (Styles 123, 126, 127)

The filler material is completely enclosed by a two piece metal jacket, which covers both the inside and outside diameters and both contact surfaces. Style 126 is similar to Style 123 with the exception that the metal jacket is formed from a corrugated jacket providing better resilience than the Style 123, since the corrugations form multi-seals across the flange sealing face. Style 127 is a double shell gasket constructed of two reversed wrap-around shells. This provides handleability and better resistance to high pressures.

Double Jacketed Gaskets are used in boiler and heat exchanger applications when ample bolting is available to correctly seat the gasket. They are designed for high pressure and temperature applications up to and inclusive of Class 900. The temperature limitation of the gasket is dictated by the combination of metallic and non-metallic materials used in its construction. Gasket widths as narrow as 5/16" (8mm) can be manufactured dependent on diameter. Very large gasket diameters can also be produced. Nominal gasket thickness is 1/8" (3.2mm). Gaskets can be manufactured with either integral or welded pass partition bars, in a variety of complex configurations. Some of the most common pass bar configurations are shown on page 25.

FRENCH-TYPE GASKETS (Styles 130, 131, 132)

The filler material is enclosed in a metal jacket, which covers the inside diameter of the gasket and completely covers the sealing faces on both sides. Available in three styles which are ideal for both small and large diameters in narrow as well as wide flange widths and in both circular and non-circular configurations. Typical applications include vacuum seals and valve bonnet seals of low pressure. Minimum gasket width 1/4" (6.4mm). Nominal gasket thickness 1/8" (3.2mm).

SINGLE JACKETED GASKETS (Styles 120, 124)









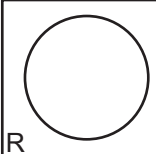
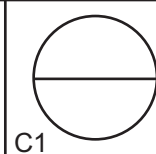
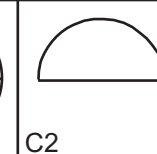
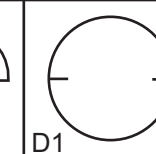

The filler material is enclosed in a metal jacket which covers the inside and outside diameter of the gasket. Style 120 has one of its contact surfaces covered and is ideally suited for comparatively narrow flange widths in circular and non-circular configurations. Style 124 is an overlapped Single Jacketed Gasket, where the filler is completely enclosed on the inside and outside diameters and on both contact surfaces. Style 124 is more suited for high temperature applications of narrow gasket widths. Typical low pressure applications include boilers, compressors, pumps, and diesel and gasoline engines. Style 120 is not recommended for standard pipe flanges. Minimum flange width 1/4" (6.4mm). Nominal gasket thickness 1/8" (3.2mm).

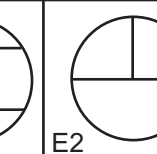
SOLID CORRUGATED METAL GASKETS (Styles 100, 102, 129)

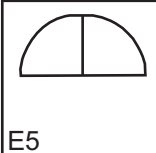
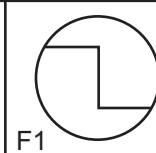
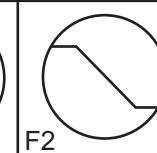
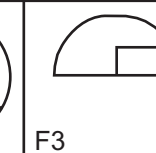
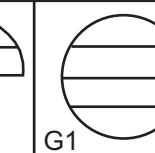
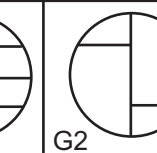
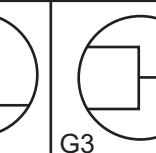
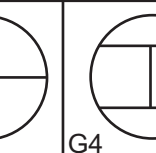
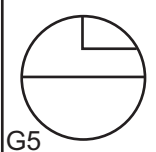
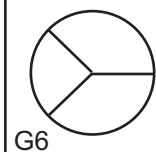
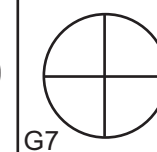
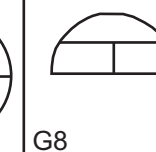
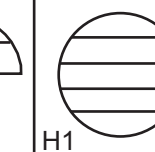
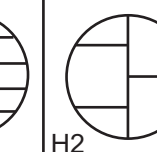
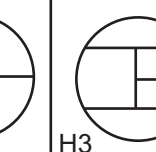
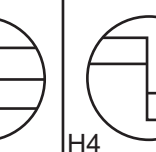
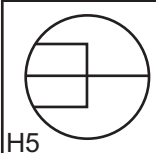
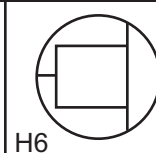
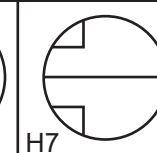
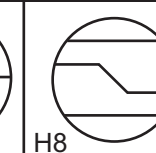
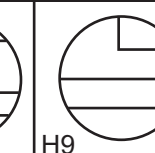
As the name suggests, the solid corrugated metal gasket is comprised solely of metal and does not contain any non-metallic fillers in its construction. The temperature limitation of the gasket is therefore only affected by the metal selected. The corrugations provide multi-seals across the face of the gasket. A minimum of three corrugations is recommended and gasket thickness is approximately 50% of the corrugation pitch. Pitch corrugations can be 1/8" (3.2mm), 3/16" (4.8mm) or 1/4" (6.4mm). Typically used for high temperature applications and applications involving steam, water, gas, oil, etc. up to 1000 psi for Style 129 and 102, and up to 500 psi for Style 100. Style 100 is also available with soft conformable facings such as graphite, PTFE and others.

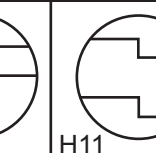
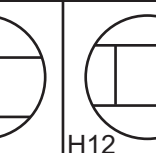
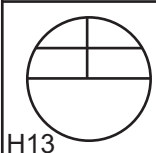
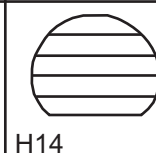
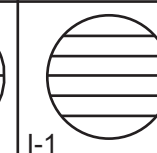
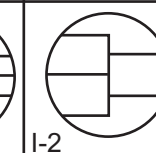
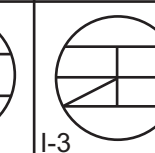
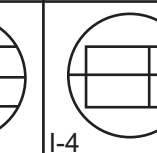
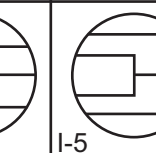
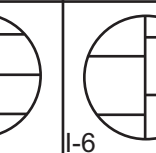
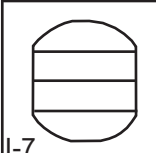
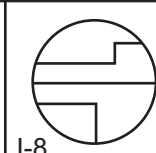
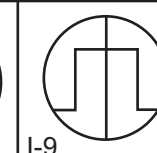
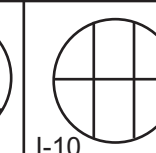
Heat Exchanger Gaskets

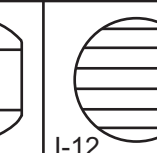
Schedule of Standard Shapes for Heat Exchanger Gaskets

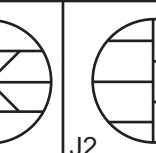
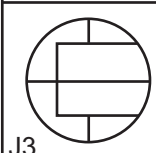
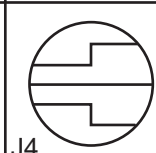
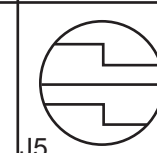
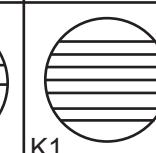
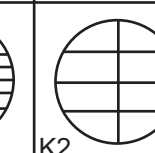
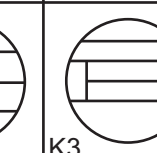
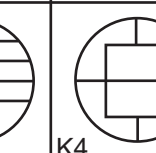
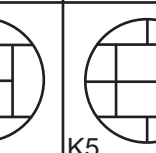
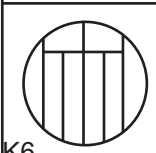
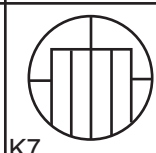
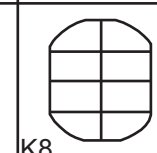
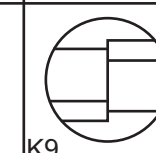
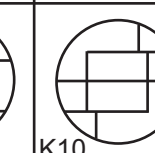
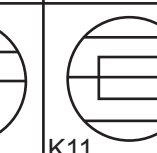
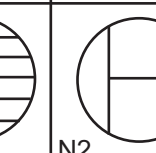
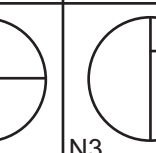
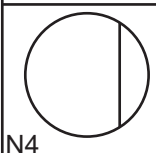
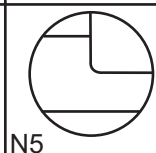
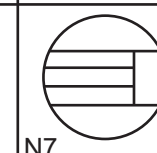
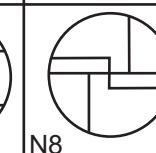
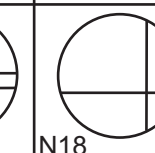
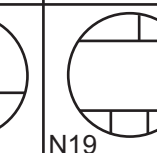
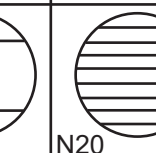
 R	 C1	 C2	 D1	 E1	 E2	 E3	 E4
 E5	 F1	 F2	 F3	 G1	 G2	 G3	 G4
 G5	 G6	 G7	 G8	 H1	 H2	 H3	 H4
 H5	 H6	 H7	 H8	 H9	 H10	 H11	 H12
 H13	 H14	 I-1	 I-2	 I-3	 I-4	 I-5	 I-6
 I-7	 I-8	 I-9	 I-10	 I-11	 I-12	 J1	 J2
 J3	 J4	 J5	 K1	 K2	 K3	 K4	 K5
 K6	 K7	 K8	 K9	 K10	 K11	 N2	 N3
 N4	 N5	 N7	 N8	 N18	 N19	 N20	

Other bar configurations available on request.

Spiral Wound Gasket

A requirement of any gasket is the ability to recover under variable loads. The effects of pressure and temperature fluctuations, the temperature difference across the flange face, along with flange rotation, bolt stress relaxation and creep, demand a gasket with adequate flexibility and recovery, to maintain a seal under variable working conditions. The spiral wound gasket, invented by Flexitallic, meets these requirements.

A spiral wound gasket is manufactured by spirally winding a preformed metal strip and a filler on the outer periphery of metal winding mandrels. The winding mandrel outside diameter forms the inner diameter of the gasket and the superposed metal and non-metallic windings are continually wound until the required outer diameter is attained. Normal practice is to reinforce the inner and outer diameters with several plies of metal without fillers. This engineered product is "tailor made" to be compatible with the flange closure in which it is to be used. For example, a closure designed for vacuum service may require a gasket of exactly the same dimensions as a closure designed for 1500 psi service. The closure designed for the vacuum service would have relatively light bolting indicating the necessity for a soft gasket, while the 1500 psi application would have heavy bolting requiring a relatively dense gasket. It is usually within our capability to satisfy both requirements.

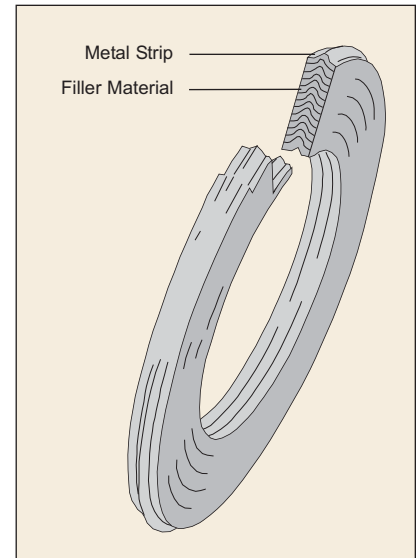
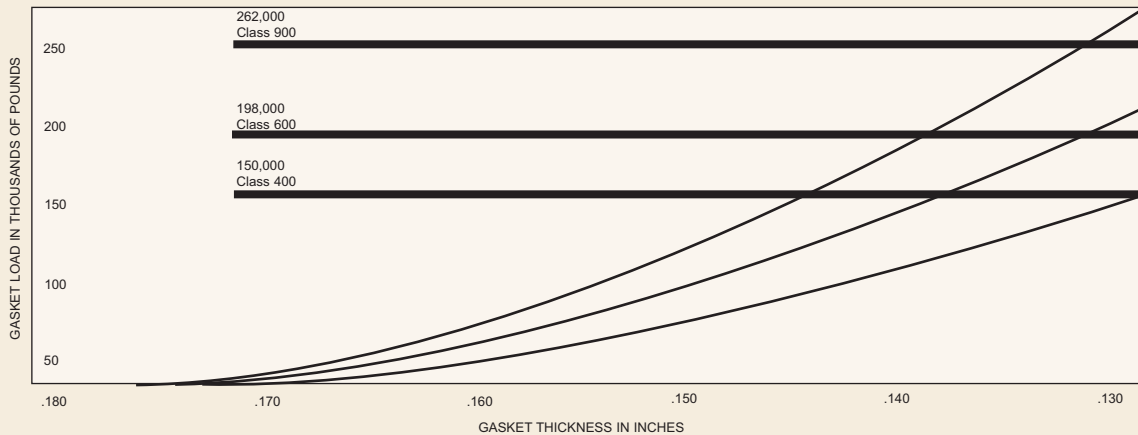

CHART NO. 1 GASKET COMPRESSION CHARACTERISTICS

6" Style CG Gasket
Contact Area: 14.7 Square Inches
Original Gasket Thickness 0.175"

This chart shows compression to 0.130" under stud stress of 30,000 psi of root area



GASKET DENSITY

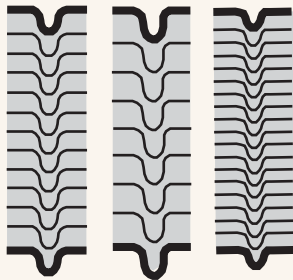

The service conditions under which a FLEXITALLIC spiral wound gasket is expected to hold its seal dictate the density of the gasket. Gaskets that have identical inside and outside diameters can be either hard or soft as shown on the left. The available compressive force is the basis for calculating the density of the gasket structure to support specific loads.

Spiral Wound Gasket

STYLE CG

Utilizes an external ring which accurately centers gasket on flange face; provides additional radial strength to prevent gasket blowout and acts as a compression stop. A general purpose gasket suitable for use with flat face and raised face flanges. Where space is limited it may be possible to provide a spiral wound outer ring for proper centering; consult Flexitallic Engineering.

STYLE CGI

Incorporates an inner ring to the Style CG which provides an additional compression stop and additional blowout resistance, prevents build-up of process fluid, minimizes erosion and turbulence, shields the gasket, and prevents inward buckling of the gasket. Suitable for use with flat face and raised face flanges and specified for high pressure/temperature service or where corrosive or toxic media are present.

Note on use of inner rings: ASME B16.20, which covers spiral wound gaskets, requires the use of solid metal inner rings in:

- Pressure Class 900, nominal pipe sizes 24" and larger
- Pressure Class 1500, nominal pipe sizes 12" and larger
- Pressure Class 2500, nominal pipe sizes 4" and larger
- All PTFE filled gaskets
- Inner rings for flexible graphite filled spiral wound gaskets shall be furnished unless the purchaser specifies otherwise.

Flexitallic also recommends the use of inner rings for the following applications:

- Vacuum service or suction side of rotary equipment such as pumps and compressors
- Aggressive media, high pressure or temperature
- Surface finishes smoother than 125 Ra
- If over compression of the gasket is a concern.

It is customary to select inner ring material to be the same as the metal winding.

STYLE R

Basic construction, inner and outer diameters are reinforced with several plies of metal without filler to give greater stability and better compression characteristics. Suitable for tongue and groove or male and female or groove to flat face flange assemblies.

STYLE RIR

Solid inner metal ring acts as a compression stop and fills the annular space between flange bore and the inside diameter of the gasket. Designed to prevent accumulation of solids, reduce turbulent flow of process fluids and minimize erosion of flange faces. Suitable for male and female pipe flanges.

MULTI-CLASS

One gasket accommodates both Class 150 and 300 flanges. Multi-Class Gasket features are as follows:

- One gasket accommodates both Class 150 and 300 flanges, available pipe size 1/2" - 24" (Class 150 to 600 in NPS 1/2 through NPS 3)
- Available in LS style
- Reduces inventory requirements
- Easy to install . . . Less than half the studs need to be removed to change the gasket.

STYLE HE

Style HE gaskets are used for heat exchangers where pass bars may be required. The outer portion is of standard spiral wound construction, whereas the pass bar is normally of single or double jacketed style, securely fastened to the I.D. of the spiral wound portion.

Style CG

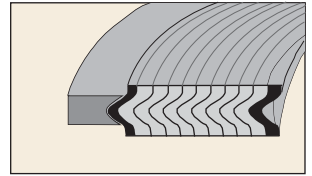

Style CGI

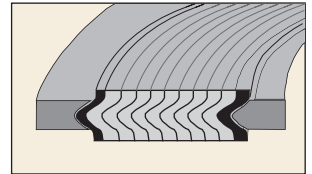

Style R

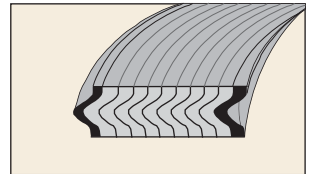

Style RIR

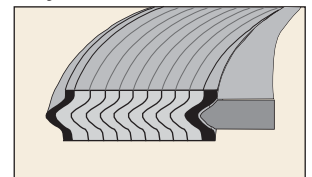

Multi-Class

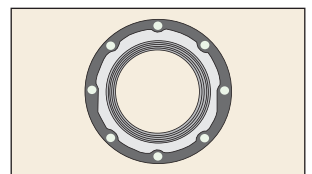

Style HE

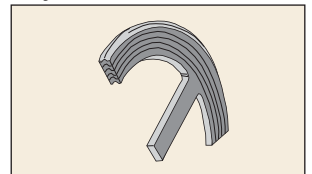

Spiral Wound Gasket

STYLE HE-CG

This style is identical to the Style HE, except that it is fitted with an outer guide ring. Note: Style HE and Style HE-CG gaskets have a primary seal of spiral wound construction with its inherent resiliency and excellent sealing quality. It is necessary that dimensional drawings locating the pass bar and the configurations be submitted for all inquiries and orders for these style gaskets.

STYLE HE-CGI WITH SPIRAL WOUND OUTER RING

The Style HE-CGI is a variation of the style CGI spiral wound gasket, developed for use on heat exchanger, TEMA type flange arrangements. In conjunction with an inner ring, the standard spiral wound construction also supports an outer wound steel nose, designed for the purpose of accurate gasket location. It is also available with a solid metal outer ring. Consult Flexitallic Technical Department for minimum cross sectional width of solid metal outer ring.

STYLE CG-RJ, CGI-RJ

Specially sized CG or CGI gasket to be used on standard ring joint flanges. The outer ring is dimensioned to cover the ring joint grooves and to prevent the spiral wound portion from entering the groove. Also, suitable for use between an RTJ and a raised face flange. Available in special ZA Flexpro style.

CARRIER RING

The carrier ring gasket consists of two spiral wound gaskets placed in a specially machined metallic ring as illustrated. The major advantages of the carrier ring are its high recovery, and ease of handling compared to standard spirals, due to its integral construction.

STYLE 625

Style 625 spiral wound gaskets are similar to Style R gaskets, with a thickness of 0.0625". These gaskets are widely used wherever space restrictions indicate the need for a wafer thin gasket design capable of sealing high pressures. Limited sizes, refer to page 34.

STYLE T

These gaskets are used for boiler handhole and tube cap assemblies. They are available in round, oval, obround, square, pear and diamond shapes. Refer to our general catalogue for standard Style T gaskets. Please note Style T gaskets rely on internal pressure in the boiler to properly seat the gasket. This means, when a hydrostatic test is performed on the gasket, the pressure exerted against the plate will further compress the gasket - and it is necessary to tighten each nut to compensate for the additional compression of the gasket under load.

STYLE M, MC & MCS

These styles are designed for boiler manhole cover assemblies. They are usually of round, obround or oval shape, depending of course, upon the manhole plate configuration. Style MC gaskets have pre-formed inner and/or outer rings made of spiral windings. This centering guide permits the gasket to assume its correct position and to compensate for inequalities in plate contours and fillets in cold-pressed plates as well as to prevent shouldering and pinching caused by radial misplacement. Style MCS gaskets are manufactured with a solid metal inner ring which also prevents over compression of the gasket in high pressure systems. Oval and obround man-way gaskets can be made with the Flexpro technology in one continuous piece.

Style HE-CG

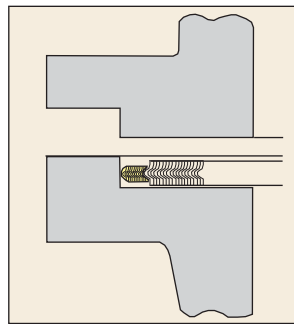

Style HE-CGI

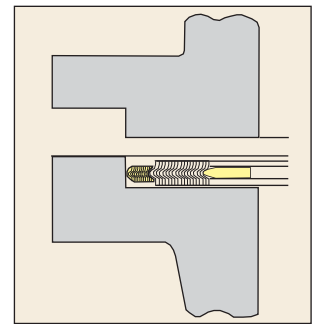

Style CG-RJ

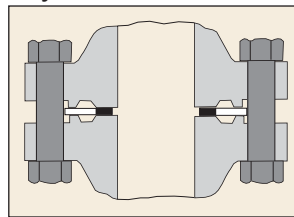

Carrier Ring

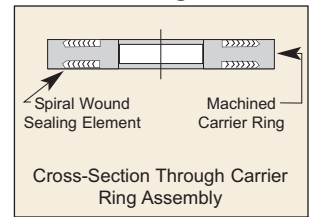

Style 625

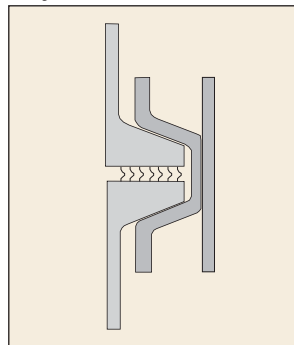

Style T

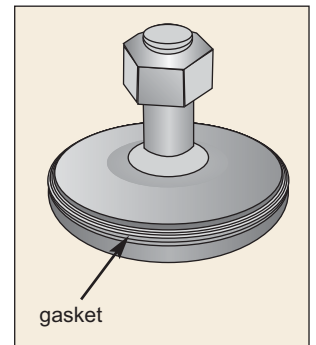

Style MC

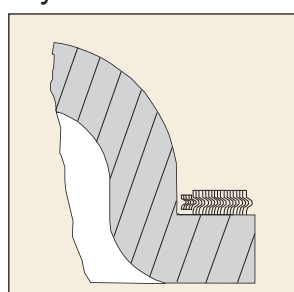

Style M

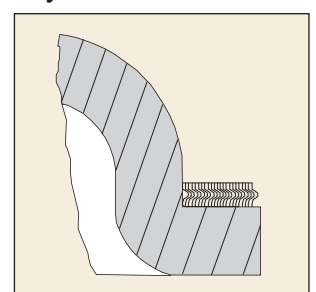

Style MCS

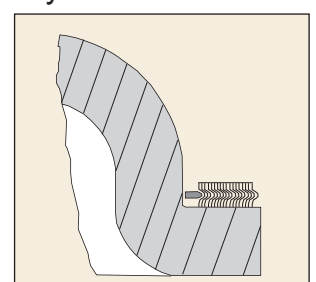

Low Stress Spiral Wound Gasket Style LS® & LSI®

The Style LS spiral wound gasket has been engineered by FLEXITALLIC to provide an alternative to sheet gaskets in Class 150 and Class 300 service. Style LS gaskets have the inherent strength, resiliency and blowout resistance of spiral wound gaskets, yet require low bolt load for seating. They are manufactured with high purity flexible graphite, and PTFE filler for optimum sealability, and are available for the full range of standard Class 150 and Class 300 flanges, as well as other non-standard low pressure flanges. Consult Flexitallic Technical Department for availability of other filler materials. PATENT NUMBERS 5161807 and 5275423.

The gasket allows designers to strictly adhere to ASME BPV and ASME B31.3 codes requiring that bolt stresses do not exceed 25,000 psi. Where ASME flange design calculations indicate that flanges will be over stressed if a standard Class 150 spiral wound gasket is used, the LS gasket is designed to compress at significantly lower bolt load than standard Class 150 spiral wound gaskets, thereby maintaining flange stresses within allowable limits.

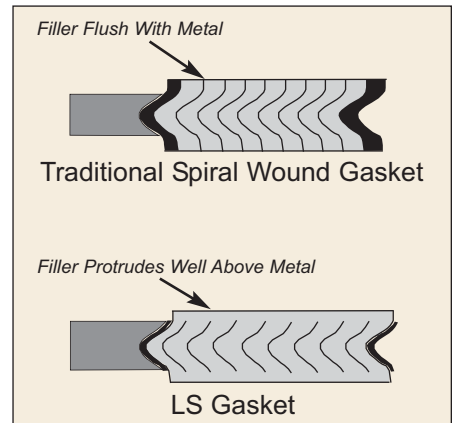

Style LS

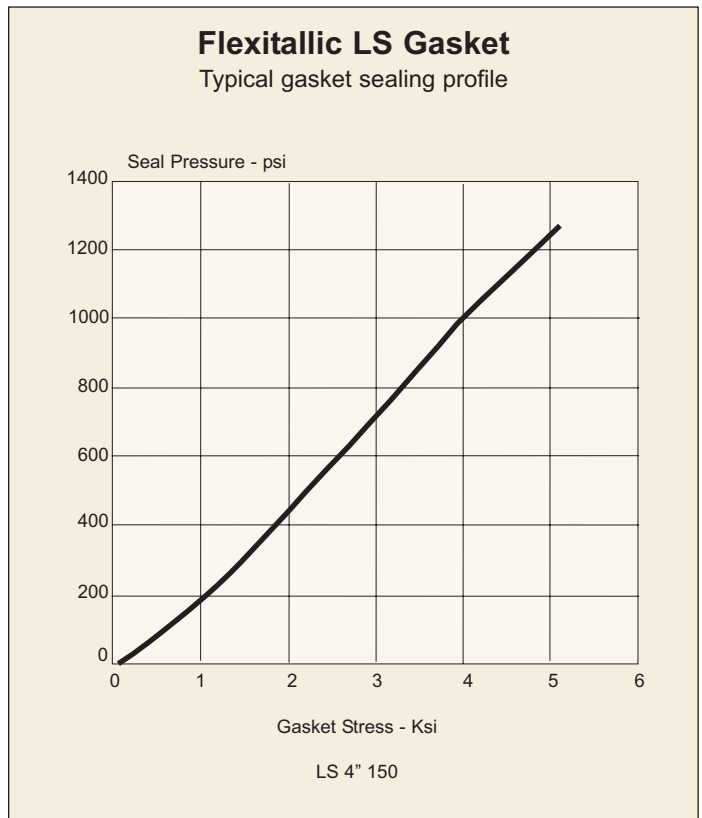
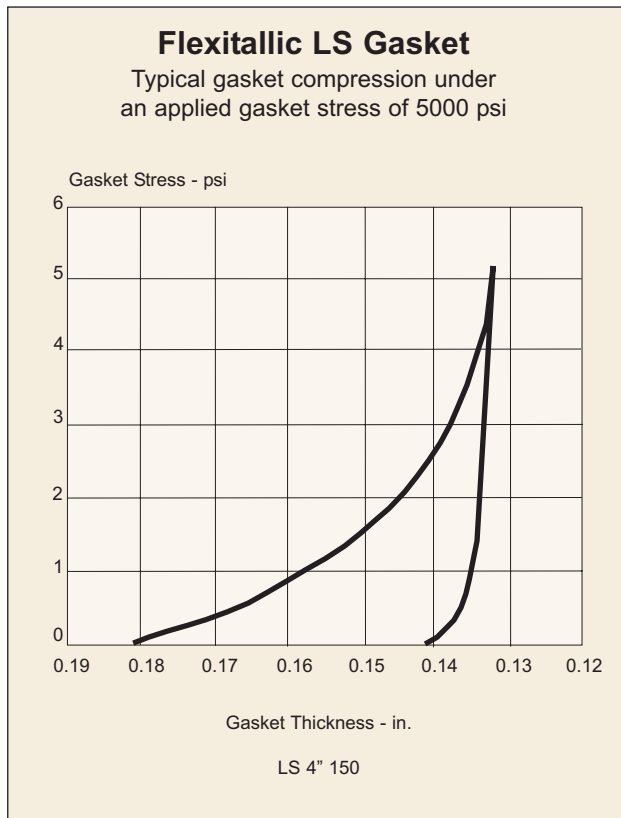

Spiral Wound Gasket with Heat Treated Inconel X-750 Winding

For the most demanding cyclic conditions, the choice is Flexitallic's Thermiculite® 835 Spiral Wound Gasket with Heat Treated Inconel X-750 winding.

Differential thermal expansion and contraction of components in a bolted joint, due to the effects of cyclic conditions, requires that extra resiliency be built into the joint or the gasket to compensate for fluctuating load conditions.

Normal gasket materials do not provide sufficient resiliency, and therefore cannot compensate for the adverse effects of cyclic conditions. Special Heat Treated Inconel X-750 gasket materials have been developed by Flexitallic to ensure that joint integrity is maintained during thermal cycles.



In OEM and End User testing comparing the performance of standard 316L SS windings vs. Heat Treated Inconel X-750 windings (precipitation hardened), HT Inconel X-750 winding material significantly increased the yield strength resulting in increased springback before leakage, or usable recovery.

Specify Flexitallic's proprietary precipitation hardened Inconel X-750 windings in applications where there are concerns about:

- Cyclic conditions
- Differential thermal expansion and contraction
- Radial shear
- Bolt relaxation
- Hot torquing
- Mating flanges of dissimilar metals

When ordering this material it is important that you specify PRECIPITATION HARDENED INCONEL X750 WINDINGS, OR INCONEL X750HT.

Full Scale Test Results (averaged) Gasket Dimensions 40-5/8" x 42" x .175"		
Winding Material	316L SS	Heat Treated Inconel X-750
Initial Thickness	0.178"	0.179"
Compressed Thickness	0.122"	0.121"
Total Springback	0.011"	0.013"
Springback to Leakage @ 2500 psi Test Pressure	0.0038"	0.0078"



Ethylene Cracker Unit

Case History - Ethylene Cracker

- 1300°F Service
- Flexible graphite gaskets lasted only 3 to 6 months
- Hydrocarbon leaks resulted in flash fires and unplanned shutdowns
- Style CGI spirals, Heat Treated Inconel X-750 with Thermiculite® 835 filler extended service beyond 1-1/2 years until scheduled shutdown

Net result was increased production and elimination of safety related issues, resulting in savings "in the millions".

Be sure to specify Heat Treated Inconel X-750 windings for superior resiliency.

Spiral Wound Gasket

Gaskets are color coded to help expedite the selection and identity of the gaskets you need. The color on the outside edge of the centering ring identifies both the winding and filler materials. The metallic winding material is designated by a solid color. The filler materials are designated by color stripes at equal intervals on the outside edge of the centering ring. Flexitallic color coding meets the industry standard for metal and filler materials listed in ASME B16.20.

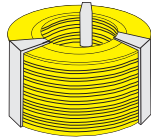
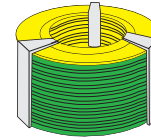
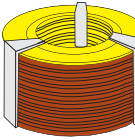
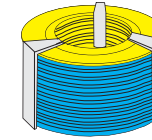
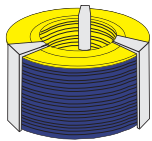
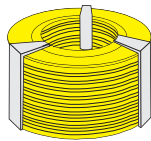
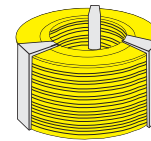
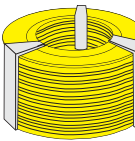
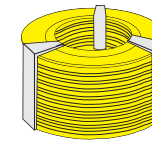
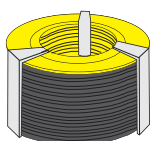
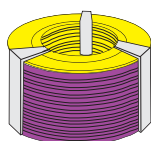
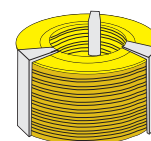
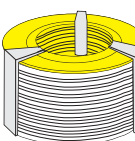
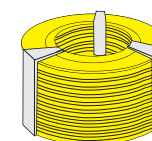
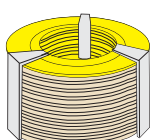
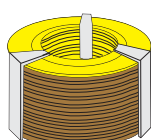
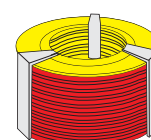
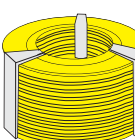
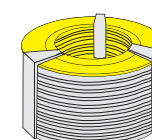
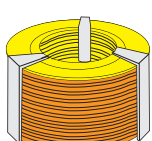
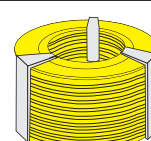
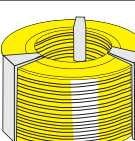
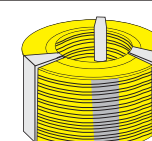
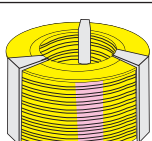
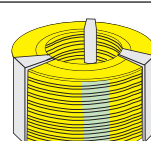
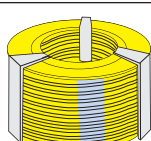
<p>METALLIC WINDING MATERIALS The metallic winding material is designated by a solid color identification around the outside edge of the centering ring.</p>	 304SS Yellow	 316LSS Green	 317L Maroon	 321SS Turquoise
 347SS Blue	 310SS No color	 304LSS No color	 309SS No color	 430SS No color
 Alloy 20 Black	 Titanium® Purple	 Inconel® 600/625 Gold	 Incoloy® 800/825 White	 Inconel® X750 No Color
 Hastelloy® C276 Beige	 Hastelloy® B2 Brown	 Nickel 200 Red	 Zirconium No color	 Carbon Steel Silver
 Monel® Orange	 Duplex No color	<p>NON METALLIC FILLERS The gasket filler materials are designated by a number of stripes placed at equal intervals around the outside edge of the centering ring.</p>	 PTFE White Stripe	 Flexicarb® Gray Stripe
 Flexite Super® Pink Stripe	 Ceramic Light Green Stripe	 Thermiculite® 835 Light Blue Stripe		

Spiral Wound Gasket

FILLER MATERIALS

THERMICULITE® 835

Exclusive to Flexitallic, this revolutionary material comprised of chemically and thermally exfoliated vermiculite makes it an excellent filler material for use in spiral wound gaskets.

This naturally occurring mineral, with a plate-like structure, simulates that of exfoliated graphite, with one notable exception – it is not susceptible to oxidation and therefore maintains seal integrity through a wide range of extreme temperatures. It exhibits exceptional chemical resistance.

Spiral Wound Filler Guide	Filler Type				
	Thermiculite® 835	Flexicarb ¹	PTFE ²	Flexite Super ³	Ceramic
Maximum Temperature	1800°F 982°C	842°F 450°C	500°F 260°C	480°F 249°C	2300°F 1260°C
Minimum Temperature	-400°F -240°C	-400°F -240°C	-400°F -240°C	-150°F -101°C	-150°F -101°C

Capable of sealing temperatures up to 1800°F (982°C), Thermiculite® 835 is an ideal material selection for critical and problematic applications. It is versatile, fire safe and its excellent sealing characteristics are superior to other high temperature materials such as mica and ceramic. Thermiculite® 835 is especially suitable for high temperature applications where there is a concern about oxidation of flexible graphite filler.

FLEXICARB®

A high purity flexible graphite with no binders or fillers. It exhibits superior sealability, and excellent resistance to a wide range of chemicals. Its unique combination of low permeability, inherent lubricity, and compressibility make FLEXICARB suitable for critical gas and vacuum service. Leachable chloride content of industrial grade FLEXICARB is 50 ppm maximum. Available in industrial, nuclear or corrosion inhibited grades.

POLYTETRAFLUOROETHYLENE (PTFE)

PTFE is used as a filler material in Flexitallic gaskets where extreme chemical inertness is required. PTFE is unaffected by any known chemicals except molten alkali metals and fluorine precursors. Because of its low permeability, PTFE is also frequently used as a filler material on FLEXITALLIC gaskets in vacuum applications. Gaskets wound with PTFE should be fully confined either by fitting in a groove or providing both an external and internal ring.

FLEXITE® SUPER

Low chloride filler material, developed by FLEXITALLIC, consisting of a Chlorite mineral with graphite and acrylic binder. This material may be used for general service applications.

CERAMIC FIBER

Consists of aluminum silicate fiber with an organic binder. This material possesses a lower sealability compared to other filler materials, however, it has excellent high temperature stability to 2300°F (1250°C). It resists attack from most corrosive agents (except hydrofluoric and phosphoric acids) as well as concentrated alkalis. Recommended only where conditions preclude the use of Thermiculite® filler.

¹ Although Flexicarb has successfully been used at elevated temperatures we recommend that you consult our engineering department for specific applications.

² Several types of PTFE are available. Please consult Flexitallic Engineering department.

³ Although Flexite Super has successfully been used at elevated temperatures we recommend that you consult our engineering department for specific applications.

Spiral Wound Gasket

Manufacturing Capabilities and Tolerances

Recommended Design Parameters			
Gasket Thickness	Maximum Inside Dimension	Maximum Recommended Cross-sectional Width	Recommended Compressed Thickness **
0.0625"	Up to 6"	3/8"	0.050" / 0.055"
0.0625"	6" to 15"	1/4"	0.050" / 0.055"
0.100"	10"	1/2"	0.075" / 0.080"
0.125"	Up to 20"	1"	0.090" / 0.100"
0.125" *	20" to 40"	3/4"	0.090" / 0.100"
0.175"	Up to 40"	1"	0.125" / 0.135"
0.175" *	40" to 60"	1"	0.125" / 0.135"
0.175" *	60" to 70"	7/8"	0.125" / 0.135"
0.175" *	70" to 75"	3/4"	0.125" / 0.135"
0.250"	90"	1"	0.180" / 0.200"
0.285"	185"	1"	0.200" / 0.220"

Preferred size range in relation to thickness shown in bold type.

* PTFE filled FLEXITALLIC gaskets in this size range are unstable and are subject to "springing apart" in shipping and handling. Specify next gasket thickness up.

** The recommended compressed thickness is what experience has indicated to be the optimum range in order to achieve maximum resiliency of the gasket. Additional compression of 0.010" may be tolerated on all gasket thicknesses with the exception of the 0.0625" and the 0.100" thick gaskets. This is on the assumption that the flange surface finishes are relatively smooth. Refer to "Surface Finish Requirements" on page 51. When attempting to contain hard to hold fluids, or pressures above 1000 psi, it is suggested that compression be maintained at the lower range of the recommended compressed thickness.

Standard Tolerances		
Gasket Diameter	Inside Diameter	Outside Diameter
Up to 10"	± 1/64"	± 1/32"
10" to 24"	± 1/32"	± 1/16"
24" to 60"	± 3/64"	± 1/16"
60" & Above	± 1/16"	± 1/16"

Tolerance on gasket thickness is ± 0.005", (measured across metal winding) on all thicknesses.

Sizing of Spiral Wound Gaskets

Of utmost importance, regardless of the type of flange facings in use, Flexitallic gaskets must be sized to ensure that the sealing element is seated against flat surfaces. If the spiral wound element intrudes into the flange bore, or extends beyond the raised face outside diameter damage will result to the gasket, and ultimately failure will occur.

The windings of the gasket can become unwound when the gasket intrudes into the flange bore. Possible severe damage to components and equipment can occur when the system is pressurized.

The gasket will grow radially during the compression phase and it is essential that proper clearances are used for grooves and recesses to compensate for this.

The following general rules apply for sizing of spiral wound gaskets:

Gaskets confined on both I.D. and O.D.

These types of flange facings are tongue and groove and groove to flat face flanges. Standard practice is to allow 0.062" (1.5mm) nominal diametrical clearance between the inside diameter of the groove and the inside diameter of the gasket. A nominal diametrical clearance of 0.062" (1.5mm) between the gasket outside diameter and the outside diameter of the groove is recommended.* It is also recommended that when using standard tongue and groove flanges a compression stop is provided to prevent any over-compression of the gasket.

Gasket confined on the O.D. only

These types of flange facings are known as male to female and female to flat flanges. Standard practice is to allow 0.062" (1.5mm) nominal diametrical clearance between the outside diameter of the gasket and the outside diameter of the groove.* Whenever possible allow a minimum of 0.25" (6.35mm) diametrical clearance between the bore of the flange and the inside diameter of the gasket.

Gasket unconfined on both the I.D. and O.D.

Allow a minimum 0.25" (6.35mm) diametrical clearance between the gasket inside diameter and the inside diameter of gasket seating surface.

The outside diameter of the sealing element should be kept as close as possible to the bolt circle to minimize the effects of flange bending moments.

If the gasket is used on raised face flanges, allow a minimum 0.25" (6.35mm) diametrical clearance between the gasket outside diameter and the raised face outside diameter and determine the gasket inside diameter on the basis of the desired gasket cross sectional width.

Note: The above rules are established general limits for sizing of Flexitallic spiral wound gaskets. It is frequently necessary to adjust dimensions to achieve a proper balance between gasket area and available bolt area in order to maintain a reasonable compressive force on the gasket and the minimum gasket factor "y". Refer to the section covering ASME Boiler and Pressure Vessel Code on page 44.

Metal Guide Rings

When Flexitallic gaskets are required to be equipped with inner and/or outer metal rings, limitations on the minimum widths of the rings are necessary due to machining limitations and rigidity of the complete assembly. Standard practice is to size outer rings with the outside diameter equal to the diameter of the bolt circle less the diameter of one bolt for rings up to 60" O.D. Above 60" O.D. rings are sized to the diameter of the bolt circle less the diameter of one bolt hole. The table below indicates the minimum width for solid metal rings based on the ring I.D.

*Note: 1/16" nominal O.D. clearance for gaskets up to 60" O.D.; from 60" O.D. to 80" O.D., allow 5/64"; above 80" O.D allow 3/32" nominal O.D. clearance.

**Note: Where space is limited and narrower ring widths are necessary, it may be possible to supply inner and outer spacer rings of metal spiral wound construction. Consult FLEXITAL-LIC Technical Department for advice.

Diameter of Ring	Minimum Width**	
	Outer Ring	Inner Ring
Up to 10" Inside Diameter	3/8"	1/4"
10" to 24" Inside Diameter	7/16"	3/8"
24" to 50" Inside Diameter	1/2"	3/8"
50" to 70" Inside Diameter	5/8"	1/2"
70" and Larger	3/4"	1/2"

Sizing of Spiral Wound Gaskets

Non-circular Spiral Wound Gaskets

Spiral wound gaskets can be fabricated in non-circular shapes within limitations. As a general rule, if the ratio of the major I.D. to the minor I.D. exceeds 3 to 1, and should any of these sides approach a straight line, it may not be possible to manufacture a stable spiral wound gasket. Our product requires a definite radius or curvature to give it inherent strength and stability and to prevent it from springing apart. Any application requiring a non-circular gasket should be submitted to our Technical Department for review to determine the feasibility of producing a satisfactory gasket as early as possible in the design stage.

The comments above and on the previous page relating to availability of sizes and recommended clearances for proper sizing of FLEXITALLIC gaskets are general in nature. Many applications will arise where the recommended clearances are impractical due to space limitations. Frequently, clearances between gasket sealing member and grooves must be reduced in order to effectively maintain a seal under operating conditions, particularly when higher pressures are encountered. Under such circumstances, FLEXITALLIC engineers should be consulted prior to finalizing designs.

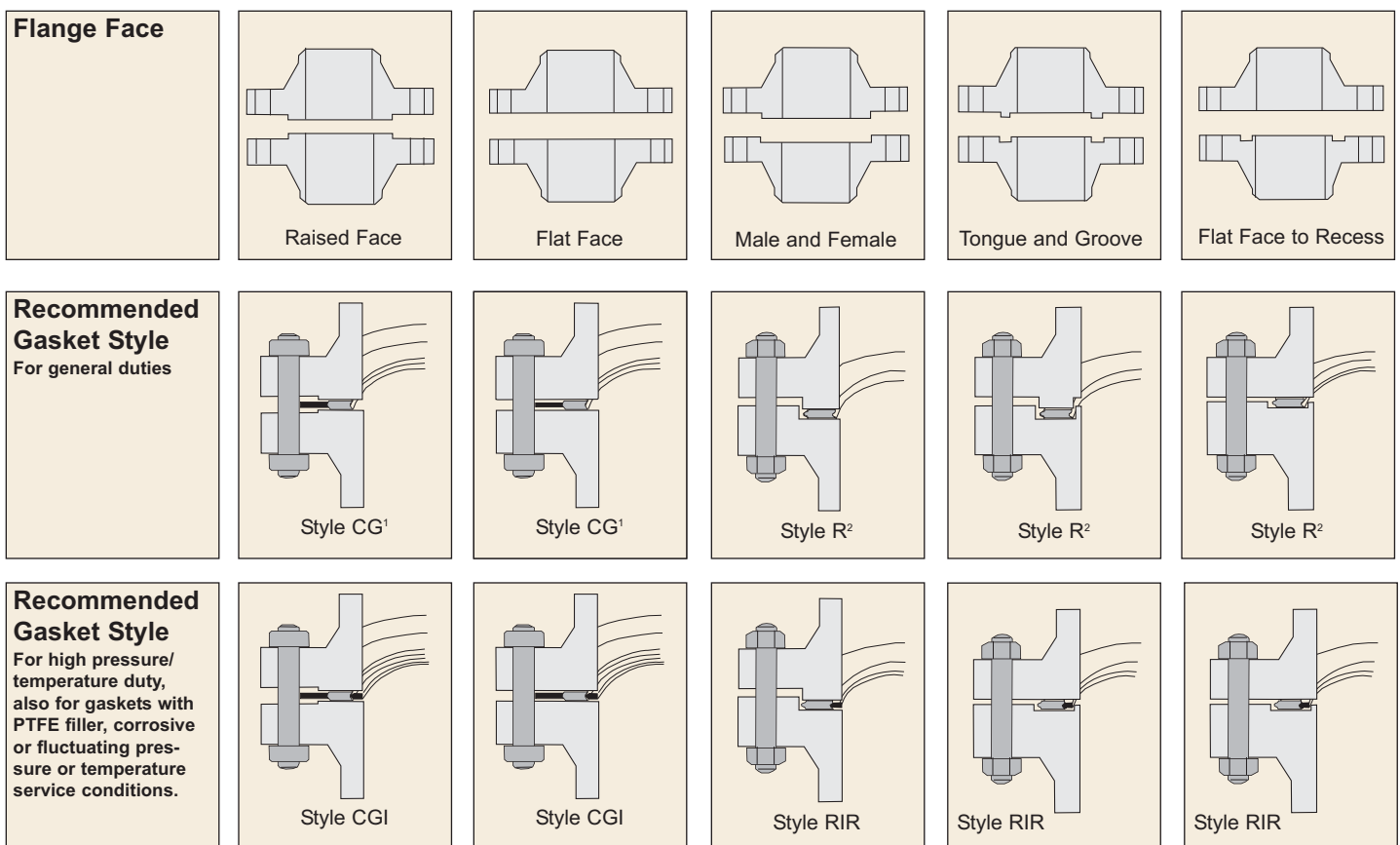

¹Per ASME B16.20. Style CGI shall be furnished for graphite filled spiral wounds unless the purchases specifies otherwise.

²It is essential that Style R gaskets are fitted with a compression stop. Without a correctly dimensioned stop the gasket can easily be over-compressed resulting in failure. To provide a compression stop the depth of the tongue, groove or recess should be controlled to provide optimum compressed gasket thickness with metal to metal contact on the flange faces (see table on Page 33).

Flexpro™ Gasket

The Flexpro, also known as the kammprofile gasket, offers a safe and effective seal under the most severe operating conditions for use in both standard pipe and equipment flanges. Flexpro gaskets are suitable for use in Class 150 to 2500 service. They are frequently selected as a favorable replacement for jacketed gaskets commonly used on heat exchangers. The Flexpro gasket features excellent tightness providing high seal integrity and reduced emissions.

The Flexpro gasket consists of a solid grooved metal core with soft conformable facing materials bonded on both sealing surface faces. The precise concentric machined grooves enhance sealing performance by means of inducing high stress concentrations across the peaks of the grooves during the seating of the gasket. Due to the precise machining of the grooves consistent and repeatable gasket stresses are achieved. It is robust, blow out resistant, and does not require a compression stop to prevent over-compression. The soft conformable facings require initial low stress for gasket seating, and the facing material is trapped within the grooves minimizing flow or extrusion.

Graphite is offered as the standard sealing face material and the metal core is grade 316L stainless steel. Other soft conformable facings offered are Thermiculite®, PTFE, Sigma®, compressed fiber, and soft metals.

Selection of facing and metal core material is dependent on application and design conditions, such as chemical compatibility and/or temperature.

The Flexpro gaskets are manufactured with two types of core profiles: DIN and the more commonly used “shallow profile”.

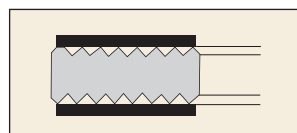
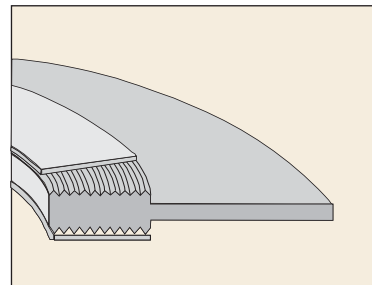

Style PN

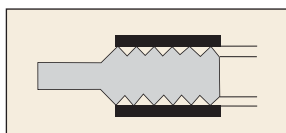

Style ZG

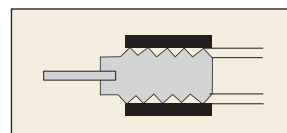

Style ZA

Style PN Flexpro gaskets are selected for use in confined locations, including male and female, tongue and groove, and recessed flange arrangements.

Variation of the PN Flexpro, utilizing an integral outer locating ring for correct gasket positioning within the mating flange bolt circle. Style ZG Flexpro gaskets are recommended for use on standard raised face and flat face flange assemblies.

The Style ZA Flexpro is a slight variation of the Style ZG. The integral outer locating ring is replaced by a loose fitting independent ring which is preferred where flange differential radial thermal expansion may be encountered. These rings may also be spot welded.

Flexpro Gasket Materials			
Metallic Core Materials			Soft Facing Materials
Type 316L SS	Carbon Steel	Hastelloy C276	Flexicarb Thermiculite® 845 Compressed Fiber PTFE* Sigma® Soft Metals
Type 304 SS	Monel	Aluminum	
Type 309 SS	Inconel 600	Copper	
Type 310 SS	Inconel 625	Brass	
Type 317L SS	Inconel X-750	Nickel 200	
Type 321 SS	Incoloy 800	Alloy 20	
Type 347 SS	Incoloy 825	Duplex	
Type 430 SS	Hastelloy B2	Titanium	

* Available in several types of soft facing PTFE. Consult Flexitallic Technical Department.

Note: Using our state of the art manufacturing equipment, Flexpro gaskets can be manufactured in a wide range of shapes in addition to round, e.g. square, rectangular, triangular, and other non-standard shapes

Metal Reinforced Gasket (MRG)

An MRG (Metal Reinforced Gasket) is a laminated gasket consisting of a metal core, covered with soft conformable sealing materials on each face of the core.

While the solid metal core prevents gasket blowout, it provides high strength and rigidity; and the soft facings provide for an exceptional seal.

The metal core material is selected to suit the media to be sealed. A wide range of core materials is available. For chemical resistance and temperature stability purposes, the correct core material must always be selected.

Standard core material is either 304 or 316L stainless steel, and standard core thickness is 1/8".

The soft gasket facings can be Flexicarb, PTFE, Sigma®, Thermiculite®, or compressed fiber gasket material. However, Flexicarb is the standard and most widely used facing material supplied with the MRG gasket.

Suitable up to pressure Class 300, the MRG is widely used in the chemical and petrochemical industries, where a high temperature, corrosion resistant, high integrity joint is required. Although the MRG gasket can be utilized on standard flange applications in place of conventional compressed fiber sheet gaskets, or in some instances spiral wound gaskets, it is on special type assemblies where the MRG is mainly utilized. Due to laser manufacturing techniques, any type of gasket shape can be produced.

Where restricted or limited space precludes the use of spiral wound gaskets or limited bolt load is available to seat the gasket, the MRG's narrow cross sectional width makes it ideal for use in floating head arrangements of heat exchangers.

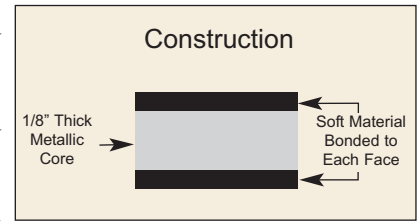

Corrosion Prevention & Resistance (CPR)

For Asset Managers and Engineers in the oil and gas industries, the fight against corrosion is a constant battle. Internal corrosion of flanges are responsible for a significant number of hydrocarbon and corrosive chemical releases and can have a major impact on operation costs, particularly on older assets.

The CPR has been created in direct response to this problem. Utilizing Flexitallic's Flexpro sealing element and 1/4" Sigma® 600 inner ring, the CPR is capable of adapting to extensively damaged flange sealing surfaces. Full closure of the corroded area prevents further damage, and for the first time, operators will have the confidence to fit a gasket on a damaged flange, without the immediate risk of loss of containment.

For flanges in good condition but with a tendency to corrode, utilize the CPR gasket to eliminate all crevices and prevent the onset of corrosion.

- Immediate sealing of existing damage, and prevention against further damage
- Eliminates the expense of in-situ machining and reworking or replacing flanges
- No need for hot work permits or specialized equipment
- Reduced downtime, increased production, reduced costs
- Low seating stress
- Core and facing available in wide range of materials to suit almost any type of application
- Contact Flexitallic Engineering for additional design details.

Important: Pipe schedule required on all designs.

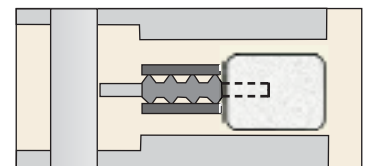

*Eliminate crevices to prevent the onset of corrosion.
Inner ring will not fall out.*

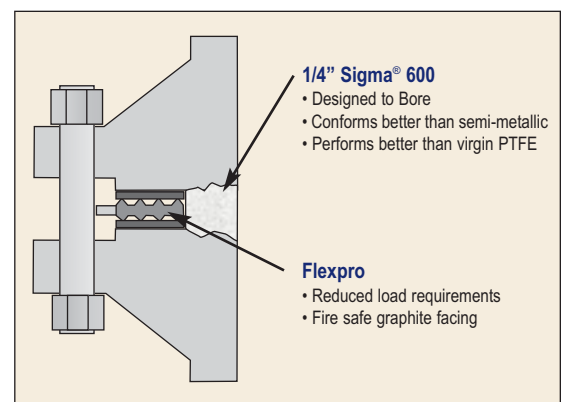

Resist further corrosion

Ring Type Joint (RTJ)

The ring type joint was initially developed for use in the petroleum industry, where high pressure/temperature applications necessitated the need for a high integrity seal. They are mainly used in the oil field on drilling and completion equipment. Ring type joints are also commonly used on valves and pipework assemblies, along with some high integrity pressure vessel joints.

Style R

The Style R ring type joint is manufactured in accordance with API 6A and ASME B16.20, to suit API 6B and ASME B16.5 flanges.

Style R ring type joints are manufactured in both oval and octagonal configurations. Both styles are interchangeable on the modern flat bottom groove, however only the oval style can be used in the old type round bottom groove.

Style R ring type joints are designed to seal pressure up to 6,250 psi in accordance with ASME B16.5 pressure ratings and up to 5,000 psi in accordance with API 6A pressure ratings.

Style RX

The Style RX ring type joint is manufactured in accordance with API 6A and ASME B16.20, to suit API 6B and ASME B16.5 flanges.

The Style RX is designed to fit the modern flat bottom groove, and is interchangeable with the standard Style R ring type joint. However, since the Style RX is significantly taller than a Style R, larger flange make up distances will result.

Style RX ring type joints are designed to seal pressures up to 6,250 psi in accordance with ASME B16.5 pressure ratings, and up to 5,000 psi in accordance with API 6A pressure ratings. Selected sizes incorporate a pressure passage hole to allow for pressure equalization each side of the sealing faces.

Style BX

The Style BX ring type joint is manufactured in accordance with API 6A.

All BX ring type joints incorporate a pressure passage hole to allow for pressure equalization each side of the sealing faces. On assembly, metal to metal contact of the flange faces is achieved. The Style BX is not interchangeable with any other style, and is only suited for API 6BX flanges. Style BX ring type joints are designed to seal pressure up to 20,000 psi in accordance with API 6A pressure ratings.

Styles SRX and SBX

Styles SRX and SBX are derived from Styles RX and BX, and are produced in line with the API Standard 17 D for use on subsea wellhead and Christmas tree equipment.

Octagonal with Grooves

This style is an octagonal ring with serrations machined on the flat corners as shown in the diagram. The serrated surface then is faced with soft conformable facing.

Style R

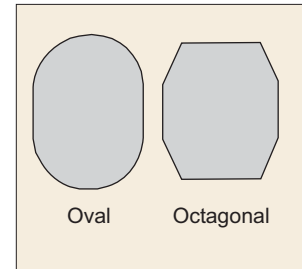

Style RX

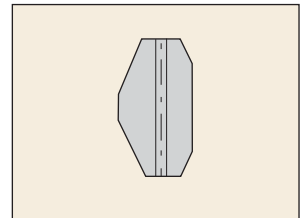

Style BX

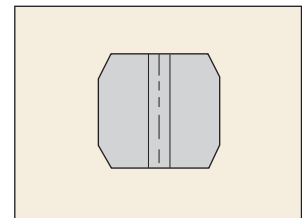

Octagonal with Grooves

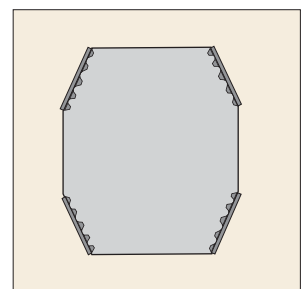

Ring Type Joint (RTJ)

How They Work

Under axial compressive load, ring type joints plastically deform and flow into the irregularities of the flange groove. Since the load bearing area of the ring type joint is relatively small, very high surface stresses result between the sealing faces of the ring type joint and the groove. These stresses are further increased on the Style RX and BX rings which allows for very high internal pressures to be sealed.

Since ring type joints are solid metal, their recovery characteristics are poor. The seal is maintained by the action of axial load upon the gasket.

Surface Finish Requirements

With all metal to metal type seals, it is imperative that the gasket and groove sealing faces are free from indentations, score marks, tool/chatter marks and other imperfections. The surface finish of the gasket and groove sealing faces is also critical and should not exceed the following:

Style R and RX	63 microinches Ra maximum (1.6 micrometer Ra)
Style BX	32 microinches Ra maximum (0.8 micrometer Ra)

Reuse

Ring type joints are designed to have a limited amount of positive interference, which ensures that the ring type joint seats correctly into the groove on compression. Their reuse is not recommended for two reasons:

- The initial seating of the gasket will be impaired.
- When the gasket is plastically deformed, work hardening of the external metal surface occurs. This may result in permanent damage to the groove.

Hardness of Materials

On compression of the flange assembly, it is imperative that the ring type joint be significantly softer than the flange groove so that the gasket plastically deforms and not the groove. The use of harder ring type joints can result in flange groove damage. For this reason, ring type joints are supplied with the following maximum hardness values:

Material	Werkstoff Number	Maximum Hardness		Identification
		Brinell*	Rockwell B†	
Soft Iron		90	56	D
Low Carbon Steel		120	68	S
4 - 6% Chrome 1/2% Moly.		130	72	F5
Type 304 Stainless Steel	1.4301	160	83	S304
Type 316 Stainless Steel	1.4401	160	83	S316
Type 347 Stainless Steel	1.4550	160	83	S347
Type 410 Stainless Steel	1.4006	170	86	S410

* Measured with 3000Kg load except soft iron which is measured with 500Kg load

† Measured with 100 Kg load and 1/16" diameter ball.

Some materials can be supplied with NACE certification on request.

Protective Coating

In accordance with API Specifications, soft iron, low carbon steel, and other ferrous materials ring type joints are protected from corrosion with electroplated zinc to a maximum thickness of 0.0005". Alternative material coatings can be supplied on request.

Specialized Ring Type Joint

For critical and non standard applications, where ring type joints are unsuitable in their standard form, Flexitallic offers a range of specialized ring type joint gaskets to suit the needs of the petrochemical industry.

Style R Ring Type Joints with PTFE Inserts

Oval and octagonal ring type joints can be supplied with a PTFE insert which is located in a machined recess in the bore of the gasket. The insert reduces turbulent flow across adjoining flanges and also eliminates flange/gasket erosion which can occur with high velocity fluids.

Style RX Ring Type Joints with PTFE Inserts

Style RX ring type joints can also be supplied with PTFE inserts, in order to reduce turbulent flow and eliminate gasket/flange erosion. The insert is specially designed with radially drilled pressure passage holes so that the self sealing performance of the RX Ring Joint is not impaired.

Rubber Coated Ring Type Joints

This is an oval ring type joint which is totally enclosed in a nitrile rubber coating. The ring type joint material is usually soft iron or low carbon steel. This type of gasket has three main functions:

- It is used in pressure testing to minimize damage to flanges.
- The rubber contact points provide additional seals while protecting the flange surfaces.
- It provides increased assurance against corrosion, which can occur between conventional ring type joints and the engaged surfaces of the groove.

Transition Ring Type Joints

These are combination rings which consist of two different sizes having the same pitch circle diameter. They are used for sealing ring type joint flanges where the mating flanges have different ring groove diameters. Transition ring type joints are available with either oval or octagonal facings.

Blind Ring Type Joints

Special ring type joints can be manufactured to blank off flanges and pipework. They consist of standard ring type joints with integral solid metallic centers.

Flange Guards

Flange guards are supplied to suit all API, ASME, BS and MSS SP44 ring type joint flanges. Flange guards are manufactured from closed cell neoprene foam, which compresses readily under load. Once assembled, they protect the outside diameter of the ring type joint in corrosive environments e.g. salt spray.

Style R with PTFE Inserts

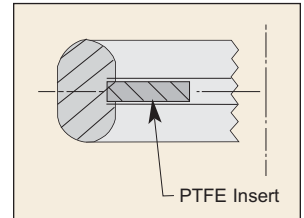

Style RX with PTFE Inserts

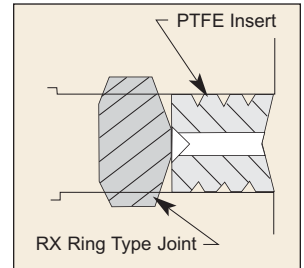

Rubber Coated RTJ

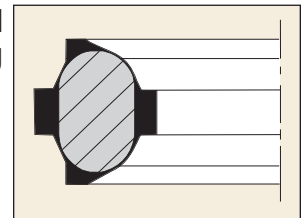

Transition RTJ

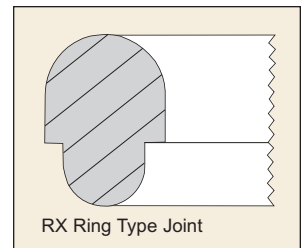

Blind RTJ

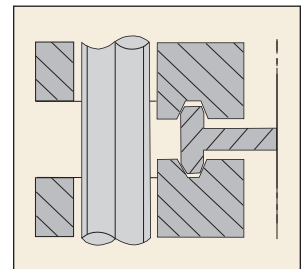

Flange Guards



Lens Ring

In certain applications, the specification of a high integrity metallic seal has usually lead to the selection of the Lens Ring concept, rather than the more generally recognized ring type joint solution. The Lens Ring is covered solely by the DIN 2696 specification. However, ASME B16.5 and other flange types can be modified to accept the Lens Ring.

The Lens Ring provides a metallic gasket design incorporating spherical seating faces designed to suit specifically mating flange recesses, providing the user with a high integrity, high pressure/temperature metal to metal seal.

As with all metallic gaskets, the Lens Ring material should be specified softer than the flange material, thus ensuring applied compressive load leads to the elastic/plastic deformation of the lens ring and not the flange sealing face. The distribution of high compressive loads leads to the spread of the gasket facings, ensuring over stressing of the gasket is prevented.

In accordance with DIN 2696 general materials are limited to a range of specified carbon steels and stainless steel grades, although alternative grades are available upon request. Flexitallic requires a detailed drawing be supplied when ordering non standard Lens Rings.

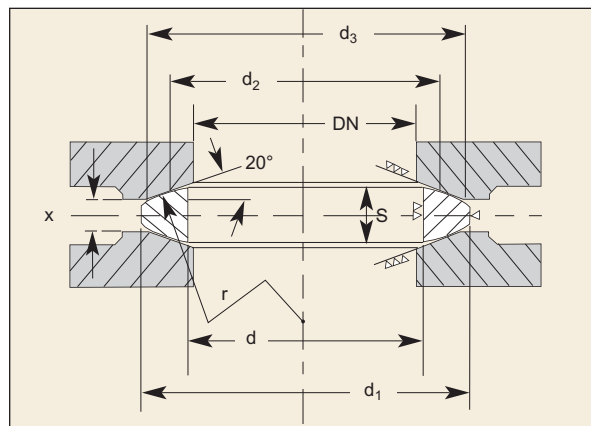

DIMENSIONS IN MILLIMETERS

NPS size DN	d		d_1	S for d max	d_2 middle contact diameter	r	d_3	x
	min	max						
Nominal pressure PN64 - 400								
10	10	14	21	7	17.1	25	18	5.7
15	14	18	28	8.5	22	32	27	6
25	20	29	43	11	34	50	39	6
40	34	43	62	14	48	70	55	8
50	46	55	78	16	60	88	68	9
65	62	70	102	20	76.6	112	85	13
80	72	82	116	22	88.2	129	97	13
100	94	108	143	26	116	170	127	15
125	116	135	180	29	149	218	157	22
150	139	158	210	33	171	250	183	26
Nominal Pressure PN64 and 100								
[175]	176	183	243	31	202.5	296	218	28
200	198	206	276	35	225	329	243	27
250	246	257	332	37	277.7	406	298	25
300	295	305	385	40	323.5	473	345	26
350	330	348	425	41	368	538	394	23
400	385	395	475	42	417.2	610	445	24
Nominal pressure PN160 - 400								
[175]	162	177	243	37	202.5	296	218	21
200	183	200	276	40	225	329	243	25
250	230	246	332	46	277.7	406	298	25
300	278	285	385	50	323.5	473	345	30
Avoid nominal pipe sizes in brackets.								

Weld Gasket

Another gasket concept with origins from the German industrial market are weld gaskets. As standard, two variants exist; Weld Membrane Gaskets in accordance with DIN 2695 and Weld Ring gaskets.

Weld Membrane Gaskets

The Weld Membrane Gasket consists of two similar rings each of 0.157" (4mm) thickness. For chemical compatibility and in order to ensure controlled thermal conductivity and weld compatibility, the gasket material must always be the same as the flange material. Each ring is individually welded to its mating flange. Upon flange assembly, a second welding operation joins the two rings at their outer diameter which provides for a fully welded joint.

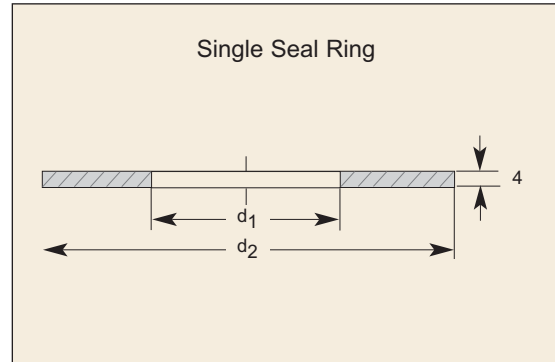
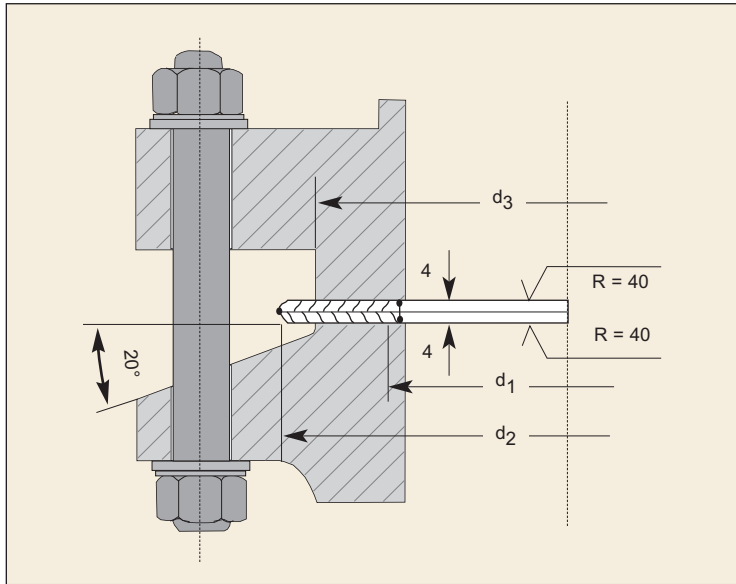

Weld Ring Gaskets

As with Weld Membrane Gaskets, Weld Ring Gaskets are used in pairs. As standard, each ring is manufactured to similar materials to that of the flange, thus ensuring full compatibility. All welding can be conducted on the outside of the gasket and flange, thus ensuring ease of location, especially in restricted applications where space is limited. Two styles exist, Style SR and Style SRL. Style SRL is recommended when there is flange differential radial expansion.

Style SR

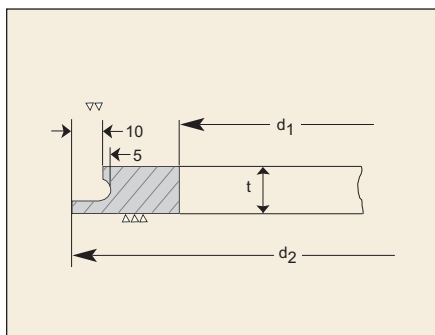

Style SRL

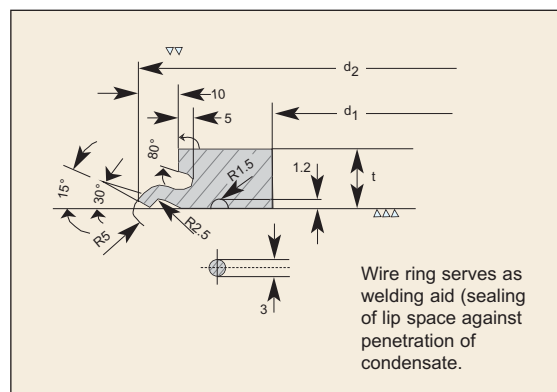

SECTION II

Joint Integrity Calculations

This section is designed to enable a flange designer or gasket user to:

1. Calculate a bolt stress required for a particular gasket in a known flange.
2. Modify both gasket and bolting parameters in the relevant calculations to arrive at a suitable gasket type and dimension, and bolt pattern to suit a given application.

A Torque Guide is included to enable the user to obtain a torque figure once the bolt stress has been calculated.

See the installation section for a controlled bolting procedure in which to apply these torque values.

Gasket Type

The engineer must always be aware of the abilities and limitations of the gasket types and materials. Factors such as blow out resistance, creep resistance, stress retention, recovery characteristics and cost must be considered.

Application

When determining the type of gasket to be used, design pressures and temperatures must always be considered. Media will further dictate gasket selection and what materials may or may not be utilized, ensuring chemical compatibility. Always consider special conditions such as thermal cycling, thermal shock, vibration, and erosion.

Flange Design

Attention to the flange design is critical when designing a gasket. Flange configuration, available bolt load and materials all have obvious effects on gasket selection. Flange configuration determines the style and basic dimensions of the gasket. Compatibility between flange and gasket material must be ensured, thus minimizing the possibility of galvanic corrosion.

When a joint assembly is placed in service, three basic forces become active and affect overall sealing performance.

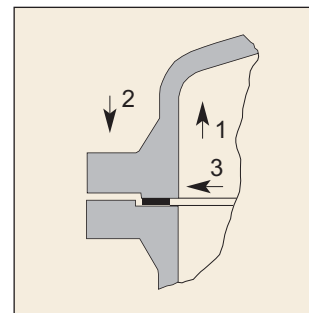

1) END FORCE -	Which originates with the pressure of confined gases or liquids that tends to separate the flange faces.
2) GASKET LOAD -	The function of the bolting or other means which applies force upon the flange faces to compress the gasket and withstand internal pressure
3) INTERNAL PRESSURE -	Force which tends to move, permeate or bypass the gasket.

Taking the above factors into consideration, attention must be paid to the initial force applied to a joint. Firstly, the applied preload must be sufficient to seat the gasket upon the flange faces, compensating for any surface imperfections which may be present. Secondly, the force must be sufficient to compensate for the internal pressures acting against the flange assembly. i.e. the hydrostatic end force and internal pressure. Finally, the applied force must be sufficient to maintain a satisfactory residual load upon the joint assembly.

ASME Boiler and Pressure Vessel Code Calculations

Section VIII of the ASME Boiler & Pressure Vessel Code, establishes criteria for flange design and suggests values of "m" (gasket factor) and "y" (minimum gasket seating stress) as applied to gaskets. For the most part, the defined values have proven successful in actual applications. However, much confusion exists regarding these values, primarily due to a misunderstanding of the definitions of the terms and their significance in practical applications. Mandatory Appendix II, in Section VIII of the Boiler Code, requires in the design of a bolted flange connection, that complete calculations shall be made for two separate and independent sets of conditions.

Operating Conditions

Condition one (1) requires a minimum load be determined in accordance with the following equation:

$$(1) \quad Wm1 = \frac{3.14G^2P}{4} + 2b \ 3.14GmP$$

This equation states the minimum required bolt load for operating conditions and is the sum of the hydrostatic end force, plus a residual gasket load on the contact area of the gasket times a factor times internal pressure. Stated another way, this equation requires the minimum bolt load be such that it will maintain a residual unit compressive load on the gasket area that is greater than internal pressure when the total load is reduced by the hydrostatic end force.

Gasket Seating

Condition two (2) requires a minimum bolt load be determined to seat the gasket regardless of internal pressure and utilizes a formula:

$$(2) \quad Wm2 = 3.14bGy$$

The "b" in these formulae is defined as the effective gasket width and "y" is defined as the minimum seating stress in psi. For example, Section VIII of the Boiler Code suggests a minimum "y" value for a spiral wound gasket of 10,000 psi (Winter 1976 Addenda). These design values are suggested and not mandatory. The term "b" is defined as:

$$b = b_o \text{ when } b_o \leq 1/4" \quad b = 0.5 \sqrt{b_o} \text{ when } b_o > 1/4"$$

After Wm1, and Wm2 are determined, the minimum required bolt area Am is determined as follows:

$$Am1 = \frac{Wm1}{Sb} \text{ where } Sb \text{ is the allowable bolt stress at operating temperature, and}$$

$$Am2 = \frac{Wm2}{Sa} \text{ where } Sa \text{ is the allowable bolt stress at atmospheric temperature.}$$

Then Am is equal to the greater of Am1 or Am2. Bolts are then selected so the actual bolt area, Ab, is equal to or greater than Am.

At this point, it is important to realize the gasket must be capable of carrying the entire compressive force applied by the bolts when prestressed unless provisions are made to utilize a compression stop in the flange design or by the use of a compression gauge ring. For this reason, FLEXITALLIC's standard practice is to assume W is equal to Ab Sa.

We are then able to determine the actual unit stress on the gasket bearing surface. This unit stress Sg is calculated as follows:

$$(3) \quad Sg \text{ (psi)} = \frac{Ab \ Sa}{.785 [(do - .125)^2 - (di)^2]}$$

*Note: Based on 4.5mm (.175") thick spiral wound gasket. The "v" or Chevron shape on the gasket O.D. is not part of the effective seating width, therefore .125" is subtracted from the actual gasket O.D.

Using the unit stress we can assign construction details which will lead to the fabrication of a gasket having sufficient density to carry the entire bolt load.

ASME Boiler and Pressure Vessel Code Calculations

Gasket Seating Stress "y"

Defined as the applied stress required to seat the gasket upon the flange faces. The actual required seating stress is a function of flange surface finish, gasket material, density, thickness, fluid to be sealed and allowable leak rate.

Gasket Factor "m"

Appendix II, Section VIII, of the Boiler Code makes the statement the "m" factor is a function of the gasket material and construction. We do not agree entirely with this interpretation of "m". Actually, the gasket does not create any forces and can only react to external forces. We believe a more realistic interpretation of "m" would be "the residual compressive force exerted against the gasket contact area must be greater than the internal pressure when the compressive force has been relieved by the hydrostatic end force". It is the ratio of residual gasket contact pressure to internal pressure and must be greater than unity otherwise leakage would occur. It follows then, the use of a higher value for "m" would result in a closure design with a greater factor of safety. Experience has indicated a value of 3 for "m" is satisfactory for flanged designs utilizing Spiral Wound gaskets regardless of the materials of construction. In order to maintain a satisfactory ratio of gasket contact pressure to internal pressure, two points must be considered. First, the flanges must be sufficiently rigid to prevent unloading the gasket due to flange rotation when internal pressure is introduced. Secondly, the bolts must be adequately prestressed. The Boiler Code recognizes the importance of pre-stressing bolts sufficiently to withstand hydrostatic test pressure. Appendix S, in the Code, discusses this problem in detail.

Notations	
A_b	= Actual total cross sectional root area of bolts or section of least diameter under stress; square inches
A_m	= Total required cross sectional area of bolts, taken as greater of A_{m1} or A_{m2} ; square inches
A_{m1}	= Total required cross sectional area of bolts required for operating conditions; square inches
A_{m2}	= Total required cross sectional area of bolts required for gasket seating; square inches
b	= Effective sealing width; inches
b_o	= Basic gasket seating width; inches
$2b$	= Joint-contact-surface pressure width; inches
G	= Diameter of location of gasket load reaction; inches
m	= Gasket factor
N	= Radial flange width of spiral wound component
P	= Design pressure; psi
S_a	= Allowable bolt stress at atmospheric temperature; psi
S_b	= Allowable bolt stress at design temperature; psi
W	= Flange design bolt load; pounds
W_{m1}	= Minimum required bolt load for operating conditions; pounds force
W_{m2}	= Minimum required bolt load for gasket seating; pounds force
y	= Minimum gasket seating stress; psi
S_g	= Actual unit stress at gasket bearing surface; psi
d_o	= Outside diameter of gasket; inches
d_i	= Inside diameter of gasket; inches

The ASME boiler and pressure vessel code is currently under review by the Pressure Vessel Research Council. Details of these proposed improvements, including the effects on gasket design procedures are highlighted on page 48.

ASME Boiler and Pressure Vessel Code Calculations

Gasket Materials and Contact Facings

Gasket factors (*m*) for Operating Conditions and Minimum Design Seating Stress (*y*)



Gasket Material	Gasket Factor (<i>m</i>)	Minimum Design Seating Stress (<i>y</i>) (psi)	Sketches and Notes	Seating Width (See Table)	
				Gasket Group	Column
Self-Energizing Types O-rings, metallic, elastomer, and other gasket types considered as self-sealing	0	0			
Elastomers without fabric Below 75A Shore Durometer 75A or higher Shore Durometer	0.50 1.00	0 200		(1a), (1b) (1c), (1d), (4), (5)	II
Elastomers with cotton fabric insertion	1.25	400			
Vegetable fiber	1.75	1100			
Flexicarb products NR SR ST	2.00 2.00 2.00	900 900 2,500			
Thermiculite 815	2.00	2,500		(1a) (1b)	
Thermiculite 715	3.20	4,200		(1a) (1b)	
Change	2.5	6,400		(1a) (1b)	
MRG	2.00	2,500		(1a) (1b)	
Flexpro	2.00	2,500		(1a) (1b)	
Spiral wound metal, with filler	3.00	10,000		(1a), (1b)	
Spiral wound Style LS	3.00	5,000		(1a) (1b)	
Corrugated metal with filler or Corrugated metal jacketed with filler	Soft aluminum Soft copper or brass Iron or soft steel Monel or 4%-6% chrome Stainless steels & Nickel based alloys	2.50 2.75 3.00 3.25 3.50	2900 3700 4500 5500 6500		
Corrugated metal	Soft aluminum Soft copper or brass Iron or soft steel Monel or 4%-6% chrome Stainless steels & Nickel based alloys	2.75 3.00 3.25 3.50 3.75	3700 4500 5500 6500 7600		(1a), (1b), (1c), (1d)
Flat metal jacketed, with filler	Soft aluminum Soft copper or brass Iron or soft steel Monel 4%-6% chrome Stainless steels & Nickel based alloys	3.25 3.50 3.75 3.50 3.75 3.75	5500 6500 7600 8000 9000 9000		(1a) ₂ , (1b) ₂ , (1c), (1d), (2)
Grooved metal	Soft aluminum Soft copper or brass Iron or soft steel Monel or 4%-6% chrome Stainless steels & Nickel based alloys	3.25 3.50 3.75 3.75 4.25	5500 6500 7600 9000 10100		(1a), (1b), (1c), (1d), (2), (3)
Solid flat metal	Soft aluminum Soft copper or brass Iron or soft steel Monel or 4%-6% chrome Stainless steels & Nickel based alloys	4.00 4.75 5.50 6.00 6.50	8800 13000 18000 21800 26000		(1a), (1b), (1c), (1d), (2), (3), (4), (5)
Ring Joint	Iron or soft steel Monel or 4%-6% chrome Stainless steels & Nickel based alloys	5.50 6.00 6.50	18000 21800 26000		(6)

Notes: This table gives a list of many commonly used gasket materials and contact facings with suggested design values of *m* and *y* that have generally proved satisfactory in actual service when using effective gasket seating width *b* given in the table on the next page. The design values and other details given in this table are suggested only and are not mandatory.

The surface of a gasket having a lap should not be against the nubbin.

ASME Boiler and Pressure Vessel Code Calculations

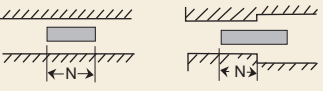
Effective Gasket Seating Width - See Note (1)

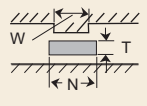
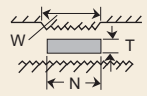
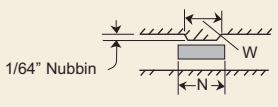
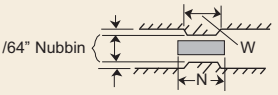
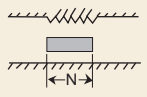
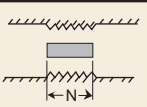
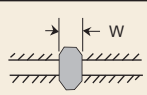
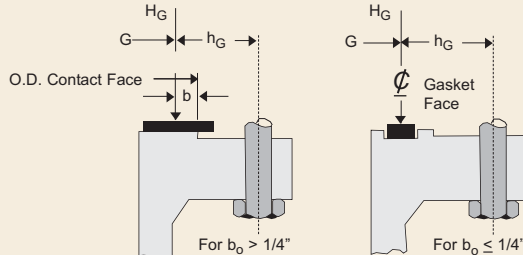
Facing Sketch Exaggerated	Basic Gasket Seating Width, b_o	
	Column I	Column II
(1a) 	$\frac{N}{2}$	$\frac{N}{2}$
(1b)  See Note (2)		
(1c)  $w \leq N$	$\frac{W + T}{2} ; \left(\frac{W + N}{4} \text{ max.} \right)$	$\frac{W + T}{2} ; \left(\frac{W + N}{4} \text{ max.} \right)$
(1d)  $w \leq N$ See Note (2)		
(2)  $w \leq N/2$ 1/64" Nubbin	$\frac{W + N}{4}$	$\frac{W + 3N}{8}$
(3)  $w \leq N/2$ 1/64" Nubbin	$\frac{N}{4}$	$\frac{3N}{8}$
(4)  $w \leq N/2$ See Note (2)	$\frac{3N}{8}$	$\frac{7N}{16}$
(5)  $w \leq N/2$ See Note (2)	$\frac{N}{4}$	$\frac{3N}{8}$
(6)  $w \leq N/2$	$\frac{W}{8}$	
Effective Gasket Seating Width, b		
$b = b_o$, when $b_o \leq 1/4"$; $b = 0.5 \sqrt{b_o}$, when $b_o > 1/4"$		
Location of Gasket Load Reaction		
		

Notes:
 (1) The gasket factors listed only apply to flanged joints in which the gasket is contained entirely within the inner edges of the bolt holes.
 (2) Where serrations do not exceed 1/64" depth and 1/32" width spacing, sketches (1b) and (1d) shall be used.

PVRC METHOD

Current gasket design calculations for bolted joints such as ASME VIII, DIN 2505, etc., have many shortcomings surrounding the expected tightness and optimum operating stress levels to ensure against joint leakage. In general, current design methods only ensure that the optimum bolt load is available to seat the gasket and accommodate the hydraulic loads created by the internal pressure. Little information is given regarding the tightness of the joint in service or the optimum level of gasket stress to fulfill the legislative, environmental and company emission requirements at the source of application.

Flexitallic financially supports, and is actively involved in the research efforts of the ASME's Pressure Vessel Research Council (PVRC) to review and update current gasket design methodology. The PVRC has, through many years of research and development (involving hundreds of actual gasket tests), conceived a new philosophy that addresses the mechanisms of sealing that will benefit gasket manufacturers, vessel designers and the operators of process equipment in general.

The result is a package that recommends minimum levels of gasket assembly stress to fulfill the operational requirements of the user. The new procedure is similar to the existing ASME Section VIII calculation, except it incorporates new gasket factors (to replace the traditional m & y gasket factors) that have been determined through an extensive test program.

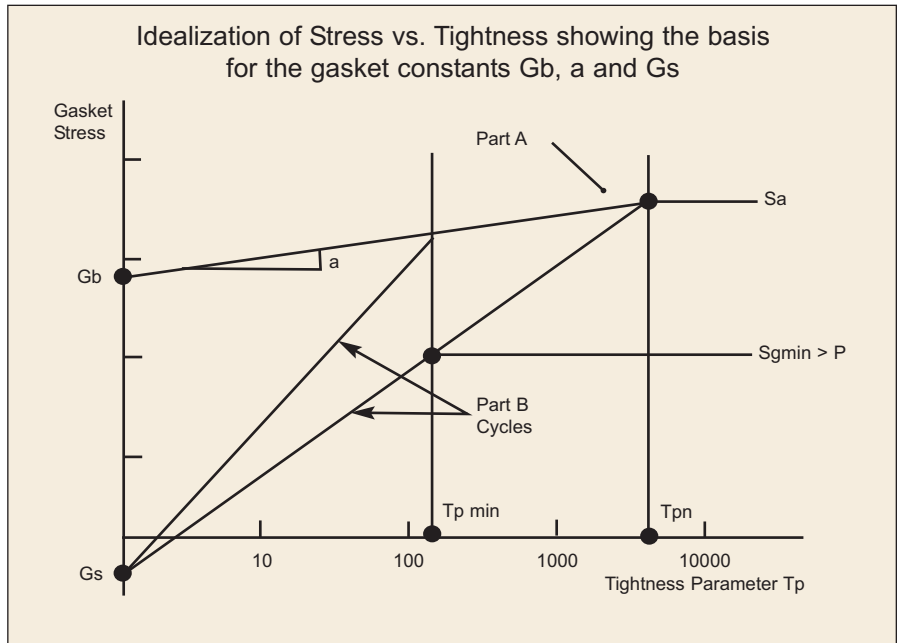

The new gasket factors are (G_b) , (a) , and (G_s) .

(G_b) and (a) represent the initial gasket compression characteristics and relate to the initial installation, while (G_s) represents the unloading characteristics typically associated with the operating behavior.

The PVRC method has been developed over the years using the following parameters for bolted joint designs and determining gasket constants:

1. Determine the tightness class 'Tc' that corresponds to the acceptable leak rate for the application (legislative, environmental, or company emission legislation).
 T2: Standard; represents a mass leak rate per unit diameter of 0.002 mg/sec/mm-dia.
 T3: Tight; represents a mass leak rate per unit diameter of 0.00002 mg/sec/mm-dia.
2. Select the tightness constant that corresponds to the chosen tightness class
 $C = 1.0$ for tightness class T2 (Standard).
 $C = 10.0$ for tightness class T3 (Tight).
3. Select the appropriate gasket constants (G_b) , a , and (G_s) for the gasket style and material, (see table, page 49).
4. Determine gasket parameters (N) , (b_o) , (b) , and (G) as per table (page 46).
5. Gasket seating area, $A_g = 0.7854(OD^2-ID^2)$.
6. Hydraulic area, $A_i = 0.7854G^2$
7. Minimum required tightness, $T_{pmin} = 0.1243 \times C \times P_d$, $P_d =$ Design Pressure
8. Assembly Tightness $T_{pa} = 0.1243 \times C \times P_t$, $P_t =$ Test Pressure (Typically $1.5 \times P_d$)
9. Tightness Parameter Ratio, $Tr = \text{Log}(T_{pa})/\text{Log}(T_{pmin})$
10. Gasket Operating Stress, $S_{m1} = G_s[G_b/G_s \times T_{pa}^a]^{1/Tr}$

PVRC Method

11. Gasket Seating Stress, $S_{m2} = G_b (T_{pa}^a) / (e \times 1.5) - P_d (A_i/A_g)$

$e = 0.75$ for manual bolt up

$e = 1.0$ for hydraulic tensioners & ultrasonic

12. Design factor, $M_o = \text{the greater of } S_{m1}/P_d \text{ or } S_{m2}/P_d$

13. Design Bolt load, $W_{m0} = A_g \times S_{m0} + A_i \times P_d$

S_{m0} is the greater of $S_{m1}, S_{m2}, 2P, S_L$

S_L = A minimum permitted value of operating gasket stress equal to 90% of the minimum gasket stress in the test that determined the gasket constants. It is 6.21 MPa (900 psi) for the standard and soft ROTT test procedures, and 10.3 MPa (1500 psi) for the hard gasket procedure.

Note: Iterative method can be used for more exact results ($S_{m1} - S_{m2}$). Additionally, computer software equation solvers allow for the solving thru iteration of equation(s) based upon T_{pa} and S_{ga} . Contact Flexitallic Engineering for additional information.

Note: PVRC and ASME continue to refine data reduction techniques, and values are therefore subject to further review and revisions.

Gasket Factors

Type	Material	G_b (psi)	a	G_s (psi)
Spiral Wound 'LS' (Class 150 & 300)	SS/Flexicarb	598	0.385	0.03
	SS/PTFE	698	0.249	0.00128
Spiral Wound (Class 150 to 2500)	SS/Flexicarb	2300	0.237	13
	SS/Flexite Super	2600	0.230	15
	SS/Thermiculite® 835	2120	0.190	49
MRG Carrier Ring Flexpro	SS/Flexicarb	813	0.338	0.2
	SS/Flexicarb	1251	0.309	11
	SS/Flexicarb	387	0.334	14
	SS/Thermiculite® 845	1780	0.169	1080
Sheet Gaskets (Class 150 to 300)	Flexicarb ST	1400	0.320	0.01
	Flexicarb SR	816	0.380	0.07
	SF 2401	290	0.383	2.29
	SF 3300	2360	0.190	50.25
	Sigma® 500	4	0.804	0.115
	Sigma® 511	209	0.356	0.00498
	Sigma® 522	472	0.250	0.037
	Sigma® 533	115	0.382	0.000065
	Thermiculite® 715	1031	0.243	9.68
	Thermiculite® 815	1906	0.200	456
Corrugated Gasket	Soft Iron	3000	0.160	115
	Stainless Steel	4700	0.150	130
	Soft Copper	1500	0.240	430
Metal Jacketed	Soft Iron	2900	0.230	15
	Stainless Steel	2900	0.230	15
	Soft Copper	1800	0.350	15
Metal Jacketed Corr.	Soft Iron	8500	0.134	230
Change Gasket	304/Flexicarb	1124	0.250	16.1

Please contact Flexitallic Technical Department for the gasket constants of newly developed gaskets.

SECTION III

Gasket Installation

A FLEXITALLIC gasket will provide a reliable seal when properly installed in the application for which it was designed. Please remember that the performance of a bolted joint is not solely dependent on the gasket itself, but on a combination of variables, many of which are outside the control of the gasket manufacturer. Experience has shown that leakage is not necessarily a sole indication of a faulty gasket, but is more likely to be the result of improper installation, assembly or bolting practices, damaged flanges, or a combination of the myriad of variables associated in a bolted gasketed assembly. When installing the gasket the following are to be considered:

Gasket Quality

Obviously gasket quality is important. Always deal with reputable suppliers and/or manufacturers who are capable of high quality products and sound technical support.

NEVER INSTALL A PREVIOUSLY USED GASKET!

Flange Surfaces

The condition of flange surfaces, as well as the proper flange material selection play an important part in achieving a leak-free joint assembly. Assure that the following are within acceptable limits:

- Surface finish
- Flatness
- Parallelism
- Waviness
- Surface imperfections

For optimum gasket performance Flexitallic recommends that the flange surface finishes listed in the table on page 48 be used for the respective gasket selected. To assure proper and even compression of the gasket we recommend that parallelism be within 0.2 mm (0.008”), flatness and waviness are kept at better than 0.2 mm (0.008”). We suggest that the allowable imperfections do not exceed the depth of the surface finish grooves, and that any radial marks are no deeper than the depth of the flange surface finish and less than 50% in length of the overall gasket sealing surface width. Refer to ASME PCC-1 for guidelines on parallelism, flatness, waviness, and acceptable blemishes.

Fasteners

It is important that the proper studs/bolts and nuts are selected to assure joint integrity. Improper selection of these may compromise the entire joint assembly. The following list is to be considered when selecting fasteners:

- Type
- Grade
- Class
- Proper material
- Appropriate coating or plating
- Correct stud/bolt length

See the table on page 60 for temperature rating of stud/bolt grades.

Assembly

In an effort to achieve a high degree of success in attaining a leak-free joint several steps are required. It is imperative that a regimented bolt up procedure is applied. As a minimum the following is suggested:

- Install a new gasket on the gasket seating surface and bring the mating flange in contact with the gasket.
- Do not apply any compounds on the gasket or gasket seating surfaces.
- Install all bolts, making sure that they are free of any foreign matter, and well lubricated. Lubricate nut bearing surfaces as well. (Lubrication will not be required for PTFE coated fasteners.)
- Run-up all nuts finger tight.
- Develop the required bolt stress or torque incrementally in a minimum of four steps in a crisscross pattern. The initial pre-stress should be no more than 30% of the final required bolt stress. After following this sequence, a final tightening should be performed bolt-to-bolt to ensure that all bolts have been evenly stressed.

Note: The use of hardened washers will enhance the joint assembly by reducing the friction due to possible galling of the nut bearing surfaces.

Note: See page 58 for information on our Flange Assembly and Proper Bolting Procedures Seminar.

Bolt Torque Sequence

For critical applications a more sophisticated method for bolt up may be considered such as heating rods, bolt tensioners, or ultrasonic extensometer.

Bolting Up Sequence

Upon initially placing the gasket into the flange assembly and installing the studs or bolts and hand tightening the nuts, check the gasket position to ensure it is centered and that the gap between the flanges is uniform. Apply a relatively low torque (5 - 51 lb.-ft. depending upon bolt size, but less than 15-20% of final torque) to help set the gasket into position and recheck the flange gap to ensure it is reasonably uniform. Follow the 4 step sequence below to complete flange make-up.



Stage 1 - Torque bolts up to approximately 30% of the final torque value following the diametrically opposed sequence specified on pages 49 and 50.

Stage 2 - Repeat Stage 1, increasing the torque value to approximately 60% of the final torque value.

Stage 3 - Repeat Stage 2, increasing the torque value to the final required torque value.

Stage 4 - A final tightening should be performed following an adjacent bolt-to-bolt sequence to ensure that all bolts have been evenly stressed. Note that the Stage 4 'leveling pass' may require more than one complete pass. Continue on the 'leveling pass' until the torque wrench clicks on every stud at the final specified torque value. If not using torque wrenches, continue tightening in a bolt-to-bolt sequence until there is no additional movement of the nuts when applying the same amount of effort on each nut.

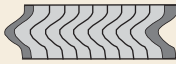
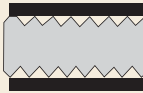
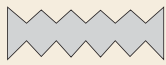
Note: For additional information refer to ASME PCC-1 latest edition.

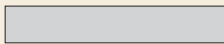
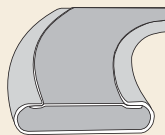
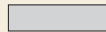
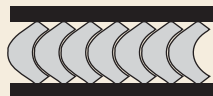
Surface Finish Requirements	Gasket Description	Gasket Cross Section	Flange Surface Finish Microinch Ra	Flange Surface Finish Micrometer Ra
	Spiral Wound Gaskets		125 - 250	3.2 - 6.3
Flexpro Gaskets		125 - 250	3.2 - 6.3	
Metallic Serrated Gaskets		63 MAX	1.6 MAX	
MRG		125 - 250	3.2 - 6.3	
Solid Metal Gaskets		63 MAX	1.6 MAX	
Metal Jacketed Gaskets		100 - 125	2.5 MAX	
Soft Cut Sheet Gaskets		Mat'l < 1.5mm Thick 125 - 250	Mat'l < 1.5mm Thick 3.2 - 6.3	
		Mat'l ≥ 1.5mm Thick 125 - 500	Mat'l ≥ 1.5mm Thick 3.2 - 12.5	
Change Gaskets		125 - 250	3.2 - 6.3	

Important - Under no circumstances should flange sealing surfaces be machined in a manner that tool marks would extend radially across the sealing surface. Such tool marks are practically impossible to seal regardless of the type of gasket used.

Bolt Torque Sequence

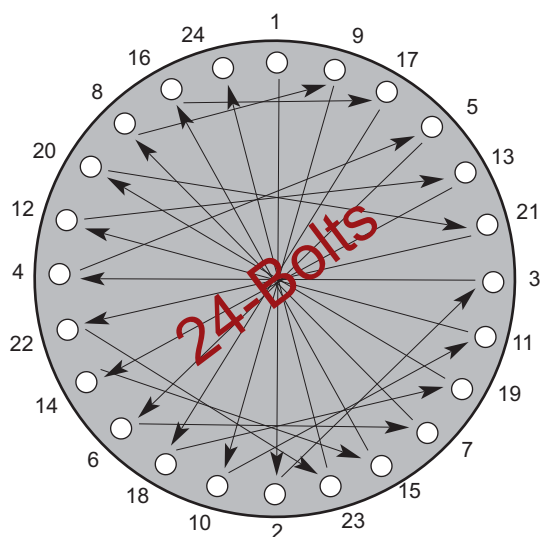
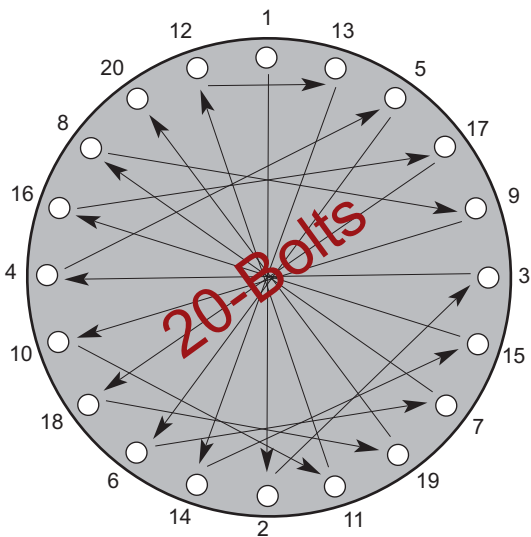
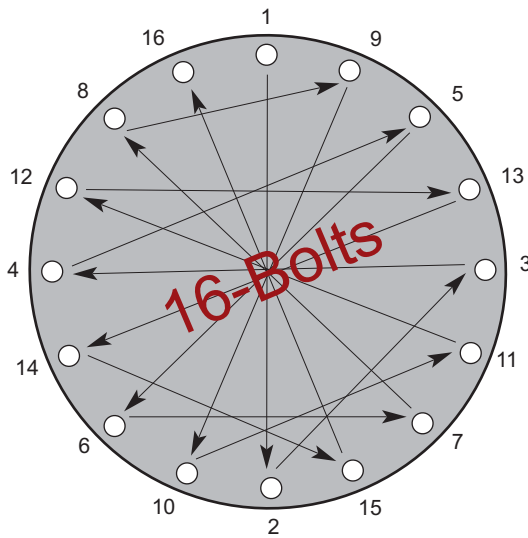
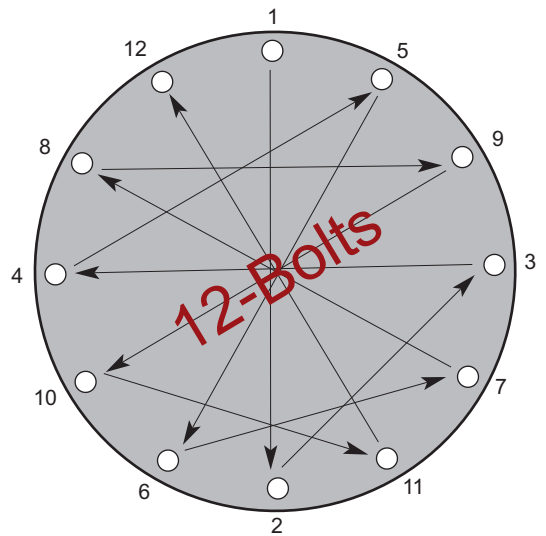
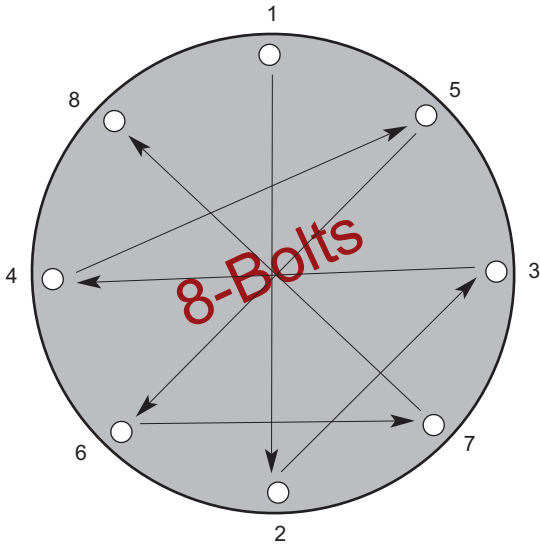

Bolt Torque Sequence

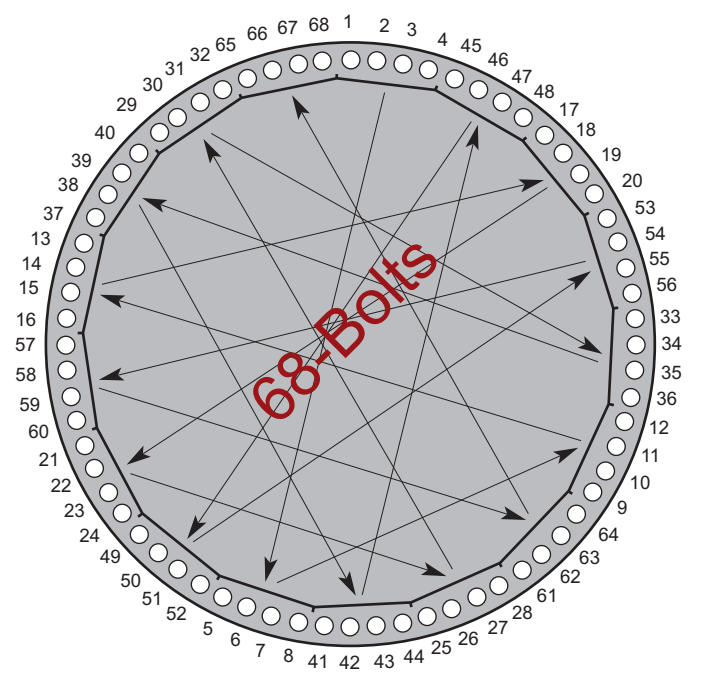
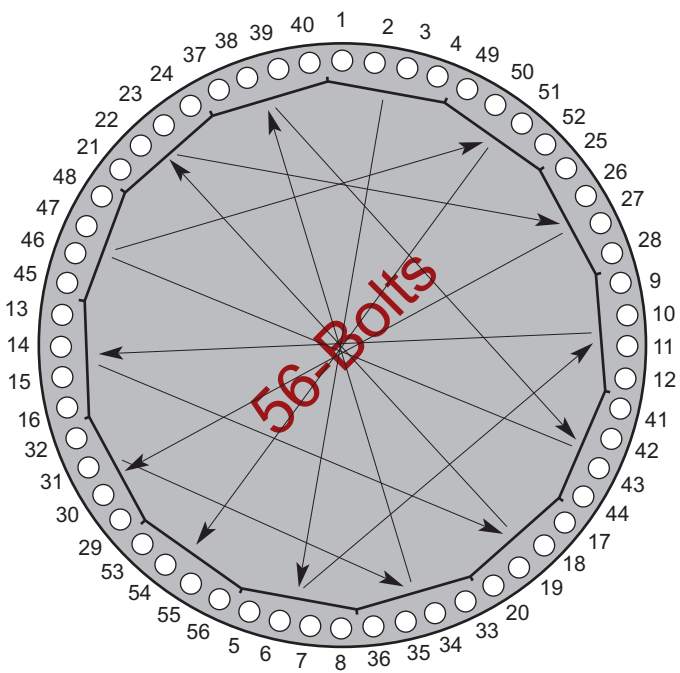
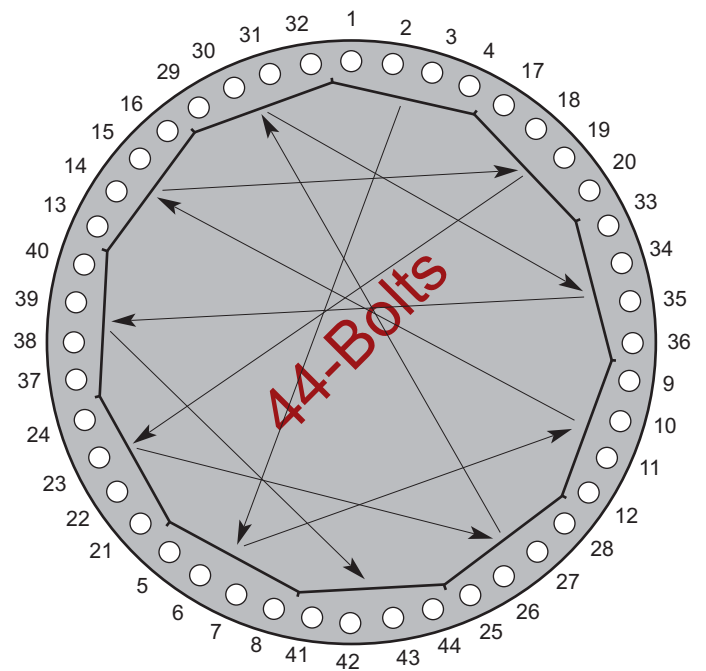
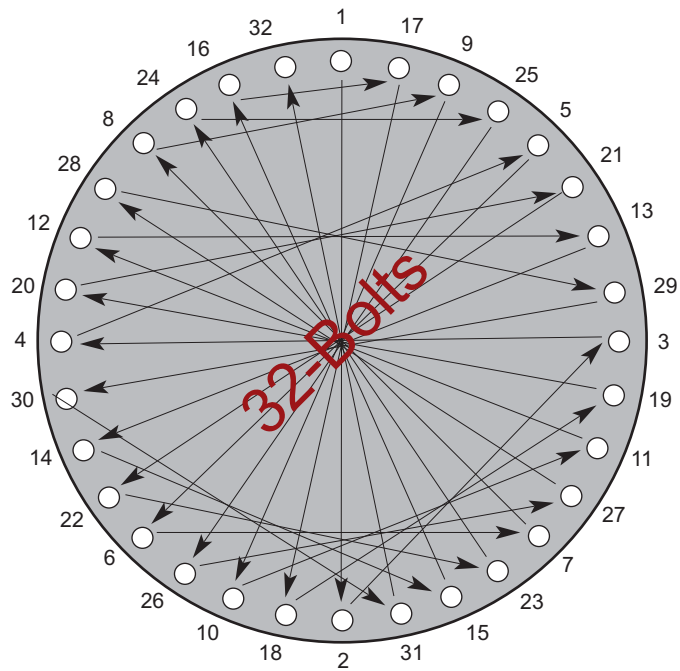

Recommended Torque

Torque Table for CG Spiral Wound Gaskets

NPS (in.)	Class 150		Class 300		Class 400		Class 600	
	Min Torque	Max Torque	Min Torque	Max Torque	Min Torque	Max Torque	Min Torque	Max Torque
0.5	30	40	30	40	30	40	30	40
0.75	30	40	60	70	60	70	60	70
1	30	40	60	70	60	70	60	70
1.25	30	40	60	70	60	70	60	70
1.5	30	60	100	120	100	120	100	120
2	60	90	60	70	60	70	60	70
2.5	60	110	100	120	100	120	100	120
3	90	120	100	120	100	120	100	120
3.5	60	90	100	120	160	190	170	210
4	70	120	100	140	160	200	190	240
5	100	160	110	160	210	260	280	360
6	130	200	110	160	190	240	260	330
8	180	200	180	260	310	400	400	510
10	170	320	250	290	340	440	500	590
12	240	320	360	420	510	640	500	610
14	300	490	360	420	500	890	680	800
16	310	490	500	590	680	800	800	940
18	500	710	500	680	680	810	1100	1290
20	430	710	500	740	800	940	1100	1290
24	620	1000	800	1030	1500	1750	2000	2340

NPS (in.)	Class 900		Class 1500		Class 2500	
	Min Torque	Max Torque	Min Torque	Max Torque	Min Torque	Max Torque
0.5	70	120	70	120	50	100
0.75	70	120	70	120	70	100
1	110	190	110	190	110	160
1.25	110	190	135	190	210	250
1.5	170	290	200	290	310	360
2	110	190	130	190	220	250
2.5	170	290	190	290	300	360
3	140	230	265	360	460	500
4	255	420	415	520	Not Applicable Use CGI	
5	360	600	585	800		
6	300	500	530	680		
8	485	800	845	1100		
10	505	800	1565	2000		
12	570	850	Not Applicable Use CGI			
14	630	940				
16	910	1290				
18	1570	2340				
20	1745	2570				
24	Not Applicable Use CGI					

Notes:

Torque Values are in ft.-lbs., and assume Alloy Steel Bolts (A193 B7 w/ 2H Nuts) with oil/graphite lubrication.

(Nut factors used on these charts are within .15 to .19)

Flexitallic does not generally recommend a bolt stress above 60,000 PSI.

Torque values limit minimum and maximum gasket seating stresses based upon pressure class and certain operating conditions. (i.e: maximum pressure ratings for given pressure class, not hydrotest pressure), Extreme operating conditions such as high temperature may reduce bolt yield strength. Caution should be used in these applications. The above torque values are for general use only. For critical or extreme applications (high temperature/pressure) consult with Flexitallic engineering.

Flexitallic does not accept responsibility for the misuse of this information.

Recommended Torque

Torque Table for CGI Spiral Wound Gaskets

NPS (in.)	Class 150		Class 300		Class 400		Class 600	
	Min Torque	Max Torque	Min Torque	Max Torque	Min Torque	Max Torque	Min Torque	Max Torque
0.5	30	50	30	40	30	40	30	40
0.75	30	50	60	80	60	80	60	80
1	30	60	60	80	60	80	60	80
1.25	30	60	60	80	60	80	60	80
1.5	30	60	100	140	100	140	100	140
2	60	120	60	80	60	80	60	80
2.5	60	120	100	140	100	140	100	140
3	90	120	100	150	100	150	100	150
3.5	60	120	100	170	160	290	170	290
4	70	120	100	200	160	320	190	320
5	100	200	110	200	210	320	280	490
6	130	200	110	200	190	320	260	460
8	180	200	180	320	310	490	400	700
10	170	320	250	460	360	710	500	800
12	240	320	360	700	510	1000	500	850
14	300	490	360	610	500	870	680	950
16	310	490	500	920	680	1250	800	1210
18	490	710	500	1000	680	1340	1100	1790
20	430	710	500	1000	800	1430	1100	1640
24	620	1000	800	1600	1500	2270	2000	2670

NPS (in.)	Class 900		Class 1500		Class 2500	
	Min Torque	Max Torque	Min Torque	Max Torque	Min Torque	Max Torque
0.5	70	120	70	120	50	100
0.75	70	120	70	120	63	100
1	110	190	110	190	110	160
1.25	110	190	140	190	210	250
1.5	170	290	200	290	310	360
2	110	190	130	190	220	250
2.5	170	290	190	290	300	360
3	140	230	270	360	460	500
4	260	420	420	520	710	800
5	360	600	590	800	1280	1500
6	300	500	530	680	1870	2200
8	485	800	850	1100	1780	2200
10	505	800	1570	2000	3040	4400
12	560	850	1500	2200	4610	5920
14	630	940	2120	3180		
16	910	1290	2940	4400		
18	1570	2340	3950	5920		
20	1745	2570	5150	7720		
24	2945	5140	8340	12500		

Notes:
 Torque Values are in ft.-lbs., and assume Alloy Steel Bolts (A193 B7 w/ 2H Nuts) with oil/graphite lubrication.
 (Nut factors used on these charts are within .15 to .19)
 Flexitallic does not generally recommend a bolt stress above 60,000 PSI.
 Torque values limit minimum and maximum gasket seating stresses based upon pressure class and certain operating conditions. (i.e. maximum pressure ratings for given pressure class, not hydrotest pressure). Extreme operating conditions such as high temperature may reduce bolt yield strength. Caution should be used in these applications. The above torque values are for general use only. For critical or extreme applications (high temperature/pressure) consult with Flexitallic engineering.
 Flexitallic does not accept responsibility for the misuse of this information.

Recommended Torque

Torque Table for Flexpro Gaskets

NPS (in.)	Class 150		Class 300		Class 400		Class 600	
	Min Torque	Max Torque	Min Torque	Max Torque	Min Torque	Max Torque	Min Torque	Max Torque
0.5	15	50	30	45	30	40	30	45
0.75	15	50	30	80	60	80	60	80
1	15	60	30	90	60	80	60	85
1.25	30	60	50	120	60	100	60	120
1.5	30	60	65	200	100	135	100	200
2	60	120	45	120	60	80	60	120
2.5	60	120	65	200	100	135	100	180
3	90	120	90	200	100	175	100	200
3.5	60	120	100	200	160	225	160	320
4	75	120	100	200	160	290	160	320
5	100	200	100	200	160	320	245	490
6	120	200	100	200	160	320	245	490
8	160	200	160	300	245	490	355	710
10	160	320	240	490	355	586	500	940
12	160	320	300	710	500	770	500	900
14	280	490	300	710	500	670	680	1070
16	245	490	420	1000	680	1005	800	1370
18	360	710	420	1000	680	1110	1100	2050
20	360	710	500	1000	800	1185	1100	1880
24	500	1000	650	1600	1500	2140	2000	2940

NPS (in.)	Class 900		Class 1500		Class 2500	
	Min Torque	Max Torque	Min Torque	Max Torque	Min Torque	Max Torque
0.5	70	120	70	120	50	100
0.75	70	120	70	120	70	100
1	110	190	110	190	105	160
1.25	110	190	110	190	210	245
1.5	165	290	170	290	290	355
2	110	190	110	190	185	245
2.5	165	290	170	290	255	355
3	125	200	245	355	445	500
4	240	415	400	500	700	800
5	350	585	560	800	1240	1500
6	285	455	520	680	1835	2200
8	480	795	805	1100	1700	2200
10	500	795	1480	2000	2915	4400
12	535	795	1470	2200	4295	5920
14	600	935	2120	3180		
16	895	1285	2935	4400		
18	1520	2335	3950	5920		
20	1720	2570	5150	7720		
24	2950	5135	8335	12500		

Notes:
 Torque Values are in ft.-lbs., and assume Alloy Steel Bolts (A193 B7 w/ 2H Nuts) with oil/graphite lubrication.
 (Nut factors used on these charts are within .15 to .19)
 Flexitallic does not generally recommend a bolt stress above 60,000 PSI.
 Torque values limit minimum and maximum gasket seating stresses based upon pressure class and certain operating conditions. (i.e: maximum pressure ratings for given pressure class, not hydrotest pressure). Extreme operating conditions such as high temperature may reduce bolt yield strength. Caution should be used in these applications. The above torque values are for general use only. For critical or extreme applications (high temperature/pressure) consult with Flexitallic engineering.
 Flexitallic does not accept responsibility for the misuse of this information.

Recommended Torque

Torque Table for Spiral Wound CGI - SERIES A Gaskets

NPS (in.)	Class 150		Class 300		Class 400		Class 600		Class 900	
	Min Torque	Max Torque	Min Torque	Max Torque	Min Torque	Max Torque	Min Torque	Max Torque	Min Torque	Max Torque
26	500	890	1100	1600	1500	2000	2000	2670	3950	6910
28	500	830	1100	1720	2000	2670	2200	2930	5150	9010
30	500	880	1500	2140	2200	2930	2200	2930	5150	9010
32	800	1330	2000	2670	2200	2930	3180	4240	6670	11665
34	800	1330	2000	2770	2200	2930	3180	4240	8330	14580
36	800	1330	2200	2930	2200	2930	4400	5870	8330	14580
38	800	1370	800	1260	1500	2280	3180	4240	9210	14580
40	800	1330	1100	1930	2000	2750	3180	4240	8530	14580
42	800	1460	1100	2020	2000	2880	4400	5870	9230	14580
44	800	1480	1500	2640	2200	2930	4400	5870	10730	17970
46	800	1550	2000	3600	2200	2930	4400	5870	12550	21940
48	800	1460	2000	3300	3180	4240	5920	7890	13460	21940
50	1500	2500	2200	3300	3180	4240	7720	10300		
52	1500	2500	2200	3430	3180	4240	7720	10300		
54	1500	2500	3180	4580	4400	5870	7720	10300		
56	1500	2500	3180	4740	4400	5870	10000	13300		
58	1500	2500	3180	4310	4400	5870	10000	13300		
60	1500	2500	3180	4450	5920	7890	12500	16670		

Torque Table for Spiral Wound CGI - SERIES B Gaskets

NPS (in.)	Class 150		Class 300		Class 400		Class 600		Class 900	
	Min Torque	Max Torque	Min Torque	Max Torque	Min Torque	Max Torque	Min Torque	Max Torque	Min Torque	Max Torque
26	100	200	500	830	680	910	1100	1560	3430	5140
28	100	200	500	790	800	1120	1500	2000	4230	6910
30	100	200	680	920	800	1230	2000	2670	5150	9010
32	100	200	800	1070	1100	1760	2200	2940	5750	9010
34	160	320	800	1070	1100	1520	3180	4240	7030	11670
36	160	320	1100	1470	1500	2290	3180	4240	5610	9010
38	250	490	1100	1470	1500	2280	3180	4240	9220	14590
40	260	490	1100	1470	2000	2750	3180	4240	8530	14590
42	250	490	1500	2000	2000	2880	4400	5870	9240	14590
44	250	490	1500	2000	2200	2930	4400	5870	10730	17970
46	380	710	2000	2670	2200	2930	4400	5870	12550	21940
48	360	710	2000	2670	3180	4240	5920	7900	13460	21940
50	360	710	2000	2670	3180	4240	7720	10300		
52	360	710	2000	2670	3180	4240	7720	10300		
54	360	710	2000	2670	4400	5870	7720	10300		
56	360	710	3180	4240	4400	5870	10000	13340		
58	500	880	3180	4240	4400	5870	10000	13340		
60	500	840	3180	4240	5920	7900	12500	16670		

Notes:
 Torque Values are in ft.-lbs., and assume Alloy Steel Bolts (A193 B7 w/ 2H Nuts) with oil/graphite lubrication.
 (Nut factors used on these charts are within .15 to .19)
 Flexitallic does not generally recommend a bolt stress above 60,000 PSI
 Torque values limit minimum and maximum gasket seating stresses based upon pressure class and certain operating conditions. Extreme operating conditions such as high temperature may reduce bolt yield strength. Caution should be used in these applications. The above torque values are for general use only. For critical or extreme applications (high temperature/pressure) consult with Flexitallic engineering.
 Flexitallic does not accept responsibility for the misuse of this information.

Torque Required To Produce Bolt Stress

The torque or turning effort required to produce a certain stress in bolting is dependent upon a number of conditions, some of which are:

1. Diameter of bolt
2. Type and number of threads on bolt
3. Material of bolt
4. Condition of nut bearing surfaces
5. Lubrication of bolt threads and nut bearing surfaces
6. Gasket seating stress related to bolt stress/load
7. Bolt interaction
8. Effects of gasket type

Torque Data For Use with Alloy Steel Stud Bolts

Load in Pounds on Stud Bolts When Torque Loads Are Applied

Nominal Diameter of Bolt (inches)	Number of Threads (per inch)	Diameter at Root of Thread (inches)	Area at Root of Thread sq. inch	Stress					
				30,000 psi		45,000 psi		60,000 psi	
				Torque ft./lbs.	Load lbs.	Torque ft./lbs.	Load lbs.	Torque ft./lbs.	Load lbs.
1/4	20	.185	.027	4	810	6	1215	8	1620
5/16	18	.240	.045	8	1350	12	2025	16	2700
3/8	16	.294	.068	12	2040	18	3060	24	4080
7/16	14	.345	.093	20	2790	30	4185	40	5580
1/2	13	.400	.126	30	3780	45	5670	60	7560
9/16	12	.454	.162	45	4860	68	7290	90	9720
5/8	11	.507	.202	60	6060	90	9090	120	12120
3/4	10	.620	.302	100	9060	150	13590	200	18120
7/8	9	.731	.419	160	12570	240	18855	320	25140
1	8	.838	.551	245	16530	368	24795	490	33060
1-1/8	8	.963	.728	355	21840	533	32760	710	43680
1-1/4	8	1.088	.929	500	27870	750	41805	1000	55740
1-3/8	8	1.213	1.155	680	34650	1020	51975	1360	69300
1-1/2	8	1.338	1.405	800	42150	1200	63225	1600	84300
1-5/8	8	1.463	1.680	1100	50400	1650	75600	2200	100800
1-3/4	8	1.588	1.980	1500	59400	2250	89100	3000	118800
1-7/8	8	1.713	2.304	2000	69120	3000	103680	4000	138240
2	8	1.838	2.652	2200	79560	3300	119340	4400	159120
2-1/4	8	2.088	3.423	3180	102690	4770	154035	6360	205380
2-1/2	8	2.338	4.292	4400	128760	6600	193140	8800	257520
2-3/4	8	2.588	5.259	5920	157770	8880	236655	11840	315540
3	8	2.838	6.324	7720	189720	11580	284580	15440	379440
3-1/4	8	3.088	7.490	10000	224700	15000	337050	20000	449400
3-1/2	8	3.338	8.750	12500	262500	18750	393750	25000	525000
3-3/4	8	3.589	10.11	15400	303300	23150	454950	30900	606600

Note: Torque values are based on well lubricated alloy steel bolting.

Installation

Good Preparation Ensures Good Performance

- Handle with care
- Keep in package
- Protect from damage and the weather
- Stack; don't hang
- Check flange surfaces for correct finish, blemishes, flatness, etc.
- Verify that proper stud material is being used
- Check condition of studs and nuts
- If washers are used they must be hardened
- Lubricate threads and bearing surface of nuts
- Don't apply any compounds or pastes on the gasket
- Use the correct, new gasket
- Don't secure the gasket to the flange with duct tape, if necessary use an aerosol adhesive such as 3M #77
- Use a cross bolting pattern in incremental steps; then go bolt-to-bolt
- Apply sufficient load



Flexitallic's Flange Assembly and Proper Bolting Procedures Seminar

Let the Flexitallic Engineering and Technical Sales staffs train your personnel on proper flange assembly and bolting procedures using our Demonstration Unit.

Understanding proper bolting practices and the gasket response to improper procedures is key to having **leak free joints** which allow for longer and safer uptime.

The Demonstration Unit illustrates and allows for:

- Hands-on craft skill development
- Elastic interaction of bolts (cross talk)
- Bolt scatter
- Effects of different assembly procedures
- Effects of different gasket types
- Gasket seating stress related to bolt stress and load
- Gasket response to overloading
- Inward radial buckling



Troubleshooting

Joint Leakage

When joint leakage occurs, a simple examination of the used gasket can determine the cause of failure. Firstly, always ensure that the spent gasket is correct to specification.

The Used Gasket . . . Telltale Signals for Spiral Wound Gaskets

Gasket Features	Observation	Possible Cause	Possible Remedy
Metal Windings	Asymmetrical compression and/or flattening of the lands of the chevron	Smooth and/or Dissimilar surface finish	Apply recommended surface finish 125/250 Ra. Use inner and outer rings. Place gasket in a groove
	Corrosion	Improper metal selection	Select metal compatible for the media
	Severe discoloration, cracking	Improper metal selection Exceeding temperature limit	Select proper metal
	Impingement or mechanical damage	Gasket wrongly sized Improper installation	Redesign gasket or use alternative gasket Improve installation and/or procedure
Filler	Extreme discoloration Corrosion	Filler material incompatible with media or process	Select filler material compatible with media/ process and temperature
	Oxidation	Exceed temperature limit Incompatible with media	
Thickness	Uneven compression	Flange waviness Flange out of parallel Flange rotation Improper installation and/or procedures	Machine flanges to recommended flatness and parallelism. Reduce bolt stress and/or compensate for rotational effects. Improve installation procedures
	Over-compression	Improper gasket selection Improper joint geometry	Use inner and/or outer rings Redesign joint geometry
	Insufficient compression	Improper installation Improper gasket stiffness insufficient bolt load Improper joint geometry	Improve installation Use proper constructed gasket Improve joint geometry
Gasket face surfaces	Leak path scoring	Foreign matter	Proper clean up of flanges and/or gaskets
	Transfer or imprint of flange surface finish	Improper surface finish	Assess finish and re-machine flanges to proper finish
	Micro imperfections, dings, scratches, interrupted surfaces	Foreign matter, tool marks on flanges, hardware, i.e. set screws to other implements	Re-machine and/or repair flanges. Remove any obstruction or interrupted surfaces
	Topical residue, smearing	Use of adhesives, grease compounds or tape as a means of gasket positioning or perceived performance enhancement	<i>Do Not</i> use any compounds, paste, grease or tape or any foreign substances. Note: Use of a light spray of adhesive is permissible for holding the gasket in place if needed
Mechanical Damage	Buckling of the sealing element	Omitting the use of an inner ring. Smooth flange surface finish. Bolt up inconsistencies. Extreme temperatures. Over-compression	Use inner rings. Assess surface finish. Reduce bolt loads to acceptable stresses. Use alternative gasket, i.e. Flexpro
	Excessive dishing, cupping indentations and yielding of outer ring	Excessive bolt load. Outer guide ring engaging bolts	Reduce bolt load to acceptable stresses. Concentric gasket installation

SECTION IV - Useful Technical Data

Metallic Gasket Materials

Material	Trade Name	Description	Temperature Range	Hardness Value (Brinell)	Comments
Carbon Steel	-	Commercial Quality Sheet Forged or Rolled Steel Often referred to as Soft Iron or Armco	-58 to 1000°F (-50 to 540°C)	120 max - 90 max for solid metal gaskets	For General applications only.
316	-	An 18-12 chromium/nickel austenitic stainless steel, containing approx. 2% molybdenum content for high temperature strength.	1500°F max (815°C)	160 max	Excellent corrosion resistance Subject to stress corrosion cracking and intergranular corrosion in the presence of certain media Carbide precipitation may occur above 540°C
316L	-	Variation of 316, carbon content reduced to 0.03% maximum	1500°F max (815°C)	160 max	Reduced possibilities of stress Corrosion cracking and intergranular corrosion due to reduced carbon content
304	-	An 18-8 chromium/nickel austenitic stainless steel	1000°F max (540°C)	160 max	Excellent corrosion resistance Subject to stress corrosion cracking and intergranular corrosion at elevated temperatures
304L	-	Variation of 304. Carbon content reduced to 0.03% maximum	1000°F max (540°C)	160 max	Reduced possibilities of stress. Corrosion cracking and intergranular corrosion due to reduced carbon content
317L	-	An 18-13 chromium/nickel 3% molybdenum austenitic stainless steel	1500°F max (815°C)	160 max	Reduced possibilities of stress Corrosion cracking and intergranular corrosion due to reduced carbon content
321	-	An 18-10 chromium/nickel austenitic stainless steel with a titanium addition	1600°F max (870°C)	160 max	Is subject to stress corrosion Reduced possibilities of intergranular corrosion
347	-	An 18-10 chromium/nickel austenitic stainless steel with the addition of columbium (niobium)	1600°F max (870°C)	160 max	Similar properties as 321. High temperature resistance
410	-	A 13% chrom, 0.15% carbon martensitic stainless alloy	1560°F max (850°C)	210 max	Excellent high temperature strength/corrosion properties. Excellent resistance to oxidation, nitriding and carborization
Titanium grade 2	Titanium grade 2	High Purity Titanium material	2000°F max (1095°C)	Approx 215	Excellent high temperature Corrosion resistance Outstanding in oxidizing medias
Alloy 600	Inconel 600®	A 70% nickel, 15% chromium, 8% Iron alloy steel	2000°F max (1095°C)	200 max	Excellent high temperature strength/corrosion properties Excellent resistance to oxidation Nitriding and carborization
Alloy 625	Inconel 625®	A nickel/chromium alloy with substantial additions of molybdenum & columbium (niobium)	2000°F max (1095°C)	240 max	Outstanding corrosion resistance in a wide range of acid, neutral and alkaline environments

Metallic Gasket Materials

Material	Trade Name	Description	Temperature Range	Hardness Value (Brinell)	Comments
Alloy 800	Incoloy 800®	A 32% nickel, 20% chromium, 46% iron alloy steel	2000°F max (1095°C)	200 max	Excellent high temperature resistance
Alloy 825	Incoloy 825®	A nickel, chromium, iron, molybdenum and copper alloy steel	2000°F max (1095°C)	180 max	High resistance to hot acid conditions and outstanding resistance to stress corrosion cracking.
Alloy 200	Nickel 200	Commercially pure (99.6%) wrought nickel	1200°F max (650°C)	150 max	Highly resistant to various reducing chemicals and caustic alkalis.
Alloy 400	Monel® 400	A 67% nickel/30% copper alloy steel	1500°F max (820°C)	200 max	High resistance to hydrofluoric acid.
Alloy B2	Hastelloy® B2	A nickel/molybdenum alloy steel	2000°F max (1095°C)	200 max	Excellent chemical resistance to hydrochloric acid, sulfuric, acetic and phosphoric acids.
Alloy C276	Hastelloy® C276	A nickel/chromium/molybdenum alloy steel	2000°F max (1095°C)	200 max	Excellent corrosion resistance to both oxidizing and reducing media.
Alloy 20	Carpenter 20	An iron/chromium alloy steel	1400°F max (760°C)	160 max	Specifically developed for applications requiring resistance to sulfuric acid.
Alloy X-750	Inconel® X-750	A nickel/chromium/iron alloy steel	2000°F max (1095°C)	-	Precipitation hardenable high resistance steel. See page 30.
Aluminum	-	Commercially pure wrought aluminum	800°F max (425°C)	Approx 35	Excellent ductility and workability.
Brass	-	Commercial copper/zinc alloy	500°F max (260°C)	Approx 60	General corrosion resistance.
Copper	-	Commercially pure copper	600°F max (315°C)	Approx 80	General corrosion resistance.
Alloy 2205	AL 2205	A 6% nickel, 22% chromium, 3% molybdenum stainless steel	600°F max (315°C)	290 max	Austenitic/Ferritic duplex alloy with improved resistance to stress corrosion cracking, pitting, crevice corrosion. Higher strength than most stainless steel grades.

Other materials include tantalum, zirconium, platinum, gold, and bronze.

Useful Material Data

Stainless Steel Materials - Worldwide Equivalents

USA	UK	DIN	FRANCE	ITALY	SPAIN	JAPAN	SWEDEN
AISI/SAE	BS	DIN / W.-Nr	AFNOR	UNI	UNE	JIS	SS
304	304 S 15	X5CrNi 18 9 / 1.4301	Z6CN 18.09	X5CrNi 18 10	X5CrNi 18 10	SUS 304	2332
304L	304 S 12	X2CrNi 18 9 / 1.4306	Z2CN 18.10	X2CrNi 18 11	X2CrNi 19 10	SUS 304L	2352 2333
309	309 S 24	X15CrNi Si 20 12 / 1.4828	Z15CNS 20.12	-	X15CrNiSi20 12	SUH 309	-
310	-	X15CrNi Si 25 20 / 1.4841	Z12CNS 25.20	X16CrNiSi25 20	X15CrNiSi 25 20	SUH 310	-
316	316 S 16	X5CrNiMo 18 10 / 1.4401	Z6CND 17.11	X5CrNiMo 17 12	X5CrNiMo 17 12	SUS 316	2347
316L	316 S 11 316 S 12	X2CrNiMo 18 10 / 1.4404	Z2CND 18.13	X2CrNiMo 17 12	X2CrNiMo 17 12	SUS 316L	2348
316Ti	320 S 31 320 S 17	X10CrNiMoTi 18 10 / 1.4571	Z6CNDT 17.12	X6CrNiMoTi1712	X6CrNiMoTi1712	-	2350
321	321 S 12	X10CrNiTi 18 19 / 1.4541	Z6CNT 18.10	X6CrTi 18 11	X7CrNiTi 18 11	SUS 321	2337
347	347 S 51	X10CrNiNb 18 9 / 1.4550	Z6CNNb 18.10	X6CrNiNb 18 11	X7CrNiNb 18 11	SUS 347	2338
410	410 S 21	X10Cr13 / 1.4006	Z12 C13	X12 Cr13	X12 Cr13	SUS 410	2302

Bolting Data

Yield Strength (ksi) vs Temperature

SPEC	GRADE	TEMPERATURE °F/°C							
		70/20	400/205	600/315	800/425	1000/540	1200/650	1400/760	1500/815
ASTM A193	B6	85	76	72					
	B7	75-105	65-92	60-85	53-74				
	B8-CL1*	30	21	18	17				
	B16	85-105	79-98	75-93	67-83				
ASTM A320	L7, L7A	105	92	84	73				
ASTM A453	660	85	82	81	80				
BS 4882	Nimonic B80A	90						73	
ASTM B446	Inconel 625	60							50
ASTM B637	Inconel 718	150						107	

Elastic Modulus (X 10⁶ psi) vs Temperature

SPEC	GRADE	TEMPERATURE °F/°C								
		-200/-130	70/20	400/205	600/315	800/425	1000/540	1200/650	1400/760	1500/815
ASTM A193	B6	30.7	29.2	27.3	26.1	24.7				
	B7	31.0	29.7	27.9	26.9	25.5				
	B8-CL1*	29.7	28.3	26.5	25.3	24.1				
	B16	31.0	29.7	27.9	26.9	25.5				
ASTM A320	L7	31.0	29.7	27.9	26.9	25.5				
ASTM A453	660	29.7	28.3	26.5	25.3	24.1				
BS 4882	Nimonic B80A		31.2						>22.7	
ASTM B446	Inconel 625	30.2								22.6
ASTM B637	Inconel 718	29.0							22.3	

* When using stainless steel bolting, ensure that yield strength of bolts is high enough to ensure that sufficient preload is available to properly compress the gasket, e.g. consider use of ASTM A193 B8 Class 2 rather than Class 1.

Bolting Data

Design Stress Values (ksi) vs Temperature

SPEC	GRADE	TEMPERATURE °F/°C									
		650/345	700/370	750/400	800/425	850/455	900/480	950/510	1000/540	1050/565	1100/595
ASTM A193	B6	21.2	21.2	21.2	19.6	15.6	12.0				
	B7 *	25.0	25.0	23.6	21.0	17.0	12.5	8.5	4.5		
	B7M *	20.0	20.0	20.0	18.5	16.2	12.5	8.5	4.5		
	B8-CL1**	11.2	11.0	10.8	10.5	10.3	10.1	9.9	9.7	9.5	
	B16	25.0	25.0	25.0	25.0	23.5	20.5	16.0	11.0	6.3	2.8
ASTM A320	L7	20.0	20.0	20.0	20.0	16.2	12.5	8.5	4.5		
ASTM A453	660	20.2	20.1	20.0	19.9	19.9	19.9	19.8	19.8		

* For Bolt Diameters ≤ 2-1/2"

Please note that the above values are for reference purposes only. Values are extracted from ASME or BS 5500.

Recommended Working Temperatures of Bolt Materials

MATERIAL	TEMPERATURE °F/°C	
	MIN.	MAX.
Carbon Steel	-20/-30	570/300
B7	-20/-30	750/400
L7	-150/-100	750/400
B6	-20/-30	950/510
B8	-325/-200	1075/580
B16	-20/-30	975/525
B17/660	-20/-30	1200/650
B80A	-420/-250	1400/760
Inconel 625	-420/-250	1200/650
Inconel 718	-420/-250	1400/760

Stress Retention Properties of Bolt Materials

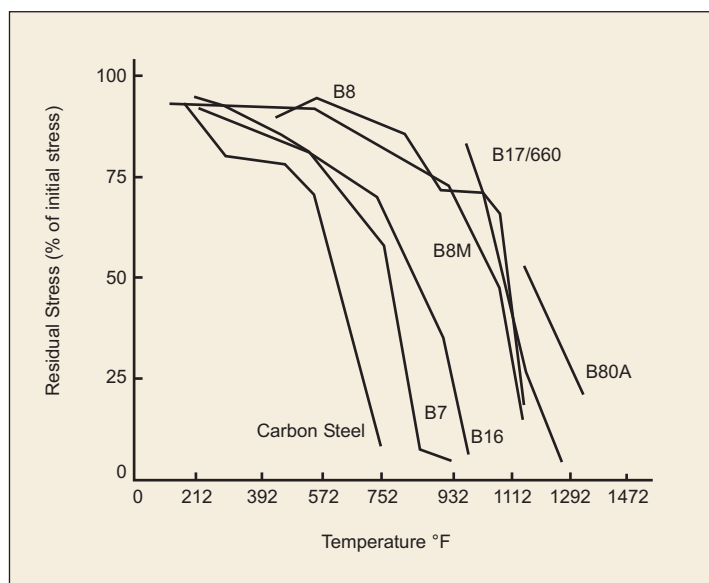

Stress relaxation behavior of various bolting materials showing percentage of initial stress retained at temperature

** When using stainless steel bolting, ensure that yield strength of bolts is high enough to ensure that sufficient preload is available to properly compress the gasket, e.g. consider use of ASTM A193 B8 Class 2 rather than Class 1.

Bolting Data

Bolting Data for ASME B16.5 & BS 1560 Flanges

NOMINAL PIPE SIZE	CLASS 150				CLASS 300				CLASS 400				CLASS 600			
	FLANGE DIA.	NO. OF BOLTS	BOLT DIA.	B.C. DIA.	FLANGE DIA.	NO. OF BOLTS	BOLT DIA.	B.C. DIA.	FLANGE DIA.	NO. OF BOLTS	BOLT DIA.	B.C. DIA.	FLANGE DIA.	NO. OF BOLTS	BOLT DIA.	B.C. DIA.
1/4	3-3/8	4	1/2	2-1/4	3-3/8	4	1/2	2-1/4	3-3/8	4	1/2	2-1/4	3-3/8	4	1/2	2-1/4
1/2	3-1/2	4	1/2	2-3/8	3-3/4	4	1/2	2-5/8	3-3/4	4	1/2	2-5/8	3-3/4	4	1/2	2-5/8
3/4	3-7/8	4	1/2	2-3/4	4-5/8	4	5/8	3-1/4	4-5/8	4	5/8	3-1/4	4-5/8	4	5/8	3-1/4
1	4-1/4	4	1/2	3-1/8	4-7/8	4	5/8	3-1/2	4-7/8	4	5/8	3-1/2	4-7/8	4	5/8	3-1/2
1-1/4	4-5/8	4	1/2	3-1/2	5-1/4	4	5/8	3-7/8	5-1/4	4	5/8	3-7/8	5-1/4	4	5/8	3-7/8
1-1/2	5	4	1/2	3-7/8	6-1/8	4	3/4	4-1/2	6-1/8	4	3/4	4-1/2	6-1/8	4	3/4	4-1/2
2	6	4	5/8	4-3/4	6-1/2	8	5/8	5	6-1/2	8	5/8	5	6-1/2	8	5/8	5
2-1/2	7	4	5/8	5-1/2	7-1/2	8	3/4	5-7/8	7-1/2	8	3/4	5-7/8	7-1/2	8	3/4	5-7/8
3	7-1/2	4	5/8	6	8-1/4	8	3/4	6-5/8	8-1/4	8	3/4	6-5/8	8-1/4	8	3/4	6-5/8
3-1/2	8-1/2	8	5/8	7	9	8	3/4	7-1/4	9	8	7/8	7-1/4	9	8	7/8	7-1/4
4	9	8	5/8	7-1/2	10	8	3/4	7-7/8	10	8	7/8	7-7/8	10-3/4	8	7/8	8-1/2
5	10	8	3/4	8-1/2	11	8	3/4	9-1/4	11	8	7/8	9-1/4	13	8	1	10-1/2
6	11	8	3/4	9-1/2	12-1/2	12	3/4	10-5/8	12-1/2	12	7/8	10-5/8	14	12	1	11-1/2
8	13-1/2	8	3/4	11-3/4	15	12	7/8	13	15	12	1	13	16-1/2	12	1-1/8	13-3/4
10	16	12	7/8	14-1/4	17-1/2	16	1	15-1/4	17-1/2	16	1-1/8	15-1/4	20	16	1-1/4	17
12	19	12	7/8	17	20-1/2	16	1-1/8	17-3/4	20-1/2	16	1-1/4	17-3/4	22	20	1-1/4	19-1/4
14	21	12	1	18-3/4	23	20	1-1/8	20-1/4	23	20	1-1/4	20-1/4	23-3/4	20	1-3/8	20-3/4
16	23-1/2	16	1	21-1/4	25-1/2	20	1-1/4	22-1/2	25-1/2	20	1-3/8	22-1/2	27	20	1-1/2	23-3/4
18	25	16	1-1/8	22-3/4	28	24	1-1/4	24-3/4	28	24	1-3/8	24-3/4	29-1/4	20	1-5/8	25-3/4
20	27-1/2	20	1-1/8	25	30-1/2	24	1-1/4	27	30-1/2	24	1-1/2	27	32	24	1-5/8	28-1/2
24	32	20	1-1/4	29-1/2	36	24	1-1/2	32	36	24	1-3/4	32	37	24	1-7/8	33

NOMINAL PIPE SIZE	CLASS 900				CLASS 1500				CLASS 2500			
	FLANGE DIA.	NO. OF BOLTS	BOLT DIA.	B.C. DIA.	FLANGE DIA.	NO. OF BOLTS	BOLT DIA.	B.C. DIA.	FLANGE DIA.	NO. OF BOLTS	BOLT DIA.	B.C. DIA.
1/2	4-3/4	4	3/4	3-1/4	4-3/4	4	3/4	3-1/4	5-1/4	4	3/4	3-1/2
3/4	5-1/8	4	3/4	3-1/2	5-1/8	4	3/4	3-1/2	5-1/2	4	3/4	3-3/4
1	5-7/8	4	7/8	4	5-7/8	4	7/8	4	6-1/4	4	7/8	4-1/4
1-1/4	6-1/4	4	7/8	4-3/8	6-1/4	4	7/8	4-3/8	7-1/4	4	1	5-1/8
1-1/2	7	4	1	4-7/8	7	4	1	4-7/8	8	4	1-1/8	5-3/4
2	8-1/2	8	7/8	6-1/2	8-1/2	8	7/8	6-1/2	9-1/4	8	1	6-3/4
2-1/2	9-5/8	8	1	7-1/2	9-5/8	8	1	7-1/2	10-1/2	8	1-1/8	7-3/4
3	9-1/2	8	7/8	7-1/2	10-1/2	8	1-1/8	8	12	8	1-1/4	9
4	11-1/2	8	1-1/8	9-1/4	12-1/4	8	1-1/4	9-1/2	14	8	1-1/2	10-3/4
5	13-3/4	8	1-1/4	11	14-3/4	8	1-1/2	11-1/2	16-1/2	8	1-3/4	12-3/4
6	15	12	1-1/8	12-1/2	15-1/2	12	1-3/8	12-1/2	19	8	2	14-1/2
8	18-1/2	12	1-3/8	15-1/2	19	12	1-5/8	15-1/2	21-3/4	12	2	17-1/4
10	21-1/2	16	1-3/8	18-1/2	23	12	1-7/8	19	26-1/2	12	2-1/2	21-1/4
12	24	20	1-3/8	21	26-1/2	16	2	22-1/2	30	12	2-3/4	24-3/8
14	25-1/4	20	1-1/2	22	29-1/2	16	2-1/4	25	-	-	-	-
16	27-3/4	20	1-5/8	24-1/4	32-1/2	16	2-1/2	27-3/4	-	-	-	-
18	31	20	1-7/8	27	36	16	2-3/4	30-1/2	-	-	-	-
20	33-3/4	20	2	29-1/2	38-3/4	16	3	32-3/4	-	-	-	-
24	41	20	2-1/2	35-1/2	46	16	3-1/2	39	-	-	-	-

Dimensions in inches

Flange Facing Dimensions

Facing Dimensions for ASME B16.5 & BS 1560 Flanges
Class 150, 300, 400, 600, 900, 1500 and 2500

Nominal Pipe Size	Outside Diameter See Note (3)			I.D. of Large & Small Tongue See Notes (3) & (5)	Outside Diameter See Note (3)			I.D. of Large & Small Groove See Note (3) See Note (5)	Height		Depth of Groove or Female
	Raised Face, Lapped, Large Male, & Large Tongues See Note (5)	Small Male See Notes (4) & (5)	Small Tongue See Note (5)		Large Female & Large Groove See Note (5)	Small Female See Note (4) See Note (5)	Small Groove See Note (5)		Raised Face Class 150 & 300	Raised Face Large & Small Male & Tongue Class 400, 600, 900 1500 & 2500	
1/2	1-3/8	23/32	1-3/8	1	1-7/16	25/32	1-7/16	15/16	1/16	1/4	3/16
3/4	1-11/16	15/16	1-11/16	1-5/16	1-3/4	1	1-3/4	1-1/4	1/16	1/4	3/16
1	2	1-3/16	1-7/8	1-1/2	2-1/16	1-1/4	1-15/16	1-7/16	1/16	1/4	3/16
1-1/4	2-1/2	1-1/2	2-1/4	1-7/8	2-9/16	1-9/16	2-5/16	1-13/16	1/16	1/4	3/16
1-1/2	2-7/8	1-3/4	2-1/2	2-1/8	2-15/16	1-13/16	2-9/16	2-1/16	1/16	1/4	3/16
2	3-5/8	2-1/4	3-1/4	2-7/8	3-11/16	2-5/16	3-5/16	2-13/16	1/16	1/4	3/16
2-1/2	4-1/8	2-11/16	3-3/4	3-3/8	4-3/16	2-3/4	3-13/16	3-5/16	1/16	1/4	3/16
3	5	3-5/16	4-5/8	4-1/4	5-1/16	3-3/8	4-11/16	4-3/16	1/16	1/4	3/16
3-1/2	5-1/2	3-13/16	5-1/8	4-3/4	5-9/16	3-7/8	5-3/16	4-11/16	1/16	1/4	3/16
4	6-3/16	4-5/16	5-11/16	5-3/16	6-1/4	4-3/8	5-3/4	5-1/8	1/16	1/4	3/16
5	7-5/16	5-3/8	6-13/16	6-5/16	7-3/8	5-7/16	6-7/8	6-1/4	1/16	1/4	3/16
6	8-1/2	6-3/8	8	7-1/2	8-9/16	6-7/16	8-1/16	7-7/16	1/16	1/4	3/16
8	10-5/8	8-3/8	10	9-3/8	10-11/16	8-7/16	10-1/16	9-5/16	1/16	1/4	3/16
10	12-3/4	10-1/2	12	11-1/4	12-13/16	10-9/16	12-1/16	11-3/16	1/16	1/4	3/16
12	15	12-1/2	14-1/4	13-1/2	15-1/16	12-9/16	14-5/16	13-7/16	1/16	1/4	3/16
14	16-1/4	13-3/4	15-1/2	14-3/4	16-5/16	13-13/16	15-9/16	14-11/16	1/16	1/4	3/16
16	18-1/2	15-3/4	17-5/8	16-3/4	18-9/16	15-13/16	17-11/16	16-11/16	1/16	1/4	3/16
18	21	17-3/4	20-1/8	19-1/4	21-1/16	17-13/16	20-3/16	19-3/16	1/16	1/4	3/16
20	23	19-3/4	22	21	23-1/16	19-13/16	22-1/16	20-15/16	1/16	1/4	3/16
24	27-1/4	23-3/4	26-1/4	25-1/4	27-5/16	23-13/16	26-5/16	25-3/16	1/16	1/4	3/16

Dimensions in inches

Notes:

(1) Regular facing for Class 150 and 300 steel flanged fittings and companion flange standards is a 1/16" raised face included in the minimum flange thickness dimensions. A 1/16" raised face may be supplied also on the Class 400, 600, 900, 1500, and 2500 flange standards, but it must be added to the minimum flange thickness.

(2) Regular facing for Class 400, 600, 900, 1500, and 2500 flange thickness dimensions.

(3) Tolerance of plus or minus 0.016", 1/64" is allowed on the inside and outside diameters of all facings.

(4) For small male and female joints care should be taken in the use of these dimensions to insure that pipe used is thick enough to permit sufficient bearing surface to prevent the crushing of the gasket. The dimensions apply particularly on lines where the joint is made on the end of the pipe. Screwed companion flanges for small male and female joints are furnished with plain face and are threaded with American Standard Locknut Thread.

(5) Gaskets for male-female and tongue-groove joints shall cover the bottom of the recess with minimum clearances taking into account the tolerances prescribed in Note 3.

Ordering FLEXITALLIC Gaskets for Special Flange Designs

In order for FLEXITALLIC to design a gasket suitable for the application, it is imperative that complete details be submitted for review. The information we require is the following:

1. Type of flange facing
2. Dimensions of the gasket seating surfaces
3. Number, size and material of bolts
4. Bolt circle diameter
5. Operating pressure & temperature (process media if known)
6. Hydrostatic test pressure
7. Initial bolt pre-stress
8. Customer preference on gasket materials

FLEXITALLIC supplies engineering data sheets at no cost on which this information may be submitted. As a gasket manufacturer, it is impossible for us to review every flange design to make certain that flange rotation and flange stresses are within allowable limits defined in the Code. We proceed on the assumption the design engineer has followed the design criteria established by the ASME Boiler Code and that the flanges are sufficiently rigid under the most severe condition to preclude the possibility the gasket could become unloaded either during operating conditions or hydrostatic test conditions. We are aware that most flange designers do not take into consideration flange rotation at test conditions prior to finalizing their design. We also, of a practical necessity, must assume the bolt material being used is adequate for all conditions including operating pressure at operating temperature and hydrostatic test pressure at ambient temperature.

The use of the optimum material for bolts is a very complex subject and we suggest reviewing currently available technical literature for guidance in the proper selection of bolting material for piping and pressure vessel applications.

GASKET ENGINEERING DATA

Company _____ Date _____
 Address _____ Order/Inquiry No. _____

SERVICE CONDITIONS	CUSTOMER PREFERENCE	FLANGE DESCRIPTION	FLANGE DIMENSIONS
Operating Pressure _____ psi	Gasket Material _____	Figure _____	A _____" T _____"
Operating Temp _____ °F	Gasket Filler _____	Welding Neck _____	B _____" No. of Bolts _____
Substance to be sealed _____	Ring Metal _____	Lap Joint _____	C _____" Size of Bolts _____
Unusual condition _____	Gasket Style _____	Slip On _____	D _____" Bolt Material _____
		Blind _____	
		Material _____	
		Threaded _____	
		Sketch (Back) _____	
		Print Attached _____	
		Surface Finish _____ rms	

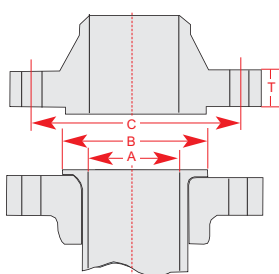

Raised Face or Van Stone

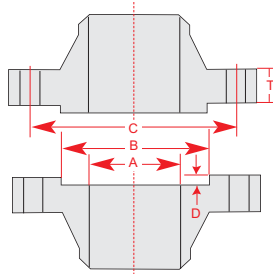

Male and Female

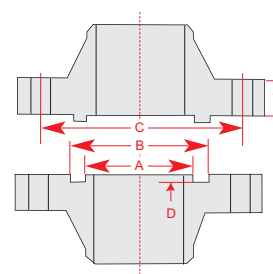

Tongue and Groove

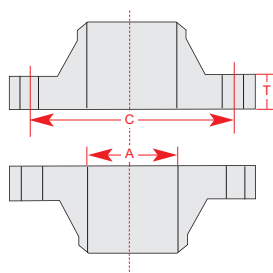

Smooth Face

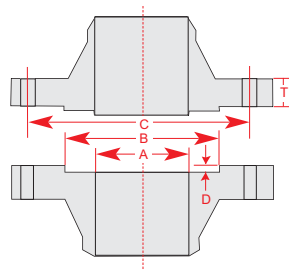

Male & Female with Spigot

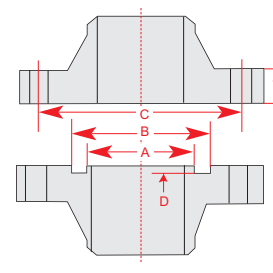

Groove to Flat Face

Ordering FLEXITALLIC Gaskets for Special Flange Designs

Overall Dimensional Limits

In general, the only limits on the dimensions of heat exchanger gaskets are the limits of sizes of material available.

Note: In addition to the above information, drawings of your application are always helpful for proper dimensioning of gaskets.

Dimensions

- Outside Diameter
- Inside Diameter
- Shape
- Style Number
- Thickness
- Material (metal or metal and filler)
- Rib width
- Distance from centerline of gasket to centerline of ribs
- Radii
- Specify number, placement, bolt circle radius and size of bolt holes

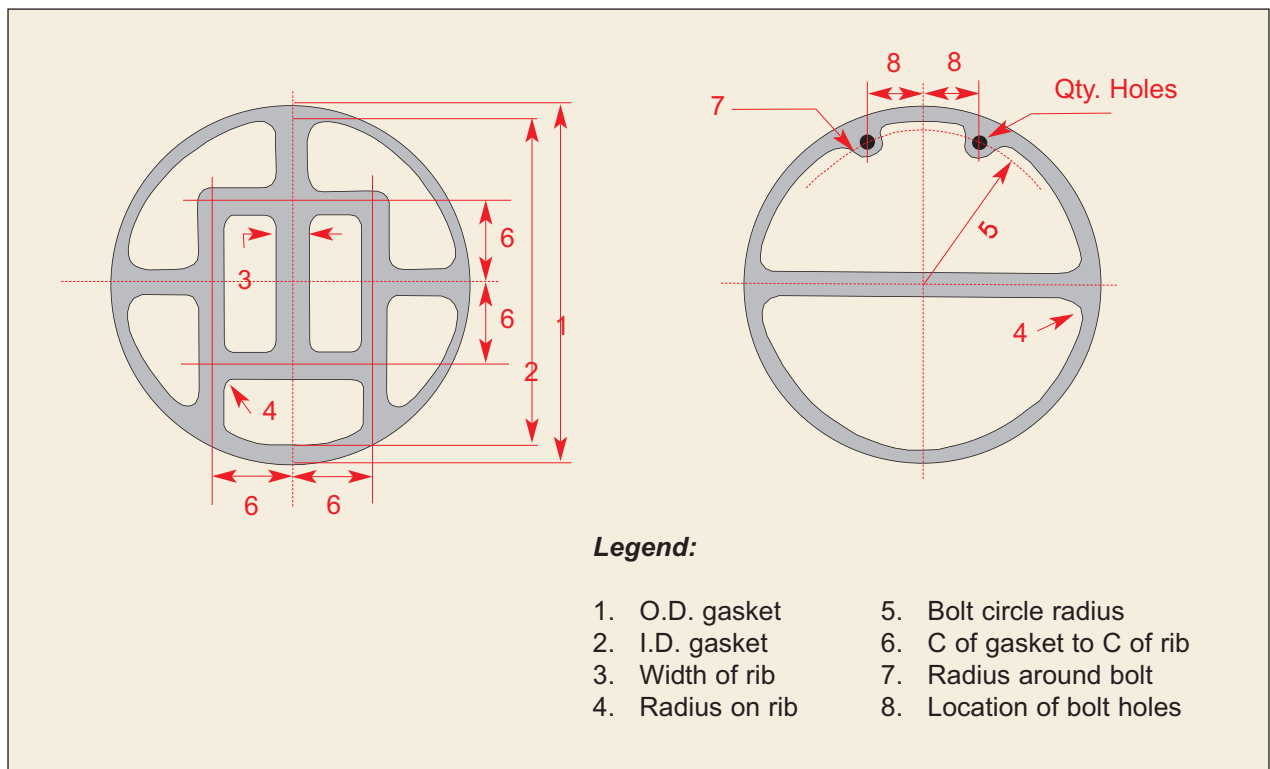

Metric Unit Conversions

To Convert From:	To SI Units:	Multiply By:
Length		
mil	mm	0.0254
in	mm	25.4
in	cm	2.54
ft	m	0.3048
Area		
in ²	cm ²	6.4516
ft ²	m ²	0.0929
Volume		
US gal	l	3.7854
US gal	m ³	0.0038

To Convert From:	To SI Units:	Multiply By:
Force		
lbf	N	4.4482
kgf	N	9.8066
Weight		
oz	g	28.3495
oz	kg	0.0283
lb	g	453.5924
lb	kg	0.4536
Density		
oz/in ³	g/cm ³	1.73
g/cm ³	kg/m ³	1000
lb/ft ³	kg/m ³	16.0185

To Convert From:	To SI Units:	Multiply By:
Pressure		
psi	Pa	6894.757
psi	kPa	6.8947
psi	bar	0.069
psi	MPa	0.0069
N/m ²	Pa	1.000
Torque		
in lb	Nm	0.113
ft lb	Nm	1.3558
Adhesion		
lb/in	KN/m	0.1751

Temperature Conversion

Conversion Formulas: $C = \frac{5}{9}(F-32)$, $F = \frac{9}{5}(C)+32$

Fahrenheit to Centigrade

-350 to 6		7 to 49		50 to 92		93 to 440		450 to 870		880 to 2000	
F	C	F	C	F	C	F	C	F	C	F	C
-350	-212	7	-13.9	50	10.0	93	33.9	450	232	880	471
-340	-207	8	-13.3	51	10.6	94	34.4	460	238	890	477
-330	-201	9	-12.8	52	11.1	95	35.0	470	243	900	482
-320	-196	10	-12.2	53	11.7	96	35.6	480	249	910	488
-310	-190	11	-11.7	54	12.2	97	36.1	490	254	920	493
-300	-184	12	-11.1	55	12.8	98	36.7	500	260	930	499
-290	-179	13	-10.6	56	13.3	99	37.2	510	266	940	504
-280	-173	14	-10.0	57	13.9	100	37.8	520	271	950	510
-273	-169	15	-9.4	58	14.4	110	43	530	277	960	516
-270	-168	16	-8.9	59	15.0	120	49	540	282	970	521
-260	-162	17	-8.3	60	15.6	130	54	550	288	980	527
-250	-157	18	-7.8	61	16.1	140	60	560	293	990	532
-240	-151	19	-7.2	62	16.7	150	66	570	299	1000	538
-230	-146	20	-6.7	63	17.2	160	71	580	304	1020	549
-220	-140	21	-6.1	64	17.8	170	77	590	310	1040	560
-210	-134	22	-5.6	65	18.3	180	82	600	316	1060	571
-200	-129	23	-5.0	66	18.9	190	88	610	321	1080	582
-190	-123	24	-4.4	67	19.4	200	93	620	327	1100	593
-180	-118	25	-3.9	68	20.0	210	99	630	332	1120	604
-170	-112	26	-3.3	69	20.6	212	100	640	338	1140	616
-160	-107	27	-2.8	70	21.1	220	104	650	343	1160	627
-150	-101	28	-2.2	71	21.7	230	110	660	349	1180	638
-140	-96	29	-1.7	72	22.2	240	116	670	354	1200	649
-130	-90	30	-1.1	73	22.8	250	121	680	360	1220	660
-120	-84	31	-0.6	74	23.3	260	127	690	366	1240	671
-110	-79	32	0.0	75	23.9	270	132	700	371	1260	682
-100	-73	33	0.6	76	24.4	280	138	710	377	1280	693
-90	-68	34	1.1	77	25.0	290	143	720	382	1300	704
-80	-62	35	1.7	78	25.5	300	149	730	388	1350	732
-70	-57	36	2.2	79	26.1	310	154	740	393	1400	760
-60	-51	37	2.8	80	26.7	320	160	750	399	1450	788
-50	-46	38	3.3	81	27.2	330	166	760	404	1500	816
-40	-40	39	3.9	82	27.8	340	171	770	410	1550	843
-30	-34	40	4.4	83	28.3	350	177	780	416	1600	871
-20	-29	41	5.0	84	28.9	360	182	790	421	1650	899
-10	-23	42	5.6	85	29.4	370	188	800	427	1700	927
0	-17.8	43	6.1	86	30.0	380	193	810	432	1750	954
1	-17.2	44	6.7	87	30.6	390	199	820	438	1800	982
2	-16.7	45	7.2	88	31.1	400	204	830	443	1850	1010
3	-16.1	46	7.8	89	31.7	410	210	840	449	1900	1038
4	-15.6	47	8.3	90	32.2	420	215	850	454	1950	1066
5	-15.0	48	8.9	91	32.8	430	221	860	460	2000	1093
6	-14.4	49	9.4	92	33.3	440	227	870	466		

The content of this Dimensional and Order Guide relates to Flexitallic's products as supplied. The information contained herein is given in good faith, but no liability will be accepted in relation to same. The revision of products, pursuant to Flexitallic's policy of continuous development, as well as the acquisition of further information, may necessitate revisions to parts or all of this document. Flexitallic's Technical Sales Department will be pleased to update customers, on request. As the company's products are used for a multiplicity of purposes, and as Flexitallic has no control over the method of their application or use, Flexitallic must exclude all conditions or warranties, express or implied, as to their products and/or their fitness for any particular purpose. Any technical cooperation between the Company and its customers is given for the customer's assistance only, and without liability on the part of Flexitallic.

Flexitallic L.P. guarantees that any product of its manufacture, which, upon examination by a Flexitallic representative, is found to be defective in either workmanship or material whereby it is suitable under proper usage and service for the purpose for which it was designed, will be replaced or repaired free of charge including transportation charges but not cost of installation or, at our option, the purchase price will be refunded. The products are not guaranteed as to performance under any specific service nor for any specific period of time. The sale of our products under any other warranty or guarantee express or implied is not authorized by the company.

WARNING:

Properties/applications shown throughout this brochure are typical. Your specific application should not be undertaken without independent study and evaluation for suitability. For specific application recommendations consult Flexitallic. Failure to select the proper sealing products could result in property damage and/or serious personal injury.

Performance data published in this brochure has been developed from field testing, customer field reports and/or in-house testing.

While the utmost care has been used in compiling this brochure, we assume no responsibility for errors. Specifications subject to change without notice. This edition cancels all previous issues. Subject to change without notice.

Flexitallic is a registered trademark for gaskets, seals and other products of Flexitallic.

breathe

IT'S SAFE



new materials that withstand the widening
extremes of temperature and pressure.
sealing **solutions** engineered
for your application. **on-site** bolting seminars
that **fight** improper installation—
a major cause of joint failure.
inhale. exhale.
you're flexitallic safe.



Flexitallic SAFE is an added level of seal integrity resulting from our commitment to innovation

in materials, co-engineered solutions and onsite education to improve installation.

Flexitallic[®]

USA / FLEXITALLIC L.P.

6915 Highway 225
Deer Park, TX 77536 USA
phone: +1-281-604-2400
fax: +1-281-604-2415

USA / CUSTOM RUBBER PRODUCTS

2625 Bennington
Houston, TX 77093 USA
phone: +1-713-691-2211
fax: +1-713-691-3005

CANADA / FLEXITALLIC

4340 - 78 Avenue
Edmonton, Alberta, T6B 3J5 Canada
phone: +1-780-466-5050
fax: +1-780-465-1177

UNITED ARAB EMIRATES / FLEXITALLIC LLC

Amenity Centre, Tower Number 2,
10th Floor, Office 4
Al Hamra Industrial Area, Ras Al Khaimah
phone: +971 (0)7 243 4305

UNITED KINGDOM / FLEXITALLIC LTD.

Scandinavia Mill
Hunsworth Lane
Cleckheaton BD19 4LN United Kingdom
phone: + 44-1274-851273
fax: +44-1274-300303

SAUDI ARABIA / FLEXITALLIC MIDDLE EAST LLC

Al-Aujam Industrial City
6790-Al Badia, Unit No. 1
Al Qatif 32656-2462
Kingdom of Saudi Arabia
phone: 0096-13-8089635

CHINA / FLEXITALLIC SEALING TECHNOLOGY CO., LTD

Building 3 South
Wujiang Export Processing Zone
688 Pangjin Road
Wujiang, Jiangsu 215200 P.R. China
phone: +86-512-6303-2839