

VHCT900 Hole Cutting Tool



WARNING 

 WARNING



Failure to follow instructions and warnings could result in death, serious personal injury, property damage, and/or product damage.

- Before operating or servicing any grooving tools, read all instructions in this manual and all warning labels on the tool.
- Wear safety glasses, hardhat, foot protection, and hearing protection while working around this tool.
- Save this operating and maintenance manual in a place accessible to all operators of the tool.

If you need additional copies of any literature, or if you have questions concerning the safe and proper operation of this tool, contact Victaulic, P.O. Box 31, Easton, PA 18044-0031, Phone: 1-800-PICK-VIC, E-Mail: pickvic@victaulic.com.

Original Instructions



TABLE OF CONTENTS

Hazard Identification 4

Operator Safety Instructions 4

Introduction 6

 Receiving The Tool6

 Container Contents6

 Returning The Tool6

Power Requirements 7

 Power Supply Requirements7

 Extension Cord Requirements7

Tool Nomenclature 8

Tool Dimensions and Specifications 9

Installing the Hole Saw10

Tool Setup10

Tool Operation14

Removing the Hole Saw16

Maintenance16

Parts Ordering Information16

Accessories17

Troubleshooting18

HAZARD IDENTIFICATION

Definitions for identifying the various hazard levels are provided below.



This safety alert symbol indicates important safety messages. When you see this symbol, be alert to the possibility of personal injury.

Carefully read and fully understand the message that follows.

DANGER

- The use of the word “DANGER” identifies an immediate hazard with a likelihood of death or serious personal injury if instructions, including recommended precautions, are not followed.

WARNING

- The use of the word “WARNING” identifies the presence of hazards or unsafe practices that could result in death or serious personal injury if instructions, including recommended precautions, are not followed.

CAUTION

- The use of the word “CAUTION” identifies possible hazards or unsafe practices that could result in personal injury and product or property damage if instructions, including recommended precautions, are not followed.

NOTICE

- The use of the word “NOTICE” identifies special instructions that are important but not related to hazards.

OPERATOR SAFETY INSTRUCTIONS

The VHCT900 tool is designed ONLY for cutting holes in steel and stainless steel pipe and copper tubing, and should ONLY be used for that purpose. These instructions must be read and understood by each operator PRIOR to working with the grooving tool. These instructions describe safe operation of the tool, including set up and maintenance. Each operator must become familiar with the tool’s operations, applications, and limitations. Particular care should be given to reading and understanding the dangers, warnings, and cautions described throughout these operating instructions.

Use of this tool requires dexterity and mechanical skills, as well as sound safety habits. Although this tool is designed and manufactured for safe, dependable operation, it is difficult to anticipate all combinations of circumstances that could result in an accident. The following instructions are recommended for safe operation of this tool. The operator is cautioned to always practice “safety first” during each phase of use, including set up and maintenance. It is the responsibility of the lessee or user of this tool to verify that all operators read this manual and fully understand the operation of this tool.

Store this manual in a clean, dry area where it is always readily available. Additional copies of this manual are available upon request through Victaulic, or can be downloaded at victaulic.com.

DANGER

1. **Avoid using the tool in potentially dangerous environments.** Do not expose the tool to rain, and do not use the tool in damp or wet locations. Do not cut holes into pressurized pipe/tubing or pipe/tubing that is filled with fluid or compressed gas. Keep the work area well lit.
2. **Ground the tool to protect the operator from electric shock.** Verify that the tool is connected to an internally grounded electrical source.

3. **Disconnect the power cord from the electrical source before servicing the tool.** Only authorized personnel should perform maintenance on the tool. Always disconnect the power cord from the electrical source before servicing or adjusting the tool.
4. **Do not operate the tool in gaseous or explosive environments.** The tool motor produces a normal spark, which could ignite fumes.

 **WARNING**

1. **Prevent back injury.** Always use proper lifting techniques when handling tool components.
2. **Wear proper apparel.** Do not wear loose clothing, gloves, jewelry, or anything that can become entangled in moving parts.
3. **Wear protective items when working with tools.** Always wear safety glasses, hardhat, foot protection, and hearing protection. A face or dust mask is recommended, since the cutting operation produces fine metal particles.
4. **Keep hands and tools away from the arbor assembly during the cutting operation.** Ensure that adjustment keys and wrenches are removed from the tool before operation.
5. **Do not reach inside pipe/tubing ends during tool operation.** Pipe edges can be sharp and can snag hands and shirt sleeves.
6. **Prevent accidental startups.** Do not carry the tool with the trigger depressed.
7. **Do not over-reach.** Maintain proper balance at all times.
8. **Do not make any modifications to the tool.** Do not remove any safety guarding or any components that affect tool performance.
9. **Do not abuse the power cord.** Never carry the tool by the power cord or yank the cord out of a receptacle. Keep the cord away from heat, oil, and sharp objects.

 **CAUTION**

1. **The VHCT900 tool is designed ONLY for grooving pipe/tubing sizes, materials, and wall thicknesses as designated.**
2. **Inspect the equipment.** Before using the tool, check moveable parts for obstructions. Ensure that tool components are installed and adjusted in accordance with setup instructions.
3. **Stay alert.** Do not operate the tool if you are drowsy from medication or fatigue.
4. **Keep visitors, trainees, and observers away from the immediate work area.** All visitors should be kept a safe distance from the equipment at all times. When using this tool on an elevated floor, the area below must remain clear of other personnel.
5. **Keep work area clean.** Keep the work area around the tool clear of any obstructions that could limit movement of the operator. Clean up any spills.
6. **Secure the tool and accessories.** Verify that the tool is stable. Refer to the “Tool Setup” section.
7. **Support the work.** Use clamps or a vise to hold work securely.
8. **Do not force the tool.** Do not force the tool or accessories to perform any functions beyond the capabilities described in these instructions. Do not overload the tool.
9. **Maintain tool with care.** Keep the tool clean to ensure proper and safe performance. Follow the instructions for lubricating tool components and changing accessories.
10. **Use only Victaulic replacement parts and accessories.** Use of any other parts may result in a voided warranty, improper operation, and hazardous situations. Refer to the “Parts Ordering Information” and “Accessories” sections.
11. **Do not remove any labels from the tool.** Replace any damaged or worn labels.

INTRODUCTION

NOTICE
<ul style="list-style-type: none"> • Drawings and/or pictures in this manual may be exaggerated for clarity. • The tool, along with this operating and maintenance instructions manual, contains trademarks, copyrights, and/or patented features that are the exclusive property of Victaulic Company.

The Victaulic VHCT900 Hole Cutting Tool is designed to cut holes in carbon steel and stainless steel pipe and copper tubing for branch connections using Victaulic Hole Cut Products. This tool is not designed for use on cast iron pipe, HDPE, or PVC plastic pipe. Never use the tool to cut anything but the intended materials. The VHCT900 is suitable for 1 ¼ – 8 inch/42.4 – 219.1 mm pipe/tubing sizes and can cut up to 4 ½ inch/114.3 mm hole sizes.

 CAUTION
<ul style="list-style-type: none"> • This tool must be used ONLY for grooving pipe/tubing with specifications that fall within the designated parameters. <p>Failure to follow this instruction could overload the tool, resulting in reduced tool life, tool damage, or personal injury.</p>

RECEIVING THE TOOL

VHCT900 Hole Cutting Tools are packed individually in sturdy containers. Upon receipt of the tool, ensure that all necessary parts are included. If any parts are missing, contact Victaulic. **NOTE:** If the tool is rented, save the container for return shipment.

CONTAINER CONTENTS

Qty.	Description
1	Drill Motor Assembly with Chuck Key
1	Base Assembly
1	U-Shaped Feed Assembly
2	Pilot Drill with Coupon Saver
1	Arbor Assembly
1	Coupon Removal Tool
2	Operating and Maintenance Instructions Manual

NOTE: Hole saws must be ordered separately. A permanent carrying case is available and can be ordered separately.

RETURNING THE TOOL

Prepare tool for shipment as received. Contact Victaulic with questions.

POWER REQUIREMENTS

DANGER

- To reduce the risk of electric shock, check the electrical source for proper grounding.
- Before performing any maintenance on the tool, disconnect the power cord from the electrical source.

Failure to follow these instructions could result in death or serious personal injury.

The VHCT900 tool is equipped with a three-prong plug and must be plugged into a grounded, single-phase electrical receptacle. Refer to Figure “A” below. If an adapter (Figure “C”) is used to accommodate the three-prong plug, the adapter’s wire must be attached to a known ground. Refer to Figures “A” and “B” and the “Power Supply Requirements” table on this page. **NEVER REMOVE THE THIRD PRONG FROM THE DRILL MOTOR’S POWER CORD PLUG.**

POWER SUPPLY REQUIREMENTS

Volts/Amps	Power Supply Requirements
115 7	115 VAC, 15-amp, 50/60 Cycle Power Supply

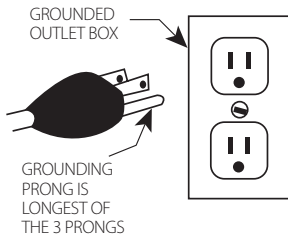

Figure A

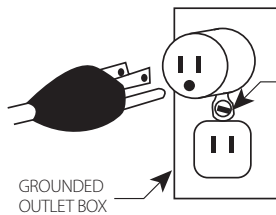

Figure B

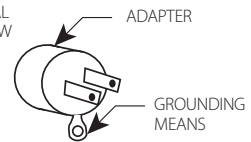

Figure C

NOTICE

- The tool is equipped with a UL Listed three-conductor cord and a three-prong, grounding-type plug to fit the proper grounding-type receptacle. The green (or green and yellow) conductor in the cord is the grounding wire. Never connect the green (or green and yellow) wire to a live terminal.

EXTENSION CORD REQUIREMENTS

When pre-wired outlets are not available and an extension cord must be used, it is important to use the proper cord size (i.e. Conductor Size American Wire Gauge). Cord size selection is based upon tool rating (amps) and cord length (feet). Use of a cord size (gauge) thinner than required will cause significant voltage drop at the power head while the tool is operating. Voltage drops may cause damage to the power head and can result in improper tool operation.

NOTE: It is acceptable to use a cord size that is thicker than required.

The required cord sizes for cord lengths up to and including 100 ft/31 m are listed in the table below. Use of extension cords longer than 100 ft/31 m must be avoided.

Circuit Rating volts/amps	Cord Lengths feet/meters		
	25 8	50 15	100 31
115 15	12 gauge	12 gauge	10 gauge

TOOL NOMENCLATURE

NOTICE

- Drawings and/or pictures in this manual may be exaggerated for clarity.
- The tool, along with this operating and maintenance instructions manual, contains trademarks, copyrights, and/or patented features that are the exclusive property of Victaulic.

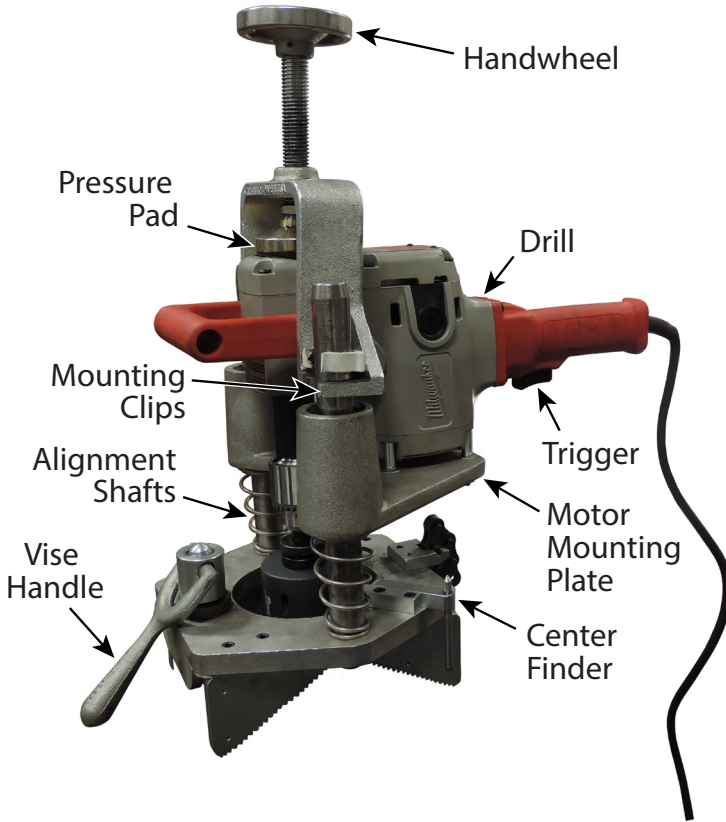

TOOL DIMENSIONS AND SPECIFICATIONS

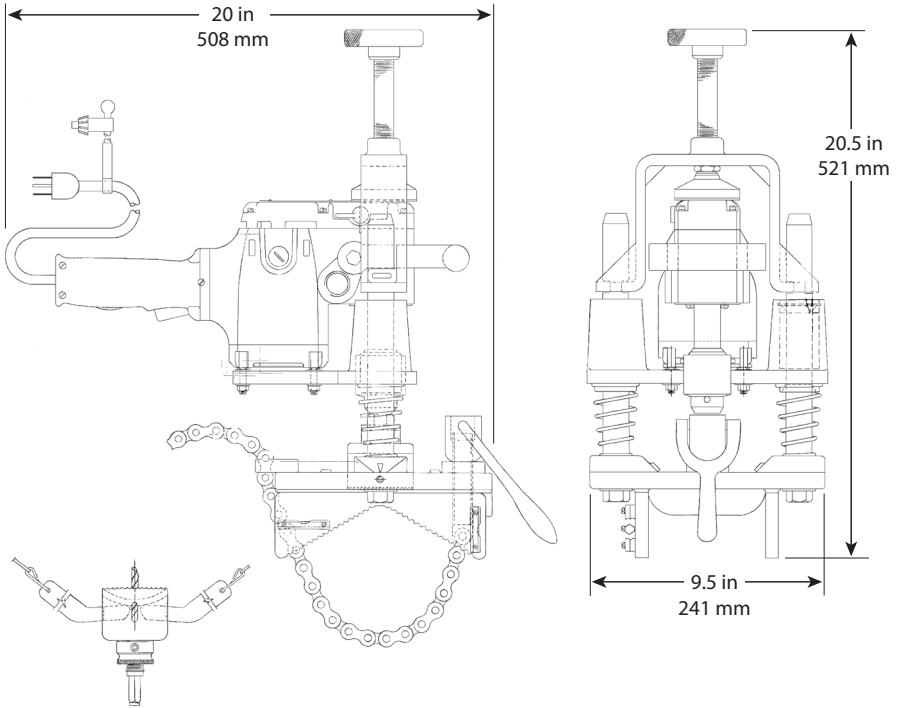

Tool weight is 40 pounds/18.1 kilograms.

Tool sound pressure is 93 dB(A). All measurements taken with a Milwaukee™ drill motor.

NOTE: Noise measurements are dependent on the drill motor, and will vary based on configuration. Always check the drill motor manufacturer's documentation for details.

™ Milwaukee is a registered trademark of Milwaukee Electric Tool Corporation

INSTALLING THE HOLE SAW

WARNING

- Refer to the individual product installation instructions to determine the appropriate hole saw size for the application.

Failure to follow this instruction will cause improper product assembly and joint failure, resulting in serious personal injury and property damage.

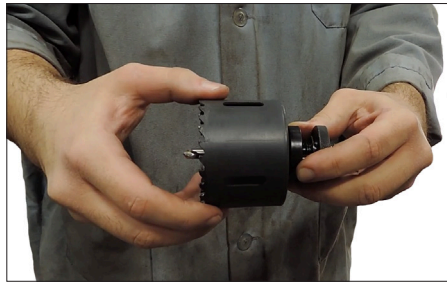

3. Firmly tighten the locking ring. If necessary, use a pliers or similar tool for tightening.



1. Align the holes in the top of the hole saw with the drive pins on the arbor assembly, then thread the hole saw onto the arbor assembly. If the pins do not line up with the holes, back off the hole saw to line up the holes with the drive pins.

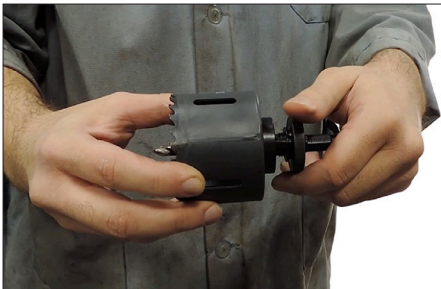

2. Thread or push the locking ring of the arbor assembly down until the pins engage the holes in the top of the hole saw.

TOOL SETUP

WARNING

- DO NOT connect the tool to the electrical source until instructed otherwise.

Accidental startup of the tool could result in serious personal injury.

NOTICE

- When selecting the hole location, take into account the width of the product being installed. Ensure that the product will not interfere with couplings or other system components. In addition, allow room on the pipe/tubing for mounting the hole cutting tool.

1. Ensure that the pipe/tubing is secured before attempting to set up the tool.



2. Locate the center of the hole to be cut on the pipe/tubing run. Mark this center point clearly with a punch.

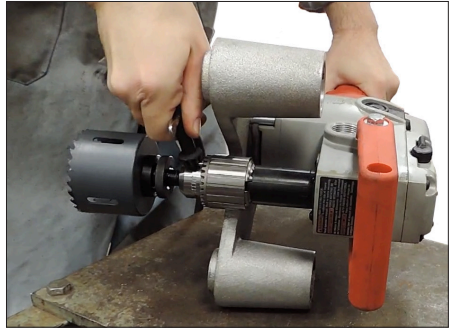

5. While supporting the arbor assembly, tighten the chuck securely with the chuck key provided. Turn the chuck manually to ensure that the arbor assembly is properly installed. If the saw assembly wobbles, loosen and remove the assembly. Repeat insertion and retighten the chuck.

3. Bubble levels are provided on the base assembly to aid in determining true 90 degrees from either axis on a horizontal pipe.



4. Insert the hex-shaped end of the arbor assembly into the chuck.

6. Remove the base from the shipping container and place it onto the pipe.



7. Hook the chain around the pipe and insert it into the slot on the side of the base. Leave the chain loose enough to allow movement. Loosen the vise handle enough to allow thread to tighten the chain around the pipe.

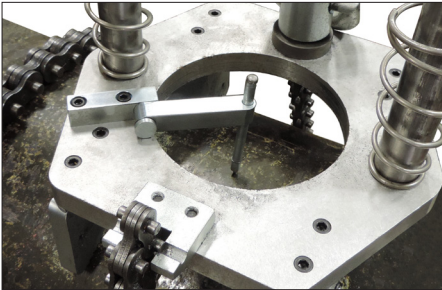

8. Flip the swing arm of the center finder so that the pointer is over the center-punched hole in the pipe. Ensure that the pointer does not make contact with the center-punched hole. If the pointer does contact the center-punched hole, hold down the center finder flush with the base plate and slide the pointer upwards until it clears the hole. Tighten the assembly. Flip the center finder back to its outermost position.

⚠ CAUTION

- The pointer **MUST** be clear of the center-punched hole before operating the tool. Failure to follow this instruction will cause serious damage to the saw and center finder, which may result in improper tool operation and personal injury.

NOTE: When operating in a vertical position, ensure that the center finder is on the bottom of the base assembly. This ensures that the center finder will not interfere with operation.

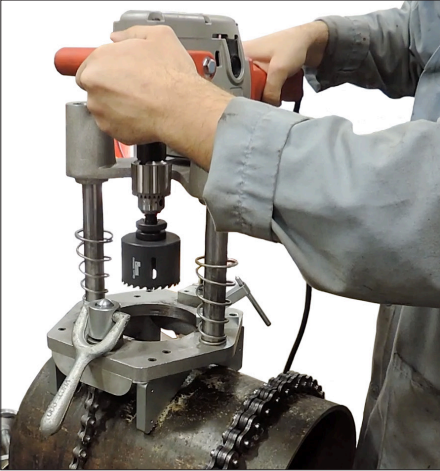

9. Mount the drill onto the alignment shafts of the base with the drill handle opposite the vise handle.

⚠ CAUTION

- When a hole is being cut on a pipe run where the alignment shafts are past the horizontal position, the drill motor must be restrained.
- Ensure that the plug cord is not wrapped around the tool or under the saw.



Failure to follow these instructions may cause serious damage to the tool, which may result in improper tool operation and personal injury.

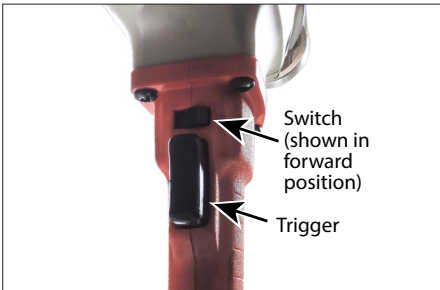

10. Place the U-shaped feed assembly onto the alignment shafts. Align the slots and push onto the spring clamps. Turn the handwheel at the top of the U-shaped feed assembly. The pressure pad will engage the motor. This will prevent the motor from disengaging when operating the tool. Always use the U-shaped feed assembly.



11. Ensure that the switch on the underside of the drill motor's handle is in the "forward" position, as shown above.
If an inline speed controller is used, ensure that it is in the "low" position.

 DANGER	
	<ul style="list-style-type: none">• To reduce the risk of electric shock, check the electrical source for proper grounding. <p>Failure to follow this instruction could result in death or serious personal injury.</p>

12. Plug the cord into an appropriate outlet or extension cord. Refer to the "Power Requirements" section.

NOTE: All operational instructions are based on the use of Milwaukee™ 4/6 Bi-Metal Hole Saws or Victaulic Hole Saws.

TOOL OPERATION

⚠ WARNING

- **NEVER** use the VHCT900 Hole Cutting Tool for applications where spark hazards exist or where contact with water can occur.

Failure to follow this instruction could result in serious personal injury.

NOTICE

- To extend hole saw life, apply thread-cutting oil to the hole during the cutting operation.



NOTE: For sizes over 2 3/4 inches, use an inline speed controller to reduce hole saw wear and improve performance.



1. Depress the trigger on the underside of the drill motor's handle. Feed the hole saw by turning the feeder knob clockwise, using a moderate rate to maintain smooth cutting action. DO NOT feed the saw too fast, which can cause the motor to stall. If difficulties occur during the cutting operation, refer to the "Troubleshooting" section.



2. After completing the cut, release the trigger completely. Retract the hole saw by turning the feeder knob counterclockwise.

⚠ WARNING



- **DO NOT** touch coupons with bare hands. Coupons can be hot and edges will be sharp.

Failure to follow this instruction could result in serious personal injury.

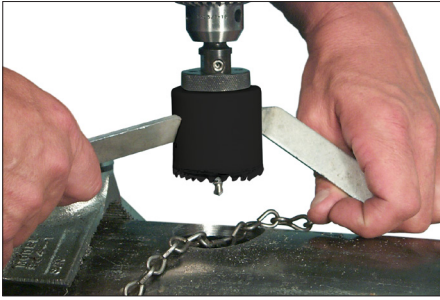

3. Unplug the tool from the electrical source. Remove the coupon from the hole saw by using the coupon removal tool, as shown above. DO NOT touch coupons with bare hands. Use caution to prevent damage to the wire that is wound into the drill. Remove any chips from the drill by using a brush. If the coupon falls into the pipe, remove it immediately.
4. Remove the tool from the pipe by removing the U-shaped feed assembly, drill, and base in reverse order from installation. Store the tool in the provided container.



- 5a. Ensure that a 5/8-inch/16-mm area around the hole is clean, smooth, and free from indentations and/or projections that could affect gasket sealing. Remove any burrs and sharp or rough edges from the hole. Burrs and sharp edges could affect product assembly, seating of the locating collar, flow from the outlet, and gasket sealing.

- 5b. The pipe/tubing around the entire circumference, within the "A" dimension shown to the right, must be free from any dirt, scale, projections, and cutting particles that could prevent the housing from seating fully on the pipe/tubing.

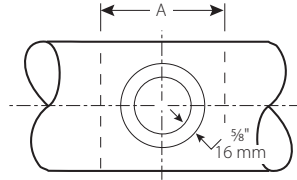

PIPE/TUBING SURFACE PREPARATION REQUIREMENTS

Size	Hole Dimensions inches/mm		Surface Preparation "A" Dimension
	Nominal Outlet Size inches Actual mm	Minimum Hole Diameter Hole Saw Size	Maximum Allowable Diameter inches mm
All 1/2-inch/ 21.3 Outlets	1 1/2 38	1 5/8 41	3 1/2 89
All 3/4-inch/ 26.9 Outlets	1 1/2 38	1 5/8 41	3 1/2 89
All 1-inch/ 33.7 Outlets	1 1/2 38	1 5/8 41	3 1/2 89
All 1 1/4-inch/ 42.4 Outlets	1 3/4 44	1 7/8 48	4 102
All 1 1/2-inch/ 48.3 Outlets	2 51	2 1/8 54	4 102
All 2-inch/ 60.3 Outlets	2 1/2 64	2 3/8 67	4 1/2 114
All 2 1/2-inch/ 73.0 Outlets	2 3/4 70	2 7/8 73	5 127
All 76.1-mm Outlets	2 3/4 70	2 7/8 73	5 1/2 140
All 3-inch/ 88.9 Outlets	3 1/2 89	3 3/8 92	5 1/2 140
All 4-inch/ 114.3 Outlets	4 1/2 114	4 3/8 118	6 1/2 165
All 108.0-mm Outlets	4 1/2 114	4 3/8 118	6 1/2 165

REMOVING THE HOLE SAW

WARNING

- Before removing the hole saw from the arbor assembly, disconnect the power cord from the electrical source.

Failure to follow these instructions could result in serious personal injury.

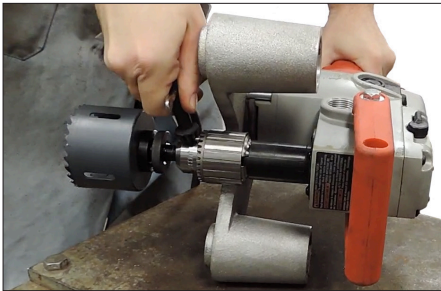

1. Using the chuck key provided, remove the arbor assembly from the drill.

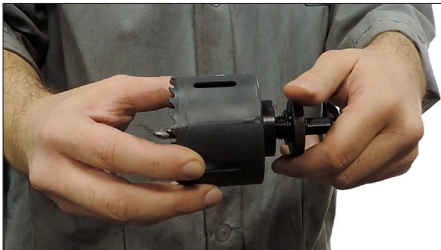

2. Loosen the locking ring, then thread or pull the locking ring all the way up.



3. Ensure that the drive pins on the arbor assembly clear the hole saw completely. Unscrew the hole saw to remove it from the arbor assembly.

MAINTENANCE

DANGER



- Before performing any maintenance on the tool, disconnect the power cord from the electrical source.

Failure to follow this instruction could result in death or serious personal injury.

This section provides information about keeping the tool in proper operating condition. Replacement parts must be ordered from Victaulic to ensure proper and safe operation of the tool.

The tool must be cleaned after drilling each piece of pipe to remove chips and debris from all components. Pay particular attention to the bit, where chips can build up and cause dulling.

Periodically lubricate the feeder rods with a light machine oil.

PARTS ORDERING INFORMATION

When ordering parts, the following information is required for Victaulic to process the order and send the correct part(s). Parts can be ordered by calling 1-800-PICK-VIC.

1. Tool Model Number
2. Tool Serial Number
3. Quantity, Item Number, Part Number, and Description
4. Where to send the part(s) – Company Name and Address
5. To whose attention to send the part(s) – Person's Name
6. Purchase Order Number
7. Billing Address

ACCESSORIES

ARBOR ASSEMBLY FOR 1-INCH DIAMETER HOLE SAW

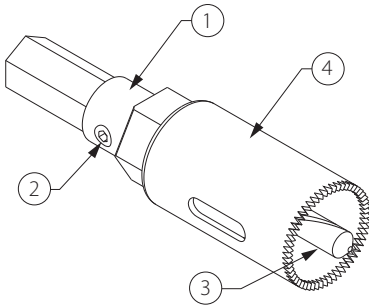

Item No.	Part No.	Qty.	Description
Ref.	R-450-900-HCT	‡	Arbor Assembly
1	N-M14-000-007	1	Arbor
2	N-S90-050-004	1	Nyloc Half Dog Set Screw
3	R-402-900-HCT	1	Coupon-Retaining Drill Bit
4	N-M18-000-011	*	1-inch/26-mm Hole Saw

‡ The arbor assembly is supplied with the tool.

* Hole saws must be ordered separately.

ARBOR ASSEMBLY FOR 1 ¼-INCH OR LARGER DIAMETER HOLE SAWS

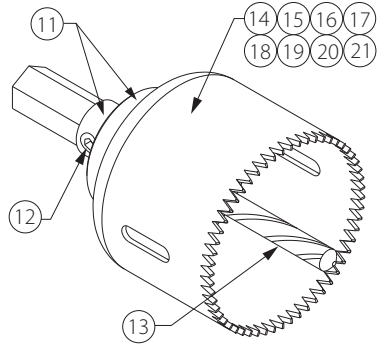

Item No.	Part No.	Qty.	Description
Ref.	R-400-900-HCT	‡	Arbor Assembly
11	N-M14-000-008	1	Arbor
12	N-S90-050-010	1	Nyloc Half Dog Set Screw
13	R-402-900-HCT	1	Coupon-Retaining Drill Bit
14	N-M18-000-016	*	1 ¼-inch/32-mm Hole Saw
15	N-M18-000-021	*	1 ½-inch/38-mm Hole Saw
16	N-M18-000-026	*	1 ¾-inch/45-mm Hole Saw
17	N-M18-000-031	*	2-inch/51-mm Hole Saw
18	N-M18-000-037	*	2 ½-inch/64-mm Hole Saw
19	N-M18-000-040	*	2 ¾-inch/70-mm Hole Saw
20	N-M18-000-047	*	3 ½-inch/89-mm Hole Saw
21	N-M18-000-050	*	4 ½-inch/114-mm Hole Saw

‡ The arbor assembly is supplied with the tool.

* Hole saws must be ordered separately.

TROUBLESHOOTING

PROBLEM	POSSIBLE CAUSE	SOLUTION
The base will not tighten onto the pipe.	The vise handle has run out of threads.	Loosen the vise handle and position one link tighter on the chain slot. Re-tighten the vise handle.
The feed assembly will not fit on the alignment shafts.	The feed handle is not fully retracted.	Fully retract the feed handle.
	The pilot drill is not fully inserted into the arbor.	Loosen the arbor set screw, fully insert the pilot drill, and tighten the arbor set screw. Ensure that the pilot drill flats are aligned with the set screw.
	The arbor is not fully inserted into the chuck.	Loosen the chuck with the chuck key, slide the arbor fully into the chuck, and tighten the chuck.
The drill motor will not operate.	The tool is not plugged into the electrical source.	Plug the tool into a proper voltage outlet or extension cord.
	The circuit breaker has tripped or a fuse has blown.	Test/reset the jobsite breaker, or replace the fuse.
	The drill motor's trigger switch is defective.	Factory service is required. Contact Victaulic.
	The power cord plug is not making contact with the receptacle.	Inspect the connection and make repairs, as necessary.
The pilot drill will not cut.	The drill motor is running in reverse.	Place the drill motor's switch in the forward position.
	The pilot drill is not tight in the arbor.	Tighten the arbor's set screw. Ensure that the arbor is engaged with the flats of the pilot drill.
	The pilot drill is dull.	Replace the pilot drill.
The hole saw blade will not cut.	The drill motor is running in reverse.	Place the drill motor's switch in the forward position.
	The drill motor is mounted on the same side of the base as the vise handle.	Slide the drill motor off of the alignment shafts, then back onto the alignment shafts on the opposite side from the vise handle.
	The hole saw blade is dull.	Replace the hole saw blade.
	One or more teeth have been broken off the hole saw blade.	Replace the hole saw blade. Inspect the cut for teeth lodged in the pipe/tubing. Remove lodged teeth with a center punch or a small chisel (wear eye protection).
	The pipe/tubing has a hard spot or a hard weld seam.	Use a sharp hole saw blade, lubricating the cut generously with thread-cutting oil. Cut the hole slowly.
	Chips are stuck in the cut.	Remove chips from the hole saw's teeth and the cut.

TROUBLESHOOTING (CONTINUED)

PROBLEM	POSSIBLE CAUSE	SOLUTION
Excessive torque is required to rotate the feeder knob.	The drill motor is running in reverse.	Place the drill motor's switch in the forward position.
	There is a lack of lubrication on the feeder rods.	Lubricate the feeder rod by following the instructions in the "Maintenance" section.
	Mechanical interference on the feeder rods.	Factory service is required. Contact Victaulic.
The drill motor gets very hot.	Holes are being cut too fast.	Feed the hole saw into the cut at a moderate rate.
	The hole saw blade is dull.	Replace the hole saw blade.
	An improper extension cord is being used (cord is either undersized or too long).	Replace the extension cord with one that is the proper size and length. Refer to the "Power Requirements" section.
The pilot drill does not retain the coupon.	The coupon-retaining drill bit is damaged.	Replace the coupon-retaining drill bit.
Hole saw rapidly wears out.	Drill is operating too fast.	Reduce drill speed using speed controller.
	There is a lack of lubrication on the hole saw blade.	Lubricate hole saw blade with thread cutting oil.

In the event of tool malfunction outside the scope of the troubleshooting section, contact Victaulic for assistance.

VHCT900 Hole Cutting Tool

UPDATED 03/2018

TM-VHCT900 11525 REV A RMOVHCT900

VICTAULIC IS A REGISTERED TRADEMARK OF VICTAULIC COMPANY AND/OR ITS AFFILIATED ENTITIES IN THE UNITED STATES AND/OR OTHER COUNTRIES.

© 2018 VICTAULIC COMPANY. ALL RIGHTS RESERVED.

