



# Brass, Composite and Thermoplastic Fittings and Valves

Catalog 3501E USA | August 2023



ENGINEERING YOUR SUCCESS.



OTSEGO, MICHIGAN



TIJUANA, MEXICO



ALBION, INDIANA



LAKEVIEW, MICHIGAN



MESA, ARIZONA

## **WARNING – USER RESPONSIBILITY**

FAILURE OR IMPROPER SELECTION OR IMPROPER USE OF THE PRODUCTS DESCRIBED HEREIN OR RELATED ITEMS CAN CAUSE DEATH, PERSONAL INJURY AND PROPERTY DAMAGE.

This document and other information from Parker-Hannifin Corporation, its subsidiaries and authorized distributors provide product or system options for further investigation by users having technical expertise.

The user, through its own analysis and testing, is solely responsible for making the final selection of the system and components and assuring that all performance, endurance, maintenance, safety and warning requirements of the application are met. The user must analyze all aspects of the application, follow applicable industry standards, and follow the information concerning the product in the current product catalog and in any other materials provided from Parker or its subsidiaries or authorized distributors.

To the extent that Parker or its subsidiaries or authorized distributors provide component or system options based upon data or specifications provided by the user, the user is responsible for determining that such data and specifications are suitable and sufficient for all applications and reasonably foreseeable uses of the components or systems.

## **Offer of Sale**

The items described in this document are hereby offered for sale by Parker Hannifin Corporation, its subsidiaries or its authorized distributors. This offer and its acceptance are governed by the provisions stated on the separate page of this document entitled "Offer of Sale".

## **Safe Drinking Water Act**

In accordance with 42 USC § 300g-6, parts in this catalog are to be used exclusively for nonpotable services such as manufacturing, industrial processing, irrigation, outdoor watering, or any other uses where the water is not anticipated to be used for human consumption. The only exceptions are parts described explicitly as "low lead" or suitable for potable water.

# Directives and Regulations

Parker complies with the directives and regulations listed below and goes beyond its statutory obligations for the ranges in question.



**D.O.T. FMVSS 571.106**  
Fittings comply with the performance requirements



**European RoHS directives: 2015/863**  
Relating to the limitation of the use of 10 hazardous substances in electrical and electronic equipment (Lead, Mercury, Cadmium, Hexavalent Chromium, PBB, PBDE, Bis Phthalate, BBP, DBP, DIBP).



Fittings meet the requirements of the specific SAE standard called out in the product sections



**CFR 21: Code of Federal Regulation Title 21: Food and Drugs**  
This code consists of lists of prohibited substances for materials intended to come into contact with foodstuffs.



**DIN 74324**  
Fittings comply with the performance requirements



**Regulation 1935/2004**  
This framework regulation relates to materials and objects designed to come into contact with foodstuffs. It describes specific measures per product group (Art. 5).



Fittings are listed under 1 of 3 categories depending on the application. Fittings meet dimensional and testing requirements as specified by Underwriter Laboratories and carry the UL symbol.



**NSF 51: NSF/ANSI-51**  
Fittings and tubes complying with this standard are tested and approved by NSF for contact with drinks and foodstuffs.



**ISO 6149-3**  
Fittings meet the dimensional requirements



**NSF 61: NSF/ANSI/CAN 61**  
Fittings and tubes complying with this standard are tested and approved by NSF for contact with drinking water.



**Gold Seal Program**  
Fittings comply with the ANSI standards and approved by WQA for contact with drinks and foodstuffs.



**NSF 42 and 58: NSF/ANSI-42/58**  
Tubes complying with this standard are tested and approved by NSF for drinking water treatment systems.



**REACH regulation: no. 1907/2006**  
As product manufacturer, we are subject to article 33 of the regulation which defines a duty to inform when a candidate substance is present at more than 0.1% weight for weight.



**WRAS: Water Regulations Advisory Scheme (UK)** Fittings approved by this programme are declared compliant for water supply by WRc - NSF.

Product	Type	Body Material	Temperature		Maximum Pressure		Tubing Size	
			MIN.	MAX.	PSI	BAR	IN.	MM

**Pneumatic**

<b>Prestolok Metal</b>	Push-to-Connect	Nickel Plated Brass	0° F (-18° C)	+200° F (+93° C)	300	21	1/8 - 1/2	4 - 12
<b>Prestolok Composite</b>	Push-to-Connect	Glass Filled Nylon	-4° F (-20° C)	+175° F (+79° C)	290	20	1/8 - 1/2	3 - 14
<b>Prestolok PLM</b>	Push-to-Connect	Nickel Plated Brass	-4° F (-20° C)	+302° F (+150° C)	435	30	5/32 - 1/2	4 - 14
<b>Prestolok PLS</b>	Push-to-Connect	Stainless Steel	-4° F (-20° C)	+302° F (+150° C)	435	30	5/32 - 1/2	4 - 12
<b>Flow controls</b>	Function	Nylon/Treated Brass	+30° F (-1° C)	+160° F (+71° C)	145	10	1/8 - 1/2	4 - 14
<b>Blocking Valves</b>	Function	Treated Brass	-4° F (-20° C)	+160° F (+71° C)	145	10	1/8 - 3/8	4 - 14
<b>Slow Start Valve</b>	Function	Nickel Plated Brass	+5° F (-15° C)	+140° F (+60° C)	150	10	1/4 - 3/8	4 - 6
<b>Threshold Sensor</b>	Function	Polymer	+5° F (-15° C)	+140° F (+60° C)	115	8	5/32	4
<b>Check Valve</b>	Function	Nylon/Nickel Plated Brass	+34° F (+1° C)	+150° F (+65° C)	145	10	5/32 - 3/8	4 - 12
<b>Slide Valves</b>								
<b>Quick Exhaust Valves</b>		Nickel-plated brass	0° F (-18° C)	+160° F (+71° C)	150	10	1/8 - 1/2	-
<b>Mini Ball Valves</b>		Nylon	-4° F (-20° C)	+175° F (+79° C)	145	10		

**Water & Beverage**

<b>LIQUIfit</b>	Push-to-Connect	Bio-based Polymer	+35° F (1° C)	+200° F (+93° C)	230	16	1/4 - 1/2	4 - 12
<b>TrueSeal Acetal</b>	Push-to-Connect	Acetal	-20° F (-29° C)	+180° F (+82° C)	300	21	1/4 - 1/2	-
<b>TrueSeal Polypropylene</b>	Push-to-Connect	Polypropylene	0° F (-18° C)	+225° F (+107° C)	150	10	1/4 - 1/2	-
<b>TrueSeal Kynar</b>	Push-to-Connect	Kynar	0° F (-18° C)	+275° F (+135° C)	300	21	1/4 - 1/2	-
<b>Fast &amp; Tite Polypropylene</b>	Compression	Polypropylene	0° F (-18° C)	+212° F (+100° C)	300	21	1/4 - 5/8	-
<b>Fast &amp; Tite Nylon</b>	Compression	Nylon	-40° F (-40° C)	+200° F (+93° C)	300	21	1/4 - 5/8	-
<b>Par-Barb Polypropylene</b>	Barb	Polypropylene	0° F (-18° C)	+212° F (+100° C)	125	9	1/8 - 3/4	-
<b>Par-Barb Nylon</b>	Barb	Nylon	-40° F (-40° C)	+200° F (+93° C)	125	9	1/8 - 1 1/2	-
<b>LIQUIfit Ball Valves</b>	Push-to-Connect	Polypropylene	+35° F (1° C)	+200° F (+93° C)	150	10	1/4 - 3/8	-
<b>TrueSeal Ball Valves</b>	Push-to-Connect	Polypropylene	0° F (-18° C)	+225° F (+107° C)	150	10	1/4 - 3/8	-
<b>Fast and Tite Ball Valves</b>	Compression	Polypropylene	+35° F (1° C)	+200° F (+93° C)	150	10	1/4 - 1/2	-
<b>Par-Barb Ball Valves</b>	Barb	Polypropylene	+35° F (1° C)	+200° F (+93° C)	150	10	1/4 - 3/8	-
<b>Check Valves</b>	Push-to-Connect	Acetal	+34° F (+1° C)	+150° F (+65° C)	150	10	1/4 - 3/8	-

**Cartridges**

<b>Carstick</b>	Push-to-Connect	Polymer	-4° F (-20° C)	+175° F (+79° C)	290	20	1/8 - 3/8	4 - 8
<b>PLM/PLS</b>	Push-to-Connect	Brass/ Stainless	-4° F (-20° C)	+175° F (+79° C)	435	30	-	4 - 14
<b>LIQUIfit</b>	Push-to-Connect	Polymer	+ 35° F (+1° C)	+200° F (+93° C)	230	16	1/4 - 1/2	4 - 12
<b>TrueSeal</b>	Push-to-Connect	Acetal	-20° F (-29° C)	+180° F (+82° C)	150	10	1/4 - 1/2	-
<b>SAE Encapsulated</b>	Push-to-Connect	Brass	-40° F (-40° C)	+200° F (+93° C)	250	17	1/4 - 5/8	-

**Transportation Push-to-Connect**

<b>PTC Brass Fittings</b>	Push-to-Connect	Brass	-40° F (-40° C)	+200° F (+93° C)	250	17	5/32 - 3/4	-
<b>PTC/PTCR Composite Fittings</b>	Push-to-Connect	Composite	-40° F (-40° C)	+200° F (+93° C)	250	17	1/4 - 3/4	-
<b>Metric Prestomatic</b>	Push-to-Connect	Brass	-40° F (-40° C)	+200° F (+93° C)	250	17	-	4 - 16
<b>Parker Safe Lock</b>			-40° F (-40° C)	+239° F (+115° C)	72	4.9		

**WARNING** These products can expose you to chemicals including NICKEL, CARBON BLACK, TITANIUM DIOXIDE, or LEAD, which are known to the state of California to cause cancer, and LEAD which is known to cause birth defects or other reproductive harm. For more information go to [www.P65Warnings.ca.gov](http://www.P65Warnings.ca.gov).

Product	Type	Body Material	Temperature		Maximum Pressure		Tubing Size	
			MIN.	MAX.	PSI	BAR	IN.	MM

**Transportation Compression**

<b>NTA</b>	Compression	Brass	-40° F (-40° C)	+200° F (+93° C)	150	10	3/16 - 3/4	-
<b>Transmission</b>	Compression	Brass	-40° F (-40° C)	+220° F (+104° C)	150	10	1/8 - 5/32	-
<b>Air Brake - AB</b>	Compression	Brass	-65° F (-54° C)	+250° F (+121° C)	400	27	1/4 - 3/4	-
<b>Air Brake Hose Ends</b>	Compression	Brass	-50° F (-45° C)	+212° F (+100° C)	225	15	3/8 - 1/2	-
<b>Vibra-Lok Buna N Sleeve</b>	Compression	Brass	-30° F (-34° C)	+275° F (+135° C)	On Condition	On Condition	1/8 - 3/4	-
<b>Vibra-Lok Fluorocarbon Sleeve</b>	Compression	Brass	-15° F (-26° C)	+450° F (+232° C)	On Condition	On Condition	1/8 - 3/4	-
<b>Truck Valves</b>	Shut Off	Brass	-30° F (-34° C)	+250° F (+121° C)	150	10	3/8 - 3/4	-
<b>Lanyard Valve</b>	Manual Release	Brass	-40° F (-40° C)	+200° F (+93° C)	150	10	-	-

**Transportation Cartridges & Manifolds**

<b>SAE Encapsulated Cartridge</b>	Push-to-Connect	Brass	-40° F (-40° C)	+200° F (+93° C)	250	17	5/32 - 3/4	-
<b>Presto Manifold</b>	Push-to-Connect	Glass Filled Nylon	-40° F (-40° C)	+200° F (+93° C)	150	10	1/4 - 1/2	-

**Industrial Compression Style**

<b>Compression</b>	Compression	Brass	-65° F (-54° C)	+250° F (+121° C)	2800	193	1/8 - 7/8	
<b>Compress-Align</b>	Compression	Brass	-65° F (-54° C)	+250° F (+121° C)	2800	193	1/8 - 1	
<b>Metric Compression</b>	Compression	Brass	-40° F (-40° C)	+482° F (+250° C)	3335	230		4 - 22
<b>Poly-Tite</b>	Compression	Brass	0° F (-18° C)	+150° F (+65° C)	150	10	1/4 - 1/2	
<b>Hi-Duty</b>	Compression	Brass	-65° F (-54° C)	+250° F (+121° C)	4300	296	1/8 - 5/8	

**Industrial Flare Fittings**

<b>45° Flare</b>	Flare	Brass	-65° F (-54° C)	+250° F (+121° C)	2800	193	1/8 - 7/8	
<b>Inverted Flare</b>	Flare	Brass	-65° F (-54° C)	+250° F (+121° C)	2800	193	1/8 - 3/4	
<b>Access Valves</b>	Flare	Brass	-20° F (-29° C)	+200° F (+93° C)	500	34	1/8 - 1/2	

**Industrial Barbed Fittings**

<b>Dubl-Barb</b>	Barbed	Brass	-65° F (-54° C)	(1/4-3/8) - +90° F (+32° C) (1/2) - +75° F (+24° C)	(1/4 - 3/8) 150 (1/2) 100	(1/4 - 3/8) 10 (1/2) 7		
<b>Hose Barbs</b>	Barbed	Brass	-40° F (-40° C)	+160° F (+71° C)	150	10	1/4 - 1	

**Industrial Adapters**

<b>Pipe</b>	Threaded	Brass	-65° F (-54° C)	+250° F (+121° C)	1,000	69	1/8 - 1	
<b>ISO Port Adapters</b>		Brass	Dependent on Tubing or Hose End Connection					
<b>Garden Hose</b>		Brass	+35° F (+2° C)	+100° F (+38° C)	75	5		

NOTE: DO NOT ALLOW MEDIA TO FREEZE OR PRODUCT DAMAGE MAY OCCUR. REFER TO USER RESPONSIBILITY ON PAGE 0.

**WARNING** These products can expose you to chemicals including NICKEL, CARBON BLACK, TITANIUM DIOXIDE, or LEAD, which are known to the state of California to cause cancer, and LEAD which is known to cause birth defects or other reproductive harm. For more information go to [www.P65Warnings.ca.gov](http://www.P65Warnings.ca.gov).



Product	Type	Body Material	Temperature		Maximum Pressure		Tubing Size	
			MIN.	MAX.	PSI	BAR	IN.	MM

**Industrial Ball Valves**

<b>500 Series</b>	Female/Female	Brass	0° F (-18° C)	+350° F (+176° C)	600	41		
<b>501 Series</b>	Female/Male	Brass	0° F (-18° C)	+350° F (+176° C)	600	41		
<b>502 Series</b>	Panel Mounted	Brass	0° F (-18° C)	+350° F (+176° C)	600	41		
<b>506 Series</b>	Straight Thread	Brass	0° F (-18° C)	+350° F (+176° C)	600	41		
<b>509 Series</b>	Solder Ends	Brass						
<b>510 Series</b>	Male/Female Straight Thread	Brass	0° F (-18° C)	+350° F (+176° C)	600	41		
<b>520 Series</b>	Female/Female	Brass	0° F (-18° C)	+350° F (+176° C)	600	41		
<b>525 Series</b>	Female/Female	Brass	-40° F (-40° C)	+350° F (+176° C)	600	41		
<b>533 Series</b>	3-Way Diversion	Brass	-20° F (-29° C)	+350° F (+176° C)	400	27		
<b>540 Series</b>	4-Way	Brass	-20° F (-29° C)	+350° F (+176° C)	400	27		
<b>590/591 Series</b>	Right Angle	Brass	-50° F (-45° C)	+350° F (+176° C)	250	17		
<b>500HB Series</b>	Hose Barb	Brass	0° F (-18° C)	+350° F (+176° C)	150	10		
<b>600 Series</b>	Six Port Diversion	Brass	0° F (-18° C)	+250° F (+121° C)	150	10		
<b>500CS/502CS Series</b>	Female/Female	Carbon Steel	-20° F (-29° C)	+425° F (+218° C)	2,000 (1/4 - 1) 1,500 (1 1/4 - 2)	137 (1/4 - 1) 103 (1 1/4 - 2)		
<b>506CS Series</b>	Straight Thread	Carbon Steel	-20° F (-29° C)	+425° F (+218° C)	3,000	206		
<b>500HP/506HP Series</b>	High Pressure	Carbon Steel	-10° F (-23° C)	+210° F (+99° C)	6,000	413		
<b>501SS</b>	Male/ Female	Stainless Steel	0° F (-18° C)	+400° F (+204° C)	2,000	137		
<b>502SS</b>	Female/Female	Stainless Steel	0° F (-18° C)	+400° F (+204° C)	2,000 (1/4 - 1) 1,500 (1 1/4 - 2)	137 (1/4 - 1) 103 (1 1/4 - 2)		
<b>708 Series</b>	Male/Female	Brass	-35° F (-37° C)	+300° F (+148° C)	500	34		
<b>709 Series</b>	Female/Female	Brass	-35° F (-37° C)	+300° F (+148° C)	500	34		
<b>200 Series</b>	Female/Female	Chrome Plated Brass	0° F (-18° C)	+200° F (+93° C)	200	13		
<b>608 Series</b>	Male/Female	Brass	0° F (-18° C)	+200° F (+93° C)	450	31		
<b>609 Series</b>	Female/Female	Brass	0° F (-18° C)	+200° F (+93° C)	450	31		
<b>Mini Ball Valves</b>		Nylon	-4° F (-20° C)	+175° F (+79° C)	145	10		

**Plug Valves**

<b>607 Series</b>	Male/Male	Brass	-40° F (-40° C)	+175° F (+79° C)	250	17		
<b>608 Series</b>	Male/Female	Brass	-40° F (-40° C)	+175° F (+79° C)	250	17		
<b>609 Series</b>	Female/Female	Brass	-40° F (-40° C)	+175° F (+79° C)	250	17		

**Needle Valves/Drain Cocks/ Ground Plug Shutoff**

<b>Needle Valves</b>	Shutoff	Brass	-45° F (-42° C)	+250° F (+121° C)	150	10		
<b>Drain Cocks</b>	External/Internal	Brass	-65° F (-54° C)	+250° F (+121° C)	150	10		
<b>Ground Plug Shutoff</b>	Shutoff	Brass	+32° F (0° C)	+125° F (+51° C)	30	2		

**WARNING** These products can expose you to chemicals including NICKEL, CARBON BLACK, TITANIUM DIOXIDE, or LEAD, which are known to the state of California to cause cancer, and LEAD which is known to cause birth defects or other reproductive harm. For more information go to [www.P65Warnings.ca.gov](http://www.P65Warnings.ca.gov).



**Darker**  
W15PLP-6-4  
MALE ELBOW

**Darker**  
W15PLP-8-8  
MALE CONNECTOR

**Darker**  
215PML-2-25  
LONG NEPPLE

**Darker**  
215PML-2-25  
LONG NEPPLE

**Darker**  
W15PW-6-4  
MALE CONNECTOR

**Darker**  
W15PW-4-2  
MALE CONNECTOR

**Darker**  
164PLP-6  
UNION TEE

**Darker**  
W172PW-4-2  
MALE BRANCH TEE

**Darker**  
63PS-4  
NUT/SLEEVE

**Darker**  
63P-6-4  
UNION

**Darker**  
63PWB-6  
UNION BULKHEAD

**Darker**  
08-4  
DUST BOOT

**Darker**  
64C-8-8  
MALE CONNECTOR

**Darker**  
64C-4-4  
MALE CONNECTOR

**Darker**  
64C-4-2  
MALE CONNECTOR

- A
- B
- C
- D
- E
- F
- G
- H
- I
- J
- K
- L
- M
- N
- O



**Pneumatic: Push-to-Connect**

Section A

Prestolok PLP Metal Push-to-Connect Fittings	Prestolok PLM Metal Push-to-Connect Fittings
Prestolok PLP Composite Push-to-Connect Fittings	Prestolok PLS Stainless Steel Push-to-Connect Fittings
Oscillating Elbows	



**Pneumatic: Integrated Fittings**

Section B

Compact Flow Controls	Stainless Steel Flow Controls	Quick Exhaust Valve
Miniature Flow Controls	In-Line Check Valves	Blocking Valves
Swivel Outlet Flow Controls	Stainless Steel Check Valves	Slow Start Valves
Plug-In Flow Controls	Piloted Operated Check Valves	Threshold Sensor Fittings
In-Line Flow Controls	Pneumatic Slide Valves	Mini Ball Valves
Metal Flow Controls		



**Water & Beverage: Thermoplastic Fittings and Valves**

Section C

LIQUIfit Fittings	Fast & Tite® Fittings	Thermoplastic Ball Valves
TrueSeal™ Fittings	Par-Barb® Fittings	



**Cartridges**

Section D

Cartridges	LIQUIfit® Cartridges	PLM/PLS Cartridges
Carstick® Cartridges	TrueSeal™ Cartridges	SAE Encapsulated Cartridges



**Transportation Push-to-Connect**

Section E

PTC/PTCR Composite Fittings	Metric Prestomatic Fittings
PTC Brass Fittings	Parker Safe Lock



**Transportation Compression Fittings & Valves**

Section F

Air Brake-NTA® Fittings	Air Brake – AB Fittings	Vibra-Lok Fittings
Transmission Fittings	Air Brake Hose Ends Fittings	Truck Valves & Lanyard Valve



**Industrial Compression Style Fittings**

Section G

Compression Fittings	Brass Metric Compression	Hi-Duty Flareless Tube Fittings
Compress-Align® Fittings	Poly-Tite Fittings	



**Industrial Flare Fittings**

Section H

45° Flare Fittings	Inverted Flare Fittings	Access Valves
--------------------	-------------------------	---------------

**WARNING** These products can expose you to chemicals including NICKEL, CARBON BLACK, TITANIUM DIOXIDE, or LEAD, which are known to the state of California to cause cancer, and LEAD which is known to cause birth defects or other reproductive harm. For more information go to [www.P65Warnings.ca.gov](http://www.P65Warnings.ca.gov).



### Industrial Barbed Fittings

Section I

Dubl-Barb® Fittings                      Hose Barb Fittings



### Industrial Adapters

Section J

Pipe Fittings                      Nickel Plated Metric Adapters                      Garden Hose Fittings  
Metric Adapters                      ISO Port Adapters



### Industrial Valves

Section K

Ball Valves Brass Series 500	Ball Valves Stainless Steel Series 501SS
Ball Valves Brass Series 501	Ball Valves Stainless Steel Series 502SS
Ball Valves Brass Series 502	Ball Valves Micro Series 708/709
Ball Valve Brass Series 506	Ball Valves Mini Series 200/608/609
Ball Valves Brass Series 509	Ball Valves Polypropylene
Ball Valves Brass Series 510	Plug Valves Series PV
Ball Valves Brass Series 520	Ball Valves Rotary Actuator Series ACT
Ball Valves Brass Series 525	Ball Valve Series BVGC
Ball Valves Brass Series 533	Ball Valve Series BVGL
3-Way Diversion / Series 540 4-Way	Ball Valve Series BVGLOCK
Ball Valves Brass Series 590/591	Ball Valve Series MBVG
Ball Valves Brass Series 500HB	Axial Valves
Ball Valves Brass Series 600	Replacement Componentry
Ball Valves Carbon Steel Series 500CS/502CS	Ball Valve Stem Extensions Series STX
Ball Valves Carbon Steel Series 506CS	Needle Valves
Ball Valves Carbon Steel Series 500HP, 506HP	Drain Cocks/Ground Plug Shutoff



### Accessories

Section L

Blow Guns                      Silencers                      Bins, Bags & Copper Tubing



### Tube Fabricating Equipment

Section M

Tube Cutters	Metric Tube Benders	Flaring Tools
Kloskut Tube Cutters	Tube Benders, Spring Type	In-Ex® Tube Deburring Tool
Tube Benders, Lever Type		



### General Technical

Section N

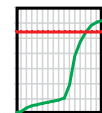

**WARNING** These products can expose you to chemicals including NICKEL, CARBON BLACK, TITANIUM DIOXIDE, or LEAD, which are known to the state of California to cause cancer, and LEAD which is known to cause birth defects or other reproductive harm. For more information go to [www.P65Warnings.ca.gov](http://www.P65Warnings.ca.gov).





# Pneumatic: Push to Connect

Prestolok PLP Metal  
Push-to-Connect Fittings

Prestolok PLP Composite  
Push-to-Connect Fittings

Oscillating Elbows

Prestolok PLM Metal  
Push-to-Connect Fittings

Prestolok PLS  
Stainless Steel  
Push-to-Connect Fittings



For more product information visit:  
[www.parker.com/automation-fittings](http://www.parker.com/automation-fittings)



A

B

C

D

E

F

G

H

I

J

K

L

M

N

O



# Prestolok PLP Metal Push-to-Connect Fittings

Prestolok PLP metal push-to-connect fittings offers a wide variety of configurations, allowing you to find the perfect product to meet your needs, optimizing the use of your equipment.

## Product Features:

- Stainless steel grab ring
- Nickel-plated brass body
- Nitrile seal
- Flame resistant release button
- Corrosion resistance
- Inch and metric tube connections
- NPT, BSPP, BSPT, and metric threads
- Meets UL94 V-0 Flame Resistance Standard

## Markets:

- Industrial
- Automotive
- Climate Control
- Welding
- Robotic Welding

## Compatible Media:

- Air
- Oil
- Inert Gases

## Specifications:

<b>Pressure Range</b>	Up to 300 PSI (20.6 bar) depending on tubing
<b>Temperature Range</b>	0° to +200° F (-17.7° to 93.3° C)
<b>Vacuum Rating</b>	28" Hg

Note: Vacuum applications are dependent upon temperature and type of tubing used  
Note: Maximum pressure and temperature range depend on the type of tubing used.

## Compatible Tubing:

- 95FR Microweld
- Polyethylene
- Polypropylene
- Semi Rigid Nylon
- Rigid Nylon
- Polyurethane 95  
Durometer Shore A

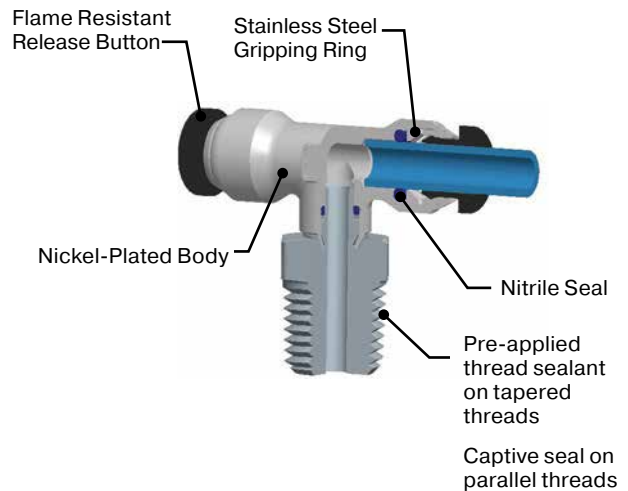

## Assembly Instructions

1. Cut tubing squarely – maximum of 15° angle allowable.
2. Check that port or mating part is clean and free of debris.
3. Mark tubing to appropriate tube insertion length. (see Tube Insertion Chart on page 15)
4. Insert tubing until it bottoms
5. Pull on tubing to verify it is fully inserted
6. To disassemble, simply press release button, hold against body and pull tubing out of fitting.

**WARNING** These products can expose you to chemicals including LEAD which is known to the state of California to cause cancer and birth defects or other reproductive harm. For more information go to [www.P65Warnings.ca.gov](http://www.P65Warnings.ca.gov).



**Threaded Fittings**

**66PLP**

Female Connector – NPTF  
p. A8



**66PLP**

Female Connector – BSPP  
p. A8



**W68PLP**

Male Connector – NPTF  
p. A9



**W68PLP**

Male Connector – BSPT  
p. A9



**68PLP**

Male Connector – BSPP  
p. A9



**68PLP**

Male Connector – BSPP  
p. A10



**68PLPR**

Round Male Connector – NPTF/UNF  
p. A10



**68PLPR**

Round Male Connector – BSPP/M5  
p. A10



**W169PLP**

Male Elbow Swivel 90° – NPTF  
p. A11



**W169PLP**

Male Elbow Swivel 90° – BSPT  
p. A12



**W169PLPNS**

Male Elbow 90° – NPTF  
p. A12



**169PLP**

Male Elbow Swivel 90° – BSPP  
p. A12



**W171PLP**

Male Run Tee Swivel – NPTF  
p. A13



**W171PLP**

Male Run Tee Swivel – BSPT  
p. A13



**171PLP**

Male Run Tee Swivel – BSPP  
p. A13



**W172PLP**

Male Branch Tee Swivel – NPTF  
p. A14



**W172PLP**

Male Branch Tee Swivel – BSPT  
p. A14



**172PLP**

Male Branch Tee Swivel – BSPP  
p. A14



**Tube to Tube Fittings**

**62PLP**

Union – Inch  
p. A7



**62PLP**

Union – Metric  
p. A7



**62PLP**

Unequal Union – Inch  
p. A7



**62PLP**

Unequal Union – Metric  
p. A7



**164PLP**

Union Tee – Inch  
p. A10



**164PLP**

Union Tee – Metric  
p. A10



**165PLP**

Union Elbow – Inch  
p. A11



**165PLP**

Union Elbow – Metric  
p. A11



**362PW**

Union Y (PVDF) – Inch  
p. A15



**362PW**

Union Y (PVDF) – Metric  
p. A15



**Bulkhead Unions**

**62PLPBH**

Bulkhead Union – Inch  
p. A7



**62PLPBH**

Bulkhead Union – Metric  
p. A7



**66PLPBH**

Female Bulkhead – NPTF  
p. A8



**66PLPBH**

Female Bulkhead – BSPP  
p. A8



**WARNING** These products can expose you to chemicals including LEAD which is known to the state of California to cause cancer and birth defects or other reproductive harm. For more information go to [www.P65Warnings.ca.gov](http://www.P65Warnings.ca.gov).



- A
- B
- C
- D
- E
- F
- G
- H
- I
- J
- K
- L
- M
- N
- O

- A
- B
- C
- D
- E
- F
- G
- H
- I
- J
- K
- L
- M
- N
- O

■ **Plug-In Fittings**

**62PLPSP**

Tube Expander –  
Inch  
p. A15



**62PLPSP**

Tube Expander –  
Metric  
p. A15



**67PLP**

Tube Reducer –  
Inch  
p. A15



**67PLP**

Tube Reducer –  
Metric  
p. A15



■ **Accessories**

**139PLP**

Plug – Metric  
p. A15



**TPL**

Plug (PVDF) – Inch  
p. A15



**DB**

Dust/Weld Spatter  
Boot  
p. A16



**3000 71 00**

Tube Cutter  
p. A16



**PTC-001**

Tube Cutter  
p. A16



**AQRT**

Quick Release  
Tool  
p. A16



**0139**

Bi-Material  
Captive Sealing  
Washer BSPP  
p. A16



**WARNING** These products can expose you to chemicals including LEAD which is known to the state of California to cause cancer and birth defects or other reproductive harm. For more information go to [www.P65Warnings.ca.gov](http://www.P65Warnings.ca.gov).



[Click here for CADs, Product Specifications or to Configure Parts Online](#)

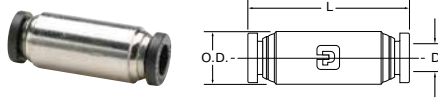

**62PLP Union – Inch**

PART NO.	TUBE SIZE IN	O.D.	L	FLOW DIA. D
62PLP-2	1/8	.375	1.40	.094
62PLP-3	3/16	.437	1.41	.156
62PLP-5/32	5/32	.375	1.41	.125
62PLP-4	1/4	.500	1.43	.188
62PLP-5	5/16	.562	1.65	.250
62PLP-6	3/8	.625	1.66	.312
62PLP-8	1/2	.750	1.82	.375

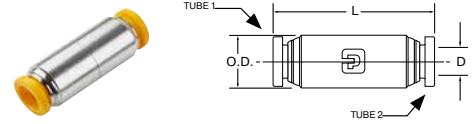

**62PLP Unequal Union – Metric**

PART NO.	TUBE 1 SIZE IN	TUBE 2 SIZE IN	O.D.	L MM	FLOW DIA. D
62PLP-4M-6M	4	6	12.70	34.94	4.17
62PLP-6M-8M	6	8	14.27	40.59	6.22
62PLP-8M-10M	8	10	17.46	41.36	10.26
62PLP-10M-12M	10	12	19.05	44.42	12.24

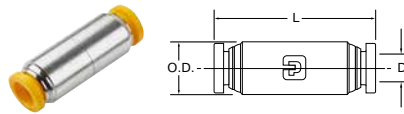

**62PLP Union – Metric**

PART NO.	TUBE SIZE MM	O.D.	L IN	FLOW DIA. D
62PLP-4M	4	9.53	35.5	3.175
62PLP-6M	6	12.70	34.4	4.775
62PLP-8M	8	14.27	41.8	6.350
62PLP-10M	10	17.46	40.9	7.925
62PLP-12M	12	19.05	40.9	9.525

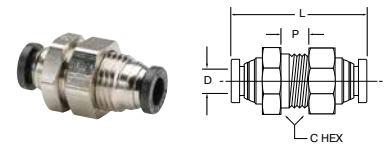

**62PLPBH Bulkhead Union – Inch**

PART NO.	TUBE SIZE IN	BULKHEAD HOLE DIA. B	C HEX	P MAX.	L	D
62PLPBH-2	1/8	7/16	9/16	.39	1.40	.094
62PLPBH-5/32	5/32	7/16	9/16	.39	1.41	.125
62PLPBH-4	1/4	9/16	11/16	.29	1.43	.188
62PLPBH-5	5/16	5/8	3/4	.60	1.65	.250
62PLPBH-6	3/8	3/4	7/8	.54	1.66	.312
62PLPBH-8	1/2	7/8	1	.66	2.04	.375

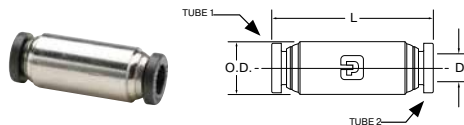

**62PLP Unequal Union – Inch**

PART NO.	TUBE 1 SIZE IN	TUBE 2 SIZE IN	O.D.	L	FLOW DIA. D
62PLP-5/32-2	5/32	1/8	.375	1.41	.094
62PLP-4-2	1/4	1/8	.500	1.43	.094
62PLP-4-5/32	1/4	5/32	.500	1.43	.125
62PLP-4-6	1/4	3/8	.625	1.66	.188
62PLP-6-8	3/8	1/2	.750	1.82	.312

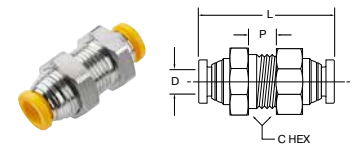

**62PLPBH Bulkhead Union – Metric**

PART NO.	TUBE SIZE MM	BULKHEAD HOLE DIA. B	C HEX	P MAX.	L MM	D MM
62PLPBH-4M	4	11	9/16	9.68	35.49	3.175
62PLPBH-6M	6	14	11/16	7.57	34.07	4.775
62PLPBH-8M	8	16	3/4	14.67	41.79	6.350
62PLPBH-10M	10	19	7/8	11.66	40.91	7.925
62PLPBH-12M	12	22	1	14.99	50.94	9.525

**WARNING** These products can expose you to chemicals including LEAD which is known to the state of California to cause cancer and birth defects or other reproductive harm. For more information go to [www.P65Warnings.ca.gov](http://www.P65Warnings.ca.gov).



- A
- B
- C
- D
- E
- F
- G
- H
- I
- J
- K
- L
- M
- N
- O

[Click here for CADs, Product Specifications or to Configure Parts Online](#)

- A
- B
- C
- D
- E
- F
- G
- H
- I
- J
- K
- L
- M
- N
- O

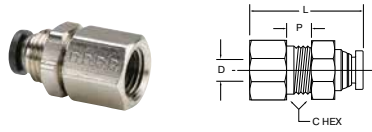

**66PLPBH Female Bulkhead – NPTF**

PART NO.	TUBE SIZE IN	PIPE THD NPTF	C HEX	P MAX.	L	FLOW DIA. D	BKHD HOLE DIA.
66PLPBH-5/32-4	5/32	1/4	11/16	.19	1.39	.125	1/2
66PLPBH-4-4	1/4	1/4	11/16	.24	1.35	.188	9/16
66PLPBH-6-6	3/8	3/8	1	.22	1.47	.312	7/8
66PLPBH-8-6	1/2	3/8	1	.35	1.56	.344	7/8

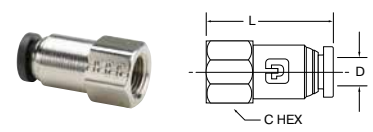

**66PLP Female Connector – NPTF**

PART NO.	TUBE SIZE IN	PIPE THREAD NPTF	C HEX	L	FLOW DIA. D
66PLP-2-2	1/8	1/8	9/16	1.17	.094
66PLP-2-4	1/8	1/4	11/16	1.34	.094
66PLP-3-2	3/16	1/8	9/16	1.13	.156
66PLP-5/32-2	5/32	1/8	9/16	1.17	.125
66PLP-5/32-4	5/32	1/4	11/16	1.38	.125
66PLP-4-2	1/4	1/8	9/16	1.17	.188
66PLP-4-4	1/4	1/4	11/16	1.38	.188
66PLP-5-2	5/16	1/8	9/16	1.25	.250
66PLP-5-4	5/16	1/4	11/16	1.45	.250
66PLP-6-4	3/8	1/4	11/16	1.46	.312
66PLP-6-6	3/8	3/8	13/16	1.51	.312

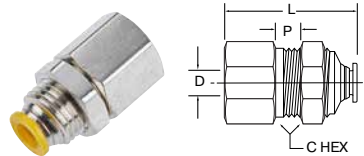

**66PLPBH Female Bulkhead – BSPP**

PART NO.	TUBE SIZE MM	THREAD BSPP	C HEX	P MAX.	L MM	FLOW DIA. D	BKHD HOLE DIA.
66PLPBH-4M-4G	4	1/4	11/16	3.81	37.85	3.175	12
66PLPBH-6M-4G	6	1/4	11/16	3.91	36.40	4.775	14
66PLPBH-10M-6G	10	3/8	1	4.93	39.50	7.925	22
66PLPBH-12M-6G	12	3/8	1	7.62	41.61	9.525	22

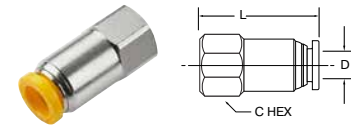

**66PLP Female Connector – BSPP**

PART NO.	TUBE SIZE MM	THREAD BSPP	C HEX	L MM	FLOW DIA. D
66PLP-4M-2G	4	1/8	9/16	30.99	3.175
66PLP-4M-4G	4	1/4	11/16	38.61	3.175
66PLP-6M-2G	6	1/8	9/16	30.05	4.775
66PLP-6M-4G	6	1/4	11/16	36.40	4.775
66PLP-8M-2G	8	1/8	9/16	33.60	6.350
66PLP-8M-4G	8	1/4	11/16	40.46	6.350
66PLP-10M-4G	10	1/4	11/16	38.23	7.925
66PLP-10M-6G	10	3/8	13/16	39.50	7.925

**WARNING** These products can expose you to chemicals including LEAD which is known to the state of California to cause cancer and birth defects or other reproductive harm. For more information go to [www.P65Warnings.ca.gov](http://www.P65Warnings.ca.gov).





[Click here for CADs, Product Specifications or to Configure Parts Online](#)

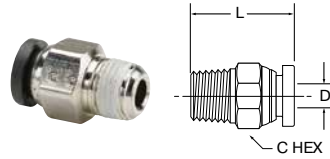

**W68PLP Male Connector – NPTF**

PART NO.	TUBE SIZE IN	PIPE THD NPTF	C HEX	L	FLOW DIA. D
68PLP-2-0**	1/8	10X32	3/8	.92	.094
W68PLP-2-1	1/8	1/16	3/8	.79	.094
W68PLP-2-2	1/8	1/8	7/16	.79	.094
W68PLP-2-4	1/8	1/4	9/16	1.02	.094
W68PLP-3-2	3/16	1/8	7/16	.85	.156
W68PLP-3-4	3/16	1/4	9/16	1.01	.156
68PLP-5/32-0**	5/32	10X32	3/8	.90	.090
W68PLP-5/32-1	5/32	1/16	3/8	.88	.940
W68PLP-5/32-2	5/32	1/8	7/16	.80	.125
W68PLP-5/32-4	5/32	1/4	9/16	1.03	.125
68PLP-4-0**	1/4	10X32	1/2	.96	.094
W68PLP-4-1	1/4	1/16	1/2	1.07	.141
W68PLP-4-2	1/4	1/8	1/2	.89	.188
W68PLP-4-4	1/4	1/4	9/16	1.00	.188
W68PLP-4-6	1/4	3/8	3/4	1.04	.188
W68PLP-5-2	5/16	1/8	9/16	1.18	.250
W68PLP-5-4	5/16	1/4	9/16	1.04	.250
W68PLP-5-6	5/16	3/8	11/16	1.04	.250
W68PLP-6-2	3/8	1/8	5/8	1.21	.250
W68PLP-6-4	3/8	1/4	5/8	1.08	.312
W68PLP-6-6	3/8	3/8	11/16	1.02	.312
W68PLP-6-8	3/8	1/2	7/8	1.28	.312
W68PLP-8-4	1/2	1/4	13/16	1.44	.344
W68PLP-8-6	1/2	3/8	13/16	1.24	.344
W68PLP-8-8	1/2	1/2	7/8	1.35	.375
68PLP-5/32-4LT*	5/32	1/4-28	7/16	.88	.093

\* SAE-LTThreads  
 \*\* Neoprene Seal

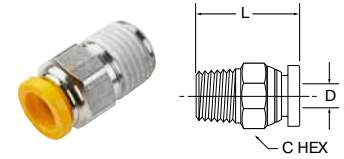

**W68PLP Male Connector – BSPT**

PART NO.	TUBE SIZE MM	THREAD BSPT	C HEX	L MM	FLOW DIA. D
W68PLP-4M-2R	4	1/8	7/16	20.41	3.175
W68PLP-4M-4R	4	1/4	9/16	27.18	3.175
W68PLP-6M-2R	6	1/8	1/2	22.00	4.775
W68PLP-6M-4R	6	1/4	9/16	26.74	4.775
W68PLP-6M-6R	6	3/8	11/16	26.46	4.775
W68PLP-8M-2R	8	1/8	9/16	29.80	6.350
W68PLP-8M-4R	8	1/4	9/16	26.24	6.350
W68PLP-8M-6R	8	3/8	11/16	27.51	6.350
W68PLP-10M-4R	10	1/4	5/8	29.72	7.925
W68PLP-10M-6R	10	3/8	11/16	27.18	7.925
W68PLP-10M-8R	10	1/2	7/8	34.24	7.925
W68PLP-12M-4R	12	1/4	13/16	36.90	8.738
W68PLP-12M-6R	12	3/8	13/16	30.85	9.525
W68PLP-12M-8R	12	1/2	7/8	33.85	9.525

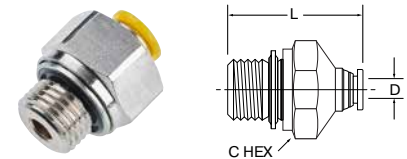

**68PLP Male Connector – BSPP**

PART NO.	TUBE SIZE MM	THREAD BSPP	C HEX	L MM	FLOW DIA. D
68PLP-4M-M5	4	M5X0.8	3/8	21.15	2.693
68PLP-4M-2G	4	1/8	9/16	23.22	3.175
68PLP-4M-4G	4	1/4	3/4	29.32	3.175
68PLP-6M-M5*	6	M5X0.8	1/2	23.39	2.80
68PLP-6M-2G	6	1/8	9/16	22.00	4.775
68PLP-6M-4G	6	1/4	3/4	28.10	4.775
68PLP-6M-6G	6	3/8	7/8	31.90	4.775
68PLP-8M-2G	8	1/8	9/16	29.67	6.350
68PLP-8M-4G	8	1/4	3/4	30.05	6.350
68PLP-8M-6G	8	3/8	7/8	35.14	6.350
68PLP-10M-4G	10	1/4	3/4	31.88	7.925
68PLP-10M-6G	10	3/8	7/8	26.80	7.925
68PLP-10M-8G	10	1/2	1 1/16	31.88	7.925
68PLP-12M-4G	12	1/4	13/16	35.76	8.738
68PLP-12M-6G	12	3/8	7/8	33.22	9.525
68PLP-12M-8G	12	1/2	1 1/16	33.47	9.525

\*M5 seal is neoprene

**WARNING** These products can expose you to chemicals including LEAD which is known to the state of California to cause cancer and birth defects or other reproductive harm. For more information go to [www.P65Warnings.ca.gov](http://www.P65Warnings.ca.gov).



[Click here for CADs, Product Specifications or to Configure Parts Online](#)

- A
- B
- C
- D
- E
- F
- G
- H
- I
- J
- K
- L
- M
- N
- O

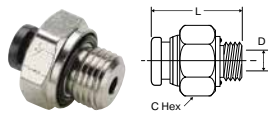

### 68PLP Male Connector – BSPP

PART NO.	TUBE SIZE IN	PIPE THD BSPP	C HEX	L	FLOW DIA. D
68PLP-4-2G	1/4	1/8	11/16	.95	.188
68PLP-4-4G	1/4	1/4	3/4	.86	.188
68PLP-4-6G	1/4	3/8	7/8	.85	.188
68PLP-6-4G	3/8	1/4	3/4	1.16	.31
68PLP-6-6G	3/8	3/8	3/4	.89	.31
68PLP-6-8G	3/8	1/2	7/8	.96	.31
68PLP-8-6G	1/2	3/8	7/8	1.22	.45
68PLP-8-8G	1/2	1/2	1-1/16	1.00	.45

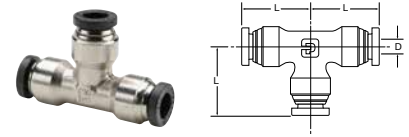

### 164PLP Union Tee – Inch

PART NO.	TUBE SIZE IN	L	FLOW DIA. D
164PLP-2	1/8	.74	.094
164PLP-3	3/16	.82	.156
164PLP-5/32	5/32	.77	.125
164PLP-4	1/4	.85	.188
164PLP-5	5/16	.97	.250
164PLP-6	3/8	1.01	.250
164PLP-8	1/2	1.15	.375

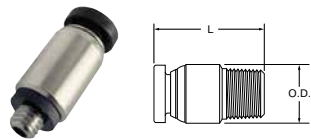

### 68PLPR Round Male Connector – NPTF/UNF

PART NO.	TUBE SIZE IN	THREAD SIZE NPTF	INTERNAL HEX BROACH	BODY DIA. O.D.	L	FLOW DIA.
68PLPR-2-0*	1/8	10-32	3/32	3/8"	.89	.094
68PLPR-5/32-0*	5/32	10-32	3/32	3/8"	.91	.094
68PLPR-4-0*	1/4	10-32	3/32	1/2"	.95	.094
W68PLPR-5/32-1	5/32	1/16	1/8	3/8"	.87	.125
W68PLPR-5/32-2	5/32	1/8	1/8	7/16"	.79	.125
W68PLPR-4-1	1/4	1/16	5/32	1/2"	1.06	.156
W68PLPR-4-2	1/4	1/8	3/16	1/2"	.88	.188
W68PLPR-4-4	1/4	1/4	3/16	5/8"	.99	.188

\*10-32 seal is neoprene

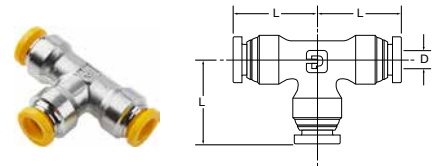

### 164PLP Union Tee – Metric

PART NO.	TUBE SIZE MM	L MM	FLOW DIA. D
164PLP-4M	4	19.40	3.175
164PLP-6M	6	20.47	4.775
164PLP-8M	8	24.58	6.350
164PLP-10M	10	24.90	7.137
164PLP-12M	12	28.77	9.525

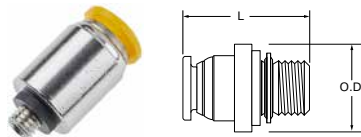

### Round Male Connector – BSPP/M5

PART NO.	TUBE SIZE MM	THREAD BSPP/M5	INTERNAL HEX BROACH	BODY DIA. O.D.	L MM	FLOW DIA.
68PLPR-4M-M5	4	M5X0.8	2.43	10.74	23.13	2.801
68PLPR-4M-2G	4	1/8	3.07	10.74	23.10	3.549
68PLPR-6M-M5*	6	M5X0.8	2.46	11.94	23.91	2.801
68PLPR-6M-2G	6	1/8	4.85	11.94	22.13	5.602
68PLPR-6M-4G	6	1/4	4.85	11.94	26.95	5.602

\*M5 seal is neoprene

**WARNING** These products can expose you to chemicals including LEAD which is known to the state of California to cause cancer and birth defects or other reproductive harm. For more information go to [www.P65Warnings.ca.gov](http://www.P65Warnings.ca.gov).

[Click here for CADs, Product Specifications or to Configure Parts Online](#)

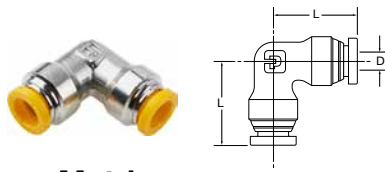

**165PLP Union Elbow – Metric**

PART NO.	TUBE SIZE MM	L MM	FLOW DIA. D
165PLP-4M	4	19.05	3.175
165PLP-6M	6	20.14	4.775
165PLP-8M	8	24.21	6.350
165PLP-10M	10	23.75	7.925
165PLP-12M	12	27.13	9.525

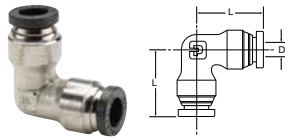

**W169PLP Male Elbow Swivel 90° – NPTF**

PART NO.	TUBE SIZE IN	PIPE THREAD NPTF	C HEX	L	N	FLOW DIA. D
W169PLP-2-1	1/8	1/16	3/8	.74	.93	.160
W169PLP-2-2	1/8	1/8	7/16	.74	.92	.094
169PLP-2-0*	1/8	10-32	3/8	.74	.74	.080
W169PLP-2-4	1/8	1/4	9/16	.74	1.10	.094
W169PLP-3-2	3/16	1/8	7/16	.82	.92	.156
W169PLP-5/32-1	5/32	1/16	3/8	.84	.93	.160
W169PLP-5/32-2	5/32	1/8	7/16	.77	.92	.125
W169PLP-5/32-4	5/32	1/4	9/16	.77	1.10	.125
169PLP-5/32-0*	5/32	10-32	3/8	.85	.74	.080
W169PLP-4-1	1/4	1/16	3/8	.84	.93	.160
W169PLP-4-2	1/4	1/8	7/16	.85	.92	.156
W169PLP-4-4	1/4	1/4	9/16	.85	1.10	.156
W169PLP-4-6	1/4	3/8	11/16	.85	1.19	.156
169PLP-4-0*	1/4	10-32	3/8	.85	.74	.080
W169PLP-5-2	5/16	1/8	9/16	.97	1.02	.250
W169PLP-5-4	5/16	1/4	9/16	.97	1.24	.250
W169PLP-6-2	3/8	1/8	9/16	1.01	1.02	.250
W169PLP-6-4	3/8	1/4	9/16	1.01	1.24	.250
W169PLP-6-6	3/8	3/8	11/16	1.01	1.24	.250
W169PLP-6-8	3/8	1/2	7/8	1.01	1.48	.250
W169PLP-8-4	1/2	1/4	9/16	1.15	1.28	.312
W169PLP-8-6	1/2	3/8	11/16	1.15	1.31	.312
W169PLP-8-8	1/2	1/2	7/8	1.15	1.52	.312

\*10-32 seal is neoprene

**165PLP Union Elbow – Inch**

PART NO.	TUBE SIZE IN	L	FLOW DIA. D
165PLP-2	1/8	.74	.094
165PLP-5/32	5/32	.77	.125
165PLP-4	1/4	.85	.188
165PLP-5	5/16	.97	.250
165PLP-6	3/8	1.01	.312
165PLP-8	1/2	1.15	.375

**WARNING** These products can expose you to chemicals including LEAD which is known to the state of California to cause cancer and birth defects or other reproductive harm. For more information go to [www.P65Warnings.ca.gov](http://www.P65Warnings.ca.gov).



Click here for CADs, Product Specifications or to Configure Parts Online

- A
- B
- C
- D
- E
- F
- G
- H
- I
- J
- K
- L
- M
- N
- O

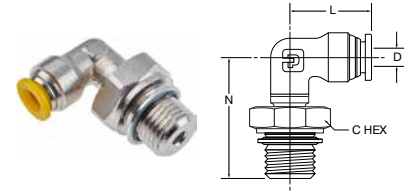
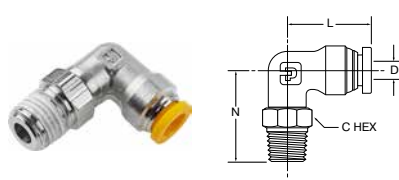

**W169PLP Male Elbow Swivel 90° – BSPT**

PART NO.	TUBE SIZE MM	THREAD BSPT	C HEX	L MM	N MM	FLOW DIA. D
W169PLP-4M-2R	4	1/8	7/16	19.05	23.93	3.175
W169PLP-4M-4R	4	1/4	9/16	19.05	28.50	3.962
W169PLP-6M-2R	6	1/8	7/16	19.13	22.91	3.962
W169PLP-6M-4R	6	1/4	9/16	19.13	27.48	3.962
W169PLP-6M-6R	6	3/8	11/16	19.13	29.74	3.962
W169PLP-8M-2R	8	1/8	9/16	24.20	26.16	6.350
W169PLP-8M-4R	8	1/4	9/16	24.20	31.75	6.350
W169PLP-8M-6R	8	3/8	9/16	24.20	31.75	6.350
W169PLP-10M-4R	10	1/4	9/16	23.75	31.49	6.350
W169PLP-10M-6R	20	3/8	11/16	23.75	31.75	6.350
W169PLP-10M-8R	10	1/2	7/8	23.75	37.69	6.350
W169PLP-12M-4R	12	1/4	11/16	27.63	32.86	7.950
W169PLP-12M-6R	12	3/8	11/16	27.63	33.78	9.525
W169PLP-12M-8R	12	1/2	7/8	27.63	38.96	9.525

**169PLP Male Elbow Swivel 90° – BSPP**

PART NO.	TUBE SIZE MM	THREAD BSPP	C HEX	L MM	N MM	FLOW DIA. D
169PLP-4M-M5	4	M5X0.8	3/8	19.05	19.79	2.425
169PLP-4M-2G	4	1/8	9/16	19.05	23.92	3.175
169PLP-4M-4G	4	1/4	3/4	19.05	30.27	3.175
169PLP-6M-M5*	6	M5X0.8	3/8	19.12	18.52	2.425
169PLP-6M-2G	6	1/8	9/16	19.12	22.94	3.960
169PLP-6M-4G	6	1/4	3/4	19.12	29.23	3.960
169PLP-6M-6G	6	3/8	11/16	19.12	31.04	2.425
169PLP-8M-2G	8	1/8	9/16	24.25	27.13	6.350
169PLP-8M-4G	8	1/4	3/4	24.20	33.25	6.350
169PLP-8M-6G	8	3/8	11/16	24.25	33.22	6.350
169PLP-10M-4G	10	1/4	3/4	23.75	32.77	6.350
169PLP-10M-6G	10	3/8	11/16	23.75	32.61	6.350
169PLP-10M-8G	10	1/2	1 1/16	23.75	37.59	6.350
169PLP-12M-4G	12	1/4	3/4	26.63	35.20	7.950
169PLP-12M-6G	12	3/8	7/8	26.63	53.20	9.525
169PLP-12M-8G	12	1/2	1 1/16	26.63	38.96	9.525

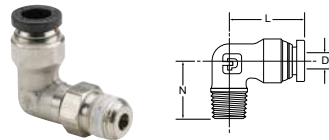

\*M5 seal is neoprene

**W169PLPNS Male Elbow 90° – NPTF**

PART NO.	TUBE IN	PIPE THD NPTF	L	N	FLOW DIA. D
W169PLPNS-2-2	1/8	1/8	.74	.67	.094
W169PLPNS5/32-2	5/32	1/8	.77	.67	.125
W169PLPNS5/32-4	5/32	1/4	.77	.87	.125
W169PLPNS-4-2	1/4	1/8	.85	.67	.188
W169PLPNS-4-4	1/4	1/4	.85	.87	.188
W169PLPNS-5-2	5/16	1/8	.97	.75	.234
W169PLPNS-5-4	5/16	1/4	.97	.94	.250
W169PLPNS-6-4	3/8	1/4	1.01	.94	.312
W169PLPNS-6-6	3/8	3/8	1.01	1.01	.312
W169PLPNS-6-8	3/8	1/2	1.01	1.27	.312
W169PLPNS-8-6	1/2	3/8	1.15	1.00	.375
W169PLPNS-8-8	1/2	1/2	1.15	1.27	.375
169PLPNS-5/32-4LT	5/32	1/4-28	.60	.48	.090

\* SAE-LT Threads

**WARNING** These products can expose you to chemicals including LEAD which is known to the state of California to cause cancer and birth defects or other reproductive harm. For more information go to [www.P65Warnings.ca.gov](http://www.P65Warnings.ca.gov).



[Click here for CADs, Product Specifications or to Configure Parts Online](#)

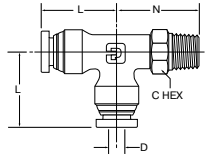

**W171PLP Male Run Tee Swivel – NPTF**

PART NO.	TUBE SIZE IN	PIPE THREAD NPTF	C HEX	L	N	FLOW DIA. D
W171PLP-2-2	1/8	1/8	7/16	.74	.92	.094
W171PLP-5/32-2	5/32	1/8	7/16	.77	.92	.125
W171PLP-4-2	1/4	1/8	7/16	.85	.92	.156
W171PLP-4-4	1/4	1/4	9/16	.85	1.10	.156
W171PLP-4-6	1/4	3/8	11/16	.85	1.24	.156
W171PLP-5-2	5/16	1/8	9/16	.97	1.02	.250
W171PLP-5-4	5/16	1/4	9/16	.97	1.24	.250
W171PLP-6-4	3/8	1/4	9/16	1.01	1.24	.250
W171PLP-6-6	3/8	3/8	11/16	1.01	1.24	.250
W171PLP-8-6	1/2	3/8	11/16	1.15	1.31	.312
W171PLP-8-8	1/2	1/2	7/8	1.15	1.52	.312

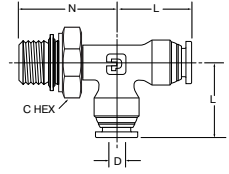

**171PLP Male Run Tee Swivel – BSPP**

PART NO.	TUBE SIZE MM	THREAD BSPP	C HEX	L MM	N MM	FLOW DIA. D
171PLP-4M-2G	4	1/8	9/16	19.05	24.02	3.17
171PLP-4M-4G	4	1/4	3/4	19.05	30.37	3.17
171PLP-6M-2G	6	1/8	9/16	20.90	23.92	4.77
171PLP-6M-4G	6	1/4	3/4	20.90	30.27	4.77
171PLP-6M-6G	6	3/8	7/8	20.90	32.30	4.77
171PLP-8M-2G	8	1/8	9/16	24.40	26.92	6.35
171PLP-8M-4G	8	1/4	3/4	24.20	33.02	6.35
171PLP-8M-6G	8	3/8	7/8	24.20	33.02	6.35
171PLP-10M-4G	10	1/4	3/4	25.52	33.02	7.13
171PLP-10M-6G	10	3/8	7/8	25.52	33.02	7.13
171PLP-10M-8G	10	1/2	1 1/16	25.52	37.84	7.13
171PLP-12M-4G	12	1/4	3/4	29.15	35.30	9.52
171PLP-12M-6G	12	3/8	7/8	29.15	35.30	9.52
171PLP-12M-8G	12	1/2	1 1/16	29.15	38.86	9.52

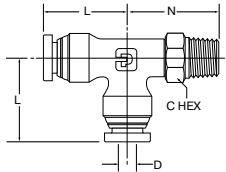

**W171PLP Male Run Tee Swivel – BSPT**

PART NO.	TUBE SIZE MM	THREAD BSPT	C HEX	L MM	N MM	FLOW DIA. D
W171PLP-4M-2R	4	1/8	7/16	19.05	23.95	3.17
W171PLP-4M-4R	4	1/4	9/16	19.05	28.60	3.17
W171PLP-6M-2R	6	1/8	7/16	20.90	23.92	4.77
W171PLP-6M-4R	6	1/4	9/16	20.90	28.49	4.77
W171PLP-6M-6R	6	3/8	11/16	20.90	30.78	4.77
W171PLP-8M-2R	8	1/8	9/16	24.20	26.16	6.35
W171PLP-8M-4R	8	1/4	9/16	24.20	31.75	6.35
W171PLP-8M-6R	8	3/8	11/16	24.20	31.75	6.35
W171PLP-10M-4R	10	1/4	9/16	25.52	31.75	7.13
W171PLP-10M-6R	10	3/8	11/16	25.52	31.75	7.13
W171PLP-10M-8R	10	1/2	7/8	25.52	37.84	7.13
W171PLP-12M-4R	12	1/4	11/16	29.15	32.77	9.52
W171PLP-12M-6R	12	3/8	11/16	29.15	33.52	9.52
W171PLP-12M-8R	12	1/2	7/8	29.15	38.86	9.52

**WARNING** These products can expose you to chemicals including LEAD which is known to the state of California to cause cancer and birth defects or other reproductive harm. For more information go to [www.P65Warnings.ca.gov](http://www.P65Warnings.ca.gov).



- A
- B
- C
- D
- E
- F
- G
- H
- I
- J
- K
- L
- M
- N
- O

[Click here for CADs, Product Specifications or to Configure Parts Online](#)

- A
- B
- C
- D
- E
- F
- G
- H
- I
- J
- K
- L
- M
- N
- O

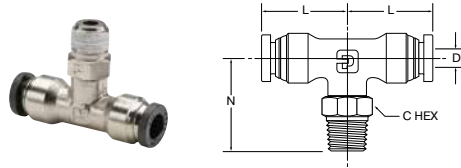

**W172PLP Male Branch Tee Swivel – NPTF**

PART NO.	TUBE SIZE IN	PIPE THREAD NPTF	C HEX	L	N	FLOW DIA. D
W172PLP-2-2	1/8	1/8	7/16	.74	.92	.094
W172PLP-3-2	3/16	1/8	7/16	.82	.92	.156
W172PLP-5/32-2	5/32	1/8	7/16	.77	.92	.125
172PLP-4-0	1/4	10-32	3/8	.84	.80	.250
W172PLP-4-2	1/4	1/8	7/16	.85	.92	.156
W172PLP-4-4	1/4	1/4	9/16	.85	1.10	.156
W172PLP-4-6	1/4	3/8	11/16	.85	1.10	.156
W172PLP-5-2	5/16	1/8	9/16	.97	1.02	.250
W172PLP-5-4	5/16	1/4	9/16	.97	1.24	.250
W172PLP-6-4	3/8	1/4	9/16	1.01	1.24	.250
W172PLP-6-6	3/8	3/8	11/16	1.01	1.24	.250
W172PLP-6-8	3/8	1/2	7/8	1.00	1.48	.250
W172PLP-8-4	1/2	1/4	9/16	1.15	1.30	.312
W172PLP-8-6	1/2	3/8	11/16	1.15	1.31	.312
W172PLP-8-8	1/2	1/2	7/8	1.15	1.52	.312

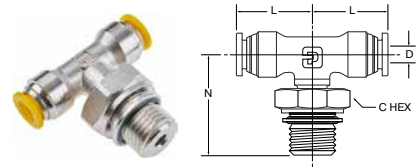

**172PLP Male Branch Tee Swivel – BSPP**

PART NO.	TUBE SIZE MM	THREAD BSPP	C HEX	L MM	N MM	FLOW DIA. D
172PLP-4M-2G	4	1/8	9/16	19.05	24.35	3.17
172PLP-4M-4G	4	1/4	3/4	19.05	30.70	3.17
172PLP-6M-2G	6	1/8	9/16	21.15	23.92	3.96
172PLP-6M-4G	6	1/4	3/4	21.15	30.27	3.96
172PLP-6M-6G	6	3/8	7/8	21.15	32.30	3.96
172PLP-8M-2G	8	1/8	9/16	24.20	27.33	6.35
172PLP-8M-4G	8	1/4	3/4	24.20	33.42	6.35
172PLP-8M-6G	8	3/8	7/8	24.20	33.42	6.35
172PLP-10M-4G	10	1/4	3/4	25.52	33.42	6.35
172PLP-10M-6G	10	3/8	7/8	25.52	33.42	6.35
172PLP-10M-8G	10	1/2	1 1/16	25.52	38.25	6.35
172PLP-12M-4G	12	1/4	3/4	28.65	35.56	7.95
172PLP-12M-6G	12	3/8	7/8	28.65	35.56	9.52
172PLP-12M-8G	12	1/2	1 1/16	28.65	39.11	9.52

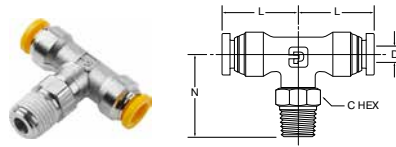

**W172PLP Male Branch Tee Swivel – BSPT**

PART NO.	TUBE SIZE MM	THREAD BSPT	C HEX	L MM	N MM	FLOW DIA. D
W172PLP-4M-2R	4	1/8	7/16	19.05	24.35	3.17
W172PLP-4M-4R	4	1/4	9/16	19.05	28.93	3.17
W172PLP-6M-2R	6	1/8	7/16	21.15	23.92	3.96
W172PLP-6M-4R	6	1/4	9/16	21.15	28.49	3.96
W172PLP-6M-6R	6	3/8	11/16	21.15	30.78	3.96
W172PLP-8M-2R	8	1/8	9/16	24.20	26.56	6.35
W172PLP-8M-4R	8	1/4	9/16	24.20	32.15	6.35
W172PLP-8M-6R	8	3/8	11/16	24.20	32.15	6.35
W172PLP-10M-4R	10	1/4	9/16	25.53	32.14	7.14
W172PLP-10M-6R	10	3/8	11/16	25.53	32.14	7.14
W172PLP-10M-8R	10	1/2	7/8	25.53	32.24	7.14
W172PLP-12M-4R	12	1/4	9/16	28.65	33.02	9.53
W172PLP-12M-6R	12	3/8	11/16	28.65	33.78	9.53
W172PLP-12M-8R	12	1/2	7/8	28.65	39.11	9.53

**WARNING** These products can expose you to chemicals including LEAD which is known to the state of California to cause cancer and birth defects or other reproductive harm. For more information go to [www.P65Warnings.ca.gov](http://www.P65Warnings.ca.gov).

[Click here for CADs, Product Specifications or to Configure Parts Online](#)

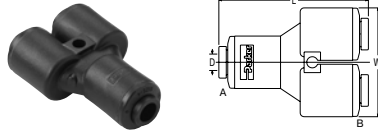

### 362PW – Union Y (PVDF) – Inch

PART NO.	TUBE SIZE IN	TUBE SIZE IN	L IN	W IN	FLOW DIA. D
362PW-4	1/4	1/4	2.100	1.43	0.190
362PW-4-6	3/8	1/4	2.100	1.43	0.190
362PW-6	3/8	3/8	2.175	1.75	0.250
362PW-6-8	1/2	3/8	2.370	1.93	0.250
362PW-8	1/2	1/2	2.370	1.93	0.380

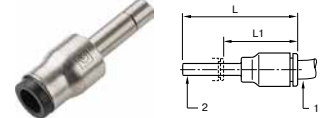

### 67PLP – Tube Reducer – Inch

PART NO.	1 TUBE SIZE IN	2 TUBE SIZE IN	L IN	L1 IN
67PLP-5/32-4	5/32	1/4	1.46	.81
67PLP-5/32-6	5/32	3/8	1.67	1.02
67PLP-5-6	5/16	3/8	1.83	1.06
67PLP-5-8	5/16	1/2	1.97	1.2
67PLP-4-6	1/4	3/8	1.75	1.07
67PLP-4-8	1/4	1/2	1.85	1.17
67PLP-6-8	3/8	1/2	1.97	1.2

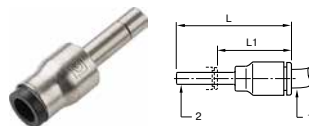

### 62PLPSP – Tube Expander – Inch

PART NO.	1 TUBE SIZE IN	2 TUBE SIZE IN	L IN	L1 IN
62PLPSP-4-5/32	1/4	5/32	1.39	.71
62PLPSP-6-4	3/8	1/4	1.66	.89

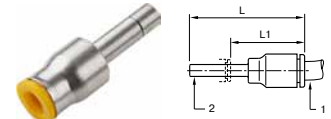

### 67PLP – Tube Reducer – Metric

PART NO.	1 TUBE SIZE MM	2 TUBE SIZE MM.	L MM	L1 MM
67PLP-10M-12M	10	12	48.8	25.8
67PLP-4M-10M	4	10	37.6	16.1
67PLP-4M-6M	4	6	34.5	24.5
67PLP-4M-8M	4	8	40.1	21.6
67PLP-6M-10M	6	10	41.4	20.9
67PLP-6M-12M	6	12	44.2	21.2
67PLP-6M-8M	6	8	38.6	23.1
67PLP-8M-10M	8	10	47	26.5
67PLP-8M-12M	8	12	49.3	24.8

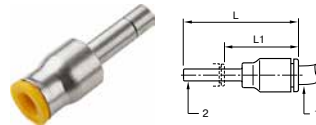

### 62PLPSP – Tube Expander – Metric

PART NO.	1 TUBE SIZE MM	2 TUBE SIZE MM	L MM	L1 MM
62PLPSP-10M-8M	10	8	42.7	21.2
62PLPSP-12M-10M	12	10	48.5	24
62PLPSP-6M-4M	6	4	33	21
62PLPSP-8M-6M	8	6	39.6	26.1

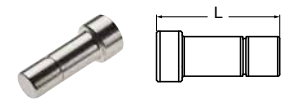

### 139PLP – Plug – Metric

PART NO.	TUBE SIZE MM	L IN
139PLP-6M	6	.92
139PLP-8M	5/16 (8mm)	1.10
139PLP-10M	10	1.22
139PLP-12M	12	1.34

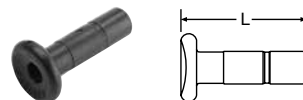

### TPL – Plug (PVDF) – Inch

PART NO.	TUBE SIZE IN	L IN
FB4TPL	1/4	.88
139PLP-8M	5/16	1.10
FB6TPL	3/8	1.45
FB8TPL	1/2	1.50

**WARNING** These products can expose you to chemicals including LEAD which is known to the state of California to cause cancer and birth defects or other reproductive harm. For more information go to [www.P65Warnings.ca.gov](http://www.P65Warnings.ca.gov).

- A
- B
- C
- D
- E
- F
- G
- H
- I
- J
- K
- L
- M
- N
- O

[Click here for CADs, Product Specifications or to Configure Parts Online](#)

- A
- B
- C
- D
- E
- F
- G
- H
- I
- J
- K
- L
- M
- N
- O



**DB – Dust/Weld Spatter Boot**

PART NO.	TUBE SIZE IN	L IN	D IN
DB-4	1/4 (6MM)	.50	.40
DB-6	3/8 (10MM)	.50	.63
DB-8	1/2 (12MM)	.50	.75



**0139 Bi-Material Captive Sealing Washer BSPP**

PART NO.	C BSPP	G MM	G2 MM	K MM	WT. OZ
0139 10 00	G1/8	14	1	1.8	.001
0139 13 00	G1/4	17	1	1.8	.001
0139 17 00	G3/8	22	1.3	2.1	.001
0139 21 00	G1/2	26	1.6	2.4	.002



**Tube Cutter**

PART NO.	DESCRIPTION
3000 71 11	Tube cutter for tubing and push-on hose. for hoses up to 1" (25mm). Weight: 1.09oz.
3000 71 11 05	Replacement Blades



**Tube Cutter**

PART NO.	DESCRIPTION
PTC-001	Plastic Tube Cutter – May be used with polyethylene, polypropylene, nylon, and other thermoplastic tubing. For tube O.D. sizes 1/8" to 1/2"
PTC-001RB	Replacement Blades



**Quick Release Tool**

PART NO.	DESCRIPTION
AQRT	Quick release tool makes disconnection of tube adapters and tubing a breeze.

**WARNING** These products can expose you to chemicals including LEAD which is known to the state of California to cause cancer and birth defects or other reproductive harm. For more information go to [www.P65Warnings.ca.gov](http://www.P65Warnings.ca.gov).







# Prestolok PLP Composite Push-to-Connect Fittings

Prestolok push-to-connect composite fittings with its wide variety configurations allows you to find the perfect product to meet your needs, optimizing the use of your equipment.

## Product Features:

- Stainless steel grab ring
- Glass-reinforced nylon 6.6 body
- Nitrile D-seal
- Nylon release button
- Corrosion and chemical resistance
- NPT, BSPT, BSPP, and metric threads
- Silicone Free

## Markets:

- Pneumatic
- Industrial
- Robotic
- Automation
- Printing
- Packaging
- Textile

## Compatible Media:

- Air
- Cutting Fluids
- Inert Gases

## Compatible Tubing:

- Semi-rigid nylon
- Polyurethane 95 Durometer Shore A\*
- Nylon
- Fluoropolymer
- Polyethylene

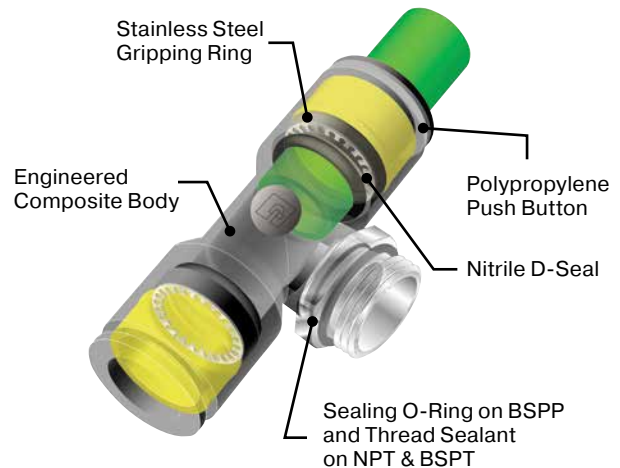

## Specifications:

<b>Pressure Range</b>	Up to 290 PSI (19.9 bar) depending on tubing
	Up to 260 PSI (17.9 bar) depending on tubing (3/16" size only)
<b>Temperature Range</b>	-4° to +175° F (-20° to +79.4° C)
	5° to +155° F (-15° to +68.3° C) (3/16" size only)
<b>Vacuum Rating</b>	28" Hg

\*Tube Support Required

## Assembly Instructions

1. Cut tubing squarely maximum of 15° angle allowable.
2. Check that port or mating part is clean and free of debris.
3. Mark tubing to appropriate tube insertion length. (see Tube Insertion Chart on page N22)
4. Insert tubing until it bottoms
5. Pull on tubing to verify it is fully inserted
6. To disassemble, simply press release button, hold against body and pull tubing out of fitting.

**WARNING** These products can expose you to chemicals including NICKEL, which is known to the state of California to cause cancer. For more information go to [www.P65Warnings.ca.gov](http://www.P65Warnings.ca.gov).



- A
- B
- C
- D
- E
- F
- G
- H
- I
- J
- K
- L
- M
- N
- O

**Threaded Fittings**

**W369PLP**

Male Elbow  
NPT, BSPT  
p. A22, A23



**W369PLPX**

Extended Male Elbow  
NPT, BSPT  
p. A24



**W379PLP**

45° Male Elbow  
NPT, BSPT  
p. A24, A25



**W372PLP**

Male Branch Tee  
NPT, BSPT  
p. A25, A26



**372PLP**

Male Branch Tee  
BSPP  
p. A27



**W371PLP**

Male Run Tee  
NPT, BSPT  
p. A27, A28



**W368PLP**

Male Y Connector  
NPT, BSPT  
p. A29



**W68LF**

Male Connector  
NPT, BSPT  
p. A20, A21



**68LFR**

Male Connector  
UNF, Straight  
p. A21



**66LF**

Female Connector  
NPT, BSPP  
p. A20



**377PLP**

Female Branch Tee  
NPT  
p. A27



**370PLP**

Female Elbow  
NPT, BSPP  
p. A30



**68LF**

Male Connector  
BSPP  
p. A22



**369PLP**

Male Elbow  
BSPP  
p. A23



**369PLPX**

Extended Male Elbow – BSPP  
p. A24



**379PLP**

45° Male Elbow  
BSPP  
p. A25



**371PLP**

Male Run Tee  
BSPP  
p. A28



**368PLP**

Male Y Connector  
BSPP  
p. A29



**W368PLPD**

Double Y Male Connector  
BSPT  
p. A30



**W369PLPO**

Oscillating Compact Elbow  
NPT, BSPT  
p. A43



**369PLPO**

Oscillating Compact Elbow  
BSPP  
p. A43



**Tube to Tube Fittings**

**32PLP**

Union  
p. A33



**365PLP**

Union Elbow  
p. A33, A34



**364PLP**

Union Tee  
p. A34



**362PLP**

Union Y  
p. A34



**362PLPD**

Double Y  
p. A35



**24PLP**

Multiple Tee  
p. A35



**24PLPD**

Double Multiple Tee  
p. A36



**347PLP**

Cross  
p. A36



**32PLPRC**

Connector for 2 Tubes  
p. A40



**32PLPDRC**

Connector for 3 Tubes  
p. A40



**Bulkhead Unions**

**32PLPBH**

Bulkhead Union  
p. A35



**365PLPBH**

Bulkhead Elbow  
p. A35



**32PLPBHP**

Plug-in Bulkhead Union  
p. A41



**WARNING** These products can expose you to chemicals including NICKEL, which is known to the state of California to cause cancer. For more information go to [www.P65Warnings.ca.gov](http://www.P65Warnings.ca.gov).

■ Standpipes

**W68PLPSP**

Male Standpipe  
NPT  
p. A28



**W68PLPSP**

Male Standpipe  
BSPT  
p. A28



**68PLPSP**

Male Standpipe  
BSPP  
p. A29



■ Plug-In Fittings

**369PLPSP**

Plug-In Elbow  
p. A36



**369PLPSPX**

Extended Plug-In  
Elbow  
p. A37



**379PLPSP**

Plug-In 45° Male  
Elbow  
p. A37



**372PLPSP**

Plug-In Branch Tee  
p. A37



**371PLPSP**

Plug-In Run Tee  
p. A37, A38



**362PLPSP**

Plug-In Y  
p. A38



**362PLPDSP**

Double Plug-In Y  
p. A38



**37PLP**

Tube Reducer  
p. A39



**32PLPSP**

Tube Expander  
p. A39



**32PLPSP**

Tube Converter  
p. A39



**322PLPSP**

Barbed Connector  
p. A39, A40



■ Modular Fittings

**369PLPBJ**

Single Banjo  
BSPP  
p. A31



**369PLPBJB**

Single Banjo Body  
p. A31



**32PLPDJB**

Double Banjo Body  
p. A31



**369PLPTJB**

Twin Banjo Body  
p. A31



**68BJB**

Single Banjo Bolt  
p. A31



**68BJBD**

Double Banjo Bolt  
p. A32



**68BJBT**

Triple Banjo Bolt  
p. A32



**66BJB**

Female Banjo Bolt  
p. A32



**376PLPBJ**

Banjo with Female  
Bolt  
p. A32



**369PLPTJ**

Twin Banjo  
p. A32



**32PLPDJ**

Double Banjo  
p. A32



**W369PLPBJ**

Single Banjo  
NPT, BSPT  
p. A30



**W369PLPTJ**

Twin Banjo  
NPT  
p. A32



■ Accessories

**63PLP**

Double Male Union  
p. A38



**639PLP**

Plug  
p. A39



**Clip**

p. A40



**3151**

End Cap  
p. A40



**AQRT**

Release Tool  
p. A41



**3110-3330**

End Cap  
p. A41



**WARNING** These products can expose you to chemicals including NICKEL, which is known to the state of California to cause cancer. For more information go to [www.P65Warnings.ca.gov](http://www.P65Warnings.ca.gov).



A

B

C

D

E

F

G

H

I

J

K

L

M

N

O

Click here for CADs, Product Specifications or to Configure Parts Online

- A
- B
- C
- D
- E
- F
- G
- H
- I
- J
- K
- L
- M
- N
- O

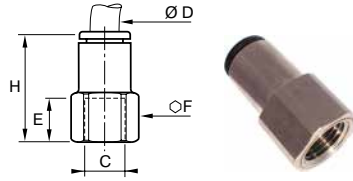

**66LF Female Connector – BSPP**

PART NO.	TUBE SIZE MM	THREAD BSPP	E MM	F MM	H MM
66LF-4M-M5	4	M5X0.8	6.5	8	19.5
66LF-4M-2G	4	1/8	9.5	13	22.5
66LF-4M-4G	4	1/4	13.5	16	26.5
66LF-6M-2G	6	1/8	9.5	13	24.5
66LF-6M-4G	6	1/4	13.5	16	28.5
66LF-8M-2G	8	1/8	9.5	13	29.0
66LF-8M-4G	8	1/4	13.5	16	33.0
66LF-8M-6G	8	3/8	14.0	19	34.0
66LF-10M-4G	10	1/4	13.5	16	36.0
66LF-10M-6G	10	3/8	14.0	19	36.0
66LF-10M-8G	10	1/2	19.5	24	41.5
66LF-12M-4G	12	1/4	14.0	19	39.5
66LF-12M-6G	12	3/8	14.0	19	40.0
66LF-12M-8G	12	1/2	19.5	24	45.5
66LF-14M-6G	14	3/8	14.0	22	42.5
66LF-16M-8G	16	1/2	15.0	27	49.0

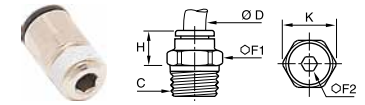

**W68LF Male Connector – NPT**

PART NO.	TUBE SIZE IN	C NPT	F1 MM	F2 IN	H IN	K IN
W68LF-2-1	1/8	1/16	10	.07	.413	.433
W68LF-2-2	1/8	1/8	11	.07	.283	.472
W68LF-2-4	1/8	1/4	14	.07	.315	.591
W68LF-4M-2	5/32 (4MM)	1/8	11	.11	.334	.472
W68LF-4M-4	5/32 (4MM)	1/4	14	.11	.275	.590
W68LF-4-2	1/4	1/8	11	.16	.472	.472
W68LF-4-4	1/4	1/4	14	.16	.374	.590
W68LF-4-6	1/4	3/8	18	.19	.295	.767
W68LF-8M-2	5/16 (8MM)	1/8	13	.19	.787	.551
W68LF-8M-4	5/16 (8MM)	1/4	14	.25	.661	.590
W68LF-8M-6	5/16 (8MM)	3/8	18	.25	.464	.767
W68LF-6-2	3/8	1/8	16	.16	.894	.689
W68LF-6-4	3/8	1/4	16	.28	.807	.689
W68LF-6-6	3/8	3/8	18	.28	.689	.767
W68LF-6-8	3/8	1/2	22	.28	.610	.945
W68LF-8-4	1/2	1/4	22	.25	1.100	.945
W68LF-8-6	1/2	3/8	22	.28	1.100	.945
W68LF-8-8	1/2	1/2	22	.28	1.100	.945

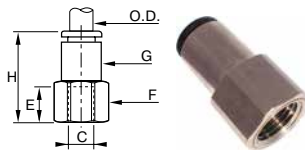

**66LF Female Connector – NPT**

PART NO.	TUBE SIZE IN	THREAD NPT	F MM	G IN	H IN	E IN
66LF-2-2	1/8	1/8	13	.43	.87	.37
66LF-2-4	1/8	1/4	16	.43	1.05	.55
66LF-4M-2	5/32 (4MM)	1/8	13	.35	.89	.37
66LF-4M-4	5/32 (4MM)	1/4	16	.33	1.06	.55
66LF-4-2	1/4	1/8	13	.42	.98	.37
66LF-4-4	1/4	1/4	16	.42	1.16	.55
66LF-8M-2	5/16 (8MM)	1/8	13	.53	1.14	.37
66LF-8M-4	5/16 (8MM)	1/4	16	.53	1.32	.55
66LF-6-2	3/8	1/8	16	.61	1.22	.37
66LF-6-4	3/8	1/4	16	.61	1.40	.55
66LF-6-6	3/8	3/8	22	.61	1.52	.65
66LF-8-4	1/2	1/4	20	.84	1.73	.47
66LF-8-6	1/2	3/8	22	.85	1.81	.65
66LF-8-8	1/2	1/2	24	.85	1.93	.77

**WARNING** These products can expose you to chemicals including NICKEL, which is known to the state of California to cause cancer. For more information go to [www.P65Warnings.ca.gov](http://www.P65Warnings.ca.gov).



Click here for CADs, Product Specifications or to Configure Parts Online

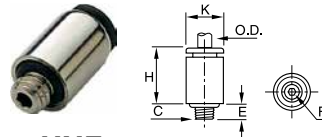

**68LFR Male Connector – UNF**

PART NO.	TUBE SIZE IN	C UNF	E IN	F MM	H IN	K IN
68LFR-2-0	1/8	10-32	.13	2.0	.49	.32
68LFR-4M-0	5/32 (4MM)	10-32	.13	2.0	.54	.34
68LFR-4-0	1/4	10-32	.13	2.0	.64	.46
68LFR-4-M5	1/4	M5	.14	2.5	.65	.41
68LFR-4-M7	1/4	M7	.18	4.0	.65	.41

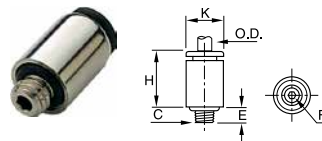

**68LFR Male Connector Metric Straight Thread**

PART NO.	TUBE SIZE MM	C UNF	E MM	F MM	H MM	K MM
68LFR-4M-M7	4	M7X1	4.6	3	14	9.95
68LFR-4M-M5	4	M5X0.8	3.5	2.5	14.5	8.50
68LFR-6M-M7	6	M7X1	4.6	3	16	9.90

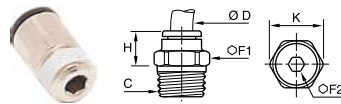

**W68LF Male Connector – BSPT**

PART NO.	TUBE SIZE IN	C BSPT	F1 MM	F2 MM	H IN	K IN
W68LF-2-2R	1/8	1/8	10	2	.335	.433
W68LF-5/32-2R	5/32	1/8	10	3	.370	.430
W68LF-5/32-4R	5/32	1/4	14	3	.260	.590
W68LF-3-2R	3/16	1/8	11	3	.610	.510
W68LF-3-4R	3/16	1/4	14	3	.590	.650
W68LF-4-2R	1/4	1/8	11	4	.472	.472
W68LF-4-4R	1/4	1/4	14	4	.374	.591
W68LF-5-2R	5/16	1/8	13	5	.790	.550
W68LF-5-4R	5/16	1/4	14	6	.670	.590
W68LF-5-6R	5/16	3/8	17	6	.510	.730
W68LF-5-8R	5/16	1/2	21	6	.470	.910
W68LF-6-4R	3/8	1/4	16	7	.807	.689
W68LF-6-6R	3/8	3/8	17	7	.650	.728
W68LF-6-8R	3/8	1/2	21	7	.551	.906
W68LF-8-4R	1/2	1/4	22	6	1.060	.945
W68LF-8-6R	1/2	3/8	22	7	1.020	.945
W68LF-8-8R	1/2	1/2	24	7	.807	1.020

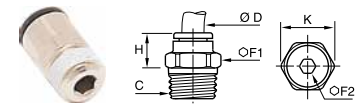

**W68LF Male Connector Metric to NPT**

PART NO.	TUBE SIZE MM	C NPT	F1 MM	F2 IN	H IN	K IN
W68LF-4M-2	4	1/8	11	3	.33	.47
W68LF-4M-4	4	1/4	14	3	.28	.59
W68LF-6M-2	6	1/8	11	4	.45	.47
W68LF-6M-4	6	1/4	14	4	.33	.59
W68LF-8M-2	8	1/8	13	5	.79	.55
W68LF-8M-4	8	1/4	14	6	.66	.59
W68LF-8M-6	8	3/8	18	6	.46	.77
W68LF-10M-4	10	1/4	16	7	.79	.69
W68LF-10M-6	10	3/8	18	8	.65	.77
W68LF-10M-8	10	1/2	22	8	.55	.95
W68LF-12M-6	12	3/8	19	9	.95	.83
W68LF-12M-8	12	1/2	22	10	.77	.95

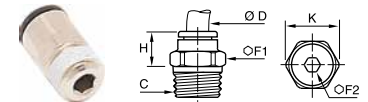

**W68LF Male Connector Metric to BSPT**

PART NO.	TUBE SIZE MM	C BSPT	F1 MM	F2 MM	H MM	K MM
W68LF-4M-2R	4	1/8	10	3	9.5	11.0
W68LF-4M-4R	4	1/4	14	3	6.5	15.0
W68LF-4M-6R	4	3/8	17	3	8.0	18.5
W68LF-6M-2R	6	1/8	11	4	11.5	11.0
W68LF-6M-4R	6	1/4	14	4	8.5	15.0
W68LF-6M-6R	6	3/8	17	4	8.5	18.5
W68LF-6M-8R	6	1/2	21	4	9.0	23.0
W68LF-8M-2R	8	1/8	13	5	20.0	14.0
W68LF-8M-4R	8	1/4	14	6	17.0	15.0
W68LF-8M-8R	8	1/2	21	6	12.0	23.0
W68LF-10M-2R	10	1/8	16	5	22.5	17.5
W68LF-10M-4R	10	1/4	16	7	20.0	17.5
W68LF-10M-6R	10	3/8	17	8	16.5	18.5
W68LF-10M-8R	10	1/2	21	8	14.0	23.0
W68LF-12M-4R	12	1/4	19	7	26.5	21.0
W68LF-12M-6R	12	3/8	19	9	24.0	21.0
W68LF-12M-8R	12	1/2	21	9	19.5	23.0
W68LF-14M-6R	14	3/8	22	9	28.5	24.0
W68LF-14M-8R	14	1/2	24	10	23.5	26.0

**WARNING** These products can expose you to chemicals including NICKEL, which is known to the state of California to cause cancer. For more information go to [www.P65Warnings.ca.gov](http://www.P65Warnings.ca.gov).



- A
- B
- C
- D
- E
- F
- G
- H
- I
- J
- K
- L
- M
- N
- O

Click here for CADs, Product Specifications or to Configure Parts Online

- A
- B
- C
- D
- E
- F
- G
- H
- I
- J
- K
- L
- M
- N
- O

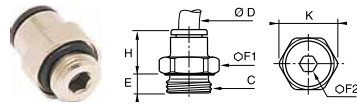

### 68LF Male Connector Metric to BSPP

PART NO.	TUBE SIZE MM	C BSPP	E MM	F1 MM	F2 MM	H MM	K MM
68LF-3M-M3	3	M3X0.5	2.50	8	-	12.5	8.5
68LF-3M-M5	3	M5X0.8	3.50	8	2.5	12.5	8.5
68LF-4M-M3	4	M3X0.5	2.50	8	-	14.5	8.5
68LF-4M-M5	4	M5X0.8	3.50	8	2.5	14.0	8.5
68LF-4M-M7	4	M7X1	5.00	10	2.5	14.0	11.0
68LF-4M-2G	4	1/8	4.50	13	3.0	11.5	14.0
68LF-4M-4G	4	1/4	5.50	16	3.0	10.5	17.5
68LF-6M-M5	6	M5X0.8	3.50	10	2.5	16.0	11.0
68LF-6M-M7	6	M7X1	5.00	10	3.0	16.0	11.0
68LF-6M-M10	6	M10X1	5.00	13	4.0	13.0	14.0
68LF-6M-M12	6	M12X1.5	5.50	15	4.0	13.0	16.0
68LF-6M-2G	6	1/8	4.50	13	4.0	13.0	14.0
68LF-6M-4G	6	1/4	5.50	16	4.0	12.5	17.5
68LF-6M-6G	6	3/8	5.50	20	4.0	13.0	22.0
68LF-6M-8G	6	1/2	7.50	24	4.0	20.0	26.0
68LF-8M-M10	8	M10X1	5.00	13	5.0	21.0	14.0
68LF-8M-M12	8	M12X1.5	5.50	15	5.0	21.0	16.0
68LF-8M-2G	8	1/8	4.50	13	5.0	20.5	14.0
68LF-8M-4G	8	1/4	5.50	16	6.0	19.5	17.5
68LF-8M-6G	8	3/8	5.50	20	6.0	18.0	22.0
68LF-8M-8G	8	1/2	7.50	24	6.0	16.5	26.0
68LF-10M-4G	10	1/4	5.50	16	7.0	23.0	17.5
68LF-10M-6G	10	3/8	5.50	20	8.0	19.5	22.0
68LF-10M-8G	10	1/2	7.50	24	8.0	18.5	26.0
68LF-12M-4G	12	1/4	5.50	19	7.0	27.5	21.0
68LF-12M-6G	12	3/8	5.50	20	9.0	27.0	22.0
68LF-12M-8G	12	1/2	7.00	24	10.0	22.5	26.0
68LF-14M-6G	14	3/8	5.50	22	9.0	29.5	24.0
68LF-14M-8G	14	1/2	7.00	24	11.0	28.0	26.0

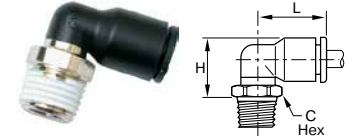

### W369PLP Male Elbow - NPT

PART NO.	TUBE SIZE IN	THREAD NPT / UNF	C HEX MM	L	H
369PLP-2-0	1/8	10-32	8	.57	.52
W369PLP-2-1	1/8	1/16	10	.57	.53
W369PLP-2-2	1/8	1/8	11	.57	.53
W369PLP-2-4	1/8	1/4	14	.57	.55
369PLP-4M-0	5/32 (4MM)	10-32	8	.55	.53
W369PLP-4M-2	5/32 (4MM)	1/8	11	.55	.53
W369PLP-4M-4	5/32 (4MM)	1/4	14	.55	.55
W369PLP-3-2	3/16	1/8	11	.85	.67
369PLP-4-0	1/4	10-32	11	.71	.63
W369PLP-4-2	1/4	1/8	11	.71	.67
W369PLP-4-4	1/4	1/4	14	.71	.63
W369PLP-4-6	1/4	3/8	18	.71	.65
W369PLP-8M-2	5/16 (8MM)	1/8	11	.91	.75
W369PLP-8M-4	5/16 (8MM)	1/4	14	.91	.71
W369PLP-8M-6	5/16 (8MM)	3/8	18	.91	.73
W369PLP-6-2	3/8	1/8	15	1.08	.91
W369PLP-6-4	3/8	1/4	15	1.08	.91
W369PLP-6-6	3/8	3/8	18	1.08	.87
W369PLP-6-8	3/8	1/2	22	1.08	.91
W369PLP-8-4	1/2	1/4	20	1.38	1.22
W369PLP-8-6	1/2	3/8	20	1.38	1.22
W369PLP-8-8	1/2	1/2	24	1.38	1.12



### W369PLP Male Elbow - BSPT

PART NO.	TUBE SIZE IN	THREAD BSPT	C HEX MM	L	H
W369PLP-2-2R	1/8	1/8	10	.57	.53
W369PLP-4M-2R	5/32 (4M)	1/8	10	.55	.53
W369PLP-4M-4R	5/32 (4M)	1/4	14	.55	.55
W369PLP-3-2R	3/16	1/8	11	.85	.67
W369PLP-4-2R	1/4	1/8	10	.71	.67
W369PLP-4-4R	1/4	1/4	14	.71	.63
W369PLP-8M-2R	5/16 (8M)	1/8	10	.91	.75
W369PLP-8M-4R	5/16 (8M)	1/4	14	.91	.71
W369PLP-8M-6R	5/16 (8M)	3/8	17	.91	.71
W369PLP-8M-8R	5/16 (8M)	1/2	21	.91	.77
W369PLP-6-4R	3/8	1/4	15	1.04	.87
W369PLP-6-6R	3/8	3/8	17	1.04	.87
W369PLP-8-4R	1/2	1/4	20	1.38	1.22
W369PLP-8-6R	1/2	3/8	20	1.38	1.22
W369PLP-8-8R	1/2	1/2	24	1.38	1.12

**WARNING** These products can expose you to chemicals including NICKEL, which is known to the state of California to cause cancer. For more information go to [www.P65Warnings.ca.gov](http://www.P65Warnings.ca.gov).



[Click here for CADs, Product Specifications or to Configure Parts Online](#)

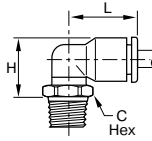

**W369PLP Male Elbow - NPT**

PART NO.	TUBE SIZE MM	THREAD NPT	C HEX MM	H	L
W369PLP-4M-2	4	1/8	11	.53	.55
W369PLP-4M-4	4	1/4	14	.55	.55
W369PLP-6M-2	6	1/8	11	.61	.63
W369PLP-6M-4	6	1/4	14	.63	.63
W369PLP-8M-2	8	1/8	11	.75	.91
W369PLP-8M-4	8	1/4	14	.71	.91
W369PLP-8M-6	8	3/8	18	.73	.91
W369PLP-10M-4	10	1/4	15	.91	1.04
W369PLP-10M-6	10	3/8	18	.87	1.04
W369PLP-10M-8	10	1/2	22	.91	1.04
W369PLP-12M-6	12	3/8	18	.98	1.22
W369PLP-12M-8	12	1/2	22	1.02	1.22

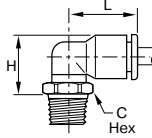

**W369PLP Male Elbow - BSPT**

PART NO.	TUBE SIZE MM	THREAD BSPT	C HEX MM	H	L
W369PLP-4M-2R	4	1/8	10	13.5	14.0
W369PLP-4M-4R	4	1/4	14	14.0	14.0
W369PLP-4M-6R	4	3/8	17	13.5	14.0
W369PLP-6M-2R	6	1/8	10	15.5	16.0
W369PLP-6M-4R	6	1/4	14	16.0	16.0
W369PLP-6M-6R	6	3/8	17	16.0	16.0
W369PLP-6M-8R	6	1/2	21	16.5	16.0
W369PLP-8M-2R	8	1/8	10	19.0	23.0
W369PLP-8M-4R	8	1/4	14	18.0	23.0
W369PLP-8M-6R	8	3/8	17	18.0	23.0
W369PLP-8M-8R	8	1/2	21	19.5	23.0
W369PLP-10M-2R	10	1/8	15	23.0	26.5
W369PLP-10M-4R	10	1/4	15	22.0	26.5
W369PLP-10M-6R	10	3/8	17	22.0	26.5
W369PLP-10M-8R	10	1/2	21	22.0	26.5
W369PLP-12M-4R	12	1/4	15	25.0	31.0
W369PLP-12M-6R	12	3/8	17	25.0	31.0
W369PLP-12M-8R	12	1/2	21	25.0	31.0
W369PLP-14M-6R	14	3/8	20	30.5	35.5
W369PLP-14M-8R	14	1/2	24	28.5	35.5
W369PLP-16M-6R	16	3/8	27	53	39.0
W369PLP-16M-8R	16	1/2	27	53	39.0

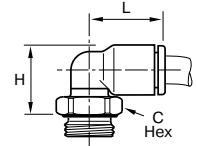

**369PLP Male Elbow - BSPP**

PART NO.	TUBE SIZE MM	BSPP / METRIC	C HEX MM	H	L
369PLP-3M-M3	3	M3X0.5	8	15.0	14.5
369PLP-3M-M5	3	M5X0.8	8	13.5	14.5
369PLP-4M-M3	4	M3X0.5	8	15.0	14.5
369PLP-4M-M5	4	M5X0.8	8	13.5	14.0
369PLP-4M-2G	4	1/8	13	13.0	14.0
369PLP-4M-4G	4	1/4	16	13.0	14.0
369PLP-6M-M5	6	M5X0.8	8	15.5	16.0
369PLP-6M-M7	6	M7X1	10	17.5	16.0
369PLP-6M-M10	6	M10X1	13	15.0	14.0
369PLP-6M-M12	6	M12X1.5	15	15.0	16.0
369PLP-6M-2G	6	1/8	13	15.0	16.0
369PLP-6M-4G	6	1/4	16	15.0	16.0
369PLP-6M-6G	6	3/8	20	15.5	16.0
369PLP-6M-8G	6	1/2	24	16.0	16.0
369PLP-8M-M10	8	M10X1	13	20.5	23.0
369PLP-8M-M12	8	M12X1.5	15	19.5	23.0
369PLP-8M-2G	8	1/8	13	20.5	23.0
369PLP-8M-4G	8	1/4	16	18.5	23.0
369PLP-8M-6G	8	3/8	20	18.5	23.0
369PLP-8M-8G	8	1/2	24	19.0	23.0
369PLP-10M-4G	10	1/4	16	23.5	26.5
369PLP-10M-6G	10	3/8	20	22.0	26.5
369PLP-10M-8G	10	1/2	24	22.0	26.5
369PLP-12M-4G	12	1/4	16	26.5	31.0
369PLP-12M-6G	12	3/8	20	25.0	31.0
369PLP-12M-8G	12	1/2	24	25.0	31.0
369PLP-14M-6G	14	3/8	20	32.5	35.5
369PLP-14M-8G	14	1/2	24	27.0	35.5
369PLP-16M-6G	16	3/8	27	54.5	39
369PLP-16M-8G	16	1/2	27	54.5	39

**WARNING** These products can expose you to chemicals including NICKEL, which is known to the state of California to cause cancer. For more information go to [www.P65Warnings.ca.gov](http://www.P65Warnings.ca.gov).



Click here for CADs, Product Specifications or to Configure Parts Online

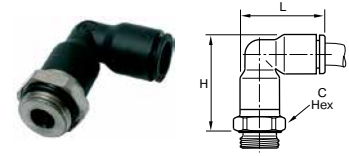
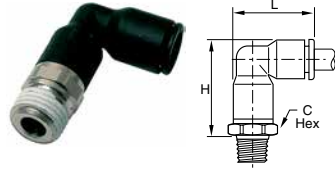

**W369PLPX Extended Male Elbow - NPT**

PART NO.	TUBE SIZE IN	THREAD NPT / UNF	C HEX MM	H	L
369PLPX-2-0	1/8	10-32	8	.91	.75
W369PLPX-2-2	1/8	1/8	11	.91	.75
W369PLPX-2-4	1/8	1/4	14	.93	.75
369PLPX-4M-0	5/32 (4MM)	10-32	8	.91	.75
W369PLPX-4M-2	5/32 (4MM)	1/8	11	.91	.75
W369PLPX-4M-4	5/32 (4MM)	1/4	14	.93	.75
369PLPX-4-0	1/4	10-32	11	1.10	.93
369PLPX-4-M7	1/4	M7	9	1.17	.93
W369PLPX-4-2	1/4	1/8	11	1.12	.93
W369PLPX-4-4	1/4	1/4	14	1.08	.93
W369PLPX-4-6	1/4	3/8	17	1.12	.93
W369PLPX-8M-2	5/16 (8MM)	1/8	13	1.32	1.16
W369PLPX-8M-4	5/16 (8MM)	1/4	14	1.28	1.16
W369PLPX-6-2	3/8	1/8	17	1.40	1.34
W369PLPX-6-4	3/8	1/4	17	1.41	1.33
W369PLPX-6-6	3/8	3/8	18	1.45	1.33

**369PLPX Extended Male Elbow - BSPP**

PART NO.	TUBE SIZE MM	BSPP / METRIC	C HEX MM	H
369PLPX-4M-M5	4	M5X0.8	8	23.0
369PLPX-4M-M7	4	M7X1	10	22.5
369PLPX-4M-2G	4	1/8	13	22.5
369PLPX-4M-4G	4	1/4	16	22.5
369PLPX-6M-M5	6	M5X0.8	10	27.5
369PLPX-6M-M7	6	M7X1	10	26.0
369PLPX-6M-2G	6	1/8	13	27.0
369PLPX-6M-4G	6	1/4	16	27.0
369PLPX-8M-2G	8	1/8	13	36.0
369PLPX-8M-4G	8	1/4	16	33.0
369PLPX-8M-6G	8	3/8	20	33.0
369PLPX-10M-4G	10	1/4	16	40.5
369PLPX-10M-6G	10	3/8	20	40.5
369PLPX-10M-8G	10	1/2	24	40.5
369PLPX-12M-4G	12	1/4	19	44.5
369PLPX-12M-6G	12	3/8	20	42.0
369PLPX-12M-8G	12	1/2	24	42.0
369PLPX-14M-6G	14	3/8	22	51.0
369PLPX-14M-8G	14	1/2	24	48.5

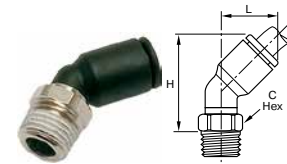
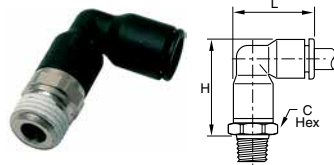

**W369PLPX Extended Male Elbow - BSPT**

PART NO.	TUBE SIZE MM	THREAD BSPT	C HEX MM	H	L
W369PLPX-4M-2R	4	1/8	10	23.0	19.0
W369PLPX-4M-4R	4	1/4	14	23.5	19.0
W369PLPX-6M-2R	6	1/8	10	27.0	22.5
W369PLPX-6M-4R	6	1/4	14	27.5	22.5
W369PLPX-8M-2R	8	1/8	13	34.5	29.5
W369PLPX-8M-4R	8	1/4	14	32.5	29.5
W369PLPX-8M-6R	8	3/8	17	33.0	29.5
W369PLPX-10M-4R	10	1/4	15	39.5	34.5
W369PLPX-10M-6R	10	3/8	17	39.5	34.5
W369PLPX-10M-8R	10	1/2	21	39.5	34.5
W369PLPX-12M-4R	12	1/4	19	45.5	40.5
W369PLPX-12M-6R	12	3/8	19	45.5	40.5
W369PLPX-12M-8R	12	1/2	21	45.5	40.5
W369PLPX-14M-6R	14	3/8	21	51.5	46.5
W369PLPX-14M-8R	14	1/2	21	51.5	46.5

**W379PLP Male Elbow 45° - NPT**

PART NO.	TUBE SIZE IN	THREAD NPT / UNF	C HEX MM	H	L
379PLP-2-0	1/8	10-32	8	.91	.49
W379PLP-2-2	1/8	1/8	11	.81	.49
W379PLP-4-2	1/4	1/8	11	.98	.57
W379PLP-4-4	1/4	1/4	14	.98	.57
W379PLP-6-4	3/8	1/4	17	1.36	.91
W379PLP-6-6	3/8	3/8	18	1.36	.91

**WARNING** These products can expose you to chemicals including NICKEL, which is known to the state of California to cause cancer. For more information go to [www.P65Warnings.ca.gov](http://www.P65Warnings.ca.gov).



Click here for CADs, Product Specifications or to Configure Parts Online

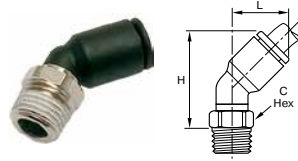

**W379PLP 45° Male Elbow - BSPT**

PART NO.	TUBE SIZE MM	BSPT	C HEX MM	H	L
W379PLP-4M-2R	4	1/8	10	24.5	13.0
W379PLP-6M-2R	6	1/8	10	28.0	14.5
W379PLP-6M-4R	6	1/4	14	30.0	14.5
W379PLP-8M-2R	8	1/8	10	33.5	19.5
W379PLP-8M-4R	8	1/4	14	33.5	19.5
W379PLP-8M-6R	8	3/8	17	33.5	19.5
W379PLP-10M-4R	10	1/4	15	38.5	23.0
W379PLP-10M-6R	10	3/8	17	39.0	23.0
W379PLP-10M-8R	10	1/2	21	40.5	23.0
W379PLP-12M-4R	12	1/4	15	44.0	26.0
W379PLP-12M-6R	12	3/8	17	44.0	26.0
W379PLP-12M-8R	12	1/2	21	46.0	26.0

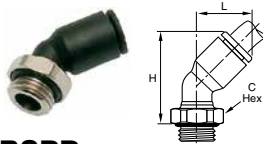

**379PLP 45° Male Elbow - BSPP**

PART NO.	TUBE SIZE MM	BSPP / M5	C HEX MM	H	L
379PLP-4M-M5	4	M5X0.8	8	23.0	13.0
379PLP-4M-2G	4	1/8	13	25.0	13.0
379PLP-6M-M5	6	M5X0.8	8	30.0	14.5
379PLP-6M-2G	6	1/8	13	28.5	14.5
379PLP-6M-4G	6	1/4	16	29.5	14.5
379PLP-8M-2G	8	1/8	13	36.0	19.5
379PLP-8M-4G	8	1/4	16	34.5	19.5
379PLP-8M-6G	8	3/8	20	34.5	19.5
379PLP-10M-4G	10	1/4	16	40.5	23.0
379PLP-10M-6G	10	3/8	20	39.0	23.0
379PLP-10M-8G	10	1/2	24	41.0	23.0
379PLP-12M-4G	12	1/4	16	46.0	26.0
379PLP-12M-6G	12	3/8	20	44.5	26.0
379PLP-12M-8G	12	1/2	24	46.0	26.0



**W372PLP Male Branch Tee - NPT**

PART NO.	TUBE SIZE IN	THREAD NPT / UNF	C HEX MM	L/2	H
372PLP-2-0	1/8	10-32	8	.57	.61
W372PLP-2-1	1/8	1/16	10	.57	.61
W372PLP-2-2	1/8	1/8	11	.57	.61
W372PLP-2-4	1/8	1/4	14	.57	.63
372PLP-4M-0	5/32 (4MM)	10-32	8	.55	.71
W372PLP-4M-4	5/32 (4MM)	1/4	14	.55	.63
W372PLP-3-2	3/16	1/8	11	.85	.67
W372PLP-4-2	1/4	1/8	11	.71	.67
W372PLP-4-4	1/4	1/4	14	.71	.63
W372PLP-4-6	1/4	3/8	18	.71	.65
W372PLP-5-2	5/16	1/8	11	.91	.87
W372PLP-5-4	5/16	1/4	14	.91	.83
W372PLP-5-6	5/16	3/8	18	.91	.85
W372PLP-6-2	3/8	1/8	15	1.04	.99
W372PLP-6-4	3/8	1/4	15	1.04	.99
W372PLP-6-6	3/8	3/8	18	1.04	.95
W372PLP-6-8	3/8	1/2	22	1.04	.98
W372PLP-8-4	1/2	1/4	20	1.38	1.22
W372PLP-8-6	1/2	3/8	20	1.38	1.22
W372PLP-8-8	1/2	1/2	24	1.38	1.21

**WARNING** These products can expose you to chemicals including NICKEL, which is known to the state of California to cause cancer. For more information go to [www.P65Warnings.ca.gov](http://www.P65Warnings.ca.gov).



Click here for CADs, Product Specifications or to Configure Parts Online

- A
- B
- C
- D
- E
- F
- G
- H
- I
- J
- K
- L
- M
- N
- O



**W372PLP Male Branch Tee - BSPT**

PART NO.	TUBE SIZE IN	THREAD BSPT	C HEX MM	L/2	H
W372PLP-2-2R	1/8	1/8	10	.55	.61
W372PLP-4M-2R	5/32 (4MM)	1/8	10	.55	.61
W372PLP-4M-4R	5/32 (4MM)	1/4	14	.55	.63
W372PLP-3-2R	3/16	1/8	11	.85	.67
W372PLP-3-4R	3/16	1/4	14	.85	.67
W372PLP-4-2R	1/4	1/8	10	.71	.67
W372PLP-4-4R	1/4	1/4	14	.71	.63
W372PLP-8M-2R	5/16 (8MM)	1/8	10	.91	.87
W372PLP-8M-4R	5/16 (8MM)	1/4	14	.91	.83
W372PLP-8M-6R	5/16 (8MM)	3/8	17	.91	.83
W372PLP-6-4R	3/8	1/4	15	1.04	.95
W372PLP-6-6R	3/8	3/8	17	1.04	.95
W372PLP-8-4R	1/2	1/4	20	1.38	1.24
W372PLP-8-6R	1/2	3/8	20	1.38	1.22

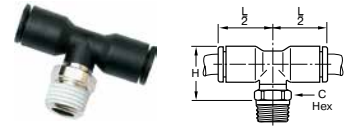

**W372PLP Male Branch Tee - BSPT**

PART NO.	TUBE SIZE MM	BSPT	C HEX MM	H	L/2
W372PLP-4M-2R	4	1/8	10	15.5	14.0
W372PLP-4M-4R	4	1/4	14	16.0	14.0
W372PLP-6M-2R	6	1/8	10	17.5	16.0
W372PLP-6M-4R	6	1/4	14	18.0	16.0
W372PLP-8M-2R	8	1/8	10	22.0	23.0
W372PLP-8M-4R	8	1/4	14	21.0	23.0
W372PLP-8M-6R	8	3/8	17	21.0	23.0
W372PLP-10M-4R	10	1/4	15	24.0	26.5
W372PLP-10M-6R	10	3/8	17	24.0	26.5
W372PLP-10M-8R	10	1/2	21	24.0	26.5
W372PLP-12M-4R	12	1/4	15	27.0	31.0
W372PLP-12M-6R	12	3/8	17	27.0	31.0
W372PLP-12M-8R	12	1/2	21	27.0	31.0
W372PLP-14M-6R	14	3/8	20	30.5	35.5
W372PLP-14M-8R	14	1/2	24	28.5	35.5
W372PLP-16M-6R	16	3/8	27	53.0	38.5
W372PLP-16M-8R	16	1/2	27	53.0	38.5

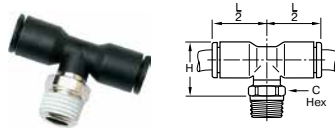

**W372PLP Male Branch Tee - NPT**

PART NO.	TUBE SIZE MM	NPT	C HEX MM	H	L/2
W372PLP-4M-2	4	1/8	11	.61	.55
W372PLP-4M-4	4	1/4	14	.63	.55
W372PLP-6M-2	6	1/8	11	.69	.63
W372PLP-6M-4	6	1/4	14	.71	.63
W372PLP-8M-2	8	1/8	11	.87	.91
W372PLP-8M-4	8	1/4	14	.83	.91
W372PLP-8M-6	8	3/8	18	.85	.91
W372PLP-10M-4	10	1/4	15	.98	1.04
W372PLP-10M-6	10	3/8	18	.95	1.04
W372PLP-10M-8	10	1/2	22	.98	1.04
W372PLP-12M-6	12	3/8	18	1.06	1.22
W372PLP-12M-8	12	1/2	22	.98	1.22

**WARNING** These products can expose you to chemicals including NICKEL, which is known to the state of California to cause cancer. For more information go to [www.P65Warnings.ca.gov](http://www.P65Warnings.ca.gov).



Click here for CADs, Product Specifications or to Configure Parts Online

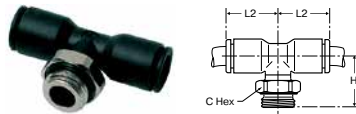

### 372PLP Male Branch Tee - BSPP

PART NO.	TUBE SIZE MM	BSPP / M5	C HEX MM	H	L/2
372PLP-4M-M5	4	M5X0.8	8	17.5	14.0
372PLP-4M-2G	4	1/8	13	15.0	14.0
372PLP-4M-4G	4	1/4	16	15.0	14.0
372PLP-6M-M5	6	M5X0.8	8	19.5	16.0
372PLP-6M-2G	6	1/8	13	17.0	16.0
372PLP-6M-4G	6	1/4	16	17.0	16.0
372PLP-8M-2G	8	1/8	13	23.5	23.0
372PLP-8M-4G	8	1/4	16	21.5	23.0
372PLP-8M-6G	8	3/8	20	21.5	23.0
372PLP-10M-4G	10	1/4	16	26.0	26.5
372PLP-10M-6G	10	3/8	20	24.0	26.5
372PLP-10M-8G	10	1/2	24	24.0	26.5
372PLP-12M-4G	12	1/4	16	29.0	31.0
372PLP-12M-6G	12	3/8	20	27.0	31.0
372PLP-12M-8G	12	1/2	24	27.0	31.0
372PLP-14M-6G	14	3/8	20	32.5	35.5
372PLP-14M-8G	14	1/2	24	27.0	35.5
372PLP-16M-6G	16	3/8	27	54.5	38.5
372PLP-16M-8G	16	1/2	27	54.5	38.5

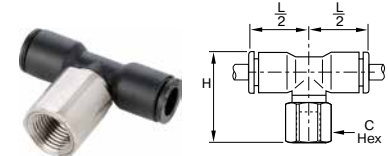

### 377PLP Female Branch Tee - NPT

PART NO.	TUBE SIZE IN	THREAD NPT / UNF	C HEX MM	L/2	H
377PLP-2-2	1/8	1/8	13	.57	.99
377PLP-4M-2	5/32 (4MM)	1/8	13	.55	.91
377PLP-4M-4	5/32 (4MM)	1/4	16	.55	1.08
377PLP-4-2	1/4	1/8	13	.71	1.02
377PLP-4-4	1/4	1/4	16	.71	1.18
377PLP-8M-2	5/16 (8MM)	1/8	13	.91	1.24
377PLP-8M-4	5/16 (8MM)	1/4	16	.91	1.40
377PLP-6-4	3/8	1/4	16	1.04	1.60
377PLP-8-6	1/2	3/8	22	1.38	1.88

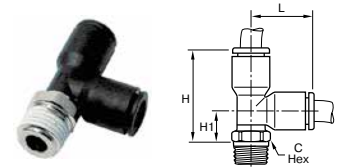

### W371PLP Male Run Tee - NPT

PART NO.	TUBE SIZE IN	THREAD NPT / UNF	C HEX MM	L	H	H1
371PLP-2-0	1/8	10-32	8	.57	.92	.35
W371PLP-2-1	1/8	1/16	10	.57	.93	.35
W371PLP-2-2	1/8	1/8	11	.57	.93	.35
371PLP-4M-0	5/32 (4MM)	10-32	8	.57	1.02	.45
W371PLP-4M-2	5/32 (4MM)	1/8	11	.57	.93	.53
W371PLP-4M-4	5/32 (4MM)	1/4	14	.57	.94	.37
W371PLP-3-2	3/16	1/8	11	.85	1.31	.45
W371PLP-4-2	1/4	1/8	11	.69	1.16	.45
W371PLP-4-4	1/4	1/4	14	.69	1.12	.41
W371PLP-4-6	1/4	3/8	18	.69	1.14	.43
W371PLP-8M-2	5/16 (8MM)	1/8	11	.91	1.38	.49
W371PLP-8M-4	5/16 (8MM)	1/4	14	.91	1.34	.45
W371PLP-8M-6	5/16 (8MM)	3/8	18	.91	1.36	.47
W371PLP-6-2	3/8	1/8	15	1.04	1.63	.60
W371PLP-6-4	3/8	1/4	15	1.04	1.63	.60
W371PLP-6-6	3/8	3/8	18	1.04	1.60	.55
W371PLP-6-8	3/8	1/2	22	1.04	1.63	.59
W371PLP-8-4	1/2	1/4	20	1.38	2.17	.79
W371PLP-8-6	1/2	3/8	20	1.38	2.17	.79
W371PLP-8-8	1/2	1/2	24	1.38	2.07	.79

**WARNING** These products can expose you to chemicals including NICKEL, which is known to the state of California to cause cancer. For more information go to [www.P65Warnings.ca.gov](http://www.P65Warnings.ca.gov).



- A
- B
- C
- D
- E
- F
- G
- H
- I
- J
- K
- L
- M
- N
- O

Click here for CADs, Product Specifications or to Configure Parts Online

- A
- B
- C
- D
- E
- F
- G
- H
- I
- J
- K
- L
- M
- N
- O

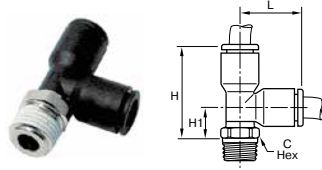

### W371PLP Male Run Tee - BSPT

PART NO.	TUBE SIZE MM	THREAD BSPT	C HEX MM	H	H1	L
W371PLP-4M-2R	4	1/8	10	23.5	9.0	14.5
W371PLP-4M-4R	4	1/4	14	24.0	9.5	14.5
W371PLP-6M-2R	6	1/8	10	27.5	10.0	17.5
W371PLP-6M-4R	6	1/4	14	28.0	10.5	17.5
W371PLP-8M-2R	8	1/8	10	35.0	12.0	23.0
W371PLP-8M-4R	8	1/4	14	34.0	11.0	23.0
W371PLP-8M-6R	8	3/8	17	34.0	11.0	23.0
W371PLP-10M-4R	10	1/4	15	40.5	14.0	26.5
W371PLP-10M-6R	10	3/8	17	40.5	14.0	26.5
W371PLP-10M-8R	10	1/2	21	40.5	14.0	26.5
W371PLP-12M-4R	12	1/4	15	46.5	15.5	31.0
W371PLP-12M-6R	12	3/8	17	46.5	15.5	31.0
W371PLP-12M-8R	12	1/2	21	46.5	15.5	31.0
W371PLP-14M-8R	14	1/2	24	52.5	17.5	35.5
W371PLP-16M-6R	16	3/8	27	38.5	78	39.5
W371PLP-16M-8R	16	1/2	27	38.5	78	39.5

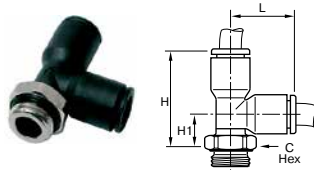

### 371PLP Male Run Tee - BSPP

PART NO.	TUBE SIZE MM	BSPP / M5	C HEX MM	H	H1	L
371PLP-4M-M5	4	M5X0.8	8	26.0	11.5	14.5
371PLP-4M-2G	4	1/8	13	23.0	8.5	14.5
371PLP-4M-4G	4	1/4	16	23.0	8.5	14.5
371PLP-6M-M5	6	M5X0.8	8	29.5	12.5	17.5
371PLP-6M-2G	6	1/8	13	27.0	10.0	17.5
371PLP-6M-4G	6	1/4	16	27.0	10.0	17.5
371PLP-8M-2G	8	1/8	13	36.5	14.0	23.0
371PLP-8M-4G	8	1/4	16	34.5	12.0	23.0
371PLP-8M-6G	8	3/8	20	34.5	12.0	23.0
371PLP-10M-4G	10	1/4	16	42.0	15.5	26.5
371PLP-10M-6G	10	3/8	20	40.5	14.0	26.5
371PLP-10M-8G	10	1/2	24	40.5	14.0	26.5
371PLP-12M-4G	12	1/4	16	48.0	17.0	31.0
371PLP-12M-6G	12	3/8	20	46.5	15.5	31.0
371PLP-12M-8G	12	1/2	24	46.5	15.5	31.0
371PLP-14M-6G	14	3/8	20	56.5	21.5	35.5
371PLP-14M-8G	14	1/2	24	51.0	16.0	35.5
371PLP-16M-6G	16	3/8	27	38.5	79.5	41
371PLP-16M-8G	16	1/2	27	38.5	79.5	41

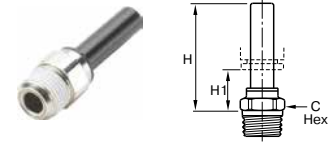

### W68PLPSP Male Standpipe - NPT

PART NO.	TUBE SIZE IN	THREAD NPT / UNF	C HEX MM	H	H1
68PLPSP-4M-0	5/32 (4MM)	10-32	8	1.24	
W68PLPSP-4M-2	5/32 (4MM)	1/8	11	1.02	.57
W68PLPSP-4M-4	5/32 (4MM)	1/4	14	1.04	.59
W68PLPSP-4-2	1/4	1/8	11	1.18	.61
W68PLPSP-4-4	1/4	1/4	14	1.12	.57
W68PLPSP-8M-2	5/16 (8MM)	1/8	11	1.16	.43
W68PLPSP-8M-4	5/16 (8MM)	1/4	14	1.12	.39
W68PLPSP-6-2	3/8	1/8	15	1.47	.81
W68PLPSP-6-4	3/8	1/4	15	1.42	.67
W68PLPSP-6-6	3/8	3/8	17	1.42	.61
W68PLPSP-8-6	1/2	3/8	17	1.44	.37
W68PLPSP-8-8	1/2	1/2	21	1.46	.39

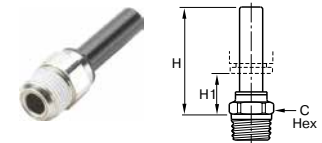

### W68PLPSP Male Standpipe - BSPT

PART NO.	TUBE SIZE MM	BSPT	C HEX MM	H	H1
W68PLPSP-4M-2R	4	1/8	10	26.0	14.0
W68PLPSP-4M-4R	4	1/4	14	26.5	14.5
W68PLPSP-6M-2R	6	1/8	10	28.0	14.0
W68PLPSP-6M-4R	6	1/4	14	28.5	14.5
W68PLPSP-8M-2R	8	1/8	10	29.5	11.0
W68PLPSP-8M-4R	8	1/4	14	28.5	10.0
W68PLPSP-10M-4R	10	1/4	15	36.0	15.5
W68PLPSP-10M-6R	10	3/8	17	36.0	15.5
W68PLPSP-10M-8R	10	1/2	21	36.0	15.5
W68PLPSP-12M-6R	12	3/8	17	36.5	12.0
W68PLPSP-12M-8R	12	1/2	21	36.5	12.0

**WARNING** These products can expose you to chemicals including NICKEL, which is known to the state of California to cause cancer. For more information go to [www.P65Warnings.ca.gov](http://www.P65Warnings.ca.gov).



[Click here for CADs, Product Specifications or to Configure Parts Online](#)

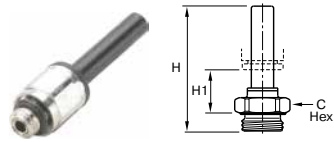

**68PLPSP Male Standpipe - BSPP**

PART NO.	TUBE SIZE MM	BSPP	C HEX MM	H	H1
68PLPSP-4M-M5	4	M5X0.8	8	31.0	16.0
68PLPSP-4M-2G	4	1/8	13	30.0	13.5
68PLPSP-4M-4G	4	1/4	16	31.0	13.5
68PLPSP-6M-2G	6	1/8	13	32.0	13.5
68PLPSP-6M-4G	6	1/4	16	33.0	13.5
68PLPSP-8M-2G	8	1/8	13	35.5	12.5
68PLPSP-8M-4G	8	1/4	16	34.5	10.5
68PLPSP-8M-6G	8	3/8	20	34.5	10.5
68PLPSP-10M-4G	10	1/4	16	43.5	17.5
68PLPSP-10M-6G	10	3/8	20	41.5	15.5
68PLPSP-10M-8G	10	1/2	24	41.5	15.5
68PLPSP-12M-6G	12	3/8	20	42.0	12.0
68PLPSP-12M-8G	12	1/2	24	43.5	12.0
68PLPSP-14M-6G	14	3/8	20	46.5	14.0
68PLPSP-14M-8G	14	1/2	24	48.0	13.5

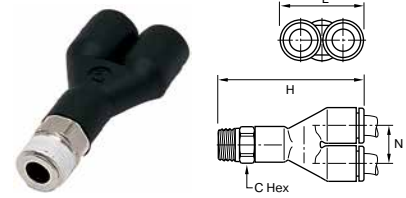

**W368PLP Male Y Connector - BSPT**

PART NO.	TUBE SIZE MM	BSPT	C HEX MM	H	L	N
W368PLP-4M-2R	4	1/8	10	32.5	17.5	9.0
W368PLP-4M-4R	4	1/4	14	33.0	17.5	9.0
W368PLP-6M-2R	6	1/8	10	39.5	21.5	1.0
W368PLP-6M-4R	6	1/4	14	40.0	21.5	1.0
W368PLP-8M-2R	8	1/8	13	56.5	28.0	14.5
W368PLP-8M-4R	8	1/4	14	55.5	28.0	14.5
W368PLP-8M-6R	8	3/8	16	48.5	28.0	14.5
W368PLP-10M-4R	10	1/4	14	60.0	39.0	20.0
W368PLP-10M-6R	10	3/8	16	60.5	39.0	20.0
W368PLP-10M-8R	10	1/2	24	61.0	39.0	20.0
W368PLP-12M-6R	12	3/8	19	66.0	39.0	20.0
W368PLP-12M-8R	12	1/2	21	66.0	39.0	20.0

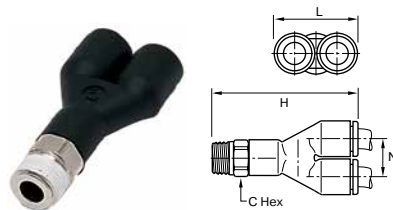

**W368PLP Male Y Connector - NPT**

PART NO.	TUBE SIZE IN	THREAD NPT	C HEX MM	H	L	N
W368PLP-4M-2	5/32 (4MM)	1/8	11	1.28	.69	.35
W368PLP-4M-4	5/32 (4MM)	1/4	14	1.30	.69	.35
W368PLP-4-2	1/4	1/8	11	1.61	.87	.45
W368PLP-4-4	1/4	1/4	14	1.56	.87	.45
W368PLP-6-4	3/8	1/4	17	2.24	1.30	.67
W368PLP-6-6	3/8	3/8	18	2.28	1.30	.67

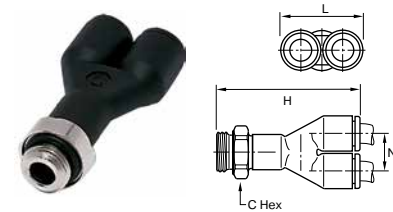

**368PLP Male Y Connector - BSPP**

PART NO.	TUBE SIZE MM	BSPP / M5	C HEX MM	H	L	N
368PLP-4M-M5	4	M5X0.8	8	32.5	17.5	9.0
368PLP-4M-2G	4	1/8	13	32.0	17.5	9.0
368PLP-4M-4G	4	1/4	16	32.0	17.5	9.0
368PLP-6M-M5	6	M5X0.8	10	39.5	21.5	11.0
368PLP-6M-2G	6	1/8	13	39.0	21.5	11.0
368PLP-6M-4G	6	1/4	16	39.0	21.5	11.0
368PLP-8M-2G	8	1/8	13	56.0	28.0	14.5
368PLP-8M-4G	8	1/4	16	55.0	28.0	14.5
368PLP-8M-6G	8	3/8	19	54.0	28.0	14.5
368PLP-10M-4G	10	1/4	16	63.5	33.0	17.0
368PLP-10M-6G	10	3/8	20	63.5	33.0	17.0
368PLP-10M-8G	10	1/2	20	65.0	33.0	17.0
368PLP-12M-6G	12	3/8	19	68.0	39.0	20.0
368PLP-12M-8G	12	1/2	24	70.0	39.0	20.0

**WARNING** These products can expose you to chemicals including NICKEL, which is known to the state of California to cause cancer. For more information go to [www.P65Warnings.ca.gov](http://www.P65Warnings.ca.gov).



- A
- B
- C
- D
- E
- F
- G
- H
- I
- J
- K
- L
- M
- N
- O

Click here for CADs, Product Specifications or to Configure Parts Online

- A
- B
- C
- D
- E
- F
- G
- H
- I
- J
- K
- L
- M
- N
- O

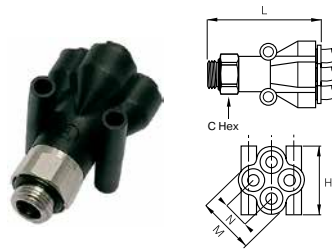

**W368PLPD Double Y Male Connector - BSPT**

PART NO.	TUBE SIZE MM	BSPT	C HEX MM	H	L	M	N	MOUNTING HOLE DIA
W368PLPD-4M-2R	4	1/8	13	25.5	41.5	21.0	10.0	3.7
W368PLPD-4M-4R	4	1/4	16	25.5	43.5	21.0	10.0	3.7
W368PLPD-6M-2R	6	1/8	19	31.5	54.5	26.5	12.0	3.7
W368PLPD-6M-4R	6	1/4	19	31.5	57.5	26.5	12.0	3.7

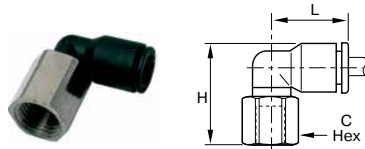

**370PLP Female Elbow Swivel - NPT**

PART NO.	TUBE SIZE IN	THREAD NPT	C HEX MM	L	H
370PLP-2-2	1/8	1/8	13	.57	.91
370PLP-4M-2	5/32 (4MM)	1/8	13	.55	.91
370PLP-4M-4	5/32 (4MM)	1/4	16	.55	1.08
370PLP-4-2	1/4	1/8	13	.71	1.02
370PLP-4-4	1/4	1/4	16	.71	1.18
370PLP-8M-2	5/16 (8MM)	1/8	13	.91	1.12
370PLP-8M-4	5/16 (8MM)	1/4	16	.91	1.28
370PLP-6-2	3/8	1/8	16	1.04	1.52
370PLP-6-4	3/8	1/4	16	1.04	1.52
370PLP-8-6	1/2	3/8	22	1.38	1.88

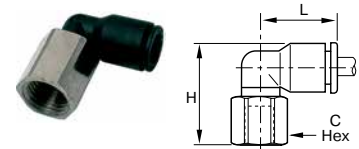

**370PLP Female Elbow - BSPP**

PART NO.	TUBE SIZE MM	BSPP	C HEX MM	H	L
370PLP-4M-2G	4	1/8	13	23.0	14.0
370PLP-4M-4G	4	1/4	16	27.0	14.0
370PLP-6M-2G	6	1/8	13	25.0	16.0
370PLP-6M-4G	6	1/4	16	29.0	16.0
370PLP-8M-2G	8	1/8	13	28.0	23.0
370PLP-8M-4G	8	1/4	16	32.0	23.0
370PLP-8M-6G	8	3/8	19	33.0	23.0
370PLP-10M-4G	10	1/4	16	34.5	26.5
370PLP-10M-6G	10	3/8	19	35.0	26.5
370PLP-10M-8G	10	1/2	24	41.0	26.5
370PLP-12M-4G	12	1/4	16	38.0	30.5
370PLP-12M-6G	12	3/8	19	38.5	30.5
370PLP-12M-8G	12	1/2	24	43.5	30.5

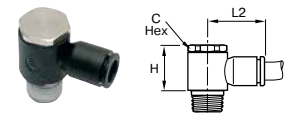

**W369PLPBJ Banjo - NPT**

PART NO.	TUBE SIZE IN	THREAD NPT / UNF	C HEX MM	H	L2
369PLPBJ-2-0	1/8	10-32		.79	.65
369PLPBJ-4M-0	5/32 (4MM)	10-32		.79	.65
W369PLPBJ-4M-2	5/32 (4MM)	1/8	13	.73	.73
369PLPBJ-4-0	1/4	10-32		.79	.73
W369PLPBJ-4-2	1/4	1/8	13	.73	.83
W369PLPBJ-4-4	1/4	1/4	17	.89	.91
W369PLPBJ-4-6	1/4	3/8	21	1.04	1.12
W369PLPBJ-6-4	3/8	1/4	17	.89	1.12
W369PLPBJ-6-6	3/8	3/8	21	1.04	1.20

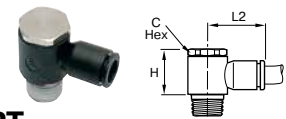

**W369PLPBJ Banjo - BSPT**

PART NO.	TUBE SIZE MM	BSPT	C HEX MM	H	L2
W369PLPBJ-6M-2R	6	1/8	13	18.5	20.0
W369PLPBJ-6M-4R	6	1/4	17	22.5	22.0
W369PLPBJ-8M-2R	8	1/8	13	18.5	25.0
W369PLPBJ-8M-4R	8	1/4	17	22.5	27.0
W369PLPBJ-10M-4R	10	1/4	17	22.5	29.0
W369PLPBJ-10M-6R	10	3/8	21	26.5	31.0
W369PLPBJ-12M-4R	12	1/4	21	26.5	34.5
W369PLPBJ-12M-6R	12	3/8	21	26.5	34.5

**WARNING** These products can expose you to chemicals including NICKEL, which is known to the state of California to cause cancer. For more information go to [www.P65Warnings.ca.gov](http://www.P65Warnings.ca.gov).



Click here for CADs, Product Specifications or to Configure Parts Online

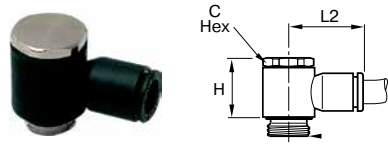

### 369PLPBJ Banjo - BSPP

PART NO.	TUBE SIZE MM	BSPP / METRIC	C HEX MM	H	L2
369PLPBJ-3M-M3*	3	M3X0.5		13.0	16.0
369PLPBJ-4M-M5*	4	M5X0.8		13.0	16.0
369PLPBJ-4M-2G	4	1/8	13	17.0	18.5
369PLPBJ-6M-M5*	6	M5X0.8		13.0	18.5
369PLPBJ-6M-2G	6	1/8	13	17.0	20.0
369PLPBJ-6M-4G	6	1/4	17	21.0	22.0
369PLPBJ-8M-2G	8	1/8	13	16.5	25.0
369PLPBJ-8M-4G	8	1/4	17	21.0	27.0
369PLPBJ-8M-6G	8	3/8	20	24.5	29.0
369PLPBJ-10M-4G	10	1/4	17	21.0	29.0
369PLPBJ-10M-6G	10	3/8	20	24.5	31.0
369PLPBJ-10M-8G	10	1/2	25	27.5	36.5
369PLPBJ-12M-6G	12	3/8	20	24.5	34.5
369PLPBJ-12M-8G	12	1/2	25	27.5	36.5

\*With screwdriver slot

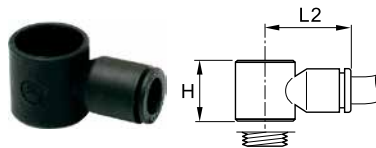

### 369PLPBJB Banjo Bodies

PART NO.	TUBE SIZE MM	BSPP / M5	H	L2
369PLPBJB-4M-M5	4	M5X0.8	13.0	16.0
369PLPBJB-4M-2G	4	1/8	14.5	18.5
369PLPBJB-6M-M5	6	M5X0.8	13.0	18.5
369PLPBJB-6M-2G	6	1/8	14.5	20.0
369PLPBJB-6M-4G	6	1/4	18.0	22.0
369PLPBJB-8M-2G	8	1/8	14.5	25.0
369PLPBJB-8M-4G	8	1/4	18.0	27.0
369PLPBJB-8M-6G	8	3/8	21.5	29.0
369PLPBJB-10M-4G	10	1/4	18.0	29.0
369PLPBJB-10M-6G	10	3/8	21.5	31.0
369PLPBJB-12M-6G	12	3/8	21.5	34.5

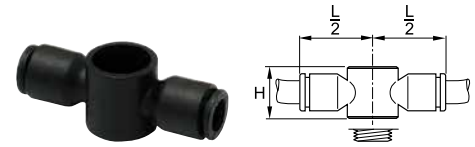

### 32PLPDJB Double Banjo Bodies

PART NO.	TUBE SIZE MM	BSPP / M5	H	L/2
32PLPDJB-6M-2G	6	1/8	14.4	20.0
32PLPDJB-6M-4G	6	1/4	18.0	26.0
32PLPDJB-8M-4G	8	1/4	18.0	27.0

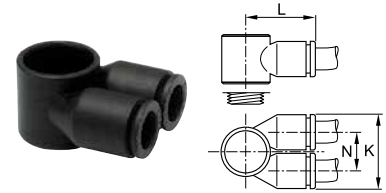

### 369PLTJB Twin Banjo Bodies

PART NO.	TUBE SIZE MM	BSPP / M5	K	L	N
369PLTJB-4M-4G	4	1/4	28.0	25.0	14.5
369PLTJB-6M-2G	6	1/8	22.5	20.5	12.0
369PLTJB-6M-4G	6	1/4	28.0	25.0	14.5
369PLTJB-6M-6G	6	3/8	33.0	28.5	17.0
369PLTJB-8M-4G	8	1/4	28.0	26.0	14.5
369PLTJB-8M-6G	8	3/8	33.0	29.5	17.0

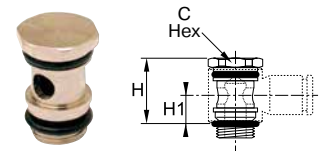

### 68BJB Single Banjo Bolt

PART NO.	BSPP / M5	C HEX MM	H	H1
68BJB-M5*	M5X0.8		17.0	7.5
68BJB-2G	1/8	13	17.0	7.5
68BJB-4G	1/4	17	21.0	9.5
68BJB-6G	3/8	20	24.5	11.0

\*With screwdriver slot

**WARNING** These products can expose you to chemicals including NICKEL, which is known to the state of California to cause cancer. For more information go to [www.P65Warnings.ca.gov](http://www.P65Warnings.ca.gov).



Click here for CADs, Product Specifications or to Configure Parts Online

- A
- B
- C
- D
- E
- F
- G
- H
- I
- J
- K
- L
- M
- N
- O

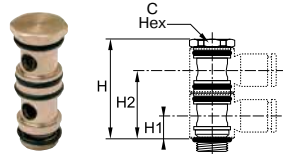

### 68BJBD Double Banjo Bolt

PART NO.	BSPP / M5	C HEX MM	H	H1	H2
68BJBD-M5*	M5X0.8		24.5	7.5	18.5
68BJBD-2G	1/8	13	31.0	7.5	22.0
68BJBD-4G	1/4	17	39.0	9.5	27.5
68BJBD-6G	3/8	20	46.0	11.0	32.5

\*With screwdriver slot

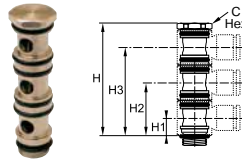

### 68BJBT Triple Banjo Bolt

PART NO.	BSPP	C HEX MM	H	H1	H2	H3
68BJBT-2G	1/8	13	45.5	7.5	22.0	36.0
68BJBT-4G	1/4	17	54.0	9.5	27.5	45.5
68BJBT-6G	3/8	20	67.5	11.0	32.5	54.0

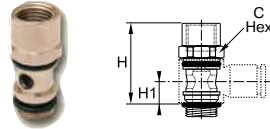

### 66BJB Female Threaded Banjo Bolt

PART NO.	1 BSPP / M5	2 BSPP / M5	C HEX MM	H	H1
66BJB-2G	1/8	1/8	13	24.5	7.5
66BJB-4G	1/4	1/4	17	33.0	9.5
66BJB-6G	3/8	3/8	20	37.5	11.0
66BJB-8G	1/2	1/2	25	42.0	11.5

\*With screwdriver slot

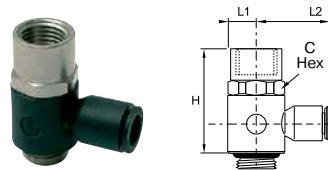

### 376PLPBJ Banjo with Female Bolt

PART NO.	TUBE SIZE MM	BSPP / M5	C HEX MM	H	L1	L2
376PLPBJ-4M-2G	4	1/8	13	25.5	7.0	18.5
376PLPBJ-6M-4G	6	1/4	17	33.0	9.0	22.0
376PLPBJ-8M-6G	8	3/8	20	37.5	11	29.0



### W369PLPTJ Twin Banjo - NPT

PART NO.	TUBE SIZE IN	THREAD NPT / UNF	C HEX MM	H	L2
369PLPTJ-4M-0	5/32 (4MM)	10-32		.63	.61
W369PLPTJ-4M-2	5/32 (4MM)	1/8	13	.73	.73
W369PLPTJ-4-2	1/4	1/8	13	.73	.73
W369PLPTJ-4-4	1/4	1/4	17	.89	1.04
W369PLPTJ-6-4	3/8	1/4	21	1.04	1.22
W369PLPTJ-6-6	3/8	3/8	21	1.04	1.22

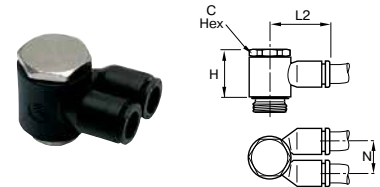

### 369PLPTJ Twin Banjo - BSPP, M5

PART NO.	TUBE SIZE MM	BSPP / M5	C HEX MM	H	L2	N
369PLPTJ-4M-M5	4	M5X0.8		13.0	16.0	9.0
369PLPTJ-4M-2G	4	1/8	13	16.5	18.5	11.5
369PLPTJ-6M-2G	6	1/8	13	16.5	18.5	11.5
369PLPTJ-6M-4G	6	1/4	17	21.0	27.0	14.5
369PLPTJ-8M-4G	8	1/4	17	21.0	27.0	14.5
369PLPTJ-8M-6G	8	3/8	20	24.5	31.0	17.0
369PLPTJ-10M-6G	10	3/8	20	24.5	31.0	17.0

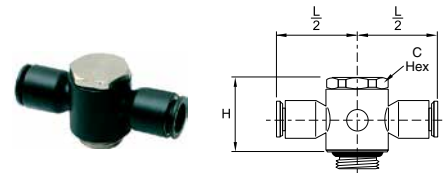

### 32PLPDJ Double Banjo - BSPP, M5

PART NO.	TUBE SIZE MM	BSPP / M5	C HEX MM	H	L/2
32PLPDJ-4M-M5	4	M5X0.8		13.0	16.0
32PLPDJ-6M-2G	6	1/8	13	17.0	20.0
32PLPDJ-6M-4G	6	1/4	17	21.0	26.5
32PLPDJ-8M-4G	8	1/4	17	21.0	27.0
32PLPDJ-8M-6G	8	3/8	20	24.5	30.5

**WARNING** These products can expose you to chemicals including NICKEL, which is known to the state of California to cause cancer. For more information go to [www.P65Warnings.ca.gov](http://www.P65Warnings.ca.gov).





[Click here for CADs, Product Specifications or to Configure Parts Online](#)

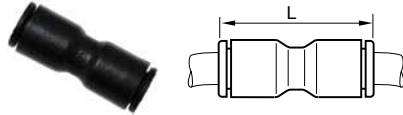

### 32PLP Equal Union

PART NO.	TUBE SIZE IN	L
32PLP-2	1/8	.97
32PLP-3	3/16	1.44
32PLP-4	1/4	1.16
32PLP-6	3/8	1.65
32PLP-8	1/2	2.17

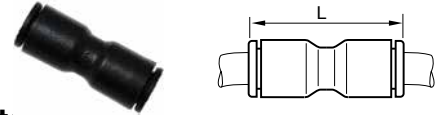

### 32PLP Converter

PART NO.	TUBE SIZE IN	TUBE SIZE MM	L
32PLP-6M-4	1/4	6	1.18
32PLP-10M-6	3/8	10	1.99
32PLP-12M-8	1/2	12	2.25

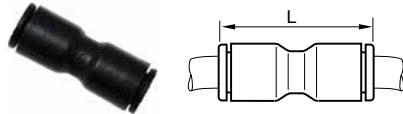

### 32PLP Unequal Union

PART NO.	1 TUBE SIZE IN	2 TUBE SIZE IN	L
32PLP-4M-2	5/32 (4M)	1/8	0.96
32PLP-4M-4	5/32 (4M)	1/4	1.16
32PLP-4-2	1/4	1/8	1.32
32PLP-4-8M	1/4	5/16 (8M)	1.44
32PLP-6-4	3/8	1/4	1.61
32PLP-6-8	3/8	1/2	2.17

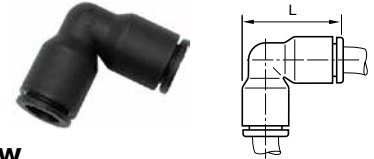

### 365PLP Union Elbow

PART NO.	TUBE SIZE IN	L
365PLP-2	1/8	.71
365PLP-3	3/16	1.07
365PLP-4	1/4	.93
365PLP-6	3/8	1.33
365PLP-8	1/2	1.38

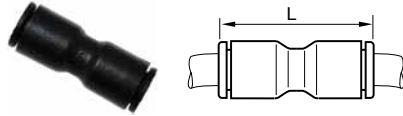

### 32PLP Union

PART NO.	TUBE SIZE MM	L
32PLP-3M	3	25.0
32PLP-4M	4	25.0
32PLP-6M	6	28.5
32PLP-8M	8	38.0
32PLP-10M	10	42.0
32PLP-12M	12	50.5
32PLP-14M	14	56.0
32PLP-16M	16	60.5



### 365PLP Unequal Union Elbow

PART NO.	1 TUBE SIZE IN	2 TUBE SIZE IN	L	H
365PLP-2-4	1/8	1/4	.93	.93
365PLP-4M-4	5/32 (4M)	1/4	.93	.93
365PLP-6-4	3/8	1/4	1.33	1.30
365PLP-6-8	3/8	1/2	1.81	1.81

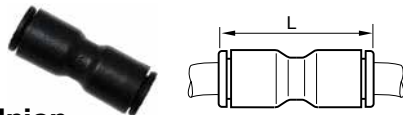

### 32PLP Unequal Union

PART NO.	1 TUBE SIZE MM	2 TUBE SIZE MM	L
32PLP-3M-4M	3	4	25.0
32PLP-6M-4M	6	4	28.0
32PLP-8M-4M	8	4	28.0
32PLP-8M-6M	8	6	38.0
32PLP-10M-6M	10	6	42.0
32PLP-10M-8M	10	8	42.0
32PLP-12M-8M	12	8	50.5
32PLP-12M-10M	12	10	50.5
32PLP-12M-14M	12	14	56.0
32PLP-12M-16M	16	12	61.0

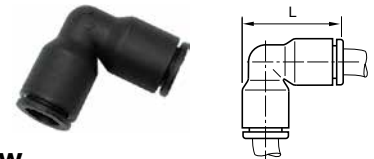

### 365PLP Union Elbow

PART NO.	TUBE SIZE MM	L
365PLP-4M	4	19.0
365PLP-6M	6	22.5
365PLP-8M	8	29.5
365PLP-10M	10	34.5
365PLP-12M	12	40.5
365PLP-14M	14	46.5
365PLP-16M	16	52.0

**WARNING** These products can expose you to chemicals including NICKEL, which is known to the state of California to cause cancer. For more information go to [www.P65Warnings.ca.gov](http://www.P65Warnings.ca.gov).



- A
- B
- C
- D
- E
- F
- G
- H
- I
- J
- K
- L
- M
- N
- O

Click here for CADs, Product Specifications or to Configure Parts Online

- A
- B
- C
- D
- E
- F
- G
- H
- I
- J
- K
- L
- M
- N
- O

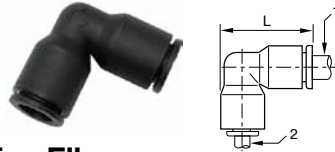

### 365PLP Unequal Union Elbow

PART NO.	1 TUBE SIZE MM	2 TUBE SIZE MM	L
365PLP-4M-6M	4	6	22.5
365PLP-6M-8M	6	8	29.5
365PLP-8M-10M	8	10	34.5
365PLP-10M-12M	10	12	40.5



### 364PLP Unequal Union Tee

PART NO.	1 TUBE SIZE MM	2 TUBE SIZE MM	H	L/2
364PLP-4M-6M	4	6	22.5	17.5
364PLP-6M-4M	6	4	22.5	17.5
364PLP-6M-8M	6	8	29.5	23.0
364PLP-8M-6M	8	6	29.5	23.0
364PLP-8M-10M	8	10	34.5	26.5
364PLP-10M-12M	10	12	34.5	26.5
364PLP-10M-8M	10	8	40.5	31.0
364PLP-12M-10M	12	10	40.5	31.0
364PLP-14M-8M	14	8	46.0	35.5
364PLP-16M-12M	16	12	39.0	

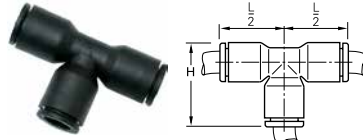

### 364PLP Union Tee

PART NO.	TUBE SIZE IN	L/2	H
364PLP-2	1/8	.57	.75
364PLP-3	3/16	.85	1.07
364PLP-4	1/4	.71	.92
364PLP-6	3/8	1.02	1.34
364PLP-8	1/2	1.38	1.81

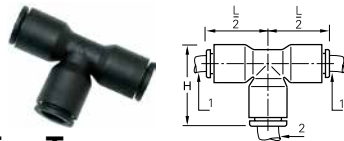

### 364PLP Unequal Union Tee

PART NO.	1 TUBE SIZE IN	2 TUBE SIZE IN	L/2	H
364PLP-2-4	1/8	1/4	.71	.93
364PLP-4M-4	5/32 (4MM)	1/4	.71	.93
364PLP-4-2	1/4	1/8	.73	.93
364PLP-4-4M	1/4	5/32 (4MM)	.73	.93
364PLP-4-6	1/4	3/8	.96	1.32
364PLP-6-4	3/8	1/4	1.00	1.28
364PLP-6-8	3/8	1/2	1.38	1.81
364PLP-8-4	1/2	1/4	1.38	1.81
364PLP-8-6	1/2	3/8	1.38	1.81

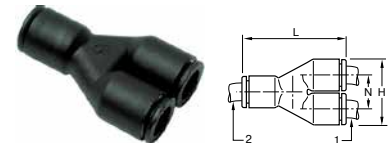

### 362PLP Union Y

PART NO.	1 TUBE SIZE IN	2 TUBE SIZE IN	L	H	N
362PLP-2	1/8	1/8	1.12	.69	.35
362PLP-2-4	1/8	1/4	1.42	.87	.45
362PLP-4M-4	5/32 (4MM)	1/4	1.42	.87	.45
362PLP-4	1/4	1/4	1.42	.87	.45
362PLP-4-6	1/4	3/8	2.02	1.30	.67
362PLP-6	3/8	3/8	2.09	1.30	.67
362PLP-8	1/2	1/2	2.64	1.77	.91

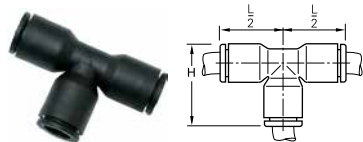

### 364PLP Union Tee

PART NO.	TUBE SIZE MM	H	L/2
364PLP-3M	3	19.0	14.5
364PLP-4M	4	19.0	14.5
364PLP-6M	6	23.5	18.0
364PLP-8M	8	29.5	23.0
364PLP-10M	10	34.5	26.5
364PLP-12M	12	40.5	31.0
364PLP-14M	14	46.0	35.5
364PLP-16M	16	52.0	39.0

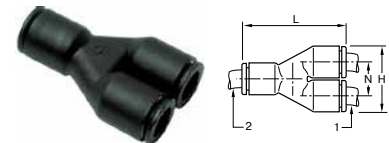

### 362PLP Union Y

PART NO.	1 TUBE SIZE MM	2 TUBE SIZE (M)	H	L	N
362PLP-4M	4	4	17.5	28.5	9.0
362PLP-6M	6	6	21.5	35.0	11.0
362PLP-8M	8	8	28.0	45.0	14.5
362PLP-10M	10	10	33.0	53.0	17.0
362PLP-12M	12	12	39.0	57.0	20.0
362PLP-4M-6M	4	6	17.5	33.0	9.0
362PLP-6M-8M	6	8	22.5	41.0	11.5
362PLP-8M-10M	8	10	28.0	47.0	14.5
362PLP-10M-12M	10	12	33.0	57.0	17.0

**WARNING** These products can expose you to chemicals including NICKEL, which is known to the state of California to cause cancer. For more information go to [www.P65Warnings.ca.gov](http://www.P65Warnings.ca.gov).



Click here for CADs, Product Specifications or to Configure Parts Online

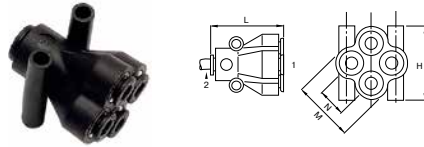

### 362PLPD Double Y Connector

PART NO.	1 TUBE SIZE IN	2 TUBE SIZE IN	H	L	M	N	MOUNTING HOLE DIA.
362PLPD-4M-4	5/32 (4MM)	1/4	1.00	1.18	.83	.39	.15

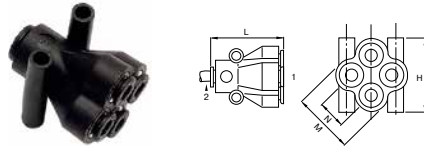

### 362PLPD Double Y Connector

PART NO.	1 TUBE SIZE MM	2 TUBE SIZE MM	H	L	M	N	MOUNTING HOLE DIA.
362PLPD-4M	4	4	25.5	30.5	21.0	10.0	3.7
362PLPD-6M	6	6	31.5	37.5	26.5	12.0	3.7
362PLPD-4M-6M	4	6	25.5	30.5	21.0	10.0	3.7
362PLPD-6M-8M	6	8	31.5	38.0	26.5	12.0	3.7



### 32PLPBH Bulkhead Union

PART NO.	TUBE SIZE IN	C HEX MM	K MAX	L1	L2	BULKHEAD THREAD	BULKHEAD HOLE DIA.
32PLPBH-2	1/8	13	.22	.37	.61	M10 X 1	12MM
32PLPBH-4	1/4	16	.35	.37	.81	M15 X 1	16MM
32PLPBH-6	3/8	22	.57	.51	1.18	M18 X 1.5	24MM
32PLPBH-8	1/2	29	.81	.67	1.61	M25 X 1.5	26MM



### 32PLPBH Bulkhead Union

PART NO.	TUBE SIZE MM	C HEX MM	K MAX	L1	L2	BULKHEAD THREAD	BULKHEAD HOLE DIA.
32PLPBH-4M	4	13	5.5	15.0	10.0	M12 X 1	12MM
32PLPBH-6M	6	15	8.5	18.0	10.5	M14 X 1	14MM
32PLPBH-8M	8	18	14.5	25.0	13.5	M16 X 1	16MM
32PLPBH-10M	10	22	14.5	27.5	15.5	M22 X 1.5	22MM
32PLPBH-12M	12	26	18.5	33.0	18.0	M24 X 1.5	24MM
32PLPBH-14M	14	29	20.5	37.5	20.5	M26 X 1.5	26MM



### 365PLPBH Equal Bulkhead Elbow

PART NO.	TUBE SIZE IN	C1 HEX	C2 HEX	K MAX	H	L	BULKHEAD THREAD	BHD HOLE DIA.
365PLPBH-2	1/8	13	13	.28	.71	.57	M10 X 1	10MM
365PLPBH-4M	5/32(4MM)		13	.26	.83	.67	M12 X 1	12MM
365PLPBH-4	1/4	18	17	.32	.87	.71	M15 X 1	15MM
365PLPBH-8M	5/16(8MM)		18	.31	1.22	.94	M16 X 1	16MM
365PLPBH-6	3/8	22	22	.33	1.08	1.00	M18 X 1.5	18MM
365PLPBH-8	1/2	29	27	.41	1.54	1.38	M25 X 1.5	25MM

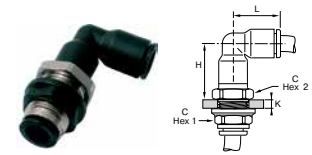

### 365PLPBH Equal Bulkhead Elbow

PART NO.	TUBE SIZE MM	C1 HEX	C2 HEX	K MAX	H	L	BULKHEAD THREAD	BULKHEAD HOLE DIA.
365PLPBH-4M	4	13	13	6.5	21.0	17.0	M12 X 1	12MM
365PLPBH-6M	6	15	15	7.0	24.5	19.5	M14 X 1	14MM
365PLPBH-8M	8	18	18	8.0	31.0	24.0	M16 X 1	16MM
365PLPBH-10M	10	22	22	8.5	36.0	28.0	M22 X 1.5	22MM
365PLPBH-12M	12	26	26	8.5	42.0	33.0	M24 X 1.5	24MM

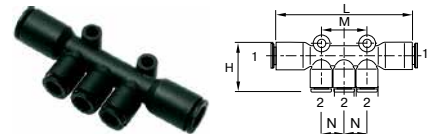

### 24PLP Multiple Tee

PART NO.	1 TUBE SIZE IN	2 TUBE SIZE IN	H	L	M	N	MTG HOLE DIA.
24PLP-4-4M	1/4	5/32(4MM)	0.97	2.81	.90	.45	.17
24PLP-4-4	1/4	1/4	1.22	3.14	1.21	.61	.17
24PLP-6-4	3/8	1/4	1.34	3.21	1.22	.61	.17

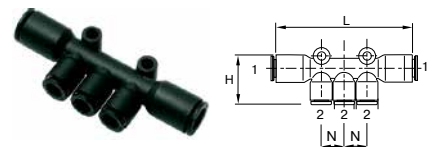

### 24PLP Multiple Tee

PART NO.	1 TUBE SIZE MM	2 TUBE SIZE (M)	H	L	N	MOUNTING HOLE DIA.
24PLP-6M-4M	6	4	24.5	74	11.5	4.2
24PLP-8M-4M	8	4	24.5	74	11.5	4.2
24PLP-8M-6M	8	6	24.5	74	11.5	4.2
24PLP-10M-6M	10	6	36.0	81	15.5	4.2
24PLP-10M-8M	10	8	36.0	81	15.5	4.2

**WARNING** These products can expose you to chemicals including NICKEL, which is known to the state of California to cause cancer. For more information go to [www.P65Warnings.ca.gov](http://www.P65Warnings.ca.gov).



Click here for CADs, Product Specifications or to Configure Parts Online

- A
- B
- C
- D
- E
- F
- G
- H
- I
- J
- K
- L
- M
- N
- O

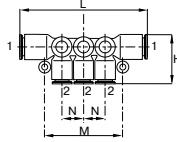

### 24PLPD Double Multiple Tee

PART NO.	1 TUBE SIZE IN	2 TUBE SIZE IN	H	L	M	N	MOUNTING HOLE DIA.
24PLPD-4-4M	1/4	5/32(4MM)	.73	2.84	1.69	.45	.17
24PLPD-4-4	1/4	1/4	.73	2.84	1.69	.45	.17
24PLPD-6-4	3/8	1/4	.91	3.31	2.05	.57	.17

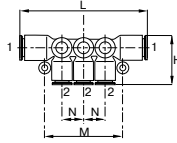

### 24PLPD Double Multiple Tee

PART NO.	1 TUBE SIZE MM	2 TUBE SIZE MM	H	L	M	N	MOUNTING HOLE DIA.
24PLPD-6M-4M	6	4	18.5	72.0	43.0	11.5	4.2
24PLPD-8M-4M	8	4	18.5	73.0	43.0	11.5	4.2
24PLPD-8M-6M	8	6	18.5	73.0	43.0	11.5	4.2
24PLPD-10M-6M	10	6	23.0	84.0	52.0	14.5	4.2
24PLPD-10M-8M	10	8	23.5	84.0	52.0	14.5	4.2

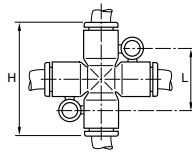

### 347PLP Equal Cross

PART NO.	TUBE SIZE IN	H	L	MOUNTING HOLE DIA.
347PLP-4	1/4	1.40	.79	.17

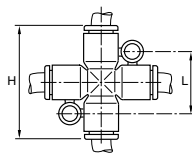

### 347PLP Equal Cross

PART NO.	TUBE SIZE MM	H	L	MOUNTING HOLE DIA.
347PLP-4M	4	36	20.0	4.2
347PLP-6M	6	36	20.0	4.2
347PLP-8M	8	46	22.5	4.2

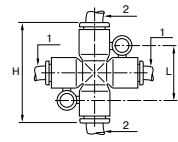

### 347PLP Unequal Cross

PART NO.	1 TUBE SIZE MM	2 TUBE SIZE MM	H	L	MOUNTING HOLE DIA.
347PLP-4M-6M	4	6	36	20.0	4.2
347PLP-6M-4M*	6	4	36	20.0	4.2
347PLP-6M-8M	6	8	46	22.5	4.2
347PLP-8M-6M*	8	6	46	22.5	4.2

\*This model provides 3 outlets of "TUBE1" and 1 outlet of "TUBE 2".

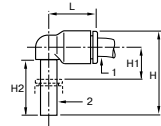

### 369PLPSP Plug-In Elbow

PART NO.	1 TUBE SIZE IN	2 TUBE SIZE IN	H	H1	H2	L
369PLPSP-2	1/8	1/8	.92	.31	.64	.57
369PLPSP-4M-4	5/32(4MM)	1/4	1.08	.30	.71	.71
369PLPSP-4	1/4	1/4	1.20	.43	.83	.73
369PLPSP-4-6	1/4	3/8	1.52	.35	.96	.98
369PLPSP-6	3/8	3/8	1.52	.35	.96	1.02
369PLPSP-8	1/2	1/2	2.00	.51	1.12	1.38

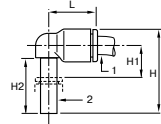

### 369PLPSP Plug-In Elbow

PART NO.	1 TUBE SIZE MM	2 TUBE SIZE MM	H	H1	H2	L
369PLPSP-4M	4	4	23.0	6.0	15.5	14.0
369PLPSP-6M	6	6	26.5	7.0	17.0	16.0
369PLPSP-8M	8	8	33.5	8.0	21.5	23.0
369PLPSP-10M	10	10	39.0	9.5	24.5	23.5
369PLPSP-12M	12	12	44.5	10.0	27.5	31.0
369PLPSP-4M-6M	4	6	26.5	7.0	17.0	16.0
369PLPSP-6M-4M	6	4	24.5	7.0	15.5	16.0
369PLPSP-6M-8M	6	8	33.5	8.0	21.5	22.0
369PLPSP-8M-10M	8	10	39.0	8.5	24.5	26.5
369PLPSP-10M-12M	10	12	44.5	10.0	27.5	31.0

**WARNING** These products can expose you to chemicals including NICKEL, which is known to the state of California to cause cancer. For more information go to [www.P65Warnings.ca.gov](http://www.P65Warnings.ca.gov).



[Click here for CADs, Product Specifications or to Configure Parts Online](#)



### 369PLPSPX Extended Plug-In Elbow

PART NO.	1 TUBE SIZE IN	2 TUBE SIZE IN	H	H1	H2	L
369PLPSPX-2	1/8	1/8	1.26	.65	.98	.57
369PLPSPX-4	1/4	1/4	1.56	.77	1.18	.71
369PLPSPX-6	3/8	3/8	2.19	1.02	1.63	1.02



### 369PLPSPX Extended Plug-In Elbow

PART NO.	1 TUBE SIZE MM	2 TUBE SIZE MM	H	H1	H2	L
369PLPSPX-4M	4	4	32.5	15.5	25.0	14.0
369PLPSPX-6M	6	6	38.5	19.0	29.0	16.0
369PLPSPX-8M	8	8	49.0	23.5	37.0	23.0
369PLPSPX-10M	10	10	56.0	26.5	41.5	26.5
369PLPSPX-12M	12	12	62.5	28.0	45.5	31.0
369PLPSPX-4M-6M	4	6	38.5	19.0	29.0	16.0
369PLPSPX-6M-8M	6	8	49.0	23.5	37.0	23.0
369PLPSPX-8M-10M	8	10	56.0	26.5	41.5	26.5
369PLPSPX-10M-12M	10	12	62.5	28.0	45.5	31.0

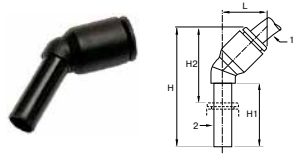

### 379PLPSP 45° Plug-In Elbow

PART NO.	1 TUBE SIZE IN	2 TUBE SIZE IN	H	H1	H2	L
379PLPSP-2	1/8	1/8	1.14	.59	.69	.47
379PLPSP-4	1/4	1/4	1.44	.71	.87	.57
379PLPSP-6	3/8	3/8	2.00	.96	1.16	.91

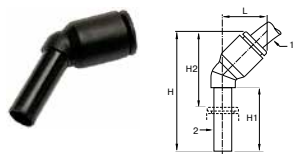

### 379PLPSP 45° Plug-In Elbow

PART NO.	1 TUBE SIZE MM	2 TUBE SIZE MM	H	H1	H2	L
379PLPSP-4M	4	4	33.5	19.0	21.0	13.0
379PLPSP-6M	6	6	39.0	21.0	25.0	14.5
379PLPSP-8M	8	8	44.0	21.5	25.5	19.5
379PLPSP-10M	10	10	53.0	27.0	32.5	23.0
379PLPSP-12M	12	12	58.5	27.5	34.0	26.5

**WARNING** These products can expose you to chemicals including NICKEL, which is known to the state of California to cause cancer. For more information go to [www.P65Warnings.ca.gov](http://www.P65Warnings.ca.gov).



### 372PLPSP Plug-In Branch Tee

PART NO.	1 TUBE SIZE IN	2 TUBE SIZE IN	H	H1	H2	L/2
372PLPSP-2	1/8	1/8	.95	.26	.59	.57
372PLPSP-4	1/4	1/4	.98	.43	.77	.73
372PLPSP-6	3/8	3/8	1.61	.35	.96	.98
372PLPSP-8	1/2	1/2	2.01	.51	1.12	1.38

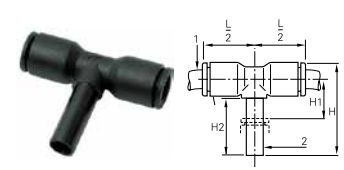

### 372PLPSP Plug-In Branch Tee

PART NO.	1 TUBE SIZE MM	2 TUBE SIZE MM	H	H1	H2	L/2
372PLPSP-4M	4	4	23.0	6.0	15.5	14.5
372PLPSP-6M	6	6	26.5	7.0	17.0	16.0
372PLPSP-8M	8	8	33.5	8.0	21.5	23.0
372PLPSP-10M	10	10	39.0	9.5	24.5	26.5
372PLPSP-12M	12	12	44.5	10.0	27.5	31.0
372PLPSP-4M-6M	4	6	26.5	7.0	17.0	16.0
372PLPSP-6M-8M	6	8	33.5	8.0	21.5	23.0
372PLPSP-8M-10M	8	10	39.0	9.5	24.5	26.5
372PLPSP-10M-12M	10	12	44.5	10.0	27.5	31.0

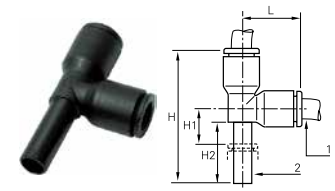

### 371PLPSP Plug-In Run Tee

PART NO.	1 TUBE SIZE IN	2 TUBE SIZE IN	H	H1	H2	L
371PLPSP-4	1/4	1/4	1.69	.43	.83	.73
371PLPSP-6	3/8	3/8	2.23	.33	.96	1.00
371PLPSP-8	1/2	1/2	2.86	.51	1.12	1.38



[Click here for CADs, Product Specifications or to Configure Parts Online](#)

- A
- B
- C
- D
- E
- F
- G
- H
- I
- J
- K
- L
- M
- N
- O

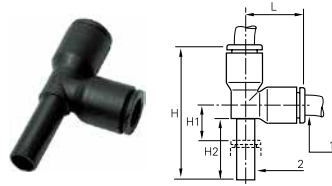

### 371PLPSP Plug-In Run Tee

PART NO.	1 TUBE SIZE MM	2 TUBE SIZE MM	H	H1	H2	L
371PLPSP-4M	4	4	33.0	6.0	15.5	14.5
371PLPSP-6M	6	6	38.5	7.0	17.0	17.5
371PLPSP-8M	8	8	49.0	8.0	21.5	23.0
371PLPSP-10M	10	10	57.0	10.5	24.5	26.5
371PLPSP-12M	12	12	65.5	10.5	27.5	31.0
371PLPSP-4M-6M	4	6	10.5	7.0	17.0	17.5
371PLPSP-6M-8M	6	8	13.5	8.0	21.5	23.0
371PLPSP-8M-10M	8	10	16.0	10.5	24.5	26.5
371PLPSP-10M-12M	10	12	19.0	10.5	27.5	31.0

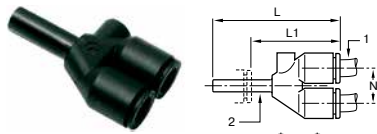

### 362PLPSP Plug-In Y

PART NO.	1 TUBE SIZE IN	2 TUBE SIZE IN	L	L1	N
362PLPSP-2	1/8	1/8	1.36	1.00	.35
362PLPSP-4	1/4	1/4	1.60	1.02	.45
362PLPSP-6	3/8	3/8	2.23	1.42	.67

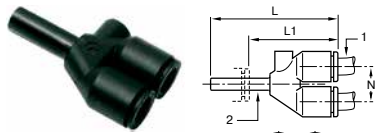

### 362PLPSP Plug-In Y

PART NO.	1 TUBE SIZE MM	2 TUBE SIZE MM	L	L1	N
362PLPSP-4M	4	4	34.0	21.5	9.0
362PLPSP-6M	6	6	39.5	25.5	11.0
362PLPSP-8M	8	8	50.5	32.0	14.5
362PLPSP-10M	10	10	57.5	36.0	17.0
362PLPSP-12M	12	12	66.0	41.0	20.0
362PLPSP-4M-6M	4	6	35.5	21.5	9.0
362PLPSP-6M-8M	6	8	44.0	25.5	11.0
362PLPSP-8M-10M	8	10	53.5	32.0	14.5
362PLPSP-10M-12M	10	12	60.0	35.0	17.0

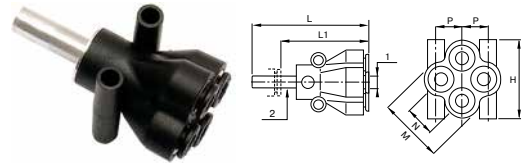

### 362PLPDSP Plug-In Multiple Y

PART NO.	1 TUBE SIZE MM	2 TUBE SIZE MM	H	L	L1	M	N
362PLPDSP-4M-6M	4	6	25.5	45.0	31.0	21.0	10.0
362PLPDSP-4M-8M	4	8	25.5	49.5	31.0	21.0	10.0
362PLPDSP-6M-8M	6	8	31.5	59.5	41.0	26.5	12.0

\*Aluminum tail piece

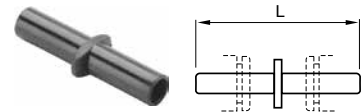

### 63PLP Double Male Union

PART NO.	TUBE SIZE IN	L
63PLP-4	1/4	1.52
63PLP-6	3/8	2.03

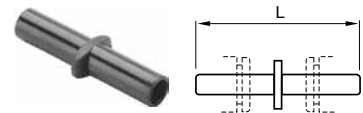

### 63PLP Double Male Union

PART NO.	TUBE SIZE MM	L
63PLP-4M	4	34 1/2
63PLP-6M	6	38 1/2
63PLP-8M	8	41
63PLP-10M	10	51 1/2
63PLP-12M	12	60
63PLP-14M	14	69 1/2

**WARNING** These products can expose you to chemicals including NICKEL, which is known to the state of California to cause cancer. For more information go to [www.P65Warnings.ca.gov](http://www.P65Warnings.ca.gov).



Click here for CADs, Product Specifications or to Configure Parts Online



### 37PLP Tube Reducer

PART NO.	1 TUBE SIZE IN	2 TUBE SIZE IN	L	L1
37PLP-2-4M	1/8	5/32 (4M)	1.79	1.32
37PLP-2-3	1/8	3/16	1.79	1.14
37PLP-2-4	1/8	1/4	1.79	1.22
37PLP-4M-3	5/32 (4MM)	3/16	1.48	.83
37PLP-4M-4	5/32 (4MM)	1/4	1.48	.91
37PLP-4M-6	5/32 (4MM)	3/8	1.61	.81
37PLP-3-8M	3/16	5/16 (8M)	1.79	1.06
37PLP-3-4	3/16	1/4	1.79	1.22
37PLP-4-8M	1/4	5/16 (8M)	1.61	.89
37PLP-4-6	1/4	3/8	1.61	.81
37PLP-4-8	1/4	1/2	1.97	.98
37PLP-8M-6	5/16 (8MM)	3/8	1.93	1.12
37PLP-8M-8	5/16 (8MM)	1/2	2.01	1.02
37PLP-6-8	3/8	1/2	2.01	1.04



### 37PLP Tube Reducer

PART NO.	1 TUBE SIZE MM	2 TUBE SIZE MM	L	L1
37PLP-4M-6M	4	6	37.5	23.5
37PLP-4M-8M	4	8	37.5	19.0
37PLP-6M-8M	6	8	36.0	20.5
37PLP-4M-10M	4	10	44.0	22.5
37PLP-6M-10M	6	10	38.0	17.5
37PLP-8M-10M	8	10	49.0	28.5
37PLP-10M-12M	10	12	56.5	33.5
37PLP-6M-12M	6	12	46.0	23.0
37PLP-8M-12M	8	12	49.0	24.5
37PLP-10M-14M	10	14	58.5	33.5
37PLP-12M-14M	12	14	58.5	33.5
37PLP-6M-14M	6	14	48.0	23.0
37PLP-8M-14M	8	14	48.0	23.0

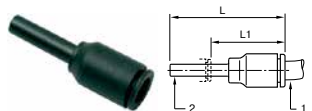

### 32PLPSP Tube Expander

PART NO.	1 TUBE SIZE IN	2 TUBE SIZE IN	L	L1
32PLPSP-4-2	1/4	1/8	1.61	1.16
32PLPSP-4-6M	1/4	6M	1.75	1.02
32PLPSP-4-4M	1/4	5/32 (4M)	1.61	1.14
32PLPSP-4-3	1/4	3/16	1.61	1.00
32PLPSP-6-4	3/8	1/4	1.58	1.00



### 32PLPSP Tube Expander

PART NO.	1 TUBE SIZE MM	2 TUBE SIZE MM	L	L1
32PLPSP-6M-4M	6	4	35.0	23.0
32PLPSP-8M-6M	8	6	45.0	31.5
32PLPSP-10M-8M	10	8	42.5	21.0
32PLPSP-12M-10M	12	10	49.0	24.5



### 32PLPSP Tube Converter

PART NO.	1 TUBE SIZE MM	2 TUBE SIZE IN	L	L1
32PLPSP-4M-2	4M	1/8	1.61	1.16
32PLPSP-8M-4	8M	1/4	1.58	1.00

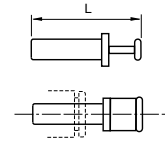

### 639PLP Plug Inch

PART NO.	TUBE SIZE	L
639PLP-2	1/8	1.30
639PLP-3	3/16	1.36
639PLP-4	1/4	1.44
639PLP-6	3/8	1.67
639PLP-8	1/2	1.91

### 639PLP Plug Metric

PART NO.	TUBE SIZE	L
639PLP-3M	3	25
639PLP-4M	4	30
639PLP-6M	6	33
639PLP-8M	8	33
639PLP-10M	10	42
639PLP-12M	12	45
639PLP-14M	14	49
639PLP-16M*	16	57

\* Nickel Plated Brass

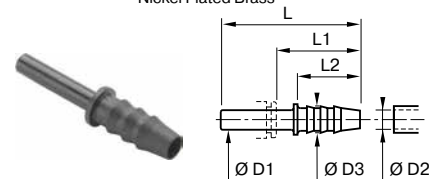

### 322PLPSP Barbed Connector

PART NO.	OD 1	OD 2	OD 3	L	L1	L2
322PLPSP-4M-2	5/32(4MM)	.120	.20	1.46	.98	.67
322PLPSP-4M-5M	5/32(4MM)	.200	.28	1.46	.98	.67
322PLPSP-4-3*	1/4	3/16		1.65	1.00	
322PLPSP-8M-4	5/16(8MM)	.250	.34	1.55	.83	.67
322PLPSP-8M-8M	5/16(8MM)	.320	.39	1.75	1.02	.87
322PLPSP-6-8M	3/8	.320	.39	1.97	1.16	.87
322PLPSP-8-6*	1/2	.375	.57	2.28	1.34	.87

\*Nickel-plated brass. Dimensions for OD2 are I.D. of the tube.

**WARNING** These products can expose you to chemicals including NICKEL, which is known to the state of California to cause cancer. For more information go to [www.P65Warnings.ca.gov](http://www.P65Warnings.ca.gov).



[Click here for CADs, Product Specifications or to Configure Parts Online](#)

A

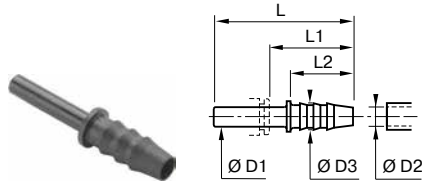

### 322PLPSP Barbed Connector

PART NO.	OD 1	OD 2	OD 3	L	L1	L2
322PLPSP-4M-3M	4	3.2	5.0	37.0	25.0	17.0
322PLPSP-4M-5M	4	5.0	7.0	37.0	25.0	17.0
322PLPSP-6M-5M	6	5.0	7.0	39.0	25.0	17.0
322PLPSP-8M-6M	8	6.3	8.5	39.5	21.0	17.0
322PLPSP-8M-8M	8	8.0	10.0	44.5	26.0	22.0
322PLPSP-10M-6M	10	6.3	8.0	45.0	24.5	17.0
322PLPSP-10M-8M	10	8.0	10.0	50.0	29.5	22.0
322PLPSP-12M-8M	12	8.0	10.0	50.0	26.0	22.0
322PLPSP-12M-10M	12	10.0	12.0	48.5	25.5	22.5
322PLPSP-12M-12M	12	12.5	14.5	57.0	34.0	22.5
322PLPSP-14M-12M	14	12.5	14.5	59.5	34.5	22.5

\*Nickel-plated brass. Dimensions for OD2 are I.D. of the tube.

B

C

D

E

F

G

H

I

J

K

L

M

N

O

### 32PLPDRC Connector for 3 Tubes

PART NO.	TUBE SIZE MM	H	K	L	N
32PLPDRC-4M	4	36.5	11.0	39.5	
32PLPDRC-6M	6	36.5	11.0	39.5	
32PLPDRC-8M	8	46.0	13.0	14.5	

### Clip Strips for Tubing and Fittings

PART NO.	D TUBE	LF3000 TO BE CLIPPED	H MM	K MM	N MM	NO. PER STRIP
CLIP 04 00	5/32, 4MM	-	9	13.5	10.5	8
CLIP 06 00	1/4, 3/16, 6MM	-	10.5	13	10.5	8
CLIP 08 00	5/16, 8MM	5/32, 4MM	12.5	10.5	12	7
CLIP 10 00	3/8, 10MM	1/4, 6MM	14	12	15	6
CLIP 12 00	1/2, 12MM		16.5	14	16.5	5
CLIP 14 00	14MM	5/16, 8MM	18	16	20.5	4

Clip strips come complete with screws of .512 inches in length.

### 32PLPRC Connector for 2 Tubes

PART NO.	TUBE SIZE IN	H	K	L
32PLPRC-4	1/4	1.44	.47	1.18

### 32PLPRC Connector for 2 Tubes

PART NO.	TUBE SIZE MM	H	K	L
32PLPRC-4M	4	36.5	11.0	39.5
32PLPRC-6M	6	36.5	11.0	39.5
32PLPRC-8M	8	46.0	13.0	44.5

### 3151 End Caps

PART NO.	D IN	G MM	H MM
3151 53 00	1/8	.33	.55
3151 04 00	5/32	.33	.55
3151 56 00	1/4	.41	.64
3151 08 00	5/16	.53	.86
3151 60 00	3/8	.53	.86

### 3151 End Caps

PART NO.	D MM	G MM	H MM
3151 04 00	4	8.5	14.7
3151 06 00	6	10.5	16.9
3151 08 00	8	13.5	21.9
3151 10 00	10	16	22.2
3151 12 00	12	19	27.7

**WARNING** These products can expose you to chemicals including NICKEL, which is known to the state of California to cause cancer. For more information go to [www.P65Warnings.ca.gov](http://www.P65Warnings.ca.gov).





[Click here for CADs, Product Specifications or to Configure Parts Online](#)

- A
- B
- C
- D
- E
- F
- G
- H
- I
- J
- K
- L
- M
- N
- O

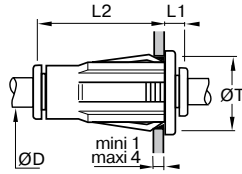

### 32PLPBHP Plug-in Bulkhead Union

PART NO.	TUBE SIZE IN	L1	L2	ØT
32PLPBHP-4	1/4	.26	1.240	.75
32PLPBHP-8M	5/16 (8MM)	.30	1.280	.87
32PLPBHP-6	3/8	.30	1.630	1.12

Minimum distance between fittings.  
Diameter of fixing hole.

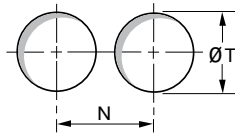

### Fixing Hole

D	5/32	1/4	5/16	3/8	1/2
T inches	5/8"	3/4"	7/8"	1 1/8"	1 1/4"
T mm	15.87	19.05	22.22	28.57	31.75
N in	.89	1.00	1.08	1.34	1.50

Tolerance T: +0.3 -0.1

### Installation

1. Mark out the fixing hole
2. Make hole in panel
3. Simply push the fitting into place
4. To complete the installation
5. To identify circuits simply remove the black release button and replace with colored one

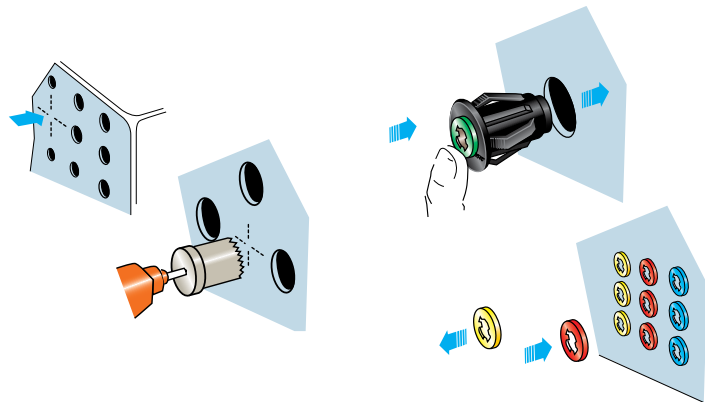

### AQRT - Quick Release Tool

Makes disconnection of tube adapters and tubing a breeze.



### 3110 - 3330 Caps Manual Release Button - Inch

TUBE O.D.	WHITE PART NO.	BLACK PART NO.	GREEN PART NO.	RED PART NO.	BLUE PART NO.	YELLOW PART NO.
1/8	3110 53 00	-	3110 53 02	3110 53 03	3110 53 04	3110 53 05
5/32	3110 04 00	3330 04 01	3110 04 02	3110 04 03	3110 04 04	3110 04 05
3/16	3330 55 00	3330 55 01	3330 55 02	3330 55 03	3330 55 04	3330 55 05
1/4	3110 56 00	3330 56 01	3110 56 02	3110 56 03	3110 56 04	3110 56 05
5/16	3110 08 00	-	3110 08 02	3110 08 03	3110 08 04	3110 08 05
3/8	3110 60 00	-	-	-	3110 60 04	3110 60 05
1/2	3110 62 00	3330 62 01	3110 62 02	3110 62 03	3110 62 04	3110 62 05



### 3110 - 3330 Caps Manual Release Button - Metric

TUBE MM	WHITE PART NO.	BLACK PART NO.	GREEN PART NO.	RED PART NO.	BLUE PART NO.	YELLOW PART NO.
4	3110 04 00	3330 04 01	3110 04 02	3110 04 03	3110 04 04	3110 04 05
6	3110 06 00	3330 06 01	3110 06 02	3110 06 03	3110 06 04	3110 06 05
8	3110 08 00	-	3110 08 02	3110 08 03	3110 08 04	3110 08 05
10	3110 10 00	-	3110 10 02	3110 10 03	3110 10 04	3110 10 05
12	3110 12 00	-	3110 12 02	3110 12 03	3110 12 04	3110 12 05
14	3110 14 00	-	3110 14 02	3110 14 03	3110 14 04	3110 14 05

In all sizes of the LF3000 fittings, except 3/16, the push button is an integral part of the design which makes it non-removable, and comes standard in black. For identification of the circuits, colored caps (p/n 3110) fit over the black push button.

On the 3/16 sizes, the buttons are removable and can be replaced with a button of another color (p/n 3330).

Six colors are available which allow color coding of the fitting, in association with tubes of the same color.

**WARNING** These products can expose you to chemicals including NICKEL, which is known to the state of California to cause cancer. For more information go to [www.P65Warnings.ca.gov](http://www.P65Warnings.ca.gov).



A

B

C

D

E

F

G

H

I

J

K

L

M

N

O



# Oscillating Elbows

Parker's oscillating fittings are designed to satisfy the requirements of industrial automation and robotics. The oscillating fitting features low-friction washers enabling the fitting to rotate in conjunction with the stroke of the cylinder piston.

## Product Features:

- Glass reinforced nylon 6.6 body
- Nylon collar
- Stainless Steel gripping ring
- Nitrile D seal
- Nitrile o-ring
- Nickel-plated brass threads

## Markets:

- Robotics
- Pneumatics
- Textile
- Packaging
- Semi-conductors

## Applications:

- Air
- Cutting Fluids
- Inert Gases

## Specifications:

**Pressure Range** Up to 290 PSI (19.9 bar)  
depending on tubing

**Temperature Range** -4° to +175° F (-20° to +79.4° C)

## Compatible Tubing:

- Semi-rigid nylon
- Polyurethane 95 Durometer Shore A
- Nylon
- Fluoropolymer

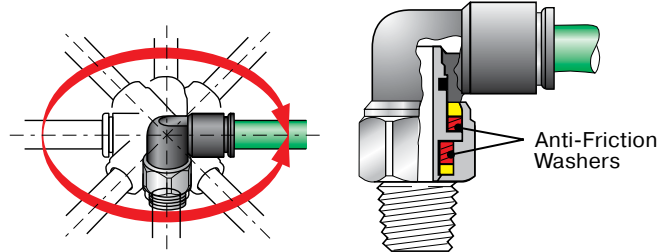

O.D. TUBE INCH & MM	5/32 & 4	1/4 & 6	8	10	12
"MAXIMUM ROTATION SPEED IN RADIAN/SECOND"	190	160	120	90	80

## Assembly Instructions

1. Cut tubing squarely – maximum of 15° angle allowable.
2. Check that port or mating part is clean and free of debris.
3. Mark tubing to appropriate tube insertion length. (see Tube Insertion Chart on page N22)
4. Insert tubing until it bottoms
5. Pull on tubing to verify it is fully inserted
6. To disassemble, simply press release button, hold against body and pull tubing out of fitting.

**WARNING** These products can expose you to chemicals including LEAD which is known to the state of California to cause cancer and birth defects or other reproductive harm. For more information go to [www.P65Warnings.ca.gov](http://www.P65Warnings.ca.gov).



Click here for CADs, Product Specifications or to Configure Parts Online

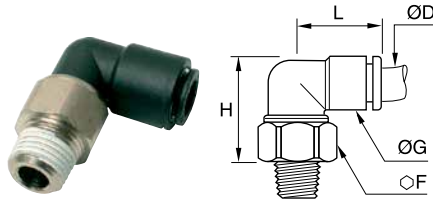

**W369PLPO Oscillating Compact Elbow - NPT**

PART NO.	TUBE SIZE IN	NPT	F	G	H	L
W369PLPO-4M-2	5/32(4MM)	1/8	12	.43	.85	.69
W369PLPO-4-2	1/4	1/8	14	.55	1.04	.81
W369PLPO-4-4	1/4	1/4	14	.55	1.04	.81

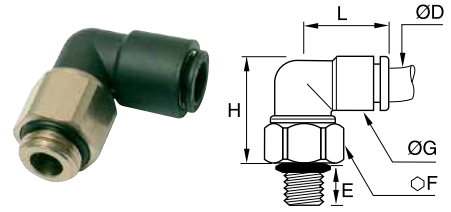

**369PLPO Oscillating Compact Elbow - BSPP, M5**

PART NO.	TUBE SIZE MM	M5/BSPP	E	F	G	H	L
369PLPO-4M-M5	4	M5X0.8	3.0	12	11.0	24.5	17.5
369PLPO-4M-2G	4	1/8	5.0	13	11.0	23.0	17.5
369PLPO-6M-M5	6	M5X0.8	3.0	12	14.0	27.5	20.5
369PLPO-6M-2G	6	1/8	5.0	14	14.0	27.0	20.5
369PLPO-6M-4G	6	1/4	5.5	16	14.0	25.5	20.5
369PLPO-8M-2G	8	1/8	5.0	17	16.0	33.5	23.5
369PLPO-8M-4G	8	1/4	5.5	17	16.0	31.0	23.5
369PLPO-8M-6G	8	3/8	5.5	20	16.0	29.5	23.5
369PLPO-10M-4G	10	1/4	5.5	19	19.5	50.0	29.0
369PLPO-10M-6G	10	3/8	5.5	20	19.5	37.0	29.0
369PLPO-12M-4G	12	1/4	5.5	21	22.0	46.5	33.5
369PLPO-12M-6G	12	3/8	5.5	21	22.0	45.5	33.5

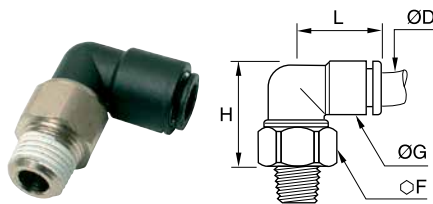

**W369PLPO Oscillating Compact Elbow - BSPT**

PART NO.	TUBE SIZE MM	BSPT	F	G	H	L
W369PLPO-4M-2R	4	1/8	12	11.0	22.0	17.5
W369PLPO-6M-2R	6	1/8	14	14.0	26.5	20.5
W369PLPO-6M-4R	6	1/4	14	14.0	23.5	20.5
W369PLPO-8M-2R	8	1/8	17	16.0	32.0	23.5
W369PLPO-8M-4R	8	1/4	17	16.0	29.0	23.5
W369PLPO-8M-6R	8	3/8	17	16.0	25.0	23.5
W369PLPO-10M-4R	10	1/4	19	19.5	37.5	29.0
W369PLPO-10M-6R	10	3/8	19	19.5	33.5	29.0
W369PLPO-12M-4R	12	1/4	21	22.0	44.5	33.5
W369PLPO-12M-6R	12	3/8	21	22.0	41.0	33.5

**WARNING** These products can expose you to chemicals including LEAD which is known to the state of California to cause cancer and birth defects or other reproductive harm. For more information go to [www.P65Warnings.ca.gov](http://www.P65Warnings.ca.gov).



- A
- B
- C
- D
- E
- F
- G
- H
- I
- J
- K
- L
- M
- N
- O

A

B

C

D

E

F

G

H

I

J

K

L

M

N

O



# Prestolok PLM Metal Push-to-Connect Fittings

To meet your technical and environment requirements, Parker's Prestolok PLM fittings offers the robustness, reliability and resistance to industrial fluids for the most demanding environments.

## Product Features:

- High phosphorous, FDA-compliant, chemical resistant, nickel-plated collet and body
- FKM seal
- Chemical, corrosion, and abrasion resistance
- NPT, BSPT, BSPP, and metric threads
- Silicone Free

## Markets:

- Industrial
- Chemical
- Life Science
- Automation
- Food Processing

## Compatible Media:

- Food Fluids
- Harsh Detergents
- Cleaning In Cold/Hot Water
- Steam
- Oils
- Compressed Air
- Inert Gases

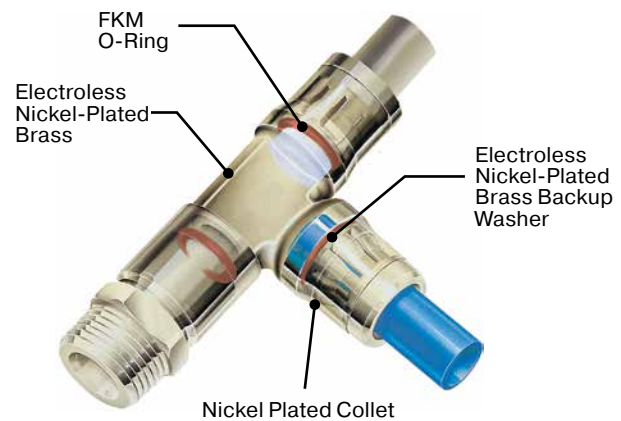

## Specifications:

**Pressure Range** Up to 435 psi (30 bar)  
290 psi (19.9 bar) for 169PLM

**Temperature Range** -13° to +302° F (-25° to +150° C)

**Vacuum Rating** 28" Hg

Note: Maximum pressure and temperature range depend on the type of tubing used.

## Compatible Tubing:

- Polyethylene
- Polyurethane 95 Durometer Shore A
- FEP
- Nylon

## Assembly Instructions

1. Cut tubing squarely maximum of 15° angle allowable.
2. Check that port or mating part is clean and free of debris.
3. Mark tubing to appropriate tube insertion length. (see Tube Insertion Chart on page N22)
4. Insert tubing until it bottoms
5. Pull on tubing to verify it is fully inserted
6. To disassemble, simply press release button, hold against body and pull tubing out of fitting.

**WARNING** These products can expose you to chemicals including LEAD which is known to the state of California to cause cancer and birth defects or other reproductive harm. For more information go to [www.P65Warnings.ca.gov](http://www.P65Warnings.ca.gov).



■ Threaded Fittings

**68PLM**

Male Connector  
NPT, BSPT  
p. A46



**68PLM**

Male Connector  
BSPP  
p. A46



**66PLM**

Female Connector  
BSPP  
p. A46



**68PLMSP**

Male Standpipe  
to BSPT  
p. A47



**68PLMSP**

Male Standpipe  
to BSPP  
p. A47



**169PLM**

Male Elbow  
NPT, BSPT  
p. A47



**169PLM**

Male Elbow  
BSPP  
p. A48



**169PLMX**

Extended Male  
Elbow – BSPT  
p. A48



**169PLMX**

Extended Male  
Elbow – BSPP  
p. A48



**171PLM**

Male Run Tee  
NPT, BSPT  
p. A48, A49



**171PLM**

Male Run Tee  
BSPP  
p. A49



**172PLM**

Male Branch Tee  
NPT, BSPT  
p. A49



**172PLM**

Male Branch Tee  
BSPP  
p. A50



■ Tube to Tube Fittings

**62PLM**

Union  
p. A50



**165PLM**

Union Elbow  
p. A51



**164PLM**

Union Tee  
p. A51



■ Bulkhead Unions

**62PLMBH**

Bulkhead Union  
p. A50



**66PLMBH**

Female Bulkhead  
p. A50



**165PLMBH**

Bulkhead Union  
p. A51



■ Modular Fittings

**169PLMBJ**

Single Banjo  
p. A52



■ Plug-In Fittings & Accessories

**67PLM**

Tube Reducer  
p. A51



**639PLM**

Plug  
p. A52



**PLMC**

Cartridge  
p. A52



**62PLMSP**

Tube Expander  
p. A52



**62PLMSP**

Tube Converter  
p. A52



**122PLMSP**

Barbed Connector  
p. A52



**63PLM**

Double Male Union  
p. A52



**WARNING** These products can expose you to chemicals including LEAD which is known to the state of California to cause cancer and birth defects or other reproductive harm. For more information go to [www.P65Warnings.ca.gov](http://www.P65Warnings.ca.gov).



[Click here for CADs, Product Specifications or to Configure Parts Online](#)

- A
- B
- C
- D
- E
- F
- G
- H
- I
- J
- K
- L
- M
- N
- O

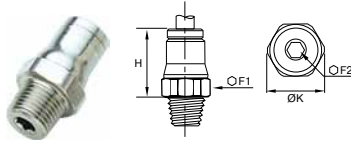

### 68PLM Male Connector Inch Tube to NPT/UNF

PART NO.	TUBE SIZE IN	NPT/UNF	F1 MM	F2 MM	H IN	K IN
68PLM-4M-0	5/32(4MM)	10-32	10	2.5	.61	.43
68PLM-4M-2	5/32(4MM)	1/8	11	3.0	.59	.47
68PLM-4M-4	5/32(4MM)	1/4	14	3.0	.59	.59
68PLM-4-0	1/4	10-32	13	2.5	.75	.55
68PLM-4-2	1/4	1/8	13	4.0	.67	.55
68PLM-4-4	1/4	1/4	14	4.0	.67	.59
68PLM-4-6	1/4	3/8	18	5.0	.67	.77
68PLM-6-2	3/8	1/8	18	4.0	.97	.77
68PLM-6-4	3/8	1/4	18	7.0	.95	.77
68PLM-6-6	3/8	3/8	18	8.0	.91	.77
68PLM-6-8	3/8	1/2	22	8.0	.95	.94
68PLM-8-6	1/2	3/8	22	9.0	.95	.94
68PLM-8-8	1/2	1/2	22	10.0	.95	.94

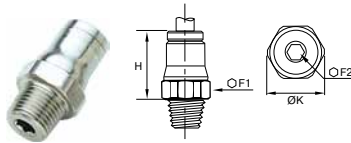

### 68PLM Male Connector Metric Tube to BSPT

PART NO.	TUBE SIZE MM	BSPT	F1 MM	F2 MM	H MM	K MM
68PLM-4M-2R	4	1/8	10	3	15.00	11.00
68PLM-4M-4R	4	1/4	14	3	15.00	15.00
68PLM-6M-2R	6	1/8	13	4	17.00	14.00
68PLM-6M-4R	6	1/4	14	4	17.00	15.00
68PLM-8M-2R	8	1/8	15	5	19.00	16.00
68PLM-8M-4R	8	1/4	15	6	18.00	16.00
68PLM-8M-6R	8	3/8	17	6	18.50	18.50
68PLM-10M-4R	10	1/4	18	7	23.00	19.50
68PLM-10M-6R	10	3/8	18	8	22.50	19.50
68PLM-10M-8R	10	1/2	22	8	22.50	24.00
68PLM-12M-4R	12	1/4	20	7	25.50	22.00
68PLM-12M-6R	12	3/8	20	9	24.00	22.00
68PLM-12M-8R	12	1/2	22	10	23.00	24.00
68PLM-14M-6R	14	3/8	22	9	27.00	24.00
68PLM-14M-8R	14	1/2	24	11	26.00	26.00

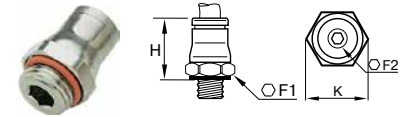

### 68PLM Male Connector Tube to UNF, BSPP or Metric

PART NO.	TUBE SIZE MM	BSPP/METRIC	F1 MM	F2 MM	H MM	K MM
68PLM-4M-M5	4	M5X0.8	10	2.50	15.50	11.00
68PLM-4M-M6	4	M6X1	13	3.00	14.50	14.00
68PLM-4M-2G	4	1/8	10	3.00	16.00	11.00
68PLM-4M-4G	4	1/4	16	3.00	14.50	17.50
68PLM-4M-M8	4	M8X1	11	3.00	14.50	12.00
68PLM-6M-M5	6	M5X0.8	13	2.50	19.00	14.00
68PLM-6M-2G	6	1/8	13	4.00	17.50	14.00
68PLM-6M-M10	6	M10X1	13	4.00	17.50	14.00
68PLM-6M-4G	6	1/4	16	4.00	17.00	17.50
68PLM-8M-2G	8	1/8	15	5.00	20.00	16.00
68PLM-8M-4G	8	1/4	16	6.00	18.00	17.50
68PLM-8M-6G	8	3/8	20	6.00	19.00	22.00
68PLM-10M-4G	10	1/4	18	7.00	25.00	19.50
68PLM-10M-6G	10	3/8	20	8.00	22.50	22.00
68PLM-10M-8G	10	1/2	24	8.00	22.50	26.00
68PLM-12M-4G	12	1/4	20	7.00	27.00	22.00
68PLM-12M-6G	12	3/8	20	9.00	26.00	22.00
68PLM-12M-8G	12	1/2	24	10.00	23.50	26.00
68PLM-14M-6G	14	3/8	22	9.00	28.00	24.00
68PLM-14M-8G	14	1/2	24	11.00	26.50	26.00

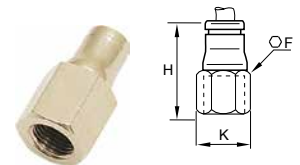

### 66PLM Female Connector Metric Tube to BSPP or M5

PART NO.	TUBE SIZE MM	BSPP/M5	F MM	H MM	K MM
66PLM-4M-M5	4	M5X0.8	10	22.00	11.00
66PLM-4M-2G	4	1/8	14	25.00	15.00
66PLM-4M-4G	4	1/4	17	29.00	18.50
66PLM-6M-2G	6	1/8	14	27.50	15.00
66PLM-6M-4G	6	1/4	17	31.50	18.50
66PLM8M-2G	8	1/8	15	28.50	16.00
66PLM-8M-4G	8	1/4	17	32.50	18.50
66PLM-10M-6G	10	3/8	22	38.00	24.00
66PLM-12M-6G	12	3/8	22	39.00	24.00
66PLM-12M-8G	12	1/2	24	43.50	26.00

**WARNING** These products can expose you to chemicals including LEAD which is known to the state of California to cause cancer and birth defects or other reproductive harm. For more information go to [www.P65Warnings.ca.gov](http://www.P65Warnings.ca.gov).



[Click here for CADs, Product Specifications or to Configure Parts Online](#)

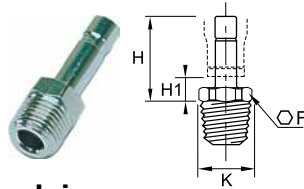

**68PLMSP Male Stud Standpipe Metric Tube to BSPT**

PART NO.	TUBE SIZE MM	BSPT	F MM	H MM	H1 MM	K MM
68PLMSP-4M-2R	4	1/8	10	21.00	7.00	11.00
68PLMSP-6M-2R	6	1/8	10	23.50	6.50	11.00
68PLMSP-6M-4R	6	1/4	10	23.50	6.50	15.00
68PLMSP-8M-2R	8	1/8	10	24.00	6.50	11.00
68PLMSP-8M-4R	8	1/4	14	24.00	6.50	15.00
68PLMSP-10M-4R	10	1/4	14	22.00	6.50	15.00
68PLMSP-10M-6R	10	3/8	17	30.00	7.50	18.50
68PLMSP-12M-6R	12	3/8	17	31.00	7.50	18.50
68PLMSP-12M-8R	12	1/2	22	38.00	7.50	24.00
68PLMSP-14M-8R	14	1/2	22	33.00	8.00	24.00

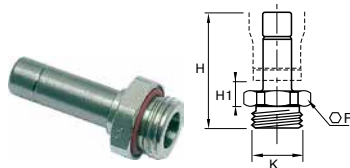

**68PLMSP Male Standpipe Metric Tube to BSPP or M5**

PART NO.	TUBE SIZE MM	BSPP/M5	F MM	H MM	H1 MM	K MM
68PLMSP-4M-M5	4	M5X0.8	13	25.50	7.00	14.00
68PLMSP-4M-2G	4	1/8	16	26.50	7.00	17.50
68PLMSP-4M-4G	4	1/4	8	25.00	7.50	8.70
68PLMSP-6M-2G	6	1/8	13	28.00	6.50	14.00
68PLMSP-6M-4G	6	1/4	16	29.00	6.50	17.50
68PLMSP-8M-2G	8	1/8	13	28.50	6.50	14.00
68PLMSP-8M-4G	8	1/4	16	29.50	6.50	17.50
68PLMSP-8M-6G	8	3/8	20	30.50	7.50	22.00
68PLMSP-10M-4G	10	1/4	16	34.50	6.50	17.50
68PLMSP-10M-6G	10	3/8	20	35.50	7.50	22.00
68PLMSP-10M-8G	10	1/2	24	37.00	7.50	26.00
68PLMSP-12M-6G	12	3/8	20	36.50	7.50	22.00
68PLMSP-12M-8G	12	1/2	24	38.00	7.50	26.00
68PLMSP-14M-8G	14	1/2	24	40.00	8.00	26.00

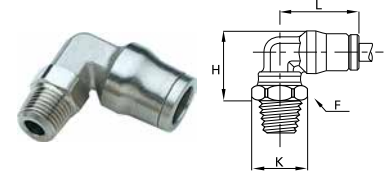

**169PLM Male Elbow Inch Tube to NPT, UNF**

PART NO.	TUBE SIZE IN	NPT/UNF	F MM	H IN	K IN	L IN
169PLM-4M-0	5/32(4MM)	10-32	10	0.71	0.43	.71
169PLM-4M-2	5/32(4MM)	1/8	11	.59	.47	.71
169PLM-4M-4	5/32(4MM)	1/4	14	.67	.60	.71
169PLM-4-2	1/4	1/8	11	.69	.47	.87
169PLM-4-4	1/4	1/4	14	.75	.60	.87
169PLM-4-6	1/4	3/8	18	.75	.77	.87
169PLM-6-4	3/8	1/4	15	.93	.63	1.14
169PLM-6-6	3/8	3/8	18	1.02	.77	1.14
169PLM-6-8	3/8	1/2	22	1.06	.94	1.14
169PLM-8-6	1/2	3/8	18	1.14	.77	1.22
169PLM-8-8	1/2	1/2	22	1.14	.94	1.22

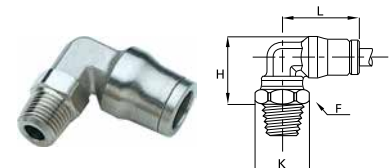

**169PLM Male Elbow Metric Tube to BSPT**

PART NO.	TUBE SIZE MM	BSPT	F MM	H MM	K MM	L MM
169PLM-4M-2R	4	1/8	11	15.00	12.00	18.00
169PLM-4M-4R	4	1/4	14	17.00	15.00	18.00
169PLM-6M-2R	6	1/8	11	17.50	12.00	21.50
169PLM-6M-4R	6	1/4	14	19.00	15.00	21.50
169PLM-8M-2R	8	1/8	11	19.50	12.00	23.50
169PLM-8M-4R	8	1/4	14	21.00	15.00	23.50
169PLM-8M-6R	8	3/8	17	21.00	18.50	23.50
169PLM-10M-4R	10	1/4	15	23.50	16.00	29.00
169PLM-10M-6R	10	3/8	17	25.50	18.50	29.00
169PLM-12M-4R	12	1/4	15	26.00	16.00	31.00
169PLM-12M-6R	12	3/8	17	28.50	18.50	31.00
169PLM-12M-8R	12	1/2	21	28.50	23.00	31.00
169PLM-14M-6R	14	3/8	19	29.00	21.00	34.00
169PLM-14M-8R	14	1/2	24	30.00	26.00	34.00

**WARNING** These products can expose you to chemicals including LEAD which is known to the state of California to cause cancer and birth defects or other reproductive harm. For more information go to [www.P65Warnings.ca.gov](http://www.P65Warnings.ca.gov).



- A
- B
- C
- D
- E
- F
- G
- H
- I
- J
- K
- L
- M
- N
- O

[Click here for CADs, Product Specifications or to Configure Parts Online](#)

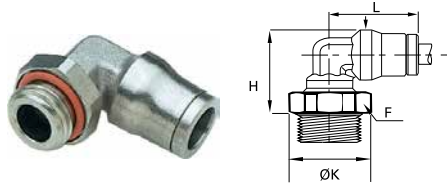

**169PLM Male Elbow Tube to BSPP, Metric**

PART NO.	TUBE SIZE MM	BSPP/METRIC	F MM	H MM	K MM	L MM
169PLM-4M-M5	4	M5X0.8	10	18.00	11.00	18.00
169PLM-4M-2G	4	1/8	13	17.00	14.00	18.00
169PLM-4M-M6	4	M6X1	10	18.00	11.00	18.00
169PLM-4M-4G	4	1/4	16	17.50	17.50	18.00
169PLM-4M-M8	4	M8X1	11	18.00	12.00	18.00
169PLM-6M-M5	6	M5X0.8	10	20	14	22
169PLM-6M-2G	6	1/8	13	19.00	14.00	21.50
169PLM-6M-M10	6	M10X1	13	19.00	14.00	21.50
169PLM-6M-4G	6	1/4	16	19.50	17.50	21.50
169PLM-8M-2G	8	1/8	13	20.50	14.00	23.50
169PLM-8M-4G	8	1/4	16	21.50	17.50	23.50
169PLM-8M-6G	8	3/8	20	21.50	22.00	23.50
169PLM-10M-4G	10	1/4	16	27.00	17.50	29.00
169PLM-10M-6G	10	3/8	20	25.50	22.00	29.00
169PLM-12M-4G	12	1/4	16	29.50	17.50	31.00
169PLM-12M-6G	12	3/8	20	28.50	22.00	31.00
169PLM-12M-8G	12	1/2	24	28.50	26.00	31.00
169PLM-14M-6G	14	3/8	20	29.00	22.00	34.00
169PLM-14M-8G	14	1/2	24	29.50	26.00	34.00



**169PLMX Extended Male Elbow Metric Tube to BSPP or M5**

PART NO.	TUBE SIZE MM	BSPP/M5	F MM	H MM	K MM	L MM
169PLMX-4M-M5	4	M5X0.8	10	27.50	11.00	18.00
169PLMX-4M-2G	4	1/8	13	25.50	14.00	18.00
169PLMX-6M-2G	6	1/8	13	31.00	14.00	18.00
169PLMX-6M-4G	6	1/4	16	30.50	17.50	21.50
169PLMX-8M-2G	8	1/8	14	33.50	15.00	23.50
169PLMX-8M-4G	8	1/4	16	34.00	17.50	23.50
169PLMX-10M-4G	10	1/4	18	42.00	19.50	29.00
169PLMX-10M-6G	10	3/8	20	41.00	22.00	29.00
169PLMX-12M-4G	12	1/4	20	47.00	22.00	31.00
169PLMX-12M-6G	12	3/8	20	46.00	22.00	31.00
169PLMX-14M-8G	14	1/2	24	49.00	26.00	34.00

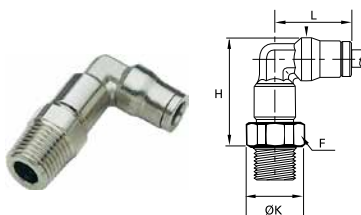

**169PLMX Extended Male Elbow Metric Tube to BSPT**

PART NO.	TUBE SIZE MM	BSPT	F MM	H MM	K MM	L MM
169PLMX-4M-2R	4	1/8	10	24.50	11.00	18.00
169PLMX-6M-2R	6	1/8	13	29.50	14.00	21.50
169PLMX-6M-4R	6	1/4	14	30.50	15.00	21.50
169PLMX-8M-2R	8	1/8	14	32.50	15.00	23.50
169PLMX-8M-4R	8	1/4	14	34.00	15.00	23.50
169PLMX-10M-4R	10	1/4	18	39.00	19.50	29.00

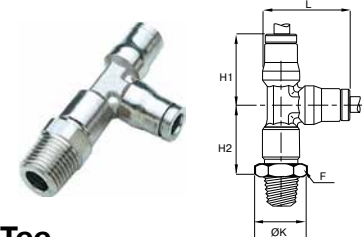

**171PLM Male Run Tee Inch Tube to Tube to NPT, UNF**

PART NO.	TUBE SIZE IN	NPT/UNF	F MM	H1 IN	H2 IN	K IN	L IN
171PLM-4M-2	5/32(4MM)	1/8	11	.71	.77	.47	.91
171PLM-6-4	3/8	1/4	18	1.14	1.20	.77	1.48
171PLM-6-6	3/8	3/8	18	1.14	1.28	.77	1.48
171PLM-6-8	3/8	1/2	22	1.14	1.28	.94	1.48
171PLM-8-6	1/2	3/8	22	1.22	1.46	.94	1.61

**WARNING** These products can expose you to chemicals including LEAD which is known to the state of California to cause cancer and birth defects or other reproductive harm. For more information go to [www.P65Warnings.ca.gov](http://www.P65Warnings.ca.gov).





[Click here for CADs, Product Specifications or to Configure Parts Online](#)

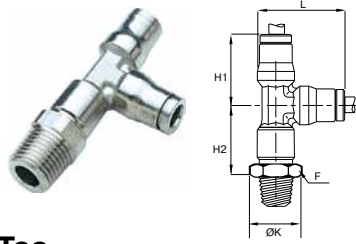

**171PLM Male Run Tee  
Metric Tube to Tube to BSPT**

PART NO.	TUBE SIZE MM	BSPT	F MM	H1 MM	H2 MM	K MM	L MM
171PLM-4M-2R	4	1/8	10	18.00	19.50	11.00	23.00
171PLM-6M-2R	6	1/8	13	21.50	23.50	14.00	28.00
171PLM-6M-4R	6	1/4	14	21.50	24.50	15.00	28.00
171PLM-8M-2R	8	1/8	14	23.50	25.00	15.00	31.00
171PLM-8M-4R	8	1/4	14	23.50	26.50	15.00	31.00
171PLM-10M-4R	10	1/4	18	29.00	30.50	19.50	37.50
171PLM-10M-6R	10	3/8	18	29.00	32.50	19.50	37.50
171PLM-12M-6R	12	3/8	21	31.00	36.50	23.00	40.50
171PLM-14M-8R	14	1/2	22	34.00	40.00	24.00	45.00

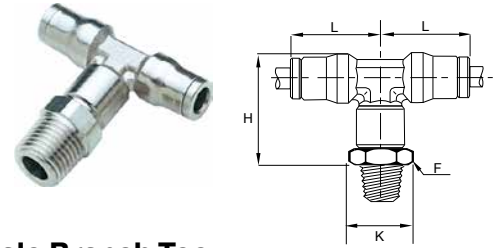

**172PLM Male Branch Tee  
Inch Tube to NPT to Tube**

PART NO.	TUBE SIZE IN	NPT/UNF	F MM	H IN	K IN	L IN
172PLM-4M-0	5/32(4MM)	10-32	10.00	1.00	.47	.71

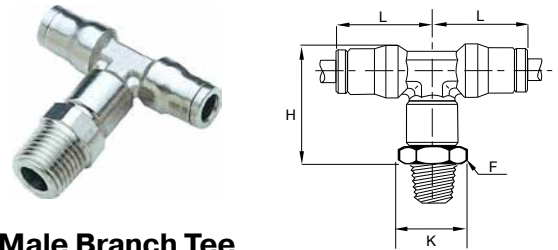

**172PLM Male Branch Tee  
Metric Tube to BSPT**

PART NO.	TUBE SIZE MM	BSPT	F MM	H MM	K MM	L MM
172PLM-4M-2R	4	1/8	10	24.50	11.00	18.00
172PLM-6M-2R	6	1/8	13	29.50	14.00	21.50
172PLM-6M-4R	6	1/4	14	30.50	15.00	21.50
172PLM-8M-2R	8	1/8	14	32.50	15.00	23.50
172PLM-8M-4R	8	1/4	14	34.00	15.00	23.50
172PLM-10M-4R	10	1/4	18	39.00	19.50	29.00
172PLM-10M-6R	10	3/8	18	41.00	19.50	29.00
172PLM-12M-6R	12	3/8	21	46.50	23.00	31.00
172PLM-14M-8R	14	1/2	22	50.50	24.00	34.00

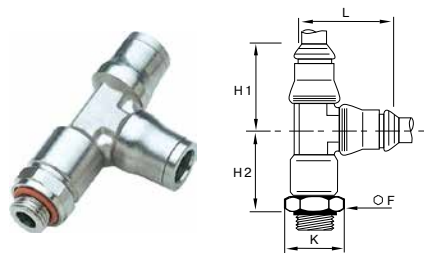

**171PLM Male Run Tee  
Tube to Tube to BSPP or M5**

PART NO.	TUBE SIZE MM	BSPP/M5	F MM	H1 MM	H2 MM	K MM	L MM
171PLM-4M-M5	4	M5X0.8	10	18.00	22.50	11.00	23.00
171PLM-6M-2G	6	1/8	13	21.50	25.00	14.00	28.00
171PLM-6M-4G	6	1/4	16	21.50	24.50	17.50	28.00
171PLM-8M-2G	8	1/8	14	23.50	26.50	15.00	31.00
171PLM-8M-4G	8	1/4	16	23.50	26.50	17.50	31.00
171PLM-10M-4G	10	1/4	18	29.00	33.00	19.50	37.50
171PLM-12M-6G	12	3/8	21	31.00	36.50	23.00	40.50
171PLM-14M-8G	14	1/2	24	34.00	38.50	26.00	45.00

**WARNING** These products can expose you to chemicals including LEAD which is known to the state of California to cause cancer and birth defects or other reproductive harm. For more information go to [www.P65Warnings.ca.gov](http://www.P65Warnings.ca.gov).



- A
- B
- C
- D
- E
- F
- G
- H
- I
- J
- K
- L
- M
- N
- O

[Click here for CADs, Product Specifications or to Configure Parts Online](#)

- A
- B
- C
- D
- E
- F
- G
- H
- I
- J
- K
- L
- M
- N
- O

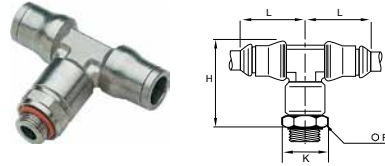

### 172PLM Male Branch Tee Tube to BSPP or M5

PART NO.	TUBE SIZE MM	BSPP/M5	F MM	H MM	K MM	L MM
172PLM-4M-M5	4	M5X0.8	10	27.50	11.00	18.00
172PLM-4M-2G	4	1/8	13	25.50	14.00	18.00
172PLM-6M-2G	6	1/8	13	31.00	14.00	21.50
172PLM-6M-4G	6	1/4	16	30.50	17.50	21.50
172PLM-8M-2G	8	1/8	14	33.50	15.00	23.50
172PLM-8M-4G	8	1/4	16	34.00	17.50	23.50
172PLM-10M-4G	10	1/4	18	42.00	19.50	29.00
172PLM-12M-6G	12	3/8	21	46.00	23.00	31.00
172PLM-14M-8G	14	1/2	24	49.00	26.00	34.00

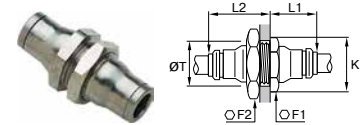

### 62PLMBH Bulkhead Connector Inch Tube to Tube

PART NO.	TUBE SIZE IN	F1 MM	F2 MM	K IN	L1 IN	L2 IN	T IN
62PLMBH-4	1/4	16	17	.69	.67	.89	.59
62PLMBH-6	3/8	22	27	.95	.87	1.10	.85
62PLMBH-8	1/2	24	24	1.16	.89	1.14	1.04

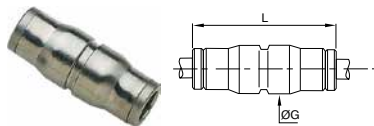

### 62PLM Straight Union Inch Tube to Tube

PART NO.	TUBE SIZE IN	G IN	L IN
62PLM-4	1/4	.49	1.44
62PLM-6	3/8	.67	1.87
62PLM-8	1/2	.79	1.89

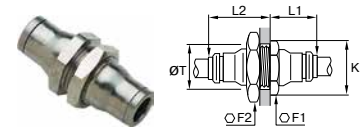

### 62PLMBH Bulkhead Connector Metric Tube to Tube

PART NO.	TUBE SIZE MM	F1 MM	F2 MM	K MM	L1 MM	L2 MM	T MM
62PLMBH-4M	4MM(5/32)	13	14	14.00	14.00	20.00	12.50
62PLMBH-6M	6	16	17	17.50	17.00	22.00	15.00
62PLMBH-8M	8MM(5/16)	18	19	19.50	18.50	23.50	17.00
62PLMBH-10M	10	22	27	24.00	21.50	26.50	21.00
62PLMBH-12M	12	24	24	26.00	23.00	27.00	23.00
62PLMBH-14M	14	27	27	29.50	25.50	29.50	25.00

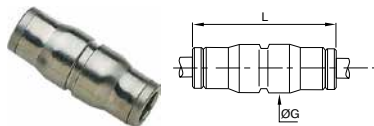

### 62PLM Straight Union Metric Tube to Tube

PART NO.	TUBE SIZE MM	G MM	L MM
62PLM-4M	4MM(5/32)	10.00	30.50
62PLM-6M	6	12.00	36.50
62PLM-8M	8MM(5/16)	15.00	37.50
62PLM-10M	10	17.50	47.50
62PLM-12M	12	19.50	50.00
62PLM-14M	14	21.50	52.50

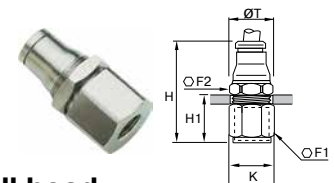

### 66PLMBH Female Bulkhead Connector Metric Tube to BSPP

PART NO.	TUBE SIZE MM	BSPP	F1 MM	F2 MM	H MM	H1 MM	K MM	T MM
66PLMBH-4M-2G	4	1/8	14	14	30.50	11.00	15.00	13
66PLMBH-6M-2G	6	1/8	17	17	32.50	11.00	18.50	15
66PLMBH-6M-4G	6	1/4	17	17	37.00	15.00	18.50	15
66PLMBH-8M-2G	8	1/8	19	19	34.00	10.50	21.00	17
66PLMBH-8M-4G	8	1/4	19	19	38.00	14.50	21.00	17
66PLMBH-10M-6G	10	3/8	22	27	42.50	16.00	24.00	21
66PLMBH-12M-6G	12	3/8	24	24	43.00	16.00	26.00	23
66PLMBH-12M-8G	12	1/2	27	24	48.50	21.50	29.50	23

**WARNING** These products can expose you to chemicals including LEAD which is known to the state of California to cause cancer and birth defects or other reproductive harm. For more information go to [www.P65Warnings.ca.gov](http://www.P65Warnings.ca.gov).



[Click here for CADs, Product Specifications or to Configure Parts Online](#)

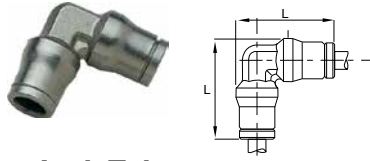

**165PLM Union Elbow Inch Tube**

PART NO.	TUBE SIZE IN	L IN
165PLM-4	1/4	1.12
165PLM-6	3/8	1.48
165PLM-8	1/2	1.61

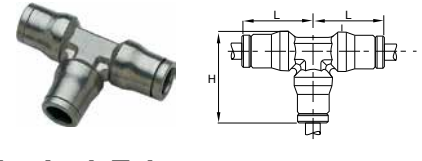

**164PLM Union Tee Inch Tube**

PART NO.	TUBE SIZE IN	H IN	L IN
164PLM-4	1/4	1.12	.87
164PLM-6	3/8	1.48	1.14
164PLM-8	1/2	1.61	1.22

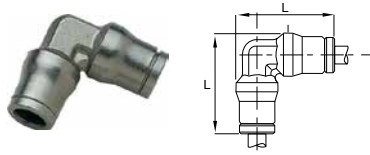

**165PLM Union Elbow Metric Tube**

PART NO.	TUBE SIZE MM	L MM
165PLM-4M	4MM(5/32)	23.00
165PLM-6M	6	28.00
165PLM-8M	8MM(5/16)	31.00
165PLM-10M	10	37.50
165PLM-12M	12	40.50
165PLM-14M	14	45.00

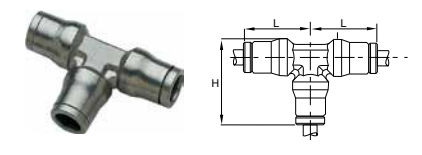

**164PLM Union Tee Metric Tube**

PART NO.	TUBE SIZE MM	H MM	L MM
164PLM-4M	4MM(5/32)	23.00	18.00
164PLM-6M	6	28.00	21.50
164PLM-8M	8MM(5/16)	31.00	23.50
164PLM-10M	10	37.50	29.00
164PLM-12M	12	40.50	31.00
164PLM-14M	14	45.00	34.00



**165PLMBH Bulkhead Elbow Metric Tube**

PART NO.	TUBE SIZE MM	F1 MM	F2 MM	H MM	L MM	T MM
165PLMBH-4M	4	13	14	35.00	18.00	12.50
165PLMBH-6M	6	16	17	40.50	21.50	15.00
165PLMBH-8M	8	18	19	44.00	23.50	17.00
165PLMBH-10M	10	22	27	51.00	29.00	21.00
165PLMBH-12M	12	24	24	55.00	31.00	23.00
165PLMBH-14M	14	27	27	59.00	34.00	25.00

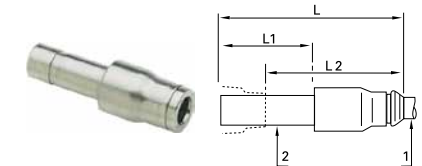

**67PLM Plug-In Reducer Metric**

PART NO.	TUBE 1 SIZE MM	TUBE 2 SIZE MM	L MM	L1 MM	L2 MM
67PLM-4M-6M	4	6	34.50	19.00	17.50
67PLM-4M-8M	4	8	35.50	20.00	18.00
67PLM-6M-8M	6	8	37.00	20.00	19.50
67PLM-6M-10M	6	10	43.50	25.00	21.00
67PLM-8M-10M	8	10	44.00	25.00	21.50
67PLM-8M-12M	8	12	45.00	26.00	21.50
67PLM-10M-12M	10	12	50.00	26.00	26.50
67PLM-12M-14M	12	14	53.00	28.00	28.50

**WARNING** These products can expose you to chemicals including LEAD which is known to the state of California to cause cancer and birth defects or other reproductive harm. For more information go to [www.P65Warnings.ca.gov](http://www.P65Warnings.ca.gov).



Click here for CADs, Product Specifications or to Configure Parts Online

- A
- B
- C
- D
- E
- F
- G
- H
- I
- J
- K
- L
- M
- N
- O

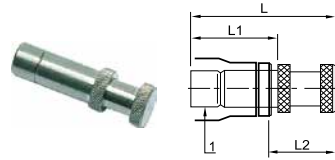

### 639PLM Plug Metric

PART NO.	TUBE 1 SIZE MM	L MM	L1 MM	L2 MM
639PLM-4M	4	25.50	17.00	11.50
639PLM-6M	6	30.50	19.50	13.50
639PLM-8M	8	33.00	20.00	16.00
639PLM-10M	10	40.00	25.00	18.00
639PLM-12M	12	43.00	26.00	20.00
639PLM-14M	14	47.00	28.00	22.50

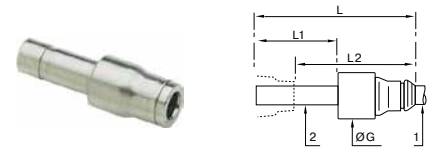

### 62PLMSP Plug-In Expander Metric

PART NO.	TUBE 1 SIZE MM	TUBE 2 SIZE MM	G MM	L MM	L1 MM	L2 MM
62PLMSP-4-6	6	4	17	42	22	28

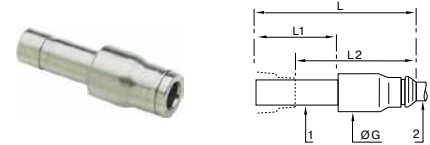

### 62PLMSP Plug-In Metric/Inch Adapter

PART NO.	TUBE 1 SIZE MM	TUBE 2 SIZE IN	G MM	L MM	L1 MM	L2 MM
62PLMSP-4-6M	6	1/4	12.50	38.00	19.00	20.50
62PLMSP-6-10M	10	3/8	17.00	49.50	25.00	27.00
62PLMSP-8-12M	12	1/2	20.00	51.00	26.00	27.50

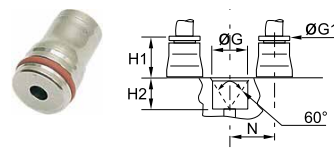

### PLMC Cartridge

PART NO.	TUBE SIZE MM	G +.1 - 0	H1 MM	H2 MM	N MM
PLMC-4M	4	10.00	9.00	8.50	11.00
PLMC-6M	6	12.00	11.00	8.50	13.50
PLMC-8M	8	15.00	12.50	8.50	16.00
PLMC-10M	10	17.50	14.50	10.50	20.00
PLMC-12M	12	19.50	15.00	10.50	22.50
PLMC-14M	14	21.50	16.50	12.00	25.00

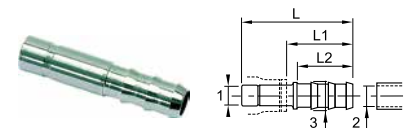

### 122PLMSP Plug-In Barbed Connector Metric

PART NO.	TUBE 1 SIZE MM	TUBE 2 SIZE MM	TUBE 3 SIZE MM	L MM	L1 MM	L2 MM
122PLMSP-4M-3M	4	3.20	5.00	40.50	27.00	22.50
122PLMSP-4M-5M	4	5.00	7.00	40.50	27.00	22.50
122PLMSP-6M-5M	6	5.00	7.00	43.00	27.00	22.50
122PLMSP-8M-6M	8	6.30	8.30	42.00	25.00	22.50
122PLMSP-8M-8M	8	8.00	10.00	44.00	27.00	22.50
122PLMSP-10M-6M	10	6.30	8.30	47.50	25.50	22.50
122PLMSP-10M-8M	10	8.00	10.00	47.50	25.50	22.50
122PLMSP-12M-8M	12	8.00	10.00	48.50	25.50	22.50
122PLMSP-12M10M	12	10.00	12.00	48.50	25.50	22.50
122PLMSP-12M12M	12	12.50	14.50	57.00	34.00	29.50
122PLMSP-14M12M	14	12.50	14.50	57.50	33.00	29.50
122PLMSP-14M14M	14	14.00	16.00	59.50	35.00	29.50

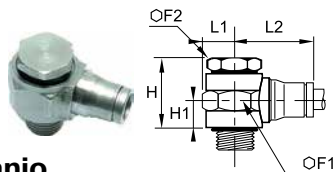

### 169PLMBJ Single Banjo Metric Tube to BSPP or M5

PART NO.	TUBE SIZE MM	BSPP/M5	F1 MM	F2 MM	H MM	H1 MM	L1 MM	L2 MM
169PLMBJ-4M-M5	4	M5X0.8	10	8	14.50	6.50	6.00	18.50
169PLMBJ-4M-2G	4	G1/8	17	14	23.00	9.50	10.00	20.50
169PLMBJ-6M-M5	6	M5X0.8	10	8	15.00	7.00	6.00	22.50
169PLMBJ-6M-2G	6	G1/8	17	14	23.00	9.50	10.00	23.50
169PLMBJ-6M-4G	6	G1/4	22	17	22.00	9.00	13.00	25.50
169PLMBJ-8M-2G	8	G1/8	17	14	23.00	9.50	10.00	26.00
169PLMBJ-8M-4G	8	G1/4	22	17	22.00	9.00	13.00	27.50
169PLMBJ-10M-6G	10	G3/8	22	22	33.00	14.00	13.00	32.00

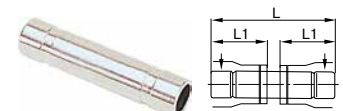

### 63PLM Double Male Union Metric

PART NO.	TUBE SIZE MM	L MM	L1 MM
63PLM-4M	4	31.00	14.00
63PLM-6M	6	36.50	17.00
63PLM-8M	8	37.50	17.50
63PLM-10M	10	47.50	22.50
63PLM-12M	12	49.50	23.50
63PLM-14M	14	53.00	25.00

**WARNING** These products can expose you to chemicals including LEAD which is known to the state of California to cause cancer and birth defects or other reproductive harm. For more information go to [www.P65Warnings.ca.gov](http://www.P65Warnings.ca.gov).





# Prestolok PLS Stainless Steel Push-to-Connect Fittings

Parker's Prestolok PLS fittings are ideal for conveying corrosive fluids in aggressive environments. Prestolok PLS fittings provide corrosion resistance and a hygienic external design.

## Product Features:

- Stainless steel 316L collet
- Stainless steel 316L body
- FKM seal
- Stainless steel 316L backup washer
- Chemical, corrosion, and abrasion resistance
- Hygienic design reduces retention zones for easy cleaning
- NPT, BSPT, BSPP, and metric threads
- Silicone Free

## Markets:

- Petrochemical
- Life Science
- Pulp and Paper
- Food Processing
- Wash Down

## Compatible Media:

- Food Fluids
- Chemicals
- Cleaning Agents
- Compressed Air
- Inert Gases

## Specifications:

<b>Pressure Range</b>	Up to 435 psi (30 bar) 290 psi (19.9 bar) for 169PLS
<b>Temperature Range</b>	-13° to +302° F (-25° to +150° C)
<b>Vacuum Rating</b>	28" Hg

Note: Maximum pressure and temperature range depend on the type of tubing used.

## Compatible Tubing:

- Semi-rigid nylon
- Polyethylene
- Polyurethane 95 Durometer Shore A
- Stainless Steel (grooved)
- Copper (grooved)
- FEP

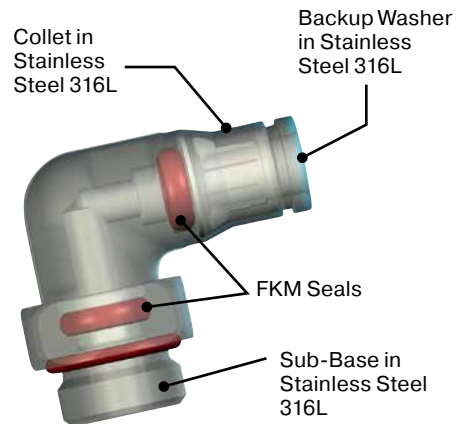

## Assembly Instructions

1. Cut tubing squarely – maximum of 15° angle allowable.
2. Check that port or mating part is clean and free of debris.
3. Mark tubing to appropriate tube insertion length. (see Tube Insertion Chart on page N22)
4. Insert tubing until it bottoms
5. Pull on tubing to verify it is fully inserted
6. To disassemble, simply press release button, hold against body and pull tubing out of fitting.

**WARNING** These products can expose you to chemicals including NICKEL, which is known to the state of California to cause cancer. For more information go to [www.P65Warnings.ca.gov](http://www.P65Warnings.ca.gov).



- A
- B
- C
- D
- E
- F
- G
- H
- I
- J
- K
- L
- M
- N
- O

**Threaded Fittings**

**68PLS**

Male Connector  
NPT, BSPT  
p. A55



**68PLS**

Male Connector  
BSPP  
p. A55



**169PLS**

Male Elbow  
NPT, BSPT  
p. A57



**169PLS**

Male Elbow  
BSPP  
p. A57



**169PLSX**

Extended Male  
Elbow – NPT, BSPT  
p. A58



**169PLSX**

Extended Male  
Elbow – BSPP  
p. A58



**Tube to Tube Fittings**

**62PLS**

Union  
p. A58



**165PLS**

Union Elbow  
p. A59



**164PLS**

Union Tee  
p. A59



**Bulkhead Union**

**62PLSBH**

Bulkhead Union  
p. A59



**Standpipes**

**68PLSSP**

Male Standpipe  
NPT, BSPT  
p. A56



**68PLSSP**

Male Standpipe  
BSPP  
p. A56



**Plug-In Fittings & Accessories**

**67PLS**

Tube Reducer  
p. A60



**639PLS**

Plug  
p. A60



**PLSC**

Cartridge  
p. A60



**WARNING** These products can expose you to chemicals including NICKEL, which is known to the state of California to cause cancer. For more information go to [www.P65Warnings.ca.gov](http://www.P65Warnings.ca.gov).



[Click here for CADs, Product Specifications or to Configure Parts Online](#)

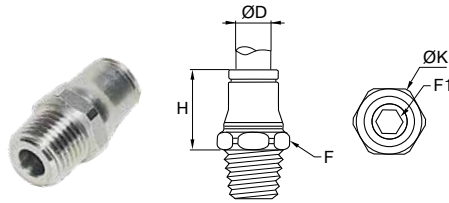

**68PLS Male Connector - Inch Tube to NPT, UNF**

PART NO.	TUBE SIZE IN	NPT / UNF	F MM	F1 MM	H IN	K IN
68PLS-4M-0	5/32(4MM)	10-32	10	2.5	.59	.43
68PLS-3-2	3/16	1/8	10	3	.61	.43
68PLS-4-2	1/4	1/8	13	4	.75	.55
68PLS-4-4	1/4	1/4	14	4	.69	.59
68PLS-6-4	3/8	1/4	19	6	.98	.83
68PLS-6-6	3/8	3/8	19	7	.94	.83
68PLS-8-4	1/2	1/4	22	7	1.02	.94
68PLS-8-6	1/2	3/8	22	8	.98	.94
68PLS-8-8	1/2	1/2	22	10	.98	.94

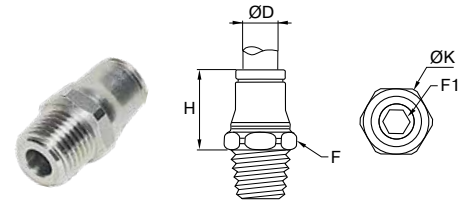

**68PLS Male Connector - Metric Tube to BSPT**

PART NO.	TUBE SIZE MM	BSPT	F MM	F1 MM	H MM	K MM
68PLS-4M-2R	4	1/8	10	3	14.50	11.00
68PLS-4M-4R	4	1/4	14	3	14.50	15.00
68PLS-6M-2R	6	1/8	13	4	18.00	14.00
68PLS-6M-4R	6	1/4	14	4	16.50	15.00
68PLS-8M-2R	8	1/8	15	5	20.50	16.50
68PLS-8M-4R	8	1/4	15	5	19.00	16.50
68PLS-8M-6R	8	3/8	17	6	19.00	18.50
68PLS-10M-4R	10	1/4	19	6	24.00	21.00
68PLS-10M-6R	10	3/8	19	7	22.50	21.00
68PLS-12M-4R	12	1/4	22	7	25.00	24.00
68PLS-12M-6R	12	3/8	22	8	24.00	24.00
68PLS-12M-8R	12	1/2	22	10	23.00	24.00

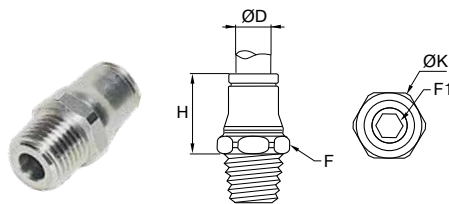

**68PLS Male Connector - Metric Tube to NPT**

PART NO.	TUBE SIZE MM	NPT	F MM	F1 MM	H MM	K MM
68PLS-4M-2	4MM(5/32)	1/8	11	3	14.50	12.00
68PLS-6M-2	6	1/8	13	4	18.00	14.00
68PLS-6M-4	6	1/4	14	4	16.50	15.00
68PLS-8M-2	8MM(5/16)	1/8	15	5	19.00	16.50
68PLS-8M-4	8MM(5/16)	1/4	15	6	18.00	16.50
68PLS-10M-4	10	1/4	19	6	24.00	21.00
68PLS-10M-6	10	3/8	19	7	22.50	21.00
68PLS-12M-4	12	1/4	22	7	25.00	24.00
68PLS-12M-6	12	3/8	22	8	24.00	24.00
68PLS-12M-8	12	1/2	22	10	23.00	24.00

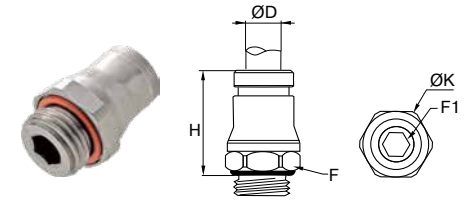

**68PLS Male Connector - Metric Tube to BSPP, M5**

PART NO.	TUBE SIZE MM	BSPP / M5	F MM	F1 MM	H MM	K MM
68PLS-4M-M5	4	M5X0.8	10	2.5	16.00	11.00
68PLS-4M-2G	4	1/8	13	3	15.00	14.00
68PLS-6M-M5	6	M5X0.8	13	2.5	20.50	14.00
68PLS-6M-2G	6	1/8	13	4	18.00	14.00
68PLS-6M-4G	6	1/4	17	4	18.00	18.50
68PLS-8M-2G	8	1/8	15	5	19.00	16.50
68PLS-8M-4G	8	1/4	17	5	20.50	18.50
68PLS-8M-6G	8	3/8	21	6	20.00	23.00
68PLS-10M-4G	10	1/4	18	7	25.00	19.50
68PLS-10M-6G	10	3/8	21	7	25.00	23.00
68PLS-12M-4G	12	1/4	21	7	27.00	23.00
68PLS-12M-6G	12	3/8	21	9	26.50	23.00

**WARNING** These products can expose you to chemicals including NICKEL, which is known to the state of California to cause cancer. For more information go to [www.P65Warnings.ca.gov](http://www.P65Warnings.ca.gov).



Click here for CADs, Product Specifications or to Configure Parts Online

- A
- B
- C
- D
- E
- F
- G
- H
- I
- J
- K
- L
- M
- N
- O

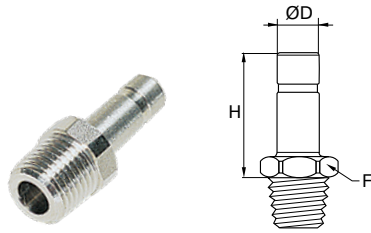

**68PLSSP Male Standpipe - Inch Tube to NPT**

PART NO.	TUBE SIZE IN	NPT	F IN	H IN
68PLSSP-4-2	1/4	1/8	0.39	1.02
68PLSSP-4-4	1/4	1/4	0.55	1.06
68PLSSP-6-4	3/8	1/4	0.75	1.26
68PLSSP-6-6	3/8	3/8	0.75	1.26
68PLSSP-8-4	1/2	1/4	0.75	1.42
68PLSSP-8-6	1/2	3/8	0.75	1.46
68PLSSP-8-8	1/2	1/2	0.87	1.46

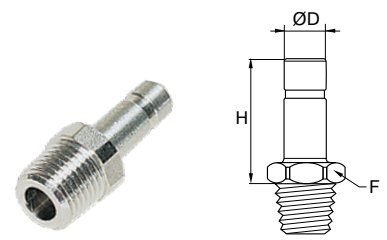

**68PLSSP Male Standpipe - Metric Tube to BSPT**

PART NO.	TUBE SIZE MM	BSPT	F MM	H MM
68PLSSP-4M-2R	4	1/8	10	21
68PLSSP-6M-2R	6	1/8	10	23
68PLSSP-6M-4R	6	1/4	14	24
68PLSSP-8M-2R	8	1/8	10	24
68PLSSP-8M-4R	8	1/4	14	25
68PLSSP-10M-4R	10	1/4	14	30
68PLSSP-10M-6R	10	3/8	17	30
68PLSSP-12M-4R	12	1/4	14	31
68PLSSP-12M-6R	12	3/8	17	31
68PLSSP-12M-8R	12	1/2	22	32

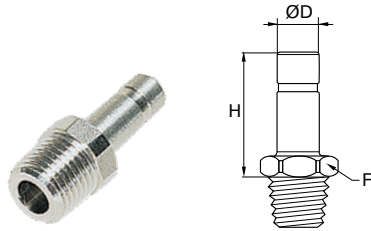

**68PLSSP Male Standpipe - Metric Tube to NPT**

PART NO.	TUBE SIZE MM	NPT	F MM	H MM
68PLSSP-4M-2	4MM(5/32)	1/8	11	21
68PLSSP-6M-2	6	1/8	11	23
68PLSSP-6M-4	6	1/4	14	24
68PLSSP-8M-2	8MM(5/16)	1/8	14	24
68PLSSP-8M-4	8MM(5/16)	1/4	14	25
68PLSSP-10M-4	10	1/4	14	30
68PLSSP-10M-6	10	3/8	17	30

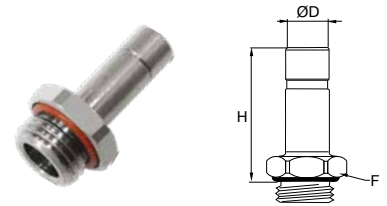

**68PLSSP Male Standpipe - Metric Tube to BSPP, M5**

PART NO.	TUBE SIZE MM	BSPP / M5	F MM	H MM
68PLSSP-4M-M5	4	M5X0.8	7	23.50
68PLSSP-4M-2G	4	1/8	13	22.00
68PLSSP-6M-2G	6	1/8	13	24.00
68PLSSP-6M-4G	6	1/4	17	24.00
68PLSSP-8M-2G	8	1/8	13	25.00
68PLSSP-8M-4G	8	1/4	17	27.00
68PLSSP-8M-6G	8	3/8	21	27.00
68PLSSP-10M-4G	10	1/4	17	32.00
68PLSSP-10M-6G	10	3/8	21	27.00
68PLSSP-12M-4G	12	1/4	17	33.00
68PLSSP-12M-6G	12	3/8	21	33.00

**WARNING** These products can expose you to chemicals including NICKEL, which is known to the state of California to cause cancer. For more information go to [www.P65Warnings.ca.gov](http://www.P65Warnings.ca.gov).





[Click here for CADs, Product Specifications or to Configure Parts Online](#)

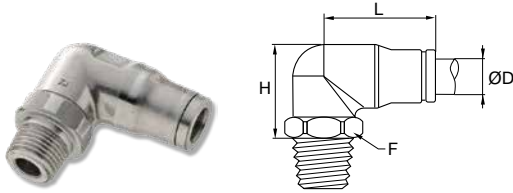

**169PLS Male Elbow - Inch Tube to NPT, UNF**

PART NO.	TUBE SIZE IN	NPT / UNF	F MM	H IN	L IN
169PLS-4M-0	5/32(4MM)	10-32	10	.98	.77
169PLS-4-2	1/4	1/8	13	.85	.91
169PLS-4-4	1/4	1/4	14	.85	.91
169PLS-6-4	3/8	1/4	17	1.12	1.20
169PLS-6-6	3/8	3/8	19	1.12	1.20
169PLS-8-4	1/2	1/4	22	1.34	1.30
169PLS-8-6	1/2	3/8	22	1.34	1.30
169PLS-8-8	1/2	1/2	22	1.34	1.30

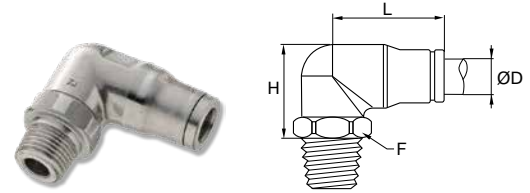

**169PLS Male Elbow - Metric Tube to BSPT**

PART NO.	TUBE SIZE MM	BSPT	F MM	H MM	L MM
169PLS-4M-2R	4	1/8	13	18.00	19.00
169PLS-4M-4R	4	1/4	14	18.00	19.00
169PLS-6M-2R	6	1/8	13	20.00	24.00
169PLS-6M-4R	6	1/4	14	20.00	23.00
169PLS-8M-2R	8	1/8	13	24.50	32.00
169PLS-8M-4R	8	1/4	14	23.50	24.00
169PLS-8M-6R	8	3/8	19	23.00	25.00
169PLS-10M-4R	10	1/4	17	27.00	31.00
169PLS-10M-6R	10	3/8	19	26.00	31.00
169PLS-12M-4R	12	1/4	22	31.50	33.00
169PLS-12M-6R	12	3/8	22	32.50	33.00
169PLS-12M-8R	12	1/2	22	27.50	33.00

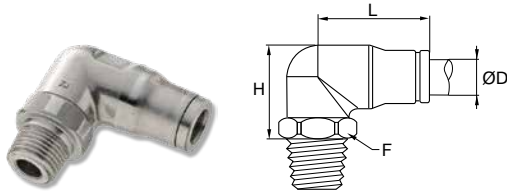

**169PLS Male Elbow - Metric Tube to NPT**

PART NO.	TUBE SIZE MM	NPT	F MM	H MM	L MM
169PLS-6M-2	6	1/8	13	20.00	22.50
169PLS-6M-4	6	1/4	14	20.00	22.50
169PLS-8M-2	8MM(5/16)	1/8	13	25.00	24.00
169PLS-8M-4	8MM(5/16)	1/4	14	24.00	24.00
169PLS-10M-4	10	1/4	17	27.50	27.50
169PLS-10M-6	10	3/8	19	28.50	26.50
169PLS-12M-4	12	1/4	22	31.50	32.50
169PLS-12M-6	12	3/8	22	32.50	32.50
169PLS-12M-8	12	1/2	22	27.50	32.50

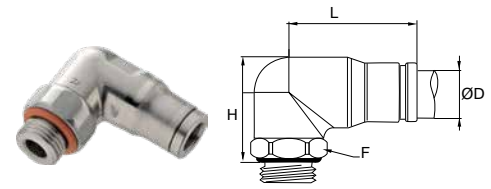

**169PLS Male Elbow - Metric Tube to BSPP**

PART NO.	TUBE SIZE MM	BSPP	F MM	H MM	L MM
169PLS-4M-2G	4	1/8	10	22	19
169PLS-4M-4G	4	1/4	17	20	19
169PLS-6M-2G	6	1/8	13	24	24
169PLS-6M-4G	6	1/4	17	22	24
169PLS-8M-2G	8	1/8	13	25	25
169PLS-8M-4G	8	1/4	17	25	25
169PLS-8M-6G	8	3/8	21	23	25
169PLS-10M-4G	10	1/4	18	29	31
169PLS-10M-6G	10	3/8	21	27	31
169PLS-12M-4G	12	1/4	17	33	33
169PLS-12M-6G	12	3/8	21	33	33
169PLS-12M-8G	12	1/2	24	30	33

**WARNING** These products can expose you to chemicals including NICKEL, which is known to the state of California to cause cancer. For more information go to [www.P65Warnings.ca.gov](http://www.P65Warnings.ca.gov).



- A
- B
- C
- D
- E
- F
- G
- H
- I
- J
- K
- L
- M
- N
- O

[Click here for CADs, Product Specifications or to Configure Parts Online](#)

A

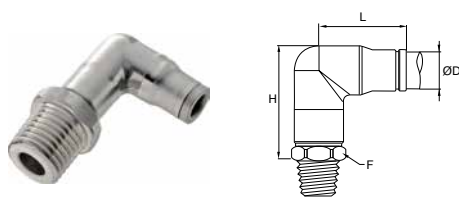

**169PLSX Extended Male Elbow - Metric Tube to NPT**

PART NO.	TUBE SIZE MM	NPT	F MM	H MM	L MM
169PLSX-6M-2	6	1/8	13	29	22.5
169PLSX-6M-4	6	1/4	14	29	22.5
169PLSX-8M-2	8	1/8	14	34	24
169PLSX-8M-4	8	1/4	14	34	24
169PLSX-10M-4	10	1/4	19	39.5	30
169PLSX-10M-6	10	3/8	19	39.5	30

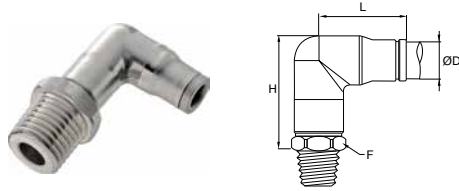

**169PLSX Extended Male Elbow - Metric Tube to BSPT**

PART NO.	TUBE SIZE MM	BSPT	F MM	H MM	L MM
169PLSX-4M-2R	4	1/8	10	25	19.00
169PLSX-6M-2R	6	1/8	13	30	24.00
169PLSX-6M-4R	6	1/4	14	30	24.00
169PLSX-8M-2R	8	1/8	14	34	24.90
169PLSX-8M-4R	8	1/4	14	34	24.90
169PLSX-10M-4R	10	1/4	19	39	31.00
169PLSX-10M-6R	10	3/8	19	39	31.00

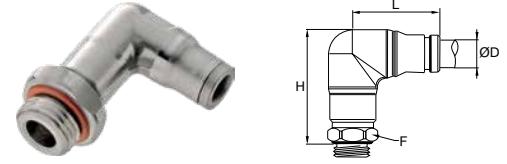

**169PLSX Extended Male Elbow - Metric Tube to BSPP, M5**

PART NO.	TUBE SIZE MM	BSPP / M5	F MM	H MM	L MM
169PLSX-4M-M5	4	M5X0.8	10	27.00	19
169PLSX-4M-2G	4	1/8	13	27.00	19
169PLSX-4M-4G	4	1/4	17	27.00	19
169PLSX-6M-M5	6	M5X0.8	13	33.00	24
169PLSX-6M-2G	6	1/8	13	33.00	24
169PLSX-6M-4G	6	1/4	17	32.00	24
169PLSX-8M-2G	8	1/8	14	35.00	25
169PLSX-8M-4G	8	1/4	17	35.00	25
169PLSX-8M-6G	8	3/8	21	34.50	25
169PLSX-10M-4G	10	1/4	18	43.00	31
169PLSX-10M-6G	10	3/8	21	42.00	31

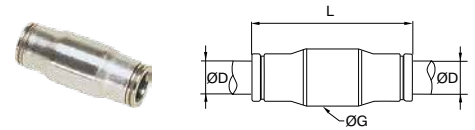

**62PLS Union - Inch Tube**

PART NO.	TUBE SIZE IN	G IN	H IN
62PLS-3	3/16	.39	1.18
62PLS-4	1/4	.47	1.38
62PLS-6	3/8	.69	1.81
62PLS-8	1/2	.79	1.89

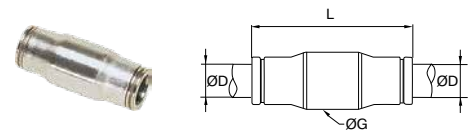

**62PLS Union - Metric Tube**

PART NO.	TUBE SIZE MM	G MM	H MM
62PLS-4M	4MM(5/32)	10.00	30.00
62PLS-6M	6	12.00	37.00
62PLS-8M	8MM(5/16)	15.00	38.00
62PLS-10M	10	17.00	49.00
62PLS-12M	12	19.50	49.50

**WARNING** These products can expose you to chemicals including NICKEL, which is known to the state of California to cause cancer. For more information go to [www.P65Warnings.ca.gov](http://www.P65Warnings.ca.gov).



B

C

D

E

F

G

H

I

J

K

L

M

N

O

[Click here for CADs, Product Specifications or to Configure Parts Online](#)

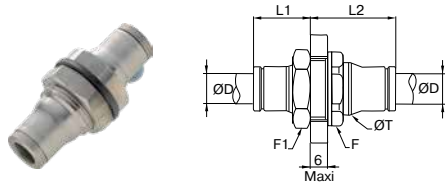

**62PLSBH Bulkhead Union - Inch Tube**

PART NO.	TUBE SIZE IN	F MM	F1 MM	L1 IN	L2 IN	T IN
62PLSBH-3	3/16	17	13	.59	.83	.49
62PLSBH-4	1/4	19	17	.67	.89	.59
62PLSBH-6	3/8	27	22	.87	1.08	.82
62PLSBH-8	1/2	27	27	.94	1.14	.98

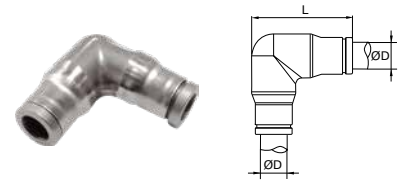

**165PLS Union Elbow - Metric Tube**

PART NO.	TUBE SIZE MM	L MM
165PLS-4M	4MM(5/32)	24.00
165PLS-6M	6	30.00
165PLS-8M	8MM(5/16)	32.20
165PLS-10M	10	39.00
165PLS-12M	12	43.00

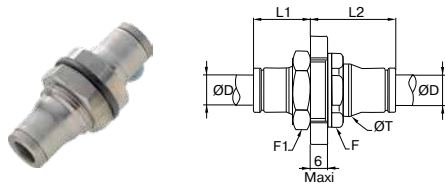

**62PLSBH Bulkhead Union - Metric Tube**

PART NO.	TUBE SIZE MM	F MM	F1 MM	L1 MM	L2 MM	T MM
62PLSBH-4M	4MM(5/32)	14	13	15	18	13
62PLSBH-6M	6	17	17	19	21	15
62PLSBH-8M	8MM(5/16)	19	19	20	22	17
62PLSBH-10M	10	22	22	24	26	21
62PLSBH-12M	12	24	24	25	26	23

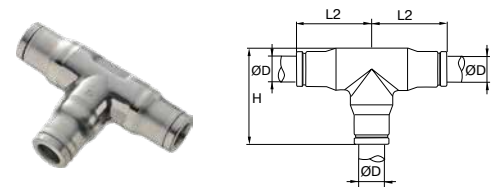

**164PLS Union Tee - Inch Tube**

PART NO.	TUBE SIZE IN	H IN	L2 IN
164PLS-4	1/4	1.06	.83
164PLS-6	3/8	1.48	1.12
164PLS-8	1/2	1.61	1.22

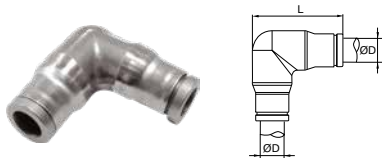

**165PLS Union Elbow - Inch Tube**

PART NO.	TUBE SIZE IN	L IN
165PLS-4	1/4	1.14
165PLS-6	3/8	1.56
165PLS-8	1/2	1.61

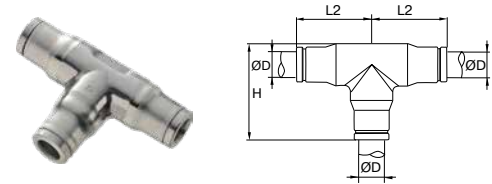

**164PLS Union Tee - Metric Tube**

PART NO.	TUBE SIZE MM	H MM	L2 MM
164PLS-4M	4MM(5/32)	24	19
164PLS-6M	6	30	24
164PLS-8M	8MM(5/16)	32	25
164PLS-10M	10	39	31
164PLS-12M	12	43	33

**WARNING** These products can expose you to chemicals including NICKEL, which is known to the state of California to cause cancer. For more information go to [www.P65Warnings.ca.gov](http://www.P65Warnings.ca.gov).



- A
- B
- C
- D
- E
- F
- G
- H
- I
- J
- K
- L
- M
- N
- O

Click here for CADs, Product Specifications or to Configure Parts Online

- A
- B
- C
- D
- E
- F
- G
- H
- I
- J
- K
- L
- M
- N
- O

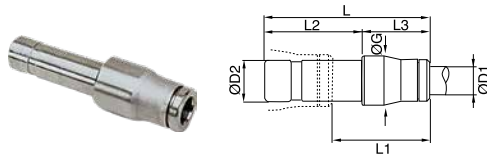

**67PLS Tube Reducer - Metric**

PART NO.	TUBE 1 SIZE MM	TUBE 2 SIZE MM	G MM	L MM	L1 MM	L2 MM	L3 MM
67PLS-4M-6M	4	6	10	35	19.0	19	16
67PLS-4M-8M	4	8	10	34	17.0	20	14
67PLS-6M-8M	6	8	12	42	24.0	23	19
67PLS-6M-10M	6	10	12	42	19.0	25	17
67PLS-8M-10M	8	10	15	45	22.5	25	19
67PLS-8M-12M	8	12	15	43	20.0	26	17
67PLS-10M-12M	10	12	17	51	23.0	26	25

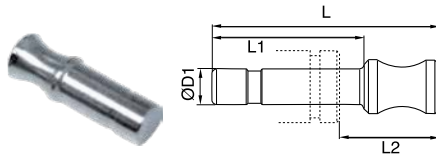

**639PLS Plug - Metric**

PART NO.	TUBE 1 SIZE MM	L MM	L1 MM	L2 MM
639PLS-4M	4	25.40	17.00	11.10
639PLS-6M	6	30.40	19.50	13.50
639PLS-8M	8	33.00	20.00	14.40
639PLS-10M	10	40.00	25.00	17.00
639PLS-12M	12	43.00	26.00	18.70

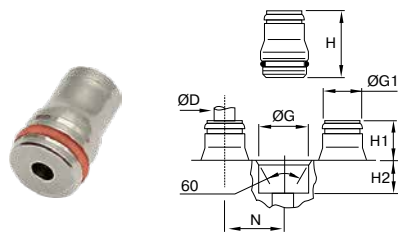

**PLSC Cartridge - Metric**

PART NO.	TUBE SIZE MM	G +.1 - 0 MM	G1 MM	H MM	H1 MM	H2 MM	N MM
PLSC-4M	4	9.80	8	18.00	9.50	8.50	11.00
PLSC-6M	6	12.10	10	20.00	11.50	8.50	13.50
PLSC-8M	8	14.80	13	22.00	13.50	8.50	16.00
PLSC-10M	10	17.50	15	25.50	15.00	10.50	20.00

**WARNING** These products can expose you to chemicals including NICKEL, which is known to the state of California to cause cancer. For more information go to [www.P65Warnings.ca.gov](http://www.P65Warnings.ca.gov).







# **Pneumatic: Integrated Fittings**

**Compact Flow Controls**

**Miniature Flow Controls**

**Swivel Outlet Flow Controls**

**Plug-In Flow Controls**

**In-Line Flow Controls**

**Metal Flow Controls**

**Brass Flow Controls**

**Stainless Steel Flow Controls**

**In-Line Check Valves**

**Stainless Steel Check Valves**

**Piloted Operated Check Valves**

**Pneumatic Slide Valves**

**Quick Exhaust Valve**

**Blocking Valves**

**Manually Operated Valves**

**Threshold Sensor Fittings**

**Mini Ball Valves**



**■ Compact Flow Controls**

**FCC731**  
Meter Out  
BSPT, BSPP  
p. B8



**FCCI731**  
Meter In  
BSPT, BSPP  
p. B8



**FCCB731**  
Bi-Directional  
BSPT, BSPP  
p. B9



**FCKC731**  
Meter Out  
Knobless BSPP  
p. B9



**FCKCI731**  
Meter In Knobless  
BSPP  
p. B10



**FCKCB731**  
Bi-Directional  
Knobless BSPP  
p. B10



**FCCS731**  
Meter Out  
p. B15



**FCMS731**  
Meter Out Miniature  
BSPP  
p. B15



**FCMSI731**  
Meter In Miniature  
BSPP  
p. B16



**FCCS731**  
Meter Out  
BSPP  
p. B16



**■ Miniature Flow Controls**

**FCM731**  
Meter Out  
BSPT, BSPP  
p. B12



**FCMI731**  
Meter In  
BSPT, BSPP  
p. B12, B13



**FCMB731**  
Bi-Directional  
BSPP  
p. B13



**FCMK731**  
Meter Out  
Knobless  
p. B13



**■ Plug-In Flow Controls**

**FCMSP731**  
Meter Out  
Miniature  
p. B18



**FCMSPI731**  
Meter In  
Miniature  
p. B18



**FCMSPI731**  
Meter In  
Miniature  
p. B18



**FCCSP731**  
Meter Out  
Compact  
p. B18



**FCCSPI731**  
Meter In  
Compact  
p. B18



**■ In-Line Flow Controls**

**FC832**  
In-Line  
p. B20



**FCB832**  
Bi-Directional  
p. B20



**FCPM832**  
Panel Mountable  
p. B21



**FC836**  
Threaded In-Line  
BSPP  
p. B21



**■ Metal Flow Controls**

**FC701**  
Meter Out  
BSPP  
p. B23



**FCI701**  
Meter In  
BSPP  
p. B23



**FCK701C**  
Knobless  
Compression  
Metal BSPP  
p. B23



**FC702**  
Meter Out  
BSPP  
p. B23



**FCI702**  
Meter In  
BSPP  
p. B23



**FC705**  
Meter Out  
p. B23



**FC708**  
Meter Out  
p. B23



**⚠ WARNING** These products can expose you to chemicals including NICKEL or LEAD, which are known to the state of California to cause cancer, and LEAD which is known to cause birth defects or other reproductive harm. For more information go to [www.P65Warnings.ca.gov](http://www.P65Warnings.ca.gov).



■ Brass Flow Controls

**FC703**

Threaded Port  
Meter Out Metal  
Flow Control – NPT  
p. B24



**FC703**

Threaded Port  
Meter Out Metal  
Flow Control – BSPP  
p. B24



**FC703**

Push-To-Connect  
Meter Out Metal  
Flow Control – NPT  
p. B25



■ Stainless Steel Flow Controls

**7810, 7815**

Meter Out  
NPT  
p. B27



**7812, 7817**

Bi-Directional NPT  
p. B27



**7810**

Meter Out  
BSPP  
p. B27



**7812**

Bi-Directional  
BSPP  
p. B27



**7835**

Meter Out NPT  
p. B27



■ Check Valves

**32PLCK**

In-Line  
p. B29



**W68PLCK**

Meter Out  
BSPT  
p. B29



**W68PLCKI**

Meter In  
BSPT  
p. B29



**68PLCK**

Meter Out  
BSPP  
p. B30



**68PLCKI**

Meter In  
BSPP  
p. B30



**VC**

Check Valve  
p. B30



■ Stainless Steel Check Valves

**4890**

Unidirectional  
BSPP  
p. B32



**4891**

Male x Female  
BSPP  
p. B32



**4892**

Female x Male  
BSPP  
p. B32



**4895**

Unidirectional  
NPT  
p. B32



■ Pilot Operated Check Valves

**7892**

BSPP  
p. B34



**7894**

Regulator &  
Exhaust BSPP  
p. B34



■ Pneumatic Slide Valves

**0660**

Female NPT  
p. B36



**0661**

Male x Female  
NPT  
p. B36



**0669**

Female BSPP  
p. B36



**⚠ WARNING** These products can expose you to chemicals including NICKEL or LEAD, which are known to the state of California to cause cancer, and LEAD which is known to cause birth defects or other reproductive harm. For more information go to [www.P65Warnings.ca.gov](http://www.P65Warnings.ca.gov).

- A
- B
- C
- D
- E
- F
- G
- H
- I
- J
- K
- L
- M
- N
- O

**Manually Operated 3-Way Venting Valves**

**7805/7806**  
p. B41



**7800/7801**  
p. B41



**Quick Exhaust**

**7970**  
BSPP  
p. B37



**7982**  
NPT  
p. B37



**Blocking Valves**

**FC601**  
Lock Out  
BSPT, BSPP  
p. B39



**FC602**  
Lock Out  
p. B39



**FC608**  
Lock Out  
BSPT, BSPP  
p. B39



**Threshold Sensor**

**PSBJ731**  
Pneumatic  
5/32 Pilot  
p. B43



**PSBJ731**  
Pneumatic  
4mm Pilot  
p. B43



**PSPJ731**  
Pneumatic  
10-32 Pilot  
p. B43



**PSBJ708**  
Pneumatic  
M5 Pilot  
p. B43



**PSPE731**  
Pneumatic /  
Electric  
BSPP  
p. B43



**Mini Ball Valve**

**MV308**  
Male BSPP  
p. B45



**MV309**  
Push-to-Connect  
Ports, Vented  
p. B45



**MVV308**  
Male BSPP,  
Vented  
p. B45



**MVV309**  
Push-to-Connect  
Ports  
p. B45



**WARNING** These products can expose you to chemicals including NICKEL or LEAD, which are known to the state of California to cause cancer, and LEAD which is known to cause birth defects or other reproductive harm. For more information go to [www.P65Warnings.ca.gov](http://www.P65Warnings.ca.gov).



A

B

C

D

E

F

G

H

I

J

K

L

M

N

O



# Compact Flow Controls

Parker's compact flow controls ensure excellent performance of flow and are perfectly suited for reduced spaces due to their small size.

## Product Features:

- Glass reinforced nylon 6.6 body
- Stainless steel gripping ring
- Nickel-plated brass adjustment screw
- Nickel-plated brass locking nut
- Nickel-plated brass threads
- Nitrile D seal
- NPT
- BSPT
- BSPP
- Metric threads

## Markets:

- Factory/Process Automation
- Life Science
- Food Processing
- Water And Beverage
- Petrochemical

## Applications:

- Packaging
- Filling
- Dispensing
- Bottling
- Pneumatic Circuits

## Specifications:

**Pressure Range** 15 to 145 psi (1.0 to 9.9 bar)

**Temperature Range** +32° to +158° F (0 to +70° C)

## Compatible Tubing:

- Semi-rigid nylon
- Polyurethane 95 Durometer Shore A
- Nylon
- Fluoropolymer

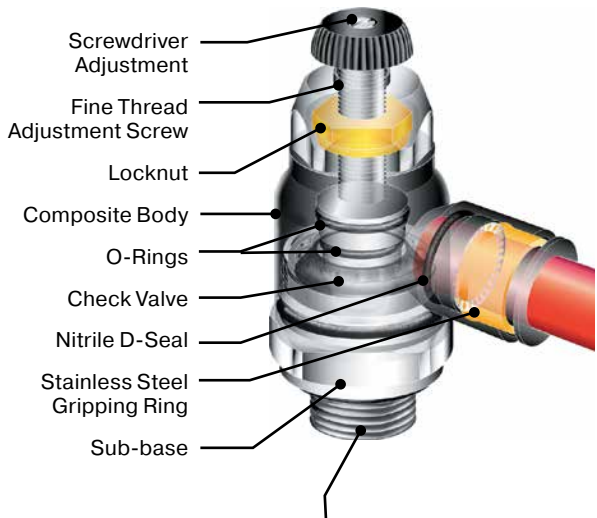

Sealing O-ring on BSPP  
Thread Sealant on NPT/BSPT

## Assembly Instructions

1. Cut tubing squarely – maximum of 15° angle allowable.
2. Check that port or mating part is clean and free of debris.
3. Mark tubing to appropriate tube insertion length. (see Tube Insertion Chart on page N22)
4. Insert tubing until it bottoms
5. Pull on tubing to verify it is fully inserted
6. To disassemble, simply press release button, hold against body and pull tubing out of fitting.

**WARNING** These products can expose you to chemicals including NICKEL or LEAD, which are known to the state of California to cause cancer, and LEAD which is known to cause birth defects or other reproductive harm. For more information go to [www.P65Warnings.ca.gov](http://www.P65Warnings.ca.gov).



Click here for CADs, Product Specifications or to Configure Parts Online

- A
- B
- C
- D
- E
- F
- G
- H
- I
- J
- K
- L
- M
- N
- O

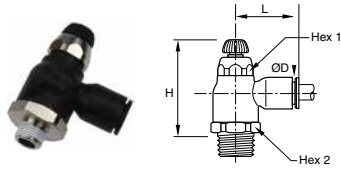

### FCC731 Compact Meter Out

PART NO.	TUBE SIZE IN	NPT	HEX 1	HEX 2	H OPEN	H CLOSED	L
FCC731-4M-2	5/32(4MM)	1/8	.63	.39	1.67	1.44	.85
FCC731-4M-4	5/32(4MM)	1/4	.63	.39	1.67	1.44	.85
FCC731-4-2	1/4	1/8	.63	.39	1.67	1.44	.85
FCC731-4-4	1/4	1/4	.63	.39	1.67	1.44	.85
FCC731-6-4	3/8	1/4	.91	.67	2.03	1.71	1.22
FCC731-6-6	3/8	3/8	.91	.67	2.03	1.71	1.22
FCC731-6-8	3/8	1/2	.67	.91	2.03	1.71	1.22
FCC731-8-8	1/2	1/2	.67	.91	2.03	1.71	1.22

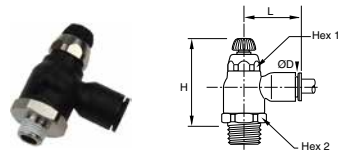

### FCC731 Compact Meter Out - BSPT

PART NO.	TUBE SIZE MM	BSPT	HEX 1	HEX 2	H CLOSED	H OPEN	L
FCC731-6M-2R	6	1/8	16	10	36.5	42.5	22.0
FCC731-8M-2R	8	1/8	19	14	40.0	45.0	27.0
FCC731-8M-4R	8	1/4	19	14	40.0	45.0	27.0
FCC731-10M-4R	10	1/4	23	17	43.5	51.5	31.5
FCC731-10M-6R	10	3/8	23	17	43.5	51.5	31.5
FCC731-10M-8R	10	1/2	23	17	43.5	51.5	31.5
FCC731-12M-4R	12	1/4	23	17	43.5	51.5	35.0
FCC731-12M-6R	12	3/8	23	17	43.5	51.5	35.0
FCC731-12M-8R	12	1/2	23	17	43.5	51.5	35.0

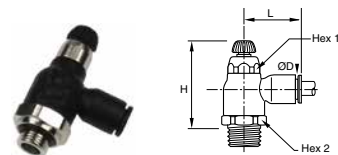

### FCC731 Compact Meter Out - BSPP

PART NO.	TUBE SIZE MM	BSPP	HEX 1	HEX 2	H CLOSED	H OPEN	L
FCC731-4M-2G	4	1/8	10	16	38.0	44.0	22.0
FCC731-6M-2G	6	1/8	10	16	38.0	44.0	22.0
FCC731-6M-4G	6	1/4	10	16	36.5	42.5	22.0
FCC731-8M-2G	8	1/8	14	19	41.5	48.0	28.0
FCC731-8M-4G	8	1/4	14	19	41.5	48.0	28.0
FCC731-8M-6G	8	3/8	14	19	41.5	48.0	28.0
FCC731-10M-4G	10	1/4	17	23	45.5	53.5	31.5
FCC731-10M-6G	10	3/8	17	23	45.5	54.0	31.5
FCC731-12M-6G	12	3/8	17	23	45.5	54.0	35.0
FCC731-12M-8G	12	1/2	17	24	45.5	54.0	35.0

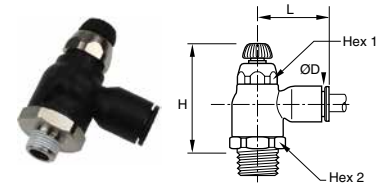

### FCCI731 Compact Meter In Flow Control

PART NO.	TUBE SIZE IN	NPT	HEX 1	HEX 2	H OPEN	H CLOSED	L
FCCI731-4M-2	5/32(4MM)	1/8	.63	.39	1.67	1.44	.85
FCCI731-4M-4	5/32(4MM)	1/4	.63	.39	1.67	1.44	.85
FCCI731-4-2	1/4	1/8	.63	.39	1.67	1.44	.85
FCCI731-4-4	1/4	1/4	.63	.39	1.67	1.44	.85

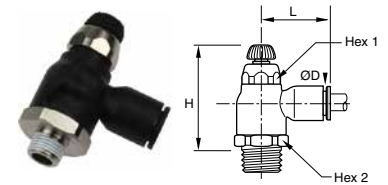

### FCCI731 Compact Meter In Flow Control - BSPT

PART NO.	TUBE SIZE MM	BSPT	HEX 1	HEX 2	H CLOSED	H OPEN	L
FCCI731-10M-4R	10	1/4	23	17	43.5	51.5	31.5
FCCI731-10M-8R	10	1/2	23	17	43.5	51.5	31.5

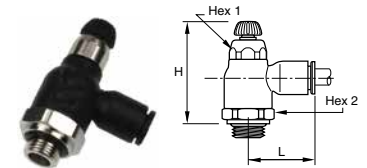

### FCCI731 Compact Meter In Flow Control - BSPP

PART NO.	TUBE SIZE MM	BSPP	HEX 1	HEX 2	H CLOSED	H OPEN	L
FCCI731-4M-2G	4	1/8	10	16	38.0	44.0	22.0
FCCI731-6M-2G	6	1/8	10	16	38.0	44.0	22.0
FCCI731-6M-4G	6	1/4	10	16	36.5	42.5	22.0
FCCI731-8M-2G	8	1/8	14	19	41.5	48.0	28.0
FCCI731-8M-4G	8	1/4	14	19	41.5	48.0	28.0
FCCI731-8M-6G	8	3/8	14	19	41.5	48.0	28.0
FCCI731-10M-4G	10	1/4	17	23	45.5	53.5	31.5
FCCI731-10M-6G	10	3/8	17	23	45.5	54.0	31.5
FCCI731-12M-8G	12	1/2	17	24	45.5	54.0	35.0

**WARNING** These products can expose you to chemicals including NICKEL or LEAD, which are known to the state of California to cause cancer, and LEAD which is known to cause birth defects or other reproductive harm. For more information go to [www.P65Warnings.ca.gov](http://www.P65Warnings.ca.gov).

Click here for CADs, Product Specifications or to Configure Parts Online

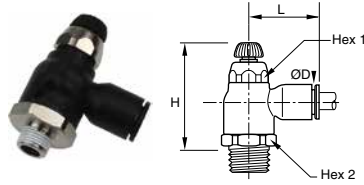

### FCCB731 Compact Bi-Directional Flow Control

PART NO.	TUBE SIZE IN	NPT	HEX 1	HEX 2	H OPEN	H CLOSED	L
FCCB731-4M-2	5/32(4MM)	1/8	.63	.39	1.67	1.44	.85
FCCB731-4-2	1/4	1/8	.63	.39	1.67	1.44	.85
FCCB731-4-4	1/4	1/4	.63	.39	1.67	1.44	.85

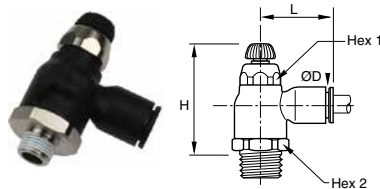

### FCCB731 Compact Bi-Directional Flow Control - BSPT

PART NO.	TUBE SIZE MM	BSPT	HEX 1	HEX 2	H CLOSED	H OPEN	L
FCCB731-4M-2R	4	1/8	16	10	36.5	42.5	22.0
FCCB731-6M-2R	6	1/8	16	10	36.5	42.5	22.0
FCCB731-6M-4R	6	1/4	16	10	36.5	42.5	22.0
FCCB731-8M-2R	8	1/8	19	14	40.0	45.0	27.0
FCCB731-8M-4R	8	1/4	19	14	40.0	45.0	27.0
FCCB731-8M-6R	8	3/8	19	14	40.0	45.0	27.0

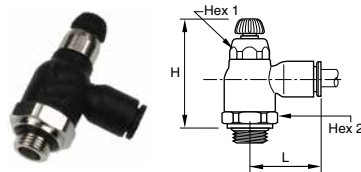

### FCCB731 Compact Bi-Directional Flow Control - BSPP

PART NO.	TUBE SIZE MM	BSPP	HEX 1	HEX 2	H CLOSED	H OPEN	L
FCCB731-4M-2G	4	1/8	10	16	38.0	44.0	22.0
FCCB731-6M-2G	6	1/8	10	16	38.0	44.0	22.0
FCCB731-6M-4G	6	1/4	10	16	36.5	42.5	22.0
FCCB731-8M-2G	8	1/8	14	19	41.5	48.0	28.0
FCCB731-8M-4G	8	1/4	14	19	41.5	48.0	28.0
FCCB731-8M-6G	8	3/8	14	19	41.5	48.0	28.0

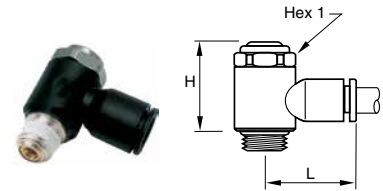

### FCKC731 Knobless Meter Out Flow Control

ART NO.	TUBE SIZE IN	NPT / UNF	HEX 1 MM	H	L
FCKC731-2-0	1/8	10-32		.69	.65
FCKC731-2-2	1/8	1/8	13	.79	.75
FCKC731-4M-0	5/32(4MM)	10-32		.69	.65
FCKC731-4M-2	5/32(4MM)	1/8	13	.79	.75
FCKC731-4-0	1/4	10-32		.69	.77
FCKC731-4-2	1/4	1/8	13	.79	.85
FCKC731-4-4	1/4	1/4	17	1.04	.89
FCKC731-8M-2	5/16(8MM)	1/8	13	.79	1.02
FCKC731-8M-4	5/16(8MM)	1/4	17	1.04	1.06
FCKC731-6-4	3/8	1/4	17	1.04	1.14
FCKC731-6-6	3/8	3/8	20	1.14	1.36

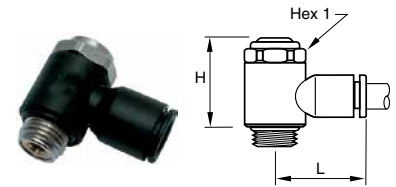

### FCKC731 Knobless Compact Flow Control - BSPP

PART NO.	TUBE SIZE MM	BSPP / M5	HEX 1	H	L
FCKC731-4M-M5	4	M5X0.8	8.0	17.5	17.0
FCKC731-4M-2G	4	1/8	13.0	25.0	19.0
FCKC731-6M-M5	6	M5X0.8	8.0	17.5	19.0
FCKC731-6M-2G	6	1/8	13.0	25.0	21.0
FCKC731-6M-4G	6	1/4	17.0	26.5	22.0
FCKC731-8M-2G	8	1/8	13.0	25.0	26.0
FCKC731-8M-4G	8	1/4	17.0	26.5	27.0
FCKC731-8M-6G	8	3/8	20.0	37.5	29.0
FCKC731-10M-4G	10	1/4	17.0	26.5	29.0
FCKC731-10M-6G	10	3/8	20.0	37.5	31.0
FCKC731-10M-8G	10	1/2	23.0	43.0	37.0
FCKC731-12M-6G	12	3/8	20.0	37.5	6.8
FCKC731-12M-8G	12	1/2	23.0	43.0	37.0

**WARNING** These products can expose you to chemicals including NICKEL or LEAD, which are known to the state of California to cause cancer, and LEAD which is known to cause birth defects or other reproductive harm. For more information go to [www.P65Warnings.ca.gov](http://www.P65Warnings.ca.gov).



Click here for CADs, Product Specifications or to Configure Parts Online

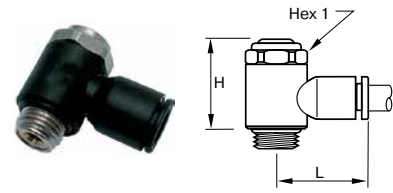
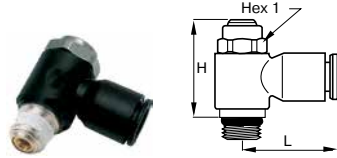

**FCKCI731 Knobless Meter In Flow Control**

PART NO.	TUBE SIZE IN	NPT / UNF	HEX 1 MM	H	L
FCKCI731-4M-2	5/32(4MM)	1/8	13	.79	.75
FCKCI731-4-2	1/4	1/8	13	.79	.85

**FCKCB731 Knobless Bi-directional Flow Control - BSPP**

PART NO.	TUBE SIZE MM	BSPP / M5	HEX 1	H	L
FCKCB731-4M-M5	4	M5X0.8	8	17.5	17.0
FCKCB731-4M-2G	4	1/8	13	25.0	19.0
FCKCB731-6M-M5	6	M5X0.8	8	17.5	19.0
FCKCB731-6M-2G	6	1/8	13	25.0	21.0
FCKCB731-6M-4G	6	1/4	17	26.5	22.0
FCKCB731-8M-2G	8	1/8	13	25.0	26.0
FCKCB731-8M-4G	8	1/4	17	26.5	27.0
FCKCB731-8M-6G	8	3/8	20	37.5	29.0

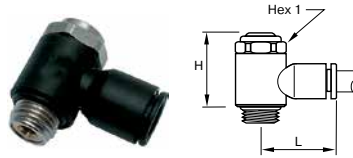

**FCKCI731 Knobless Compact Meter In Flow Control-BSPP**

PART NO.	TUBE SIZE MM	BSPP / M5	HEX 1	H	L
FCKCI731-4M-M5	4	M5X0.8	8.0	17.5	17.0
FCKCI731-4M-2G	4	1/8	13.0	25.0	19.0
FCKCI731-6M-M5	6	M5X0.8	8.0	17.5	19.0
FCKCI731-6M-2G	6	1/8	13.0	25.0	21.0
FCKCI731-6M-4G	6	1/4	17.0	26.5	22.0
FCKCI731-8M-2G	8	1/8	13.0	25.0	26.0
FCKCI731-8M-4G	8	1/4	17.0	26.5	27.0
FCKCI731-8M-6G	8	3/8	20.0	37.5	29.0
FCKCI731-10M-4G	10	1/4	17.0	26.5	29.0
FCKCI731-10M-6G	10	3/8	20.0	37.5	31.0

**WARNING** These products can expose you to chemicals including NICKEL or LEAD, which are known to the state of California to cause cancer, and LEAD which is known to cause birth defects or other reproductive harm. For more information go to [www.P65Warnings.ca.gov](http://www.P65Warnings.ca.gov).



A

B

C

D

E

F

G

H

I

J

K

L

M

N

O

# Miniature Flow Controls



Parker's miniature flow controls ensure excellent performance of flow and are perfectly suited for reduced spaces due to their small size.

## Product Features:

- Glass reinforced nylon 6.6 body
- Stainless steel gripping ring
- Nickel-plated brass adjustment screw
- Nickel-plated brass locking nut
- Nickel-plated brass threads
- Nitrile D seal
- NPT, BSPT, BSPP, Metric threads

## Markets:

- Factory/Process Automation
- Life Science
- Food Processing
- Water And Beverage
- Petrochemical

## Applications:

- Packaging
- Filling
- Dispensing
- Bottling
- Pneumatic Circuits

## Specifications:

**Pressure Range** 15 to 145 psi (1.0 to 9.9 bar)

**Temperature Range** +32° to +158° F (0 to +70° C)

## Compatible Tubing:

- Semi-rigid nylon
- Polyurethane 95 Durometer Shore A
- Nylon
- Fluoropolymer

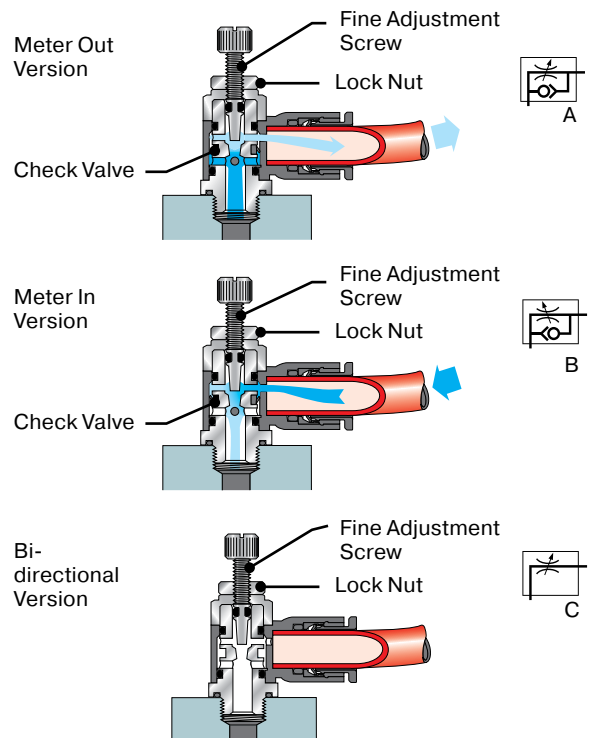

## Assembly Instructions

1. Cut tubing squarely – maximum of 15° angle allowable.
2. Check that port or mating part is clean and free of debris.
3. Mark tubing to appropriate tube insertion length. (see Tube Insertion Chart on page N22)
4. Insert tubing until it bottoms
5. Pull on tubing to verify it is fully inserted
6. To disassemble, simply press release button, hold against body and pull tubing out of fitting.

**WARNING** These products can expose you to chemicals including NICKEL or LEAD, which are known to the state of California to cause cancer, and LEAD which is known to cause birth defects or other reproductive harm. For more information go to [www.P65Warnings.ca.gov](http://www.P65Warnings.ca.gov).



Click here for CADs, Product Specifications or to Configure Parts Online

- A
- B
- C
- D
- E
- F
- G
- H
- I
- J
- K
- L
- M
- N
- O

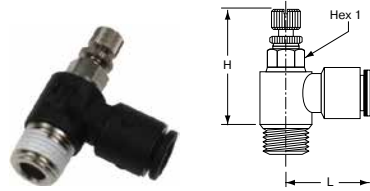

**FCM731 Miniature Meter Out Flow Control**

PART NO.	TUBE SIZE IN	NPT	HEX 1 MM	H OPEN	H CLOSED	L
FCM731-2-0	1/8	10-32	6	1.14	.91	.67
FCM731-2-2	1/8	1/8	7	1.41	1.26	.69
FCM731-5/32-0	5/32	10-32	6	1.02	.93	.67
FCM731-5/32-2	5/32	1/8	7	1.16	1.06	.71
FCM731-4-0	1/4	10-32	6	1.02	.93	.73
FCM731-4-2	1/4	1/8	7	1.16	1.06	.75
FCM731-4-4	1/4	1/4	8	1.28	1.18	.77



**FCMI731 Miniature Meter In Flow Control - BSPT**

PART NO.	TUBE SIZE MM	BSPT	HEX 1	H CLOSED	H OPEN	L
FCMI731-4M-2R	4	1/8	7	25.0	27.5	18.0
FCMI731-6M-2R	6	1/8	7	25.0	27.5	18.5
FCMI731-6M-4R	6	1/4	8	27.5	30.0	19.0
FCMI731-8M-2R	8	1/8	13	28.5	33.0	26.0
FCMI731-8M-4R	8	1/4	16	31.0	35.0	27.5

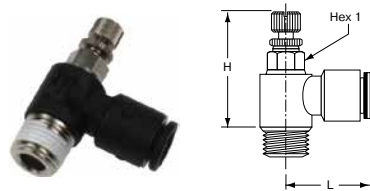

**FCMI731 Miniature Meter In Flow Control**

PART NO.	TUBE SIZE IN	NPT	HEX 1 MM	H OPEN	H CLOSED	L
FCMI731-2-0	1/8	10-32	6	1.14	.91	.67
FCMI731-5/32-0	5/32	10-32	6	1.02	.93	.67
FCMI731-5/32-2	5/32	1/8	7	1.16	1.06	.71
FCMI731-4-0	1/4	10-32	6	1.02	.93	.73
FCMI731-4-2	1/4	1/8	7	1.16	1.06	.75
FCMI731-4-4	1/4	1/4	8	1.28	1.18	.77

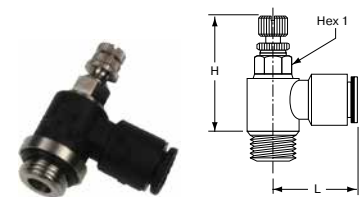

**FCM731 Miniature Meter Out Flow Control - BSPP**

PART NO.	TUBE SIZE MM	BSPP	HEX 1	H CLOSED	H OPEN	L
FCM731-3M-M3	3	M3X0.5	6	23.5	26.0	17.0
FCM731-3M-M5	3	M5X0.8	6	23.5	26.0	17.0
FCM731-4M-M3	4	M3X0.5	6	23.5	26.0	16.5
FCM731-4M-M5	4	M5X0.8	6	23.5	26.0	17.0
FCM731-4M-2G	4	1/8	7	27.0	29.5	18.0
FCM731-6M-M5	6	M5X0.8	6	23.5	26.0	18.0
FCM731-6M-2G	6	1/8	7	27.0	29.5	18.5
FCM731-6M-4G	6	1/4	8	30.0	32.5	19.0
FCM731-8M-2G	8	1/8	13	26.5	31.0	26.0
FCM731-8M-4G	8	1/4	16	29.0	34.0	27.5
FCM731-8M-6G	8	3/8	20	36.0	42.0	29.0

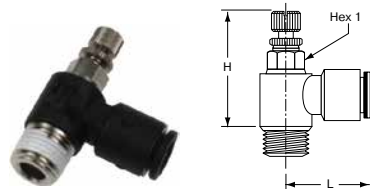

**FCM731 Miniature Meter Out Flow Control - BSPT**

PART NO.	TUBE SIZE MM	BSPT	HEX 1	H CLOSED	H OPEN	L
FCM731-4M-2R	4	1/8	7	25.0	27.5	18.0
FCM731-6M-2R	6	1/8	7	25.0	27.5	18.5
FCM731-6M-4R	6	1/4	8	27.5	30.0	19.0
FCM731-6M-6R	6	3/8	17	31.5	34.0	19.0
FCM731-8M-2R	8	1/8	13	28.5	33.0	26.0
FCM731-8M-4R	8	1/4	16	31.0	35.0	27.5
FCM731-8M-6R	8	3/8	20	36.0	42.0	29.0

**WARNING** These products can expose you to chemicals including NICKEL or LEAD, which are known to the state of California to cause cancer, and LEAD which is known to cause birth defects or other reproductive harm. For more information go to [www.P65Warnings.ca.gov](http://www.P65Warnings.ca.gov).





Click here for CADs, Product Specifications or to Configure Parts Online

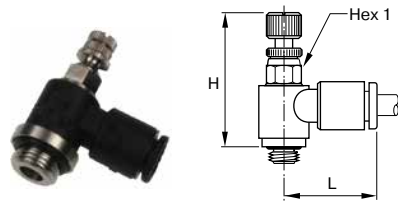

**FCMI731 Miniature Meter In Flow Control - BSPP**

PART NO.	TUBE SIZE MM	BSPP	HEX 1	H CLOSED	H OPEN	L
FCMI731-3M-M3	3	M3X0.5	6	23.5	26.0	17.0
FCMI731-3M-M5	3	M5X0.8	6	23.5	26.0	17.0
FCMI731-4M-M5	4	M5X0.8	6	23.5	26.0	17.0
FCMI731-4M-2G	4	1/8	7	27.0	29.5	18.0
FCMI731-6M-M5	6	M5X0.8	6	23.5	26.0	18.0
FCMI731-6M-2G	6	1/8	7	27.0	29.5	18.5
FCMI731-6M-4G	6	1/4	8	30.0	32.5	19.0
FCMI731-8M-2G	8	1/8	13	26.5	31.0	26.0
FCMI731-8M-4G	8	1/4	16	29.0	34.0	27.5
FCMI731-8M-6G	8	3/8	20	36.0	42.0	29.0

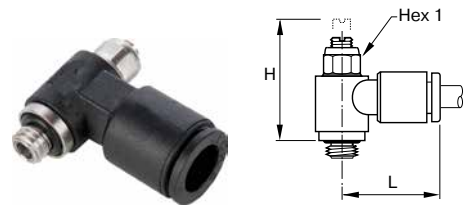

**FCMK731 Knobless Mini Meter Out Flow Control**

PART NO.	TUBE SIZE IN	NPT	HEX 1 MM	H OPEN	H CLOSED	L
FCMK731-2-0	1/8	10-32	6	.79	.65	.65
FCMK731-2-2	1/8	1/8	6	.85	.71	.71
FCMK731-5/32-0	5/32	10-32	6	.79	.65	.65
FCMK731-5/32-2	5/32	1/8	6	.85	.71	.71
FCMK731-4-0	1/4	10-32	6	.79	.65	.65
FCMK731-4-2	1/4	1/8	6	.85	.71	.73
FCMK731-4-4	1/4	1/4	6	.97	.83	.73

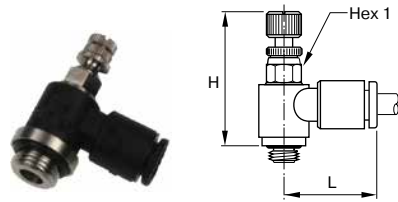

**FCMB731 Miniature Bi-directional Flow Control - BSPP**

PART NO.	TUBE SIZE MM	BSPP	HEX 1	H CLOSED	H OPEN	L
FCMB731-4M-M5	4	M5X0.8	6	23.5	26.0	16.5
FCMB731-4M-2G	4	1/8	7	27.0	29.5	17.0
FCMB731-6M-M5	6	M5X0.8	6	23.5	26.0	18.0
FCMB731-6M-2G	6	1/8	7	27.0	29.5	18.0
FCMB731-6M-4G	6	1/4	8	30.0	32.5	18.5

**WARNING** These products can expose you to chemicals including NICKEL or LEAD, which are known to the state of California to cause cancer, and LEAD which is known to cause birth defects or other reproductive harm. For more information go to [www.P65Warnings.ca.gov](http://www.P65Warnings.ca.gov).



- A
- B
- C
- D
- E
- F
- G
- H
- I
- J
- K
- L
- M
- N
- O

A

B

C

D

E

F

G

H

I

J

K

L

M

N

O



# Swivel Outlet Flow Controls

Parker's swivel outlet flow controls are designed to allow a vertical or angled tube exit where access is restricted.

## Product Features:

- Glass reinforced nylon 6.6 body
- Stainless steel gripping ring
- Nickel-plated brass adjustment screw
- Nickel-plated brass locking nut
- Nickel-plated brass threads
- Nitrile D seal
- NPT, BSPT, BSPP, Metric threads

## Markets:

- Factory/Process Automation
- Life Science
- Food Processing
- Water And Beverage
- Petrochemical

## Applications:

- Packaging
- Filling
- Dispensing
- Bottling
- Pneumatic Circuits

## Specifications:

**Pressure Range** 15 to 145 psi (1.0 to 9.9 bar)

**Temperature Range** +32° to +158° F (0 to +70° C)

## Compatible Tubing:

- Semi-rigid nylon
- Polyurethane 95 Durometer Shore A
- Nylon
- Fluoropolymer

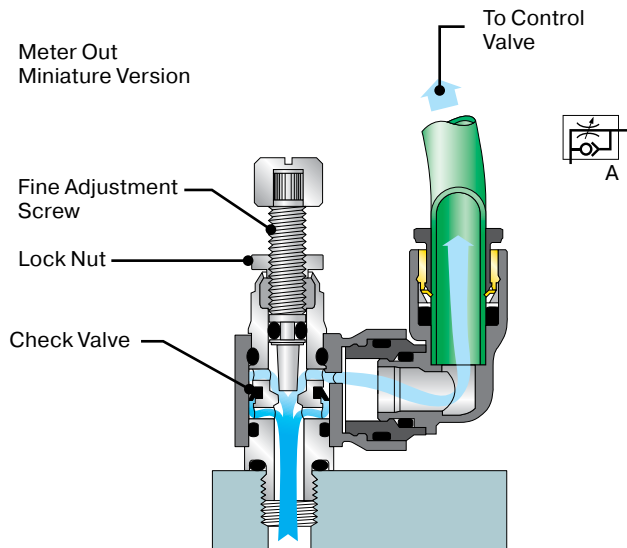

## Assembly Instructions

1. Cut tubing squarely – maximum of 15° angle allowable.
2. Check that port or mating part is clean and free of debris.
3. Mark tubing to appropriate tube insertion length. (see Tube Insertion Chart on page N22)
4. Insert tubing until it bottoms
5. Pull on tubing to verify it is fully inserted
6. To disassemble, simply press release button, hold against body and pull tubing out of fitting.



**WARNING** These products can expose you to chemicals including NICKEL or LEAD, which are known to the state of California to cause cancer, and LEAD which is known to cause birth defects or other reproductive harm. For more information go to [www.P65Warnings.ca.gov](http://www.P65Warnings.ca.gov).



[Click here for CADs, Product Specifications or to Configure Parts Online](#)

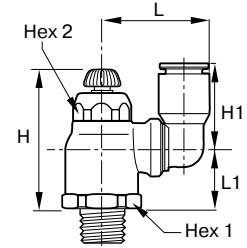

**FCCS731 Compact Swivel Outlet Meter Out Flow Control**

PART NO.	TUBE SIZE IN	NPT	HEX 1 MM	HEX 2 MM	H CLOSED	H OPEN	H1	L	L1
FCCS731-4-2	1/4	1/8	19	10	1.87	2.09	.63	.93	.65
FCCS731-4-4	1/4	1/4	19	14	1.79	1.99	.73	1.00	.89
FCCS731-6-4	3/8	1/4	23	17	1.93	2.20	1.04	1.34	.97
FCCS731-6-6	3/8	3/8	23	17	1.93	2.20	1.04	1.34	.97

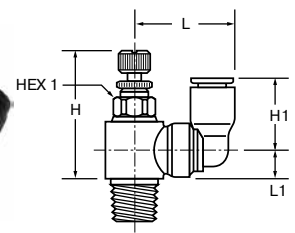

**FCMS731 Mini Swivel Outlet Meter Out Flow Control**

PART NO.	TUBE SIZE IN	NPT	HEX 1 MM	H CLOSED	H OPEN	H1	L	L1
FCMS731-4M-0	5/32 (4MM)	10-32	6	.96	1.08	.55	0.73	0.26
FCMS731-4M-2	5/32 (4MM)	1/8	8	1.08	1.20	.55	0.73	0.33

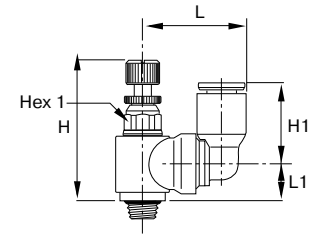

**FCMS731 Miniature Swivel Outlet Meter Out - BSPP**

PART NO.	TUBE SIZE MM	BSPP	HEX 1	H CLOSED	H OPEN	H1	L	L1
FCMS731-4M-M5	4	M5X0.8	6	24.5	27.5	14.5	19.5	6.5
FCMS731-4M-2G	4	1/8	7	27.5	31.0	14.5	20.0	8.5
FCMS731-6M-M5	6	M5X0.8	6	24.5	27.5	16.0	21.5	6.5
FCMS731-6M-2G	6	1/8	7	27.5	31.0	16.0	22.0	8.5

**WARNING** These products can expose you to chemicals including NICKEL or LEAD, which are known to the state of California to cause cancer, and LEAD which is known to cause birth defects or other reproductive harm. For more information go to [www.P65Warnings.ca.gov](http://www.P65Warnings.ca.gov).



- A
- B
- C
- D
- E
- F
- G
- H
- I
- J
- K
- L
- M
- N
- O

[Click here for CADs, Product Specifications or to Configure Parts Online](#)

A

B

C

D

E

F

G

H

I

J

K

L

M

N

O

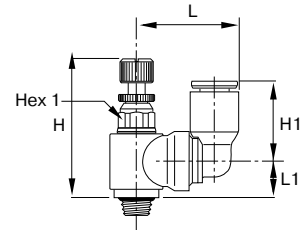

**FCMSI731 Miniature Swivel Outlet Meter In - BSPP**

PART NO.	TUBE SIZE MM	BSPP	HEX 1	H CLOSED	H OPEN	H1	L	L1
FCMSI731-4M-M5	4	M5X0.8	6	24.5	27.5	14.5	19.5	6.5
FCMSI731-6M-M5	6	M5X0.8	6	24.5	27.5	16.0	21.5	6.5
FCMSI731-6M-2G	6	1/8	7	27.5	31.0	16.0	22.0	8.5

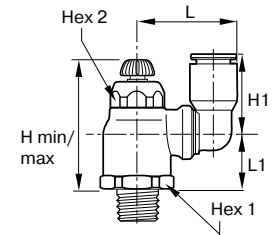

**FCCS731 Compact Swivel Outlet - BSPP**

PART NO.	TUBE SIZE MM	BSPP	HEX 1	HEX 2	H CLOSED	H OPEN	H1	L	L1
FCCS731-6M-2G	6	1/8	16	10	38.0	44.0	16.0	23.5	18.0
FCCS731-6M-4G	6	1/4	16	10	36.5	42.5	16.0	23.5	16.5
FCCS731-8M-2G	8	1/8	19	14	41.5	48.0	23.0	28.0	19.0
FCCS731-8M-4G	8	1/4	19	14	41.5	48.0	23.0	28.0	19.5
FCCS731-8M-6G	8	3/8	19	14	41.5	48.0	23.0	28.0	17.5
FCCS731-10M-4G	10	1/4	23	17	45.5	53.5	26.5	35.0	21.0
FCCS731-10M-6G	10	3/8	23	17	45.5	54.0	26.5	35.0	21.5
FCCS731-12M-6G	12	3/8	23	17	45.5	54.0	31.0	38.0	21.5
FCCS731-12M-8G	12	1/2	23	17	45.5	54.0	31.0	38.0	21.0

**WARNING** These products can expose you to chemicals including NICKEL or LEAD, which are known to the state of California to cause cancer, and LEAD which is known to cause birth defects or other reproductive harm. For more information go to [www.P65Warnings.ca.gov](http://www.P65Warnings.ca.gov).



A

B

C

D

E

F

G

H

I

J

K

L

M

N

O

# Plug-In Flow Controls



Parker's Plug-in flow controls can be directly mounted into existing fittings and allow very compact installations. They are particularly suited for mounting in manifolds using cartridges.

## Product Features:

- Glass reinforced nylon 6.6 body
- Stainless steel gripping ring
- Nickel-plated brass adjustment screw
- Nickel-plated brass locking nut
- Nickel-plated tailpiece
- Nitrile D seal

## Markets:

- Factory/Process Automation
- Life Science
- Food Processing
- Water And Beverage
- Petrochemical

## Applications:

- Packaging
- Filling
- Dispensing
- Bottling
- Pneumatic Circuits

## Specifications:

**Pressure Range** 15 to 145 psi (1.0 to 9.9 bar)

**Temperature Range** +32° to +158° F (0 to +70° C)

## Compatible Tubing:

- Semi-rigid nylon
- Polyurethane 95 Durometer Shore A
- Nylon
- Fluoropolymer

## Miniature

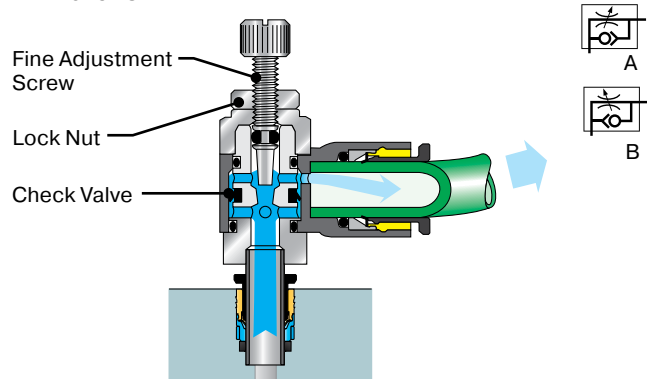

## Compact

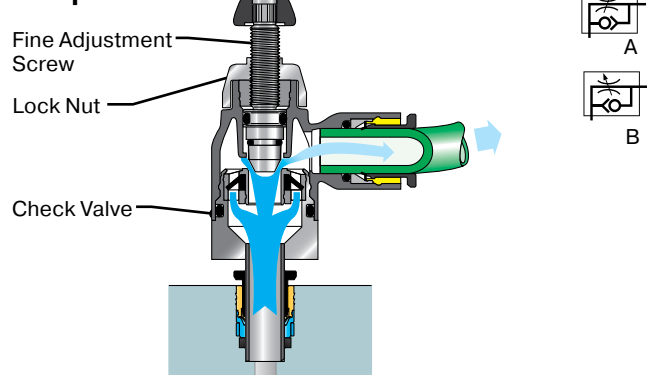

## Assembly Instructions

1. Cut tubing squarely – maximum of 15° angle allowable.
2. Check that port or mating part is clean and free of debris.
3. Mark tubing to appropriate tube insertion length. (see Tube Insertion Chart on page N22)
4. Insert tubing until it bottoms
5. Pull on tubing to verify it is fully inserted
6. To disassemble, simply press release button, hold against body and pull tubing out of fitting.

**WARNING** These products can expose you to chemicals including NICKEL or LEAD, which are known to the state of California to cause cancer, and LEAD which is known to cause birth defects or other reproductive harm. For more information go to [www.P65Warnings.ca.gov](http://www.P65Warnings.ca.gov).



Click here for CADs, Product Specifications or to Configure Parts Online

- A
- B
- C
- D
- E
- F
- G
- H
- I
- J
- K
- L
- M
- N
- O

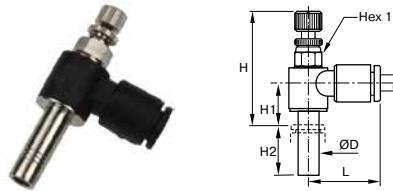

**FCMSP731 Plug-In Mini Meter Out Flow Control**

PART NO.	TUBE SIZE IN	HEX 1 MM	H OPEN	H CLOSED	H1	H2	L
FCMSP731-2	1/8	6	1.04	.94	.12	.59	0.67
FCMSP731-4	1/4	7	1.18	1.08	.12	.73	0.73

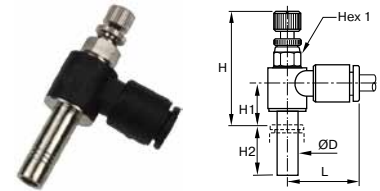

**FCMSP1731 Plug-In Mini Meter In Flow Control**

PART NO.	TUBE SIZE MM	HEX 1	H CLOSED	H OPEN	H1	H2	L
FCMSP1731-4M (5/32)	4	6	25.5	28.0	9.5	15.5	17.0
FCMSP1731-6M	6	7	27.5	29.0	10.5	17.0	18.5

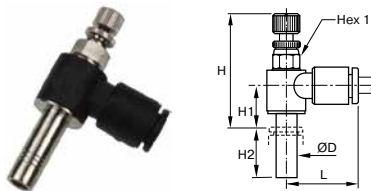

**FCMSP1731 Plug-In Mini Meter In Flow Control**

PART NO.	TUBE SIZE IN	HEX 1 MM	H OPEN	H CLOSED	H1	H2	L
FCMSP1731-2	1/8	6	1.04	.94	.12	0.59	0.67
FCMSP1731-4	1/4	7	1.18	1.08	.12	0.73	0.73

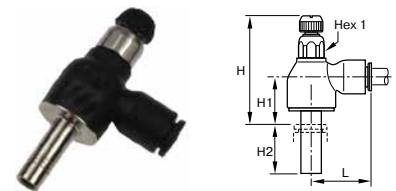

**FCCSP731 Plug-In Compact Meter Out Flow Control**

PART NO.	TUBE SIZE MM	HEX 1	H CLOSED	H OPEN	H1	H2	L
FCCSP731-6M	6	10	35.0	41.0	14.0	17.0	22.0
FCCSP731-8M	8	14	39.5	46.5	16.0	21.5	28.0
FCCSP731-12M	12	17	43.0	51.0	17.0	27.0	31.5

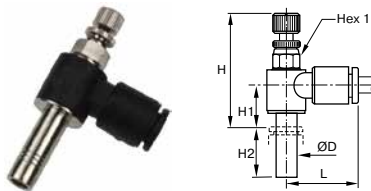

**FCMSP731 - Plug-In Miniature Meter Out Flow Control**

PART NO.	TUBE SIZE MM	HEX 1	H CLOSED	H OPEN	H1	H2	L
FCMSP731-4M (5/32)	4	6	25.5	28.0	9.5	15.5	17.0
FCMSP731-6M	6	7	27.5	29.0	10.5	17.0	18.5

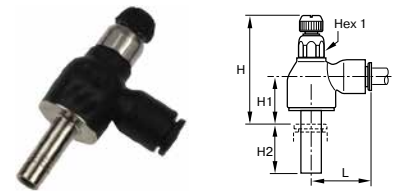

**FCCSPI731 Plug-In Compact Meter-In Flow Control**

PART NO.	TUBE SIZE MM	HEX 1	H CLOSED	H OPEN	H1	H2	L
FCCSPI731-6M	6	10	35.0	41.0	14.0	17.0	22.0
FCCSPI731-8M	8	14	39.5	46.5	16.0	21.5	28.0
FCCSPI731-12M	12	17	43.0	51.0	17.0	27.0	31.5

**WARNING** These products can expose you to chemicals including NICKEL or LEAD, which are known to the state of California to cause cancer, and LEAD which is known to cause birth defects or other reproductive harm. For more information go to [www.P65Warnings.ca.gov](http://www.P65Warnings.ca.gov).



A

B

C

D

E

F

G

H

I

J

K

L

M

N

O

# In-Line Flow Controls



Parker's In-Line flow controls are unidirectional. An arrow on the body indicates the direction of controlled flow. They can be used individually or stacked together using joining clips.

## Product Features:

- Glass reinforced nylon 6.6 body
- Stainless steel gripping ring
- Nickel-plated brass adjustment screw
- Nickel-plated brass locking nut
- Nickel-plated threads
- Nitrile D seal
- Panel mountable

## Markets:

- Factory/Process Automation
- Life Science
- Food Processing
- Water And Beverage
- Petrochemical

## Applications:

- Packaging
- Filling
- Dispensing
- Bottling
- Pneumatic Circuits

## Specifications:

**Pressure Range** 15 to 145 psi (1.0 to 9.9 bar)

**Temperature Range** +32° to +158° F (0 to +70° C)

## Compatible Tubing:

- Semi-rigid nylon
- Polyurethane 95 Durometer Shore A
- Nylon
- Fluoropolymer

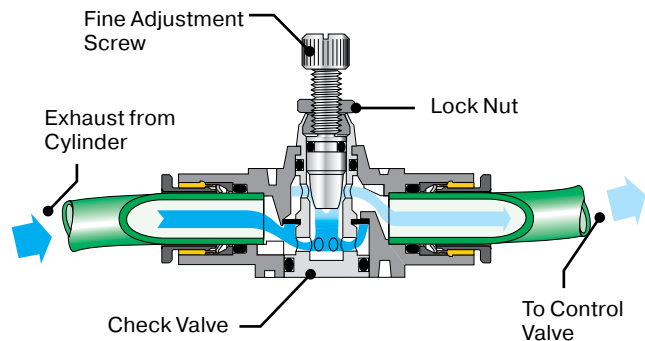

## Assembly Instructions

1. Cut tubing squarely – maximum of 15° angle allowable.
2. Check that port or mating part is clean and free of debris.
3. Mark tubing to appropriate tube insertion length. (see Tube Insertion Chart on page N22)
4. Insert tubing until it bottoms
5. Pull on tubing to verify it is fully inserted
6. To disassemble, simply press release button, hold against body and pull tubing out of fitting.



**WARNING** These products can expose you to chemicals including NICKEL or LEAD, which are known to the state of California to cause cancer, and LEAD which is known to cause birth defects or other reproductive harm. For more information go to [www.P65Warnings.ca.gov](http://www.P65Warnings.ca.gov).



Click here for CADs, Product Specifications or to Configure Parts Online

A

B

C

D

E

F

G

H

I

J

K

L

M

N

O

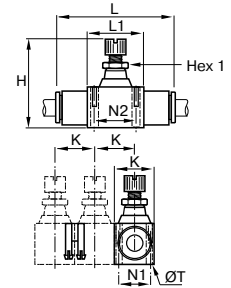

**FC832 In-Line Flow Control**

PART NO.	TUBE SIZE IN	HEX 1 MM	H CLOSED	H OPEN	K	L	L1	N1	N2	T
FC832-4	1/4	8	1.54	1.74	.66	2.00	.90	.43	.66	.12
FC832-6	3/8	14	2.03	2.38	.94	2.87	1.29	.62	1.01	1.60
FC832-8	1/2	14	2.24	2.63	1.09	3.35	1.37	.78	1.07	.16

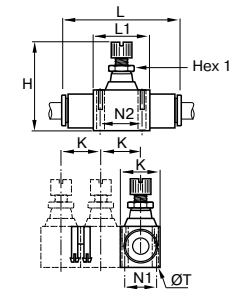

**FCB832 In-Line Bi-directional Flow Control**

PART NO.	TUBE SIZE IN	HEX 1 MM	H CLOSED	H OPEN	K	L	L1	N1	N2	T
FCB832-4	1/4	8	1.54	1.74	.66	2.00	.90	.43	.66	.12

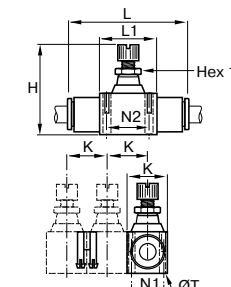

**FC832 In-Line Flow Control**

PART NO.	TUBE SIZE MM	HEX 1	H CLOSED	H OPEN	K	L	L1	N1	N2	T
FC832-4M	4	5	29.5	33.5	12	15	12	8	11	2.2
FC832-6M	6	8	40.5	44.5	17.0	51.0	23.0	11.0	17.0	3.2
FC832-8M (5/16)	8	11	44.0	50.0	18.5	60.5	26.0	12.5	20.0	3.2
FC832-10M	10	14	52.0	61.0	24.0	76.0	33.0	16.0	26.0	4.2
FC832-12M	12	14	57.5	67.5	28.0	86.0	35.0	20.0	27.5	4.2

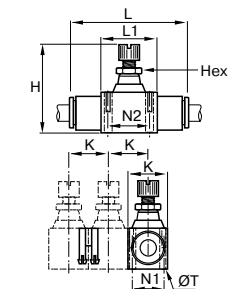

**FCB832 In-Line Bi-directional Flow Control**

PART NO.	TUBE SIZE MM	HEX 1	H CLOSED	H OPEN	K	L	L1	N1	N2	T
FCB832-4M (5/32)	4	5	29.5	33.5	12.0	36.0	15.0	8.0	11.0	2.2
FCB832-6M	6	8	40.0	44.5	17.0	51.0	23.0	11.0	17.0	3.2
FCB832-8M (5/16)	8	11	44.0	50.0	18.5	60.5	26.0	12.5	20.0	3.2

**WARNING** These products can expose you to chemicals including NICKEL or LEAD, which are known to the state of California to cause cancer, and LEAD which is known to cause birth defects or other reproductive harm. For more information go to [www.P65Warnings.ca.gov](http://www.P65Warnings.ca.gov).





Click here for CADs, Product Specifications or to Configure Parts Online

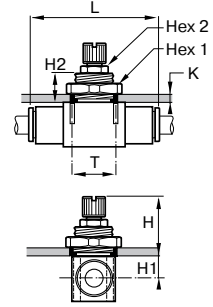

### FCPM832 In-Line Panel Mountable Flow Control

PART NO.	TUBE SIZE MM	HEX 1	HEX 2	H CLOSED	H OPEN	K	L	H1	H2	T
FCPM832-4M	4	14		21.5	25.5	6.0	36.0	6.5	11.0	10.5
FCPM832-6M	6	19		27.5	32.5	7.0	51.0	7.5	13.5	16.5
FCPM832-8M	8	24	11	28.5	34.5	7.0	60.5	9.0	13.5	18.5
FCPM832-10M	10	30	14	29.5	38.5	7.0	76.0	11.5	13.5	24.5
FCPM832-12M	12	32	14	32.0	42.0	8.0	86.0	12.5	15.5	27.5

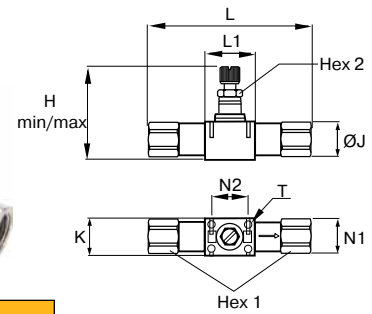

### FC836 Threaded In-Line Flow Control

PART NO.	NPT	HEX 1 MM	HEX 2 MM	H CLOSED	H OPEN	K	L	L1	N1	N2	T
FC836-2	1/8	13	8.00	1.56	1.75	.67	2.70	.91	.43	.67	.12
FC836-4	1/4	16	11.00	1.73	1.97	.73	3.27	1.02	.49	.79	.12
FC836-6	3/8	22	14.00	2.05	2.40	.94	3.82	1.30	.63	1.02	.16
FC836-8	1/2	24	14.00	2.26	2.66	1.10	4.76	1.38	.79	1.08	.16

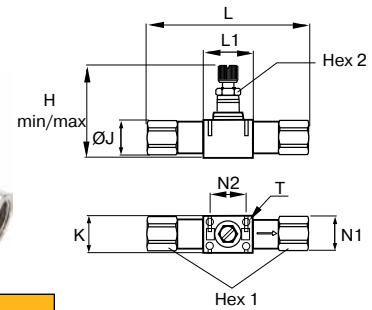

### FC836 Threaded In-Line Flow Control - BSPP

PART NO.	BSPP	HEX 1	HEX 2	H CLOSED	H OPEN	K	L	N1	N2	T
FC836-2G	1/8	13	8	39.5	44.5	17.0	68.5	11.0	17.0	3.2
FC836-4G	1/4	16	11	44.0	50.0	18.5	83.0	12.5	20.0	3.2
FC836-6G	3/8	19	14	52.0	61.0	24.0	97.0	16.0	26.0	4.2
FC836-8G	1/2	24	14	57.5	67.5	28.0	121.0	20.0	27.5	4.2

**WARNING** These products can expose you to chemicals including NICKEL or LEAD, which are known to the state of California to cause cancer, and LEAD which is known to cause birth defects or other reproductive harm. For more information go to [www.P65Warnings.ca.gov](http://www.P65Warnings.ca.gov).



- A
- B
- C
- D
- E
- F
- G
- H
- I
- J
- K
- L
- M
- N
- O

A

B

C

D

E

F

G

H

I

J

K

L

M

N

O



# Metal Flow Controls

Parker's Metal flow controls are suited for use in severe conditions (temperatures, sparks, abrasion, etc.). Adjustment can be made with a screwdriver and locking by use of a wrench.

### Product Features:

- Treated brass body
- Stainless steel gripping ring
- Electroless-nickel-plated brass adjustment screw
- Nickel-plated brass locking nut
- Nickel-plated threads
- Nitrile D seal

### Markets:

- Factory/Process Automation
- Petrochemical
- Automotive Process

### Applications:

- Robotics
- Packaging
- Textile

### Specifications:

**Pressure Range** 15 to 145 psi (1.0 to 9.9 bar)

**Temperature Range** -4° to +158° F (-20° to +70° C)

Note: Temperature rating is based upon filtered, dry compressed air.

### Compatible Tubing:

- Semi-rigid nylon
- Polyurethane 95 Durometer Shore A
- Nylon
- Fluoropolymer

### Meter Out Version

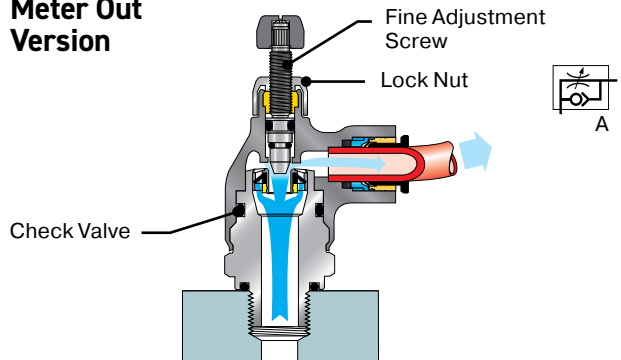

### Meter In Version

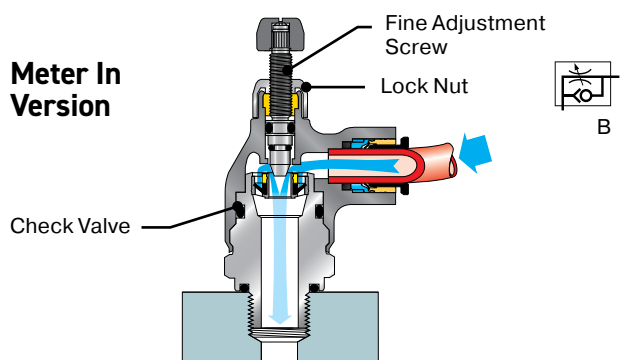

### Assembly Instructions

1. Cut tubing squarely – maximum of 15° angle allowable.
2. Check that port or mating part is clean and free of debris.
3. Mark tubing to appropriate tube insertion length. (see Tube Insertion Chart on page N22)
4. Insert tubing until it bottoms
5. Pull on tubing to verify it is fully inserted
6. To disassemble, simply press release button, hold against body and pull tubing out of fitting.

**WARNING** These products can expose you to chemicals including NICKEL or LEAD, which are known to the state of California to cause cancer, and LEAD which is known to cause birth defects or other reproductive harm. For more information go to [www.P65Warnings.ca.gov](http://www.P65Warnings.ca.gov).



Click here for CADs, Product Specifications or to Configure Parts Online

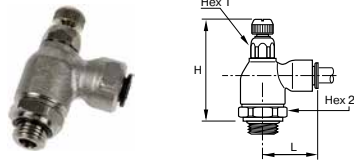

**FC701 Push-to-Connect Meter Out Metal Flow Control - BSPP**

PART NO.	TUBE SIZE MM	BSPP	HEX 1	HEX 2	H CLOSED	H OPEN	L
FC701-4M-2G	4	1/8	10	19	47.0	53.0	21.0
FC701-6M-2G	6	1/8	10	19	47.0	53.0	24.5
FC701-6M-4G	6	1/4	10	19	47.5	53.0	24.5
FC701-8M-2G	8	1/8	14	19	50.0	55.0	29.0
FC701-8M-4G	8	1/4	14	19	50.0	56.0	29.0
FC701-8M-6G	8	3/8	17	25	56.0	62.0	30.5
FC701-10M-4G	10	1/4	14	19	50.0	56.0	35.0
FC701-10M-6G	10	3/8	17	25	56.0	62.0	35.0
FC701-12M-6G	12	3/8	17	25	56.0	62.0	38.0
FC701-12M-8G	12	1/2	17	25	55.0	62.0	38.0
FC701-14M-8G	14	1/2	17	25	55.0	62.0	41.0

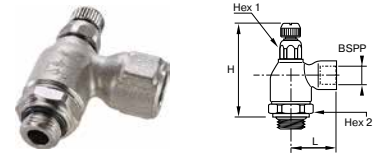

**FC702 Threaded Port Meter Out Metal Flow Control - BSPP**

PART NO.	BSPP	HEX 1	HEX 2	H CLOSED	H OPEN	L
FC702-2G	1/8	10	19	47.0	52.5	22.5
FC702-4G	1/4	14	19	50.5	55.5	32.0
FC702-6G	3/8	17	25	56.0	62.0	34.5
FC702-8G	1/2	17	25	55.0	62.0	37.5

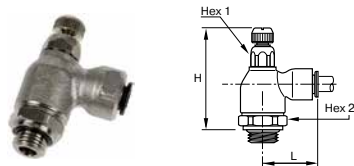

**FCI701 Push-to-Connect Meter In Metal Flow Control - BSPP**

PART NO.	TUBE SIZE MM	BSPP	HEX 1	HEX 2	H CLOSED	H OPEN	L
FCI701-4M-2G	4	1/8	10	19	47.0	53.0	21.0
FCI701-6M-2G	6	1/8	10	19	47.0	53.0	24.5
FCI701-6M-4G	6	1/4	10	19	47.5	53.0	24.5
FCI701-8M-2G	8	1/8	14	19	50.0	55.0	29.0
FCI701-8M-4G	8	1/4	14	19	50.0	56.0	29.0
FCI701-8M-6G	8	3/8	17	25	56.0	62.0	30.5

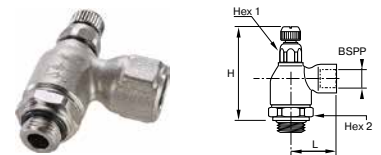

**FCI702 Threaded Port Meter In Metal Flow Control - BSPP**

PART NO.	BSPP	HEX 1	HEX 2	H CLOSED	H OPEN	L
FCI702-2G	1/8	10	19	47.0	52.5	22.5
FCI702-4G	1/4	14	19	50.5	55.5	32.0



**FCK701C Knobless Compression Metal Flow Control - BSPP**

PART NO.	TUBE SIZE MM	BSPP	HEX 1	HEX 2	H	L	L1
FCK701C-4M-2G	4	1/8	13	10	26.0	25.5	14.5
FCK701C-6M-2G	6	1/8	13	13	26.0	25.5	14.5
FCK701C-6M-4G	6	1/4	17	13	31.5	28.5	17.5
FCK701C-8M-2G	8	1/8	13	14	26.0	29.5	15.5
FCK701C-8M-4G	8	1/4	17	14	31.5	31.0	17.0
FCK701C-10M-4G	10	1/4	17	19	31.5	35.0	19.0
FCK701C-10M-6G	10	3/8	20	19	44.5	37.5	19.0
FCK701C-10M-8G	10	1/2	23	19	50.0	37.5	19.0
FCK701C-12M-8G	12	1/2	23	22	50.0	38.0	21.5

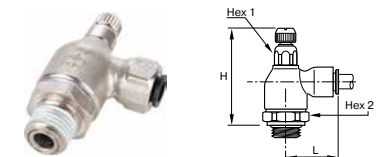

**FC705 Push-to-Connect Meter Out Metal Flow Control**

PART NO.	TUBE SIZE IN	NPT	HEX 1 MM	HEX 2 MM	H CLOSED	H OPEN	L
FC705-4-2	1/4	1/8	19	10	1.79	2.01	0.97
FC705-4-4	1/4	1/4	19	10	1.79	2.01	0.97
FC705-6-4	3/8	1/4	19	14	1.91	2.11	1.14
FC705-6-6	3/8	3/8	25	17	2.15	2.40	1.40

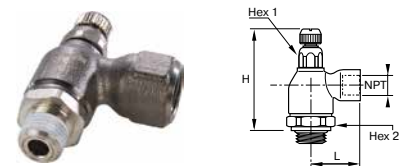

**FC708 Threaded Port Meter Out Flow Control**

PART NO.	NPT	HEX 1 MM	HEX 2 MM	H CLOSED	H OPEN	L
FC708-2	1/8	19	10	1.79	2.01	.89
FC708-4	1/4	19	14	1.91	2.11	1.28
FC708-6	3/8	25	17	2.15	2.40	1.36
FC708-8	1/2	25	17	2.15	2.40	1.50

**WARNING** These products can expose you to chemicals including NICKEL or LEAD, which are known to the state of California to cause cancer, and LEAD which is known to cause birth defects or other reproductive harm. For more information go to [www.P65Warnings.ca.gov](http://www.P65Warnings.ca.gov).



- A
- B
- C
- D
- E
- F
- G
- H
- I
- J
- K
- L
- M
- N
- O

A

B

# Brass Flow Controls

## Specifications:

**Working Pressure** 15 to 150 psi (1.0 to 10.34 bar)

**Working Temperature** 0° to +200° F (-17.8° to +93.3° C)

Note: Temperature rating is based upon filtered, dry compressed air.

## Product Features:

- Controls the speed of a pneumatic actuator
- All brass Construction
- Allen wrench adjusting screw
- NPT and BSPP threads
- Threaded and Push-to-Connect bodies
- UL94 V-0 Flame Resistance Standard
- Silicone Free

**Applications:** Robotic Welding, End-of-Arm Tooling, Factory Automation, Automotive Assembly, Packaging, etc.

**Compatible Tubing:** Polyethylene, 95FR, Polyurethane 95 Durometer Shore A, Semi-rigid Nylon, FEP Fluoropolymer

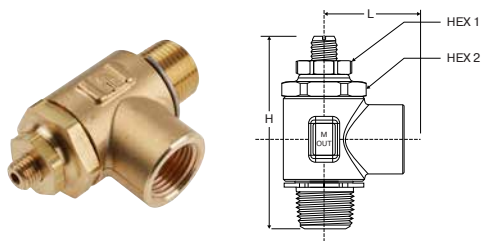
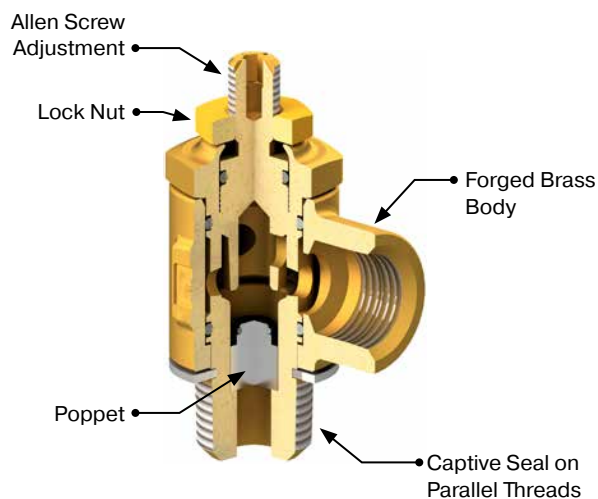

## FC703 Threaded Port Meter Out Metal Flow Control – NPT

PART NO.	NPT	HEX 1	HEX 2	H OPEN	H CLOSED	L
FC703-2	1/8	7/16	5/8	1.84	1.70	.67
FC703-4	1/4	5/8	15/16	2.52	2.34	1.00
FC703-6	3/8	5/8	15/16	2.44	2.29	1.00
FC703-8	1/2	13/16	1 1/8	2.72	2.60	1.31

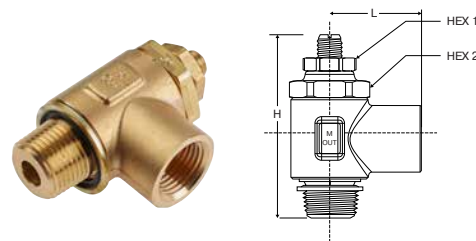

## FC703 Threaded Port Meter Out Metal Flow Control – BSPP

PART NO.	BSPP	HEX 1	HEX 2	H OPEN	H CLOSED	L
FC703-2G	1/8	7/16	5/8	1.84	1.70	.78
FC703-4G	1/4	5/8	15/16	2.52	2.34	1.05
FC703-6G	3/8	5/8	15/16	2.44	2.29	1.20
FC703-8G	1/2	13/16	1 1/8	2.72	2.60	1.55

**WARNING** These products can expose you to chemicals including NICKEL or LEAD, which are known to the state of California to cause cancer, and LEAD which is known to cause birth defects or other reproductive harm. For more information go to [www.P65Warnings.ca.gov](http://www.P65Warnings.ca.gov).



[Click here for CADs, Product Specifications or to Configure Parts Online](#)

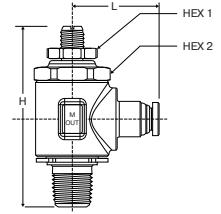
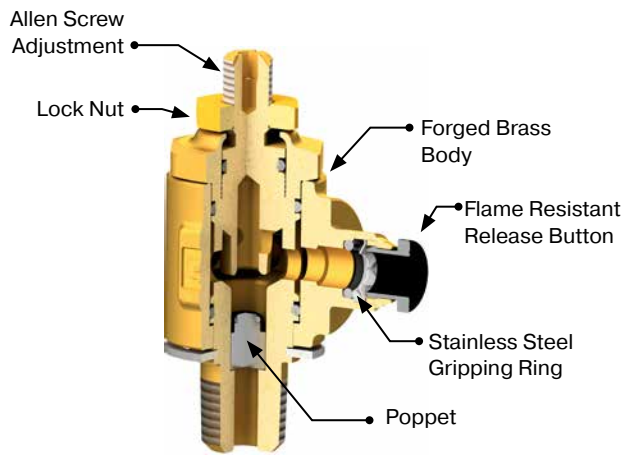

**FC703 Push-To-Connect Meter Out Metal Flow Control – NPT**

PART NO.	TUBE SIZE IN	NPT	HEX 1	HEX 2	H OPEN	H CLOSED	L
FC703-4-2	1/4	1/8	7/16	5/8	1.84	1.70	1.21
FC703-4-4	1/4	1/4	5/8	15/16	2.52	2.34	1.21
FC703-6-4	3/8	1/4	5/8	15/16	2.52	2.34	1.29
FC703-6-6	3/8	3/8	5/8	15/16	2.44	2.29	1.29

- A
- B
- C
- D
- E
- F
- G
- H
- I
- J
- K
- L
- M
- N
- O

**WARNING** These products can expose you to chemicals including NICKEL or LEAD, which are known to the state of California to cause cancer, and LEAD which is known to cause birth defects or other reproductive harm. For more information go to [www.P65Warnings.ca.gov](http://www.P65Warnings.ca.gov).



A

B

C

D

E

F

G

H

I

J

K

L

M

N

O

# Stainless Steel Flow Controls



Parker's Stainless Steel Flow Controls are used to regulate the speed of a cylinder rod as well as flow in environments with high mechanical or chemical constraints.

### Product Features:

- Suitable for corrosive environments
- Excellent mechanical and chemical resistance
- 100% leak tested in production
- Smooth external surfaces to facilitate cleaning
- Suitable for food applications

### Markets:

- Factory/Process Automation
- Life Science
- Food Processing
- Water And Beverage
- Petrochemical

### Applications:

- Packaging
- Filling
- Dispensing
- Bottling,
- Pneumatic Circuits
- Semi-Conductors

### Specifications:

**Pressure Range** 15 to 145 psi (1.0 to 9.9 bar)

**Temperature Range** +32° to +158° F (0 to +70° C)

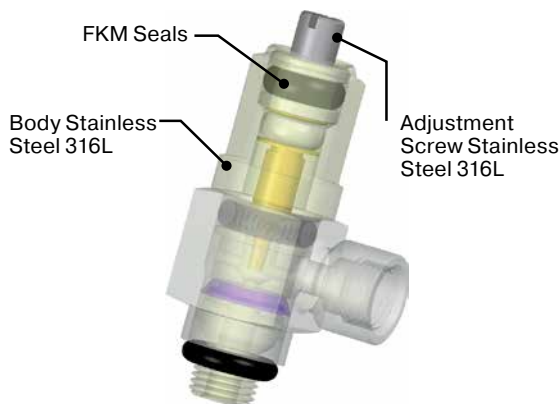

### Assembly Instructions

1. Cut tubing squarely – maximum of 15° angle allowable.
2. Check that port or mating part is clean and free of debris.
3. Mark tubing to appropriate tube insertion length. (see Tube Insertion Chart on page N22)
4. Insert tubing until it bottoms
5. Pull on tubing to verify it is fully inserted
6. To disassemble, simply press release button, hold against body and pull tubing out of fitting.

### Operation

#### Exhaust Model with External Adjustment

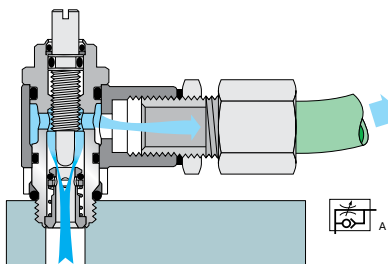

#### Bi-Directional Model with External Adjustment

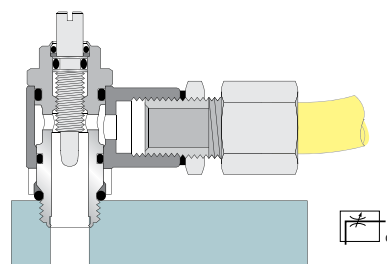

**WARNING** These products can expose you to chemicals including NICKEL or LEAD, which are known to the state of California to cause cancer, and LEAD which is known to cause birth defects or other reproductive harm. For more information go to [www.P65Warnings.ca.gov](http://www.P65Warnings.ca.gov).



[Click here for CADs, Product Specifications or to Configure Parts Online](#)

**7810, 7812, 7815, 7817 Threaded Port Knobless  
Stainless Steel Flow Control - NPT, UNF**

PART NO. METER OUT	PART NO. BI-DIRECTIONAL	C	E	E1	F	H	J	L	WT. OZ.
7810 20 20	7812 20 20	10-32	.16	.16	8	.94	.35	.43	.95
7815 11 11	7817 11 11	1/8	.20	.31	13	1.50	.59	.67	1.23
7815 14 14	7817 14 14	1/4	.31	.47	17	1.38	.71	.94	1.69
7815 18 18	7817 18 18	3/8	.28	.55	20	1.89	.87	1.06	2.08
7815 22 22	7817 22 22	1/2	.31	.59	23	2.52	1.10	1.22	2.68

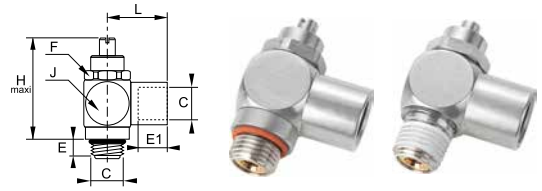

**7810, 7812, Threaded Port Knobless  
Stainless Steel Flow Control - BSPP Metric**

PART NO. METER OUT	PART NO. BI-DIRECTIONAL	C	E	E1	F	H	J	L	WT. KG.
7810 19 19	7812 19 19	M5X0.8	4	4	8	24	10	11	.027
7810 10 10	7812 10 10	G1/8	5	8	13	38	15	17	.035
7810 13 13	7812 13 13	G1/4	8	12	17	40	18	24	.048
7810 17 17	7812 17 17	G3/8	7	12	20	53	22	24	.059
7810 21 21	7812 21 21	G1/2	8	15	23	69	28	31	.076

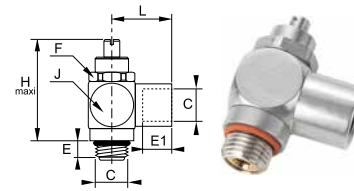

**7835 Push-to-Connect Knobless  
Stainless Steel Flow Control Tube to NPT**

PART NO. METER OUT	ØD	C	F MM	H	J	L	WT. OZ.
7835 56 11	1/4	1/8	13	1.30	.59	.87	1.69
7835 60 18	3/8	3/8	20	1.89	.87	1.26	2.68

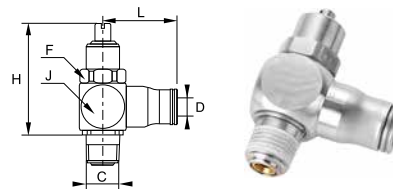

**WARNING** These products can expose you to chemicals including NICKEL or LEAD, which are known to the state of California to cause cancer, and LEAD which is known to cause birth defects or other reproductive harm. For more information go to [www.P65Warnings.ca.gov](http://www.P65Warnings.ca.gov).

- A
- B
- C
- D
- E
- F
- G
- H
- I
- J
- K
- L
- M
- N
- O

A

B

C

D

E

F

G

H

I

J

K

L

M

N

O



# In-Line Check Valves

Parker's In-Line Check Valves allows air to pass in one direction while blocking flow in the other direction. The body of the fitting contains an arrow to indicate the direction of flow.

## Product Features:

- Nylon/Nickel-plated brass body
- VC – Acetal body
- Stainless steel gripping ring
- Nickel-plated brass threads
- Nitrile O-ring
- EPDM O-ring (VC)

## Markets:

- Factory/Process Automation
- Packaging
- Petrochemical
- Pneumatics
- Semi-Conductor

## Applications:

- Robotics
- Packaging
- Textile
- Machine Tools
- Pneumatic Systems
- Vacuum

## Specifications:

**Pressure Range** 15 to 145 psi (1.0 to 9.9 bar)

**Temperature Range** +34° to +150° F (+1.1° to 65.5° C)

**Cracking Pressure** PLCK – 7 PSI (0.4 bar),  
VC – 1/3 PSI (0.02 bar)

## Compatible Tubing:

- Semi-rigid nylon
- Polyurethane 95 Durometer Shore A
- Nylon
- Fluoropolymer

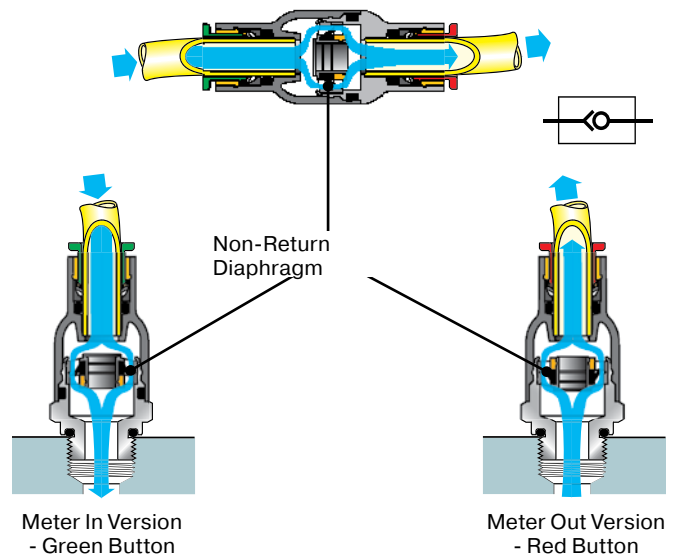

## Assembly Instructions

1. Cut tubing squarely – maximum of 15° angle allowable.
2. Check that port or mating part is clean and free of debris.
3. Mark tubing to appropriate tube insertion length. (see Tube Insertion Chart on page N22)
4. Insert tubing until it bottoms
5. Pull on tubing to verify it is fully inserted
6. To disassemble, simply press release button, hold against body and pull tubing out of fitting.

**WARNING** These products can expose you to chemicals including NICKEL or LEAD, which are known to the state of California to cause cancer, and LEAD which is known to cause birth defects or other reproductive harm. For more information go to [www.P65Warnings.ca.gov](http://www.P65Warnings.ca.gov).





[Click here for CADs, Product Specifications or to Configure Parts Online](#)

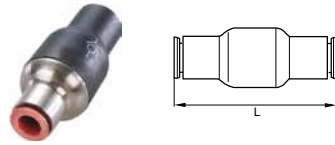

**32PLCK In-Line Check Valve**

PART NO.	TUBE SIZE IN	L
32PLCK-4	1/4	1.61
32PLCK-6	3/8	2.50

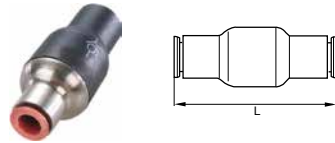

**32PLCK In-Line Check Valve**

PART NO.	TUBE SIZE MM	L
32PLCK-4M (5/32)	4	38.5
32PLCK-6M	6	41.0
32PLCK-8M (5/16)	8	51.5
32PLCK-10M	10	63.5
32PLCK-12M	12	66.5

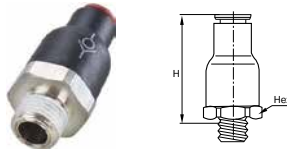

**W68PLCK Male Check Valve**

PART NO.	TUBE SIZE IN	NPT / UNF	HEX MM	H
W68PLCK-4M-2	5/32	1/8	16	1.12
W68PLCK-4-2	1/4	1/8	19	1.42
W68PLCK-4-4	1/4	1/4	19	1.42
W68PLCK-6-4	3/8	1/4	23	1.65
W68PLCK-6-6	3/8	3/8	23	1.65

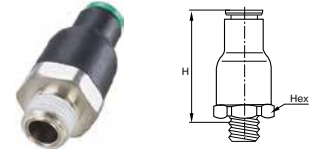

**W68PLCKI Male Check Valve Meter In**

PART NO.	TUBE SIZE IN	NPT / UNF	HEX MM	H
68PLCKI-4M-0	5/32	10-32	9	1.26
W68PLCKI-4M-2	5/32	1/8	16	1.12
W68PLCKI-4-2	1/4	1/8	19	1.42
W68PLCKI-4-4	1/4	1/4	19	1.42
W68PLCKI-6-4	3/8	1/4	23	1.65
W68PLCKI-6-6	3/8	3/8	23	1.65

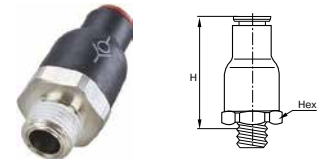

**W68PLCK Male Check Valve Meter Out - BSPT**

PART NO.	TUBE SIZE MM	BSPT	HEX 1	H
W68PLCK-4M-2R	4	1/8	16	28.5
W68PLCK-6M-2R	6	1/8	16	30.5
W68PLCK-6M-4R	6	1/4	16	30.5
W68PLCK-8M-2R	8	1/8	19	36.0
W68PLCK-8M-4R	8	1/4	19	36.0
W68PLCK-12M-6R	12	3/8	23	42.0

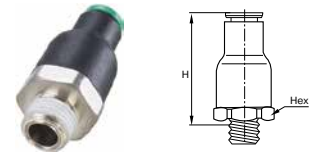

**W68PLCKI Male Check Valve Meter In - BSPT**

PART NO.	TUBE SIZE MM	BSPT	HEX 1	H
W68PLCKI-4M-2R	4	1/8	16	28.5
W68PLCKI-6M-2R	6	1/8	16	30.5
W68PLCKI-6M-4R	6	1/4	16	30.5
W68PLCKI-8M-2R	8	1/8	19	36.0
W68PLCKI-8M-4R	8	1/4	19	36.0

**WARNING** These products can expose you to chemicals including NICKEL or LEAD, which are known to the state of California to cause cancer, and LEAD which is known to cause birth defects or other reproductive harm. For more information go to [www.P65Warnings.ca.gov](http://www.P65Warnings.ca.gov).



Click here for CADs, Product Specifications or to Configure Parts Online

A

B

C

D

E

F

G

H

I

J

K

L

M

N

O

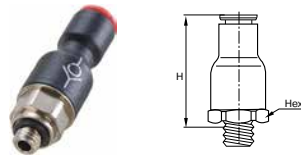

**68PLCK Male Check Valve Meter Out - BSPP**

PART NO.	TUBE SIZE MM	BSPP	HEX 1	H
68PLCK-4M-M5	4	M5X0.8	9	32.0
68PLCK-6M-2G	6	1/8	16	30.5
68PLCK-6M-4G	6	1/4	16	30.5
68PLCK-8M-2G	8	1/8	19	36.0
68PLCK-8M-4G	8	1/4	19	36.0

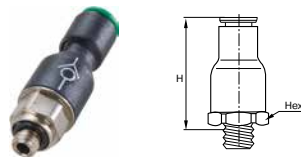

**68PLCKI Male Check Valve Meter In - BSPP**

PART NO.	TUBE SIZE MM	BSPP	HEX 1	H
68PLCKI-6M-2G	6	1/8	16	30.5
68PLCKI-8M-2G	8	1/8	19	36.0
68PLCKI-8M-4G	8	1/4	19	36.0
68PLCKI-12M-6G	12	3/8	23	42.0
68PLCKI-12M-8G	12	1/2	23	44.0

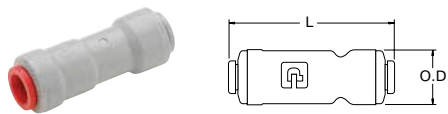

**VC – Check Valve**

PART NO.	TUBE SIZE IN	L	O.D.
A4VC4-MG	1/4	2.00	.66
A5VC5-MG	5/16	2.10	.70
A6VC6-MG	3/8	2.15	.80
A8VC8-MG	1/2	2.68	.91

**WARNING** These products can expose you to chemicals including NICKEL or LEAD, which are known to the state of California to cause cancer, and LEAD which is known to cause birth defects or other reproductive harm. For more information go to [www.P65Warnings.ca.gov](http://www.P65Warnings.ca.gov).



# Stainless Steel Check Valves

Parker's Stainless Steel Check Valves are ideally suited to harsh environments and for conveying industrial fluids. These check valves allow fluids to flow in one direction and prevent them from flowing in the other.

## Product Features:

- 316L Stainless Steel Body & Poppet
- 302 Stainless Steel Spring
- FKM Seals
- Smooth external surfaces contribute to equipment cleanliness
- Suitable for use in corrosive environments

## Markets:

- Factory/Process Automation
- Life Science
- Food Processing
- Water And Beverage
- Petrochemical

## Applications:

- Pneumatics
- Machine Tools
- Processing
- Chemical
- Printing

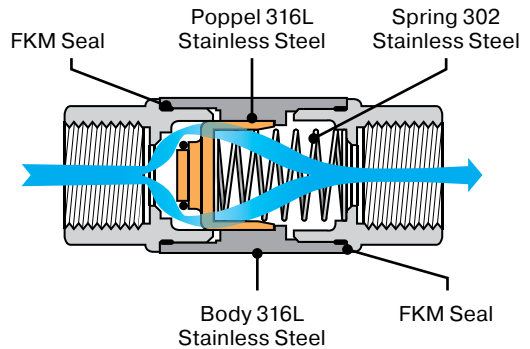

## Specifications:

**Pressure Range** 7 to 580 PSI (0.4 to 39.9 bar)

**Cracking Pressure** 3.6 PSI (0.2 bar)

**Temperature Range** -4° to +356° F (-20° to +180° C)

## Flow Characteristics

MODEL	WATER FLOW AT 90 PSI	KV
1/8	.67 SCFM	1.60
1/4	.70 SCFM	1.69
3/8	1.26 SCFM	3.01
1/2	1.29 SCFM	3.10
3/4	2.33 SCFM	5.59
1	3.27 SCFM	7.86

**WARNING** These products can expose you to chemicals including NICKEL or LEAD, which are known to the state of California to cause cancer, and LEAD which is known to cause birth defects or other reproductive harm. For more information go to [www.P65Warnings.ca.gov](http://www.P65Warnings.ca.gov).



Click here for CADs, Product Specifications or to Configure Parts Online

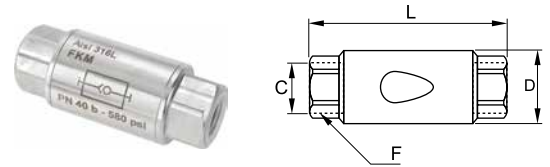
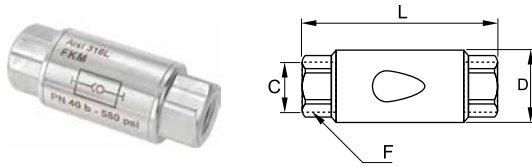

**4890 Unidirectional Female - BSPP**

PART NO.	C	DN	D MM	F MM	L MM	WT. KG.
4890 10 10	G1/8	10	22	17	50	.084
4890 13 13	G1/4	10	22	17	50	.074
4890 17 17	G3/8	15	30	22	67	.182
4890 21 21	G1/2	15	30	25	71	.196
4890 27 27	G3/4	20	42	32	84	.288
4890 34 34	G1	25	42	38	90	.416

**4895 Unidirectional Female - NPT**

PART NO.	C	DN	D MM	F MM	L MM	WT. KG.
4895 11 11	1/8	10	22	18	50	.084
4895 14 14	1/4	10	22	18	54	.080
4895 18 18	3/8	15	30	22	73	.198
4895 22 22	1/2	15	30	25	77	.213

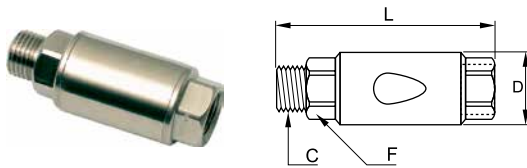

**4891 Unidirectional Male to Female - BSPP**

PART NO.	C	DN	D MM	F MM	L MM	WT. KG.
4891 10 10	G1/8	10	22	17	56	.086
4891 13 13	G1/4	10	22	17	58	.082
4891 17 17	G3/8	15	30	22	75	.190
4891 21 21	G1/2	15	30	25	79	.280
4891 27 27	G3/4	20	42	32	98	.302
4891 34 34	G1	25	42	38	104	.424

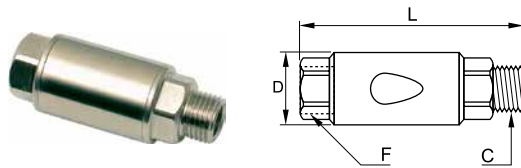

**4892 Unidirectional Female to Male - BSPP**

PART NO.	C	DN	D MM	F MM	L MM	WT. KG.
4892 10 10	G1/8	10	22	17	56	.086
4892 13 13	G1/4	10	22	17	58	.082
4892 17 17	G3/8	15	30	22	75	.190
4892 21 21	G1/2	15	30	25	79	.280
4892 27 27	G3/4	20	42	32	98	.302
4892 34 34	G1	25	42	38	104	.424

**WARNING** These products can expose you to chemicals including NICKEL or LEAD, which are known to the state of California to cause cancer, and LEAD which is known to cause birth defects or other reproductive harm. For more information go to [www.P65Warnings.ca.gov](http://www.P65Warnings.ca.gov).



A

B

C

D

E

F

G

H

I

J

K

L

M

N

O



# Piloted Operated Check Valves

Parker's Piloted Operated Check Valves are designed to protect installations. If the compressed air supply is removed they lock the air supply to the cylinder, maintaining it in position.

## Product Features:

- Orientable and adjustable through 3 axis
- Can be integrated into any installation configuration
- Vent saves time on restart after maintenance operations
- Multi-purpose fitting
  - Piloted non-return valve
  - Flow control regulator
  - Manual exhaust

## Markets:

- Factory/Process Automation
- Food Processing
- Pneumatics
- Automotive

## Applications:

- Pneumatics
- Machine Tools
- Processing
- Packaging
- Assembly

## Specifications:

**Pressure Range** 14 to 145 PSI (0.9 to 9.9 bar)

**Cracking Pressure** 4.3 PSI (0.2 bar)

**Temperature Range** +23° to +140° F (-5° to 60° C)

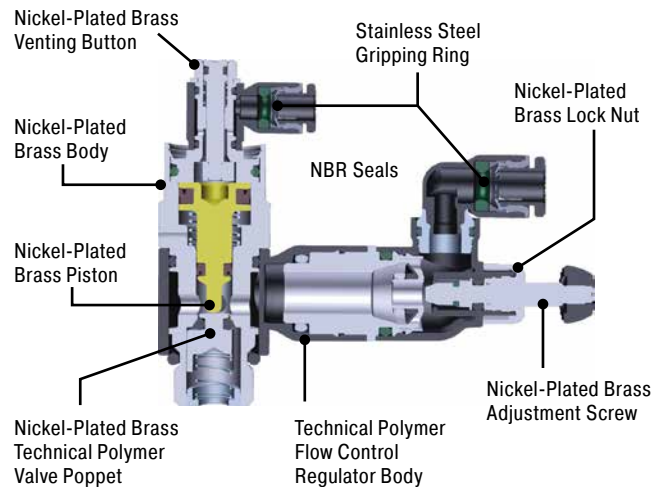

## Assembly Instructions

1. Cut tubing squarely – maximum of 15° angle allowable.
2. Check that port or mating part is clean and free of debris.
3. Mark tubing to appropriate tube insertion length. (see Tube Insertion Chart on page N22)
4. Insert tubing until it bottoms
5. Pull on tubing to verify it is fully inserted
6. To disassemble, simply press release button, hold against body and pull tubing out of fitting.

**WARNING** These products can expose you to chemicals including NICKEL or LEAD, which are known to the state of California to cause cancer, and LEAD which is known to cause birth defects or other reproductive harm. For more information go to [www.P65Warnings.ca.gov](http://www.P65Warnings.ca.gov).



Click here for CADs, Product Specifications or to Configure Parts Online

- A
- B
- C
- D
- E
- F
- G
- H
- I
- J
- K
- L
- M
- N
- O

## Operation

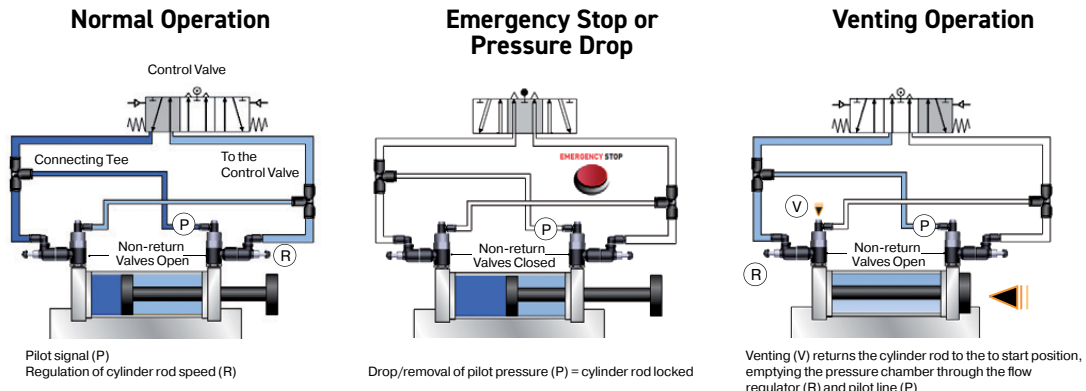

### 7892 Piloted Non-Return Valve - BSPP

PART NO.	D MM	C	E MM	F MM	G MM	H MM	H1 MM	H2 MM	L MM	WT. KG.
7892 06 10	6	G1/8	6	13	14	42	30	7	21	.028
7892 06 13	6	G1/4	9	17	18.5	45	32	9	23	.049
7892 08 10	8	G1/8	6	13	14	42	29	9	25	.029
7892 08 13	8	G1/4	9	17	18.5	45	32	9	27	.051
7892 08 17	8	G3/8	6	20	22.5	57	41	11	28	.093
7892 10 17	10	G3/8	6	20	22.5	57	41	11	31	.094
7892 10 21	10	G1/2	10	24	28	63	47	16	36	.172
7892 12 21	12	G1/2	10	24	28	63	47	16	36	.162

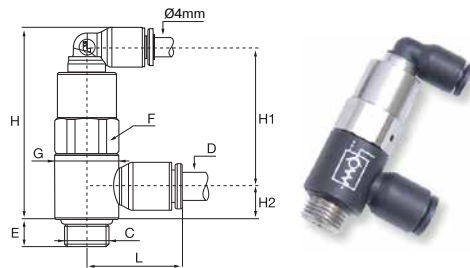

### 7894 Piloted Non-Return Valve with Flow Regulator and Exhaust - BSPP

PART NO.	D MM	C	E MM	F1 MM	F2 MM	G MM	H MM	H1 MM	H2 MM	H3 MM	L MIN	L MAX	L MM	WT. KG.
7894 06 10	6	G1/8	6	13	8	14	46	7	24	31	48.5	51	16	.049
7894 06 13	6	G1/4	9	17	10	18.5	49	11	18	31	59.5	65	17	.081
7894 08 10	8	G1/8	6	13	8	14	46	7	27	31	48.5	51	22	.050
7894 08 13	8	G1/4	9	17	10	18.5	49	11	23	31	59.5	65	23	.084
7894 08 17	8	G3/8	6	20	14	22.5	69	13	21	40	67.5	73	23	.148
7894 10 17	10	G3/8	6	20	14	22.5	69	13	29	40	67.5	73	26	.152
7894 10 21	10	G1/2	10	24	17	28	76	12.5	26	47	74	81	26	.234
7894 12 21	12	G1/2	10	24	17	28	76	12.5	27	47	74	81	30	.236

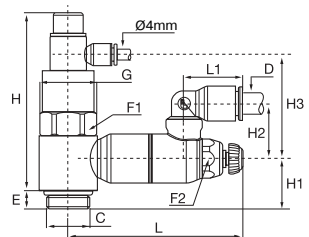

**WARNING** These products can expose you to chemicals including NICKEL or LEAD, which are known to the state of California to cause cancer, and LEAD which is known to cause birth defects or other reproductive harm. For more information go to [www.P65Warnings.ca.gov](http://www.P65Warnings.ca.gov).

A

B

C

D

E

F

G

H

I

J

K

L

M

N

O



# Pneumatic Slide Valves

Parker's Slide Valves may be used to effect an immediate isolation of the air line by venting the system to atmosphere. By moving the sleeve in one direction, the air is free to pass through the slide valve to the system. By moving it in the opposite direction, the supply is shut off and the downstream air is allowed to exhaust to the atmosphere.

## Product Features:

- Lightweight due to use of aluminum
- Nitrile Seals
- Immediate identification of the venting system by the color (red)
- Uni-directional use ensures the downstream circuit is vented
- Operated in the plane of the tube

## Markets:

- Factory/Process Automation
- Food Processing
- Packaging

## Applications:

- Pneumatics
- Conveyors
- Packaging
- Textile
- Plastics Engineering

## Specifications:

**Pressure Range** Up to 230 PSI (15.8 bar)

**Temperature Range** +15° to +175° F (-9.4° to +79.4° C)

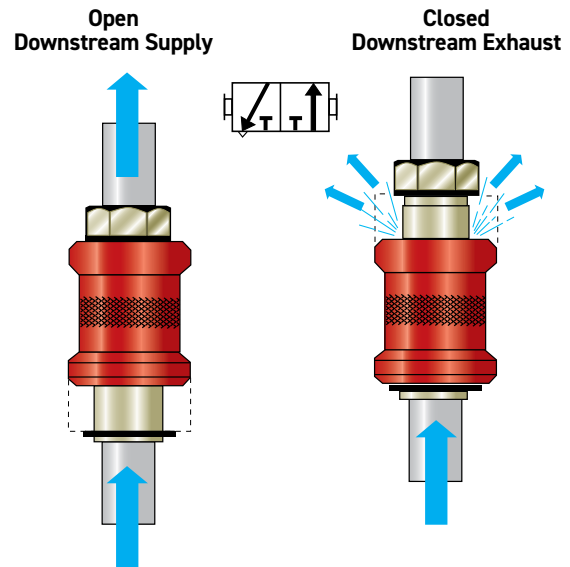

**WARNING** These products can expose you to chemicals including NICKEL or LEAD, which are known to the state of California to cause cancer, and LEAD which is known to cause birth defects or other reproductive harm. For more information go to [www.P65Warnings.ca.gov](http://www.P65Warnings.ca.gov).



Click here for CADs, Product Specifications or to Configure Parts Online

- A
- B
- C
- D
- E
- F
- G
- H
- I
- J
- K
- L
- M
- N
- O

### 0660 Female Slide Valve - NPT

PART NO.	C	DN	F	G	L	WT. OZ.
0660 04 11	1/8	.16	.55	.98	1.89	2.12
0660 07 14	1/4	.27	.67	1.18	2.28	3.71
0660 10 18	3/8	.39	.87	1.38	2.68	6.18
0660 14 22	1/2	.55	1.06	1.57	3.15	9.53

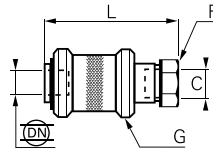

### 0661 Male to Female Slide Valve - NPT

PART NO.	C	DN	F	G	L	WT. OZ.
0661 04 11	1/8	.16	.55	.98	2.19	2.47
0661 07 14	1/4	.27	.67	1.18	2.75	4.59
0661 10 18	3/8	.39	.87	1.38	3.21	7.59
0661 14 22	1/2	.55	1.06	1.57	3.75	11.30

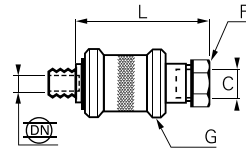

### 0669 Female Slide Valve - BSPP

PART NO.	C	DN	F MM	G MM	L MM	WT. KG.
0669 02 19	M5X0.8	2	10	14	30.5	.045
0669 04 10	G1/8	4	14	25	48	.051
0669 07 13	G1/4	7	19	30	58	.084
0669 10 17	G3/8	10	22	35	68	.153
0669 14 21	G1/2	14	27	40	80	.227
0669 19 27	G3/4	19	32	50	83	.242

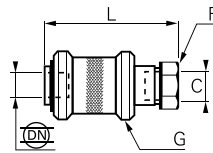

**WARNING** These products can expose you to chemicals including NICKEL or LEAD, which are known to the state of California to cause cancer, and LEAD which is known to cause birth defects or other reproductive harm. For more information go to [www.P65Warnings.ca.gov](http://www.P65Warnings.ca.gov).





# Quick Exhaust Valve



Parker's Quick Exhaust Valve increases the return speed of the cylinder rod by allowing the exhaust to pass directly to atmosphere.

## Product Features:

- Nickel plated brass body
- Nylon seal
- Polyurethane piston
- Reduction in cycle times: return speed improved
- Excellent exhaust capacity
- Ideal for applications in restrictive environments

## Markets:

- Factory/Process Automation
- Packaging
- Industrial
- Pulp & Paper

## Applications:

- Pneumatics
- Conveyors
- Packaging
- Textile
- Plastics Engineering

## Specifications:

**Pressure Range** 10 to 150 PSI (0.6 to 10.3 bar)

**Temperature Range** 0° to +160° F (-17.7 to +71.1° C)

## 7970 Quick Exhaust Valve Threaded Ports - BSPP

PART NO.	C	F	H	H1	L	WT.OZ.
7970 19 19	M5 x 0.8	10	24.8	15.6	4	.029
7970 10 10	G1/8	14	42	28	8	.084
7970 13 13	G1/4	19	53	34.5	11	.148
7970 17 17	G3/8	21	58	36	12	.153
7970 21 21	G1/2	26	71	44	14	.316
7970 27 27	G3/4	32	86	52	18	.449
7970 34 34	G1	38	94	56	19	.531

## 7982 Quick Exhaust Valve Threaded Ports - NPT

PART NO.	C	F	H	H1	L	WT. OZ.
7982 11 11	1/8	14	1.69	1.10	.28	2.97
7982 14 14	1/4	19	2.11	1.38	.37	5.18
7982 18 18	3/8	20	2.19	1.42	.35	5.64
7982 22 22	1/2	26	2.83	1.77	.55	11.29

## Operation:

### Mounted on Cylinder

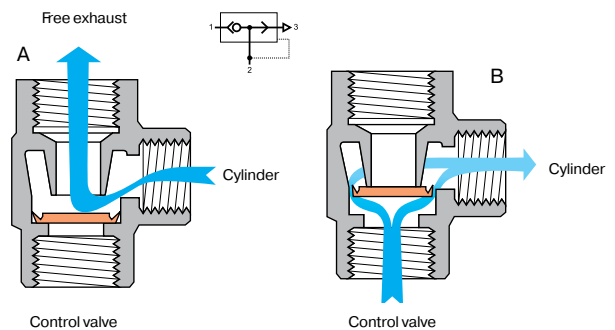

## Installation Diagram

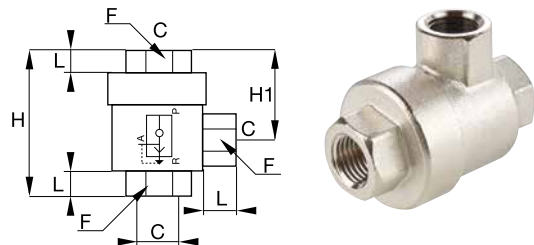
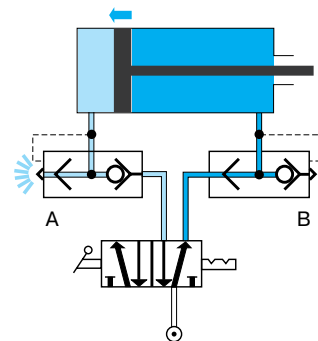

**WARNING** These products can expose you to chemicals including NICKEL or LEAD, which are known to the state of California to cause cancer, and LEAD which is known to cause birth defects or other reproductive harm. For more information go to [www.P65Warnings.ca.gov](http://www.P65Warnings.ca.gov).

- A
- B
- C
- D
- E
- F
- G
- H
- I
- J
- K
- L
- M
- N
- O

A

B

C

D

E

F

G

H

I

J

K

L

M

N

O

# Blocking Valves



Parker's Blocking Valves prevents damage to work and equipment in the event of a loss of pressure. Blocking valves which are mounted in pairs on a cylinder lock the piston by simultaneously cutting off the supply and exhaust.

## Product Features:

- Treated brass body
- Stainless steel gripping ring
- Nickel-plated brass threads
- NBR seals
- Silicone free

## Markets:

- Factory/Process Automation
- Packaging
- Petrochemical
- Automotive Process

## Applications:

- Robotics
- Packaging
- Textile
- Machine Tools

## Compatible Tubing:

- Semi-rigid nylon
- Polyurethane 95 Durometer Shore A
- Nylon
- Fluoropolymer

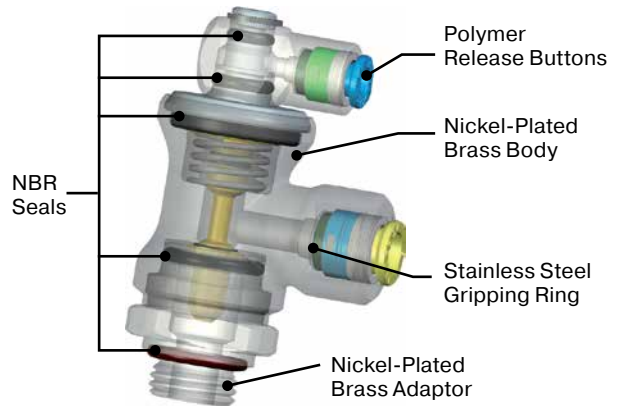

## Specifications:

**Pressure Range** 15 to 145 PSI (1.0 to 9.9 bar)

**Temperature Range** -4° to +160° F (-20° to +71.1° C)

**Leak Rate** <3.2CCM

**Number of Cycles** >10 Million at 68°F and 1 HZ

## Assembly Instructions

1. Cut tubing squarely – maximum of 15° angle allowable.
2. Check that port or mating part is clean and free of debris.
3. Mark tubing to appropriate tube insertion length. (see Tube Insertion Chart on page N22)
4. Insert tubing until it bottoms
5. Pull on tubing to verify it is fully inserted
6. To disassemble, simply press release button, hold against body and pull tubing out of fitting.

## Operation

Cylinder in Operation  
(pilot signal active)

Cylinder Blocked  
(pilot signal removed)

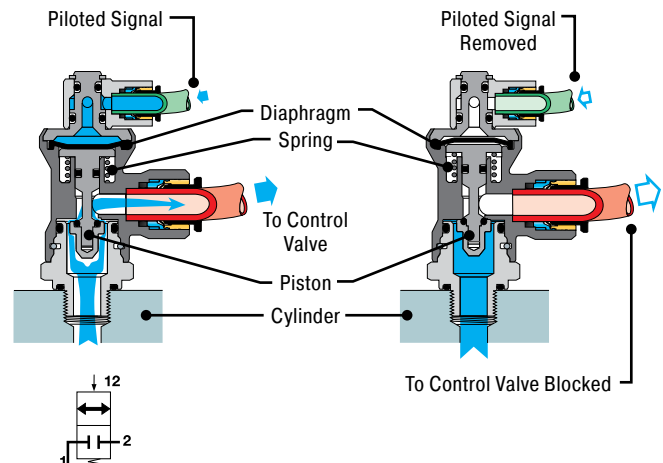

**WARNING** These products can expose you to chemicals including NICKEL or LEAD, which are known to the state of California to cause cancer, and LEAD which is known to cause birth defects or other reproductive harm. For more information go to [www.P65Warnings.ca.gov](http://www.P65Warnings.ca.gov).



Click here for CADs, Product Specifications or to Configure Parts Online

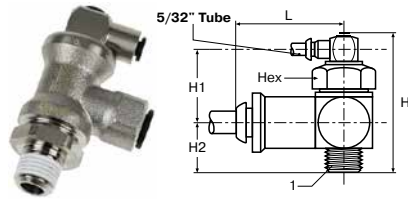

**FC601 Push-to-Connect Lock Out Valves**

PART NO.	TUBE SIZE IN	NPT	HEX MM	H	H1	H2	L
FC601-4-2	1/4	1/8	21	2.03	1.24	.79	1.10
FC601-4-4	1/4	1/4	21	2.03	1.24	.79	1.10
FC601-6-6	3/8	3/8	24	2.19	1.14	1.04	1.38
FC601-8-8	1/2	1/2	24	2.19	1.14	1.04	1.69

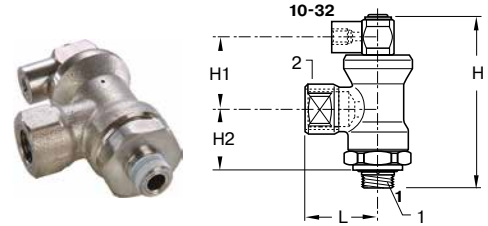

**FC602 Threaded Port Lock Out Valves**

PART NO.	1 NPT	2 NPT	HEX MM	H	H1	H2	L
FC602-2	1/8	1/8	21	2.03	1.24	.79	1.04
FC602-4	1/4	1/4	21	2.03	1.24	.79	1.04
FC602-6	3/8	3/8	24	2.19	1.14	1.04	1.34
FC602-8	1/2	1/2	24	2.19	1.14	1.04	1.57

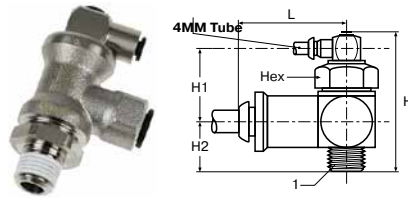

**FC601 Push-to-Connect Lock-Out Valve - BSPT**

PART NO.	TUBE SIZE MM	BSPT	HEX	H	H1	H2	L
FC601-6M-2R	6	1/8	21	53	24.5	21.0	28.0
FC601-6M-4R	6	1/4	21	53	24.5	21.0	28.0
FC601-8M-4R	8	1/4	21	53	24.5	21.0	28.0
FC601-8M-6R	8	3/8	24	56	25.0	23.0	34.5
FC601-10M-6R	10	3/8	24	56	25.0	23.0	35.0
FC601-12M-8R	12	1/2	24	56	25.0	23.0	37.5

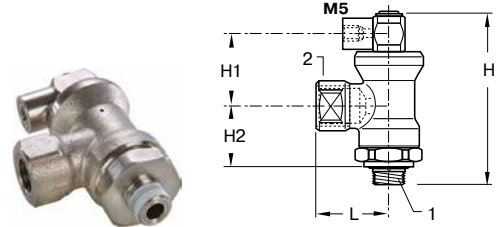

**FC608 Threaded Port Lock-Out Valve - BSPT**

PART NO.	BSPT 1	BSPT 2	HEX	H	H1	H2	L
FC608-4R-2R	1/8	1/4	21	51.5	31.5	20.0	26.5
FC608-4R-4R	1/4	1/4	21	51.5	31.5	20.0	26.5
FC608-6R-6R	3/8	3/8	24	55.5	29.0	26.5	34.0
FC608-8R-8R	1/2	1/2	24	55.5	29.0	26.5	40.0

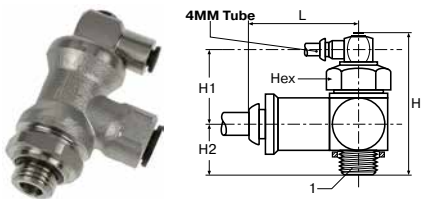

**FC601 Push-to-Connect Lock-Out Valve - BSPP**

PART NO.	TUBE SIZE MM	BSPP	HEX	H	H1	H2	L
FC601-6M-2G	6	1/8	21	53	24.5	21.0	28.0
FC601-6M-4G	6	1/4	21	53	24.5	21.0	28.0
FC601-8M-4G	8	1/4	21	53	24.5	21.0	28.0
FC601-8M-6G	8	3/8	24	56	25.0	23.0	34.5
FC601-10M-6G	10	3/8	24	56	25.0	23.0	35.0
FC601-12M-8G	12	1/2	24	56	25.0	23.0	37.5

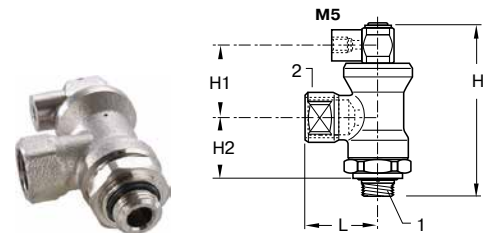

**FC608 Threaded Port Lock-Out Valve - BSPP**

PART NO.	BSPP 1	BSPP 2	HEX	H	H1	H2	L
FC608-4G-2G	1/8	1/4	21	53	24.5	21.0	28.0
FC608-4G-4G	1/4	1/4	21	53	24.5	21.0	28.0
FC608-6G-6G	3/8	3/8	24	56	25.0	23.0	34.0
FC608-8G-8G	1/2	1/2	24	56	25.0	23.0	41.0

**WARNING** These products can expose you to chemicals including NICKEL or LEAD, which are known to the state of California to cause cancer, and LEAD which is known to cause birth defects or other reproductive harm. For more information go to [www.P65Warnings.ca.gov](http://www.P65Warnings.ca.gov).



A

B

C

D

E

F

G

H

I

J

K

L

M

N

O



# Manually-Operated Valves

Parker Legris' manually-operated valves offer a reliable and durable system for opening and closing the circuit when the system has to be switched frequently. They provide a significant reduction in the time needed to work on pneumatic circuits.

## Product Features:

### Manual Switch-Operated Valves

- Downstream control supply provided by simply moving the lever
- 2 models available to provide the best solution for the system:
  - 3/2: opening, closing, venting
- Compact and ergonomic (can be positioned through 360°)
- Silicone-Free

### Markets:

- Factory/Process Automation
- Packaging
- Industrial
- Pulp & Paper

### Applications:

- Robotics
- Conveyors
- Textile
- Plastics Engineering
- Printing
- Pneumatics
- Packaging

## Specifications:

<b>Compatible Fluids</b>	Compressed air
<b>Working Pressure</b>	230 psi (15.8 bar)
<b>Working Temperature</b>	15° to 175° F (-10° to 80° C)

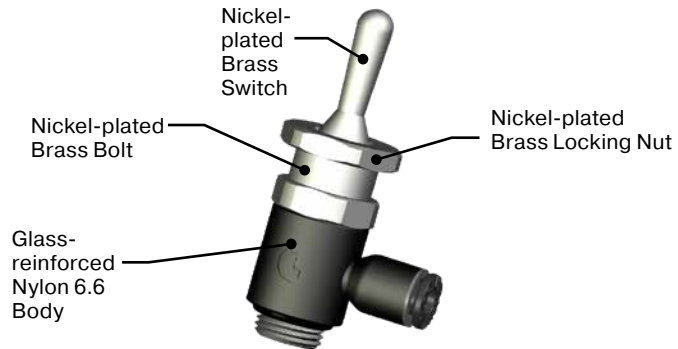

## Operation

### Switch-Operated Valves

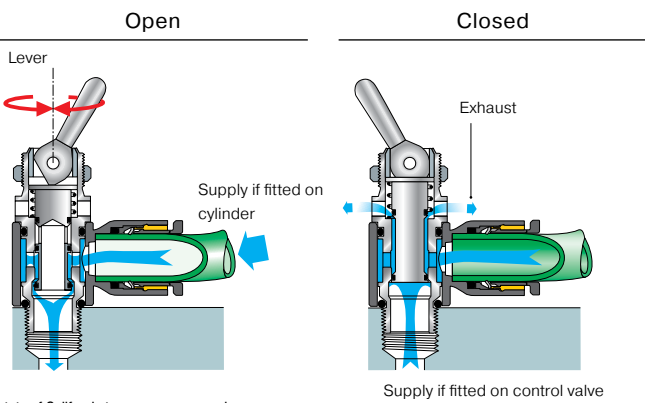
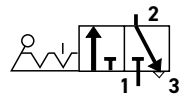

**WARNING** These products can expose you to chemicals including NICKEL or LEAD, which are known to the state of California to cause cancer, and LEAD which is known to cause birth defects or other reproductive harm. For more information go to [www.P65Warnings.ca.gov](http://www.P65Warnings.ca.gov).

Click here for CADs, Product Specifications or to Configure Parts Online

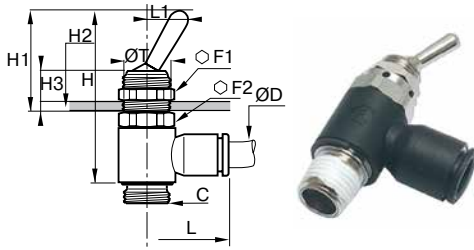

**7805/7806 Manually Operated 3-Way Venting Valve Fractional Inch Tube to NPT**

PART NO. SUPPLY (1)	ØD IN	C NPT	F1 MM	F2 MM	H IN	H1 IN	H2 IN	H3 IN	L IN	L1 IN	ØT IN	W OZ
7805 04 11	5/32	1/8	14	14	1.69	.98	.18	.30	.75	.43	.49	.95
7805 56 11	1/4	1/8	14	14	1.69	.98	.18	.30	.85	.43	.49	1.02
7805 56 14	1/4	1/4	14	17	1.99	.98	.18	.30	.89	.43	.49	1.55
7805 60 14	3/8	1/4	14	17	1.99	.98	.18	.30	1.14	.43	.49	1.69

PART NO. SUPPLY (2)	ØD IN	C NPT	F1 MM	F2 MM	H IN	H1 IN	H2 IN	H3 IN	L IN	L1 IN	ØT IN	W OZ
7806 04 11	5/32	1/8	14	14	1.69	.98	.18	.30	.75	.43	.49	.95
7806 56 11	1/4	1/8	14	14	1.69	.98	.18	.30	.85	.43	.49	1.02
7806 56 14	1/4	1/4	14	17	1.99	.98	.18	.30	.89	.43	.49	1.55
7806 60 14	3/8	1/4	14	17	1.99	.98	.18	.30	1.14	.43	.49	1.69

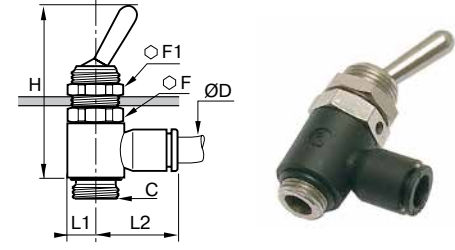

**7800/7801 Manually Operated 3-Way Venting Valve Metric Tube to BSPP or Metric**

PART NO. SUPPLY (1)	ØD MM	C BSPP	F MM	F1 MM	H MM	L1 MM	L2 MM	W KG
7800 04 19	4	M5X0.8	8	-	32	5	16	.020
7800 04 10	4	G1/8	14	14	42.5	7	18.5	.027
7800 06 19	6	M5X0.8	8	-	32	5	19	.022
7800 06 10	6	G1/8	14	14	42.5	7	20	.029
7800 06 13	6	G1/4	17	17	51	9	22	.044
7800 08 10	8	G1/8	14	14	42.5	7	25	.030
7800 08 13	8	G1/4	17	17	51	9	27	.045

PART NO. SUPPLY (2)	ØD MM	C BSPP	F MM	F1 MM	H MM	L1 MM	L2 MM	W KG
7801 04 19	4	M5X0.8	8	-	32	5	16	.020
7801 04 10	4	G1/8	14	14	42.5	7	18.5	.027
7801 06 19	6	M5X0.8	8	-	32	5	19	.022
7801 06 10	6	G1/8	14	14	42.5	7	20	.029
7801 06 13	6	G1/4	17	17	51	9	22	.044
7801 08 10	8	G1/8	14	14	42.5	7	25	.030

**WARNING** These products can expose you to chemicals including NICKEL or LEAD, which are known to the state of California to cause cancer, and LEAD which is known to cause birth defects or other reproductive harm. For more information go to [www.P65Warnings.ca.gov](http://www.P65Warnings.ca.gov).



A

B

C

D

E

F

G

H

I

J

K

L

M

N

O



# Threshold Sensor Fittings

Parker's Threshold Sensor Fitting detects the pressure drop when a cylinder reaches the end of its stroke. They produce a pneumatic or electrical output signal when the pressure drop in the exhaust chamber of the cylinder goes below their back pressure threshold.

## Product Features:

- Polymer body
- Brass screw
- NBR seal

## Markets:

- Factory/Process Automation
- Packaging
- Pneumatics
- Semi-Conductor

## Applications:

- Robotics
- Packaging
- Textile
- Machine Tools
- Pneumatic Systems

## Specifications:

### Model PSBJ,PSPJ

**Pressure Range** 45 to 115 PSI (3.1 to 7.9 bar)

**Temperature Range** +5° to +140° F (-15° to +60° C)

**Breaking Pressure** 8.5 PSI (0.5 bar)

**Response Time** 3 MS

### Model PSPE

**Pressure Range** 45 to 115 PSI (3.1 to 7.9 bar)

**Breaking Pressure** 8.5 PSI (0.5 bar)

**Current Rating** 5A/250VAC – 5W/48VDC

## Compatible Tubing:

- Semi-rigid nylon
- Polyurethane 95 Durometer Shore A
- Nylon
- Fluoropolymer

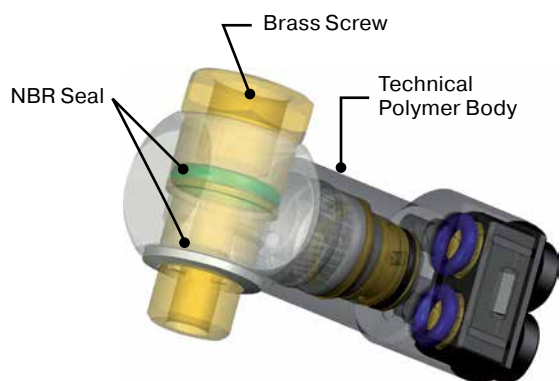

## Operation

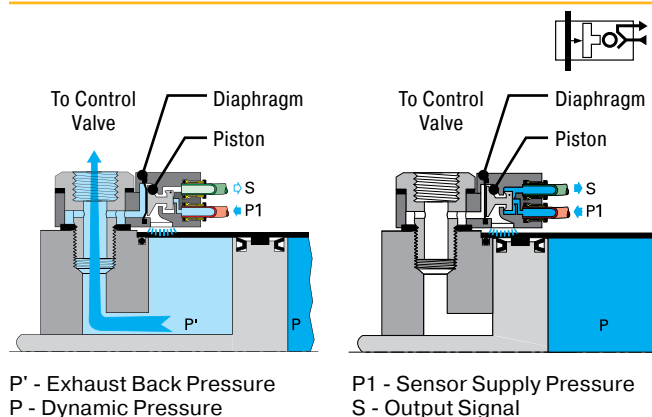

**WARNING** These products can expose you to chemicals including NICKEL or LEAD, which are known to the state of California to cause cancer, and LEAD which is known to cause birth defects or other reproductive harm. For more information go to [www.P65Warnings.ca.gov](http://www.P65Warnings.ca.gov).



Click here for CADs, Product Specifications or to Configure Parts Online

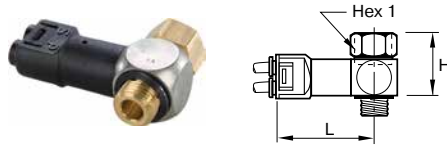

**PSBJ731 Pneumatic Threshold Sensor - 5/32 Pilot**

PART NO.	NPT / UNF	HEX MM	H	L
PSBJ731-0	10-32	5/16	.62	1.70
PSBJ731-2	1/8	9/16	.90	1.74
PSBJ731-4	1/4	5/8	1.09	1.81
PSBJ731-6	3/8	7/8	1.13	1.91
PSBJ731-8	1/2	1	1.17	2.05

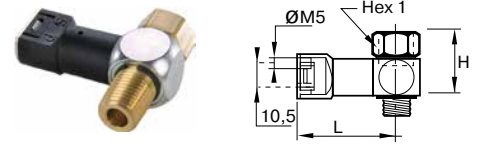

**PSBJ708 Pneumatic Threshold Sensor - M5 Pilot**

PART NO.	BSPP	HEX 1	H	L
PSBJ708-2G	1/8	14	23	40.5
PSBJ708-4G	1/4	17	28	42.5

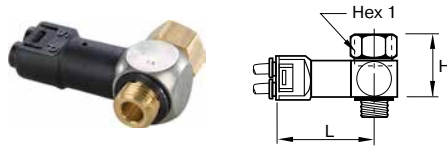

**PSBJ731 Pneumatic Threshold Sensor - 4mm Pilot**

PART NO.	BSPP	HEX 1	H	L
PSBJ731-M5	M5X0.8	8	16	43.5
PSBJ731-2G	1/8	14	23	44.5
PSBJ731-4G	1/4	17	28	46.5
PSBJ731-6G	3/8	22	29	49.0
PSBJ731-8G	1/2	27	30	52.5

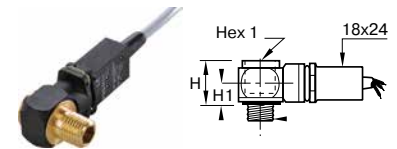

**PSPE731 Pneumatic / Electric Threshold Sensor - BSPP**

PART NO.	BSPP	HEX 1	H	H1	L
PSPE731-M5	M5X0.8	8	20	10	49
PSPE731-2G	1/8	6	20	10	52
PSPE731-4G	1/4	8	20	10	54
PSPE731-6G	3/8	10	22	12	57

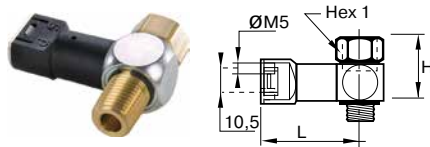

**PSPJ731 Pneumatic Threshold Sensor - 10-32 Pilot**

PART NO.	NPT	HEX 1 MM	H	L
PSPJ731-2	1/8	9/16	.90	1.58
PSPJ731-4	1/4	5/8	1.09	1.66
PSPJ731-6	3/8	7/8	1.13	1.76

**WARNING** These products can expose you to chemicals including NICKEL or LEAD, which are known to the state of California to cause cancer, and LEAD which is known to cause birth defects or other reproductive harm. For more information go to [www.P65Warnings.ca.gov](http://www.P65Warnings.ca.gov).



A

B

C

D

E

F

G

H

I

J

K

L

M

N

O



# Mini Ball Valves

Parker's Mini Ball Valves enable in-line opening and closing of a pneumatic circuit. Handles are color coded and marked with the corresponding pneumatic symbol, in order to enable immediate identification by the user.

## Product Features:

- Nylon body
- Brass stem
- Stainless steel gripping ring
- NBR stem seal
- NBR o-ring
- Nylon Handle
- Lightweight and compact

## Markets:

- Factory/Process Automation
- Packaging
- Petrochemical
- Pneumatics
- Semi-Conductor

## Applications:

- Robotics
- Packaging
- Textile
- Machine Tools
- Pneumatic Systems
- Vacuum

## Specifications:

**Pressure Range** 145 PSI (9.9 bar)

**Temperature Range** -4° to 175° F (-20° to +79.4° C)

**Vacuum Capability** 28" Hg

## Compatible Tubing:

- Semi-rigid nylon
- Polyurethane 95 Durometer Shore A
- Nylon
- Fluoropolymer

## Operation

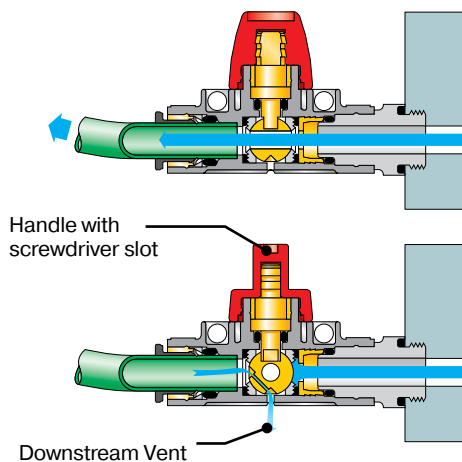

**WARNING** These products can expose you to chemicals including NICKEL or LEAD, which are known to the state of California to cause cancer, and LEAD which is known to cause birth defects or other reproductive harm. For more information go to [www.P65Warnings.ca.gov](http://www.P65Warnings.ca.gov).





[Click here for CADs, Product Specifications or to Configure Parts Online](#)

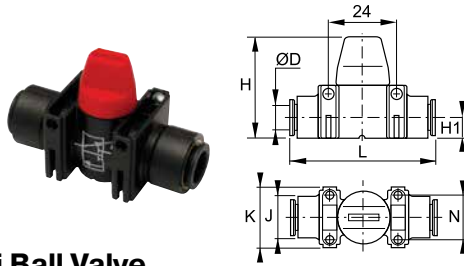

**MVV309 Mini Ball Valve  
Vented Push-To-Connect Ports**

PART NO.	TUBE SIZE IN	H	H1	J	K	L	N
<b>METRIC</b>							
MVV309-4M (5/32)	4	37.00	7.50	15.00	22.00	51	16.20
MVV309-6M	6	37.00	7.50	15.00	22.00	52	16.20
MVV309-8M (5/16)	8	37.00	7.50	15.00	22.00	52	16.20
MVV309-10M	10	43.00	11.00	20.00	30.00	66	22.00
MVV309-12M	12	43.00	11.00	20.00	30.00	66	22.00

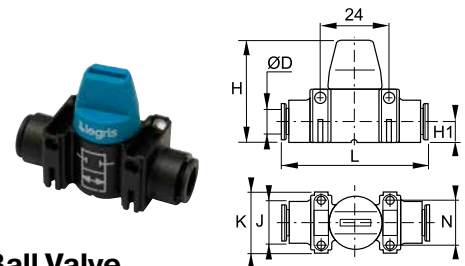

**MV309 Mini Ball Valve  
Push-To-Connect Ports**

PART NO.	TUBE SIZE IN	H	H1	J	K	L	N
<b>METRIC</b>							
MV309-4M (5/32)	4	37.00	7.50	15.00	22.00	51.00	16.20
MV309-6M	6	37.00	7.50	15.00	22.00	52.00	16.20
MV309-8M (5/16)	8	37.00	7.50	15.00	22.00	52.00	16.20
MV309-10M	10	43.00	11.00	20.00	30.00	66.00	16.20
MV309-12M	12	43.00	11.00	20.00	30.00	66.00	16.20

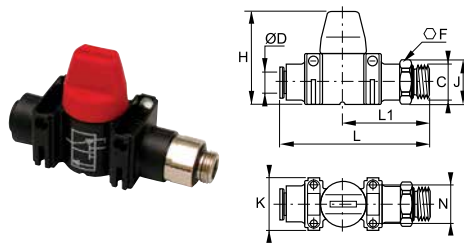

**MVV308 Mini Ball Valve  
Vented BSPP to Push-To-Connect Port**

PART NO.	TUBE SIZE MM	BSPP	F	H	J	K	L	L1	N
MVV308-6M-2G	6	G1/8	13	37	14.00	22	62	37	16.20
MVV308-8M-4G	8	G1/4	16	37	17.50	22	61	35	16.20
MVV308-10M-6G	10	G3/8	20	43	22.00	30	74	41	22.00

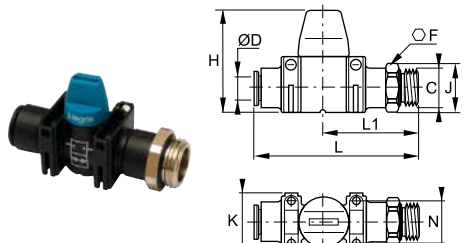

**MV308 Mini Ball Valve  
BSPP to Push-To-Connect Port**

PART NO.	TUBE SIZE MM	BSPP	F	H	J	K	L	L1	N
MV308-6M-2G	6	G1/8	13	37	14	22	62	37	16.20
MV308-10M-6G	10	G3/8	20	43	22	30	74	41	16.20
MV308-12M-8G	12	G1/2	24	43	26	30	75	42	16.20

**WARNING** These products can expose you to chemicals including NICKEL or LEAD, which are known to the state of California to cause cancer, and LEAD which is known to cause birth defects or other reproductive harm. For more information go to [www.P65Warnings.ca.gov](http://www.P65Warnings.ca.gov).



- A
- B
- C
- D
- E
- F
- G
- H
- I
- J
- K
- L
- M
- N
- O



# Water & Beverage: Thermoplastic Fittings and Valves

LIQUIfit Fittings

TrueSeal™ Fittings

Fast & Tite® Fittings

Par-Barb® Fittings



For more product information visit:  
[www.parker.com/water](http://www.parker.com/water)







# LIQUIfit Fittings

Parker's LIQUIfit Fittings offer an innovative alternative for water applications. These fittings ensure reliable and compact connection for liquid transfer applications.

### Product Features:

- Stainless steel grab ring
- Bio-sourced nylon 11
- EPDM D – seal
- FDA compliant, NSF/ANSI 51 and NSF/ANSI/CAN 61
- Silicone free
- 100% leak tested in production
- Date coding to guarantee quality and traceability

### Markets:

- Water Filtration
- Beverage Dispensing
- Life Science
- Bottling
- Semi-Conductor

### Applications:

- Water
- Beverages
- Food
- CO<sub>2</sub>
- Vacuum

### Specifications:

**Pressure Range** Up to 230 PSI ( 16 bar)

**Temperature Range** +35° to +200° F (+1.7° to +93.3° C)

**Note:** The working specification depends on the type and wall thickness of the tube, the type of fluid, fluid Temperature and ambient temperature

### Compatible Tubing:

- Polyethylene

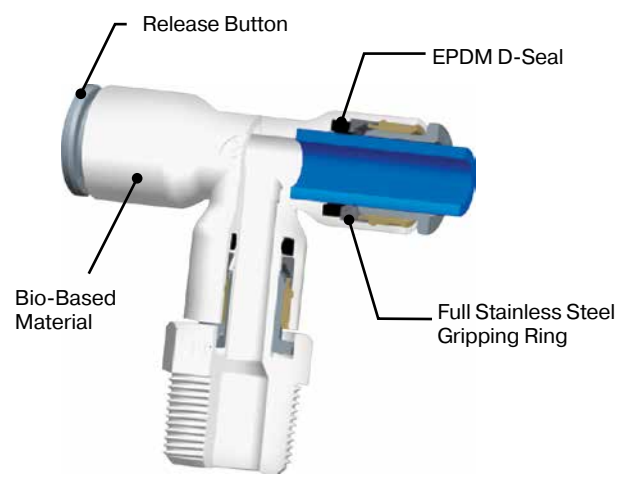

### Assembly Instructions

1. Cut tubing squarely – maximum of 15° angle allowable.
2. Check that port or mating part is clean and free of debris.
3. Mark tubing to appropriate tube insertion length. (see Tube Insertion Chart on page N22)
4. Insert tubing until it bottoms
5. Pull on tubing to verify it is fully inserted
6. To disassemble, simply press release button, hold against body and pull tubing out of fitting.

**WARNING** These products can expose you to chemicals including CARBON BLACK, or LEAD, which are known to the state of California to cause cancer, and LEAD which is known to cause birth defects or other reproductive harm. For more information go to [www.P65Warnings.ca.gov](http://www.P65Warnings.ca.gov).

**Threaded Fittings**

**6505**

Male Connector  
BSPT, NPTF  
p. C7



**6315**

Female Connector  
NPTF, BSPT  
p. C7



**6579**

Male Elbow  
NPTF, BSPT  
p. C8



**6325**

Faucet Connector  
UNS  
p. C8



**6521**

Male Standpipe  
NPTF, BSPT  
p. C8



**6509**

Male Elbow Swivel  
NPTF, BSPT  
p. C8, C9



**6508**

Branch Tee Swivel  
NPTF, BSPT  
p. C9



**AS**

Angle Stop Fitting  
p. C9



**6503**

Run Tee Swivel  
NPTF, BSPT  
p. C9, C10



**6548**

Male Y Connector  
NPTF  
p. C13



**Tube to Tube Fittings**

**6306**

Union  
p. C10



**6304**

Union Tee  
p. C10



**6302**

Union Elbow  
p. C11



**6340**

Union Y  
p. C11



**6307**

Cross  
p. C13



**Bulkhead Union**

**6316**

Bulkhead Union  
p. C7



**Plug-In Fittings**

**6366**

Tube Reducer  
p. C11



**6388**

Plug-In Branch Tee  
p. C12



**6382**

Plug-In Elbow  
p. C12



**6383**

Plug-In Run Tee  
p. C12, C13



**6380**

Plug-In 45° Elbow  
p. C13



**WARNING** These products can expose you to chemicals including CARBON BLACK, or LEAD, which are known to the state of California to cause cancer, and LEAD which is known to cause birth defects or other reproductive harm. For more information go to [www.P65Warnings.ca.gov](http://www.P65Warnings.ca.gov).



- A
- B
- C
- D
- E
- F
- G
- H
- I
- J
- K
- L
- M
- N
- O

**Ball Valves**

**VME**  
Male Elbow  
p. C14



**VUC**  
Union Connector  
p. C14



**VFE**  
Female Elbow  
p. C15



**VEU**  
Elbow Union  
p. C15



**VMC**  
Male Connector  
p. C15



**VFC**  
Female Connector  
p. C15



**VUCPB**  
Valve Union  
Connector  
p. C16



**VAS**  
Valve Angle Stop  
p. C16



**BVC**  
Ball Valve Clip  
p. C16



**Accessories**

**6351**  
End Cap  
p. C12



**6326**  
Plug  
p. C13



**6322**  
Barbed Connector  
p. C13



**WARNING** These products can expose you to chemicals including CARBON BLACK, or LEAD, which are known to the state of California to cause cancer, and LEAD which is known to cause birth defects or other reproductive harm. For more information go to [www.P65Warnings.ca.gov](http://www.P65Warnings.ca.gov).



Click here for CADs, Product Specifications or to Configure Parts Online

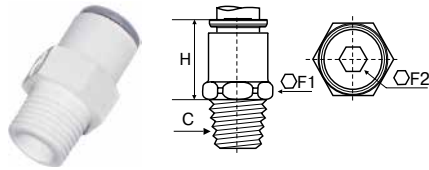

### 6505 Male Connector Inch Tube to NPTF

PART NO.	TUBE SIZE IN	C NPTF	F1	F2	H
6505 56 11WP2	1/4	1/8	1/2	5/32	.67
6505 56 14WP2	1/4	1/4	9/16	5/32	.67
6505 56 18WP2	1/4	3/8	3/4	1/4	.85
6505 60 11WP2	3/8	1/8	3/4	5/32	.87
6505 60 14WP2	3/8	1/4	3/4	1/4	.87
6505 60 18WP2	3/8	3/8	3/4	1/4	.87
6505 60 22WP2	3/8	1/2	15/16	1/4	1.06
6505 62 18WP2	1/2	3/8	15/16	3/8	1.10
6505 62 22WP2	1/2	1/2	15/16	3/8	1.10

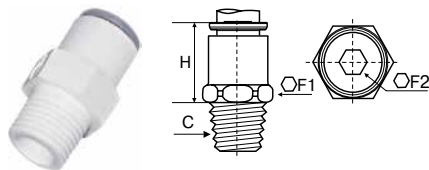

### 6505 Male Connector Metric Tube to BSPT

PART NO.	TUBE SIZE MM	C BSPT	F1	F2	H
6505 04 10WP2	4	1/8	11	3	18.00
6505 06 10WP2	6	1/8	11	4	18.00
6505 06 13WP2	6	1/4	14	4	18.00
6505 08 10WP2	8	1/8	17	6	20.00
6505 08 13WP2	8	1/4	17	6	20.00
6505 08 17WP2	8	3/8	17	6	20.00
6505 10 13WP2	10	1/4	17	7	21.50
6505 10 17WP2	10	3/8	19	7	21.50
6505 10 21WP2	10	1/2	22	7	21.50
6505 12 17WP2	12	3/8	19	9	24.50
6505 12 21WP2	12	1/2	22	9	24.50

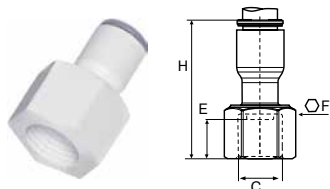

### 6315 Female Connector Inch Tube to NPTF

PART NO.	TUBE SIZE IN	C NPTF	E	F	H
6315 56 14WP2	1/4	1/4	14	11/16	1.18
6315 60 18WP2	3/8	3/8	14	3/16	1.42

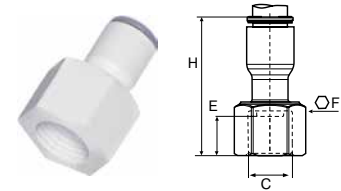

### 6315 Female Connector Metric Tube to BSPT

PART NO.	TUBE SIZE MM	C BSPT	E	F	H
6315 06 10WP2	6	1/8	11	13	32.00
6315 06 13WP2	6	1/4	14	16	33.00
6315 08 13WP2	8	1/4	14	16	33.50

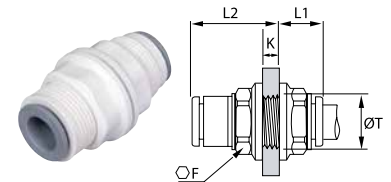

### 6316 Bulkhead Union Inch Tube

PART NO.	TUBE SIZE IN	F	K MAX	L1	L2	T MIN
6316 04 00WP2	5/32	.51	.22	.41	.61	.41
6316 56 00WP2	1/4	.59	.33	.39	.79	.49
6316 08 00WP2	5/16	.71	.57	.41	1.06	.61
6316 60 00WP2	3/8	.87	.57	.49	1.16	.73
6316 62 00WP2	1/2	1.41	.81	.67	1.59	1.00

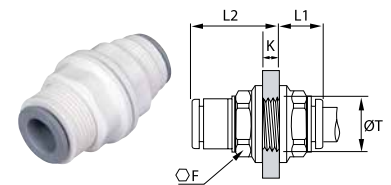

### 6316 Bulkhead Union Metric Tube

PART NO.	TUBE SIZE MM	F	K MAX	L1	L2	T MIN
6316 04 00WP2	4	13	5.50	10.50	15.50	10.50
6316 06 00WP2	6	15	8.50	10.00	20.00	12.50
6316 08 00WP2	8	18	14.50	10.50	27.00	15.50

**WARNING** These products can expose you to chemicals including CARBON BLACK, or LEAD, which are known to the state of California to cause cancer, and LEAD which is known to cause birth defects or other reproductive harm. For more information go to [www.P65Warnings.ca.gov](http://www.P65Warnings.ca.gov).

- A
- B
- C
- D
- E
- F
- G
- H
- I
- J
- K
- L
- M
- N
- O

Click here for CADs, Product Specifications or to Configure Parts Online

- A
- B
- C
- D
- E
- F
- G
- H
- I
- J
- K
- L
- M
- N
- O

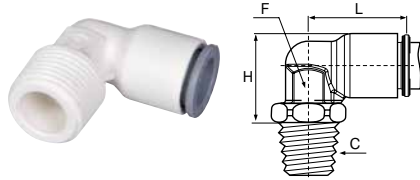

**6579 Fixed Elbow Inch Tube to NPTF**

PART NO.	TUBE SIZE IN	C NPTF	F	H	L
6579 56 11WP2	1/4	1/8	3/8	.54	.71
6579 56 14WP2	1/4	1/4	3/8	.54	.71
6579 56 18WP2	1/4	3/8	3/8	.54	.71
6579 60 14WP2	3/8	1/4	1/2	.77	1.02
6579 60 18WP2	3/8	3/8	1/2	.77	1.02

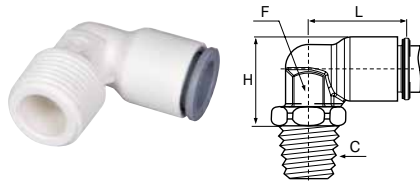

**6579 Fixed Elbow Metric Tube to BSPT**

PART NO.	TUBE SIZE MM	C BSPT	F	H	L
6579 06 10WP2	6	1/8	10	14	19
6579 06 13WP2	6	1/4	10	14	19
6579 06 17WP2	6	3/8	10	14	19

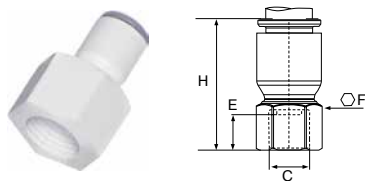

**6325 Faucet Connector Inch Tube to UNS**

PART NO.	TUBE SIZE IN	C UNS	E	F	H
6325 56 133WP2	1/4	7/16-24	27	9/16	1.22
6325 60 133WP2	3/8	7/16-24	27	9/16	1.26

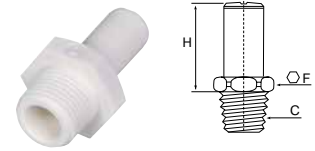

**6521 Stem Adapter Inch Tube to NPTF**

PART NO.	TUBE SIZE IN	C NPTF	F	H
6521 56 11WP2	1/4	1/8	1/2	.75
6521 56 14WP2	1/4	1/4	1/2	.75
6521 56 18WP2	1/4	3/8	3/4	.77
6521 60 14WP2	3/8	1/4	3/4	.98
6521 60 18WP2	3/8	3/8	3/4	.98
6521 62 18WP2	1/2	3/8	15/16	1.22
6521 62 22WP2	1/2	1/2	15/16	1.28

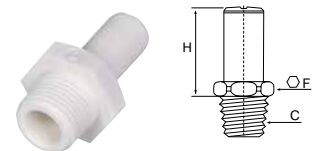

**6521 Stem Adapter Metric Tube to BSPT**

PART NO.	TUBE SIZE MM	C BSPT	F	H
6521 06 10WP2	6	1/8	13	19
6521 06 13WP2	6	1/4	14	19
6521 06 17WP2	6	3/8	17	19
6521 08 10WP2	8	1/8	19	23
6521 08 13WP2	8	1/4	19	23
6521 08 17WP2	8	3/8	19	23
6521 10 13WP2	10	1/4	19	25
6521 10 17WP2	10	3/8	19	25
6521 10 21WP2	10	1/2	22	25
6521 12 17WP2	12	3/8	22	28
6521 12 21WP2	12	1/2	22	28

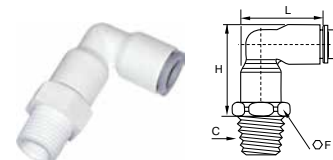

**6509 Swivel Elbow Inch Tube to NPTF**

PART NO.	TUBE SIZE IN	C NPTF	F	H	L
6509 56 11WP2	1/4	1/8	1/2	1.10	.93
6509 56 14WP2	1/4	1/4	9/16	1.10	.93
6509 56 18WP2	1/4	3/8	3/4	1.12	.93
6509 60 14WP2	3/8	1/4	3/4	1.50	1.34
6509 60 18WP2	3/8	3/8	3/4	1.50	1.34
6509 62 18WP2	1/2	3/8	15/16	1.99	1.83
6509 62 22WP2	1/2	1/2	15/16	1.99	1.83

**WARNING** These products can expose you to chemicals including CARBON BLACK, or LEAD, which are known to the state of California to cause cancer, and LEAD which is known to cause birth defects or other reproductive harm. For more information go to [www.P65Warnings.ca.gov](http://www.P65Warnings.ca.gov).



Click here for CADs, Product Specifications or to Configure Parts Online

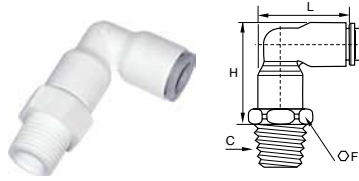

### 6509 Swivel Elbow Metric Tube to BSPT

PART NO.	TUBE SIZE MM	C BSPT	F	H	L
6509 06 10WP2	6	1/8	13	28	24.00
6509 06 13WP2	6	1/4	14	28	24.00
6509 06 17WP2	6	3/8	17	28	24.00
6509 08 10WP2	8	1/8	19	34	29.50
6509 08 13WP2	8	1/4	19	34	29.50
6509 08 17WP2	8	3/8	19	34	29.50
6509 12 17WP2	12	3/8	22	44	40.00
6509 12 21WP2	12	1/2	22	44	40.00

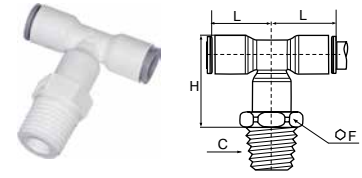

### 6508 Swivel Branch Tee Metric Tube to BSPT

PART NO.	TUBE SIZE MM	C BSPT	F	H	L
6508 06 10WP2	6	1/8	13	28.00	18.00
6508 06 13WP2	6	1/4	14	28.00	18.00
6508 06 17WP2	6	3/8	17	28.00	18.00
6508 08 10WP2	8	1/8	19	34.00	23.00
6508 10 13WP2	10	1/4	19	38.00	26.50
6508 10 21WP2	10	1/2	22	38.00	26.50
6508 12 17WP2	12	3/8	22	44.00	31.00

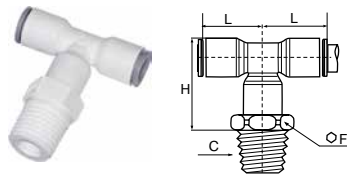

### 6508 Swivel Branch Tee Inch Tube to NPTF

PART NO.	TUBE SIZE IN	C NPTF	F	H	L
6508 56 11WP2	1/4	1/8	1/2	1.10	.71
6508 56 14WP2	1/4	1/4	9/16	1.10	.71
6508 56 18WP2	1/4	3/8	3/4	1.10	.71
6508 60 14WP2	3/8	1/4	3/4	1.50	1.02
6508 60 18WP2	3/8	3/8	3/4	1.50	1.02
6508 62 18WP2	1/2	3/8	15/16	1.97	1.40
6508 62 22WP2	1/2	1/2	15/16	2.00	1.40

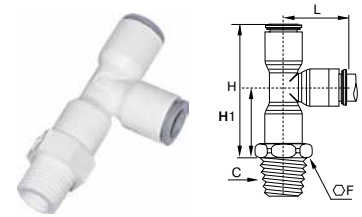

### 6503 Swivel Run Tee Inch Tube to NPTF

PART NO.	TUBE SIZE IN	C NPTF	F	H	H1	L
6503 56 11WP2	1/4	1/8	1/2	1.60	.88	.71
6503 56 14WP2	1/4	1/4	9/16	1.60	.88	.71
6503 56 18WP2	1/4	3/8	3/4	1.63	.90	.71
6503 60 14WP2	3/8	1/4	3/4	1.63	1.18	1.02
6503 60 18WP2	3/8	3/8	3/4	1.63	1.18	1.02
6503 62 18WP2	1/2	3/8	15/16	2.29	1.55	1.40
6503 62 22WP2	1/2	1/2	15/16	2.99	1.59	1.40

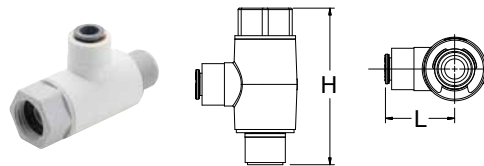

### AS Angle Stop Fitting

PART NO.	TUBE SIZE IN	MALE THD.	FEMALE THD.	UNEF THD.	H	L
LFPP4AS6	1/4	3/8	3/8	9/16-24	2.17	.96

**WARNING** These products can expose you to chemicals including CARBON BLACK, or LEAD, which are known to the state of California to cause cancer, and LEAD which is known to cause birth defects or other reproductive harm. For more information go to [www.P65Warnings.ca.gov](http://www.P65Warnings.ca.gov).

- A
- B
- C
- D
- E
- F
- G
- H
- I
- J
- K
- L
- M
- N
- O

Click here for CADs, Product Specifications or to Configure Parts Online

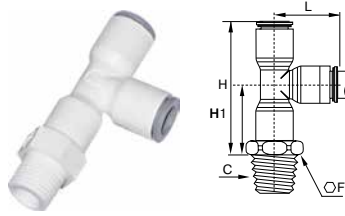

### 6503 Swivel Run Tee Metric Tube to BSPT

PART NO.	TUBE SIZE MM	C BSPT	F	H	H1	L
6503 06 13WP2	6	1/4	14	40.00	22.00	18.50
6503 08 10WP2	8	1/8	19	50.00	27.00	23.00
6503 08 13WP2	8	1/4	19	50.00	27.00	23.00
6503 08 17WP2	8	3/8	19	50.00	27.00	23.00
6503 12 17WP2	12	3/8	22	65.50	34.50	31.00
6503 12 21WP2	12	1/2	22	65.50	34.50	31.00

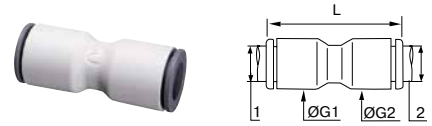

### 6306 Union Connector Metric Tube

PART NO.	TUBE 1 SIZE MM	TUBE 2 SIZE MM	G1	G2	L
6306 04 00WP2	4	4	8.50	8.50	26.50
6306 06 00WP2	6	6	10.50	10.50	30.00
6306 08 00WP2	8	8	13.50	13.50	37.00
6306 10 00WP2	10	10	16.00	16.00	42.00
6306 12 00WP2	12	12	19.00	19.00	50.50
6306 04 06WP2	4	6	8.50	10.50	29.00
6306 04 08WP2	4	8	13.50	13.50	37.00
6306 06 08WP2	6	8	13.50	13.50	37.00
6306 06 10WP2	6	10	16.00	16.00	42.00
6306 08 10WP2	8	10	16.00	16.00	42.00
6306 08 12WP2	8	12	19.00	19.00	50.00
6306 10 12WP2	10	12	19.00	19.00	50.00

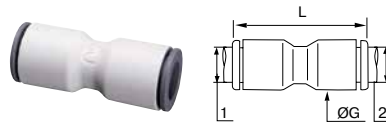

### 6306 Union Connector Inch Tube

PART NO.	TUBE 1 SIZE IN	TUBE 2 SIZE IN	G	L
6306 56 00WP2	1/4	1/4	.43	1.18
6306 08 00WP2	5/16	5/16	.53	1.46
6306 60 00WP2	3/8	3/8	.63	1.65
6306 62 00WP2	1/2	1/2	.87	2.24
6306 56 60WP2	1/4	3/8	.63	1.61
6306 56 08WP2	1/4	5/16	.53	1.46
6306 08 60WP2	5/16	3/8	.63	1.65
6306 08 62WP2	5/16	1/2	.87	2.16
6306 60 62WP2	3/8	1/2	.87	2.20

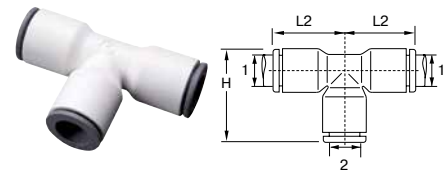

### 6304 Union Tee Inch Tube

PART NO.	TUBE 1 SIZE IN	TUBE 2 SIZE IN	H	L2
6304 04 00WP2	5/32	5/32	.79	.61
6304 56 00WP2	1/4	1/4	.94	.71
6304 08 00WP2	5/16	5/16	1.14	.89
6304 60 00WP2	3/8	3/8	1.34	1.02
6304 62 00WP2	1/2	1/2	1.85	1.42
6304 60 56WP2	3/8	1/4	1.34	1.02
6304 62 60WP2	1/2	3/8	1.85	1.42

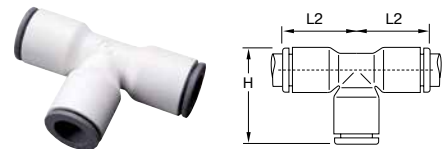

### 6304 Union Tee Metric Tube

PART NO.	TUBE SIZE MM	H	L2
6304 04 00WP2	4	20.00	15.50
6304 06 00WP2	6	23.00	18.00
6304 08 00WP2	8	29.00	22.50
6304 10 00WP2	10	34.50	26.50
6304 12 00WP2	12	40.00	31.00

**WARNING** These products can expose you to chemicals including CARBON BLACK, or LEAD, which are known to the state of California to cause cancer, and LEAD which is known to cause birth defects or other reproductive harm. For more information go to [www.P65Warnings.ca.gov](http://www.P65Warnings.ca.gov).



[Click here for CADs, Product Specifications or to Configure Parts Online](#)

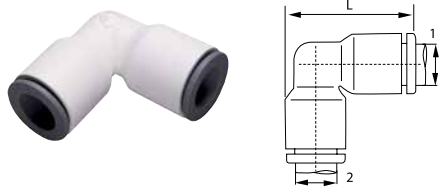

### 6302 Union Elbow Inch Tube

PART NO.	TUBE 1 SIZE IN	TUBE 2 SIZE IN	L
6302 04 00WP2	5/32	5/32	.75
6302 56 00WP2	1/4	1/4	.94
6302 08 00WP2	5/16	5/16	1.16
6302 60 00WP2	3/8	3/8	1.34
6302 62 00WP2	1/2	1/2	1.83
6302 56 08WP2	1/4	5/16	1.16
6302 08 60WP2	5/16	3/8	1.34
6302 56 60WP2	3/8	1/4	1.30
6302 60 62WP2	3/8	1/2	1.83

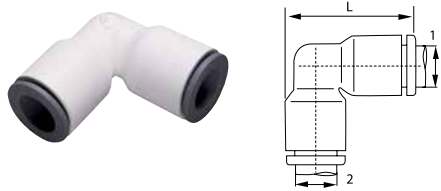

### 6302 Union Elbow Metric Tube

PART NO.	TUBE 1 SIZE MM	TUBE 2 SIZE MM	L
6302 04 00WP2	4	4	19.50
6302 06 00WP2	6	6	24.00
6302 08 00WP2	8	8	29.50
6302 10 00WP2	10	10	34.50
6302 12 00WP2	12	12	40.50
6302 04 06WP2	4	6	24.00
6302 06 08WP2	6	8	29.50
6302 08 10WP2	8	10	34.50
6302 10 12WP2	10	12	40.50

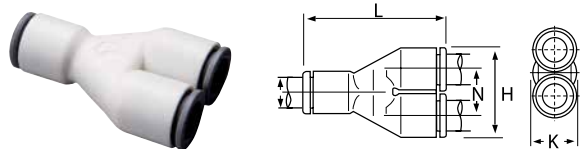

### 6340 Union Y Connector Inch Tube

PART NO.	TUBE SIZE IN	H	K	L	N
6340 04 00WP2	5/32	.69	.33	1.18	.35
6340 56 00WP2	1/4	.87	.43	1.42	.45
6340 08 00WP2	5/16	1.10	.53	1.75	.57
6340 60 00WP2	3/8	1.30	.63	2.08	.67
6340 62 00WP2	1/2	1.77	.87	2.64	.91

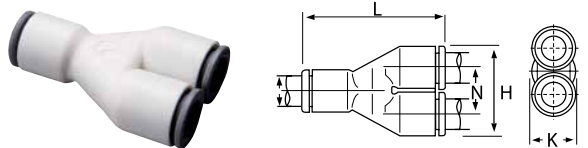

### 6340 Union Y Connector Metric Tube

PART NO.	TUBE SIZE MM	H	K	L	N
6340 04 00WP2	4	17.50	8.50	30.00	9.00
6340 06 00WP2	6	21.50	10.50	36.50	11.00
6340 08 00WP2	8	28.00	13.50	44.50	14.50
6340 10 00WP2	10	33.00	16.00	53.00	17.00
6340 12 00WP2	12	39.00	19.00	60.50	20.00

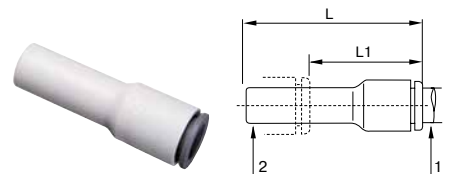

### 6366 Reducer Inch Tube to Stem

PART NO.	TUBE 1 SIZE IN	TUBE 2 SIZE IN	L	L1
6366 56 08WP2	1/4	5/16	1.61	.89
6366 56 60WP2	1/4	3/8	1.61	.81
6366 08 60WP2	5/16	3/8	1.91	1.14
6366 08 62WP2	5/16	1/2	1.91	.87
6366 60 62WP2	3/8	1/2	2.01	1.18

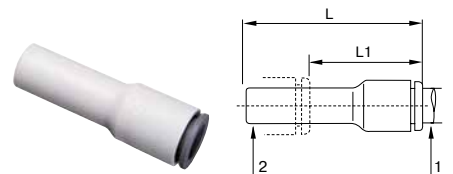

### 6366 Reducer Metric Tube to Stem

PART NO.	TUBE 1 SIZE MM	TUBE 2 SIZE MM	L	L1
6366 04 06WP2	4	6	38.00	23.50
6366 04 08WP2	4	8	38.00	19.00
6366 06 08WP2	6	8	38.00	20.00
6366 06 10WP2	6	10	39.00	17.50
6366 08 10WP2	8	10	48.50	28.50
6366 08 12WP2	8	12	48.50	24.50
6366 10 12WP2	10	12	52.00	33.50
6366 10 14WP2	10	14	53.00	33.50
6366 12 14WP2	12	14	55.50	33.50

**WARNING** These products can expose you to chemicals including CARBON BLACK, or LEAD, which are known to the state of California to cause cancer, and LEAD which is known to cause birth defects or other reproductive harm. For more information go to [www.P65Warnings.ca.gov](http://www.P65Warnings.ca.gov).



- A
- B
- C
- D
- E
- F
- G
- H
- I
- J
- K
- L
- M
- N
- O

Click here for CADs, Product Specifications or to Configure Parts Online

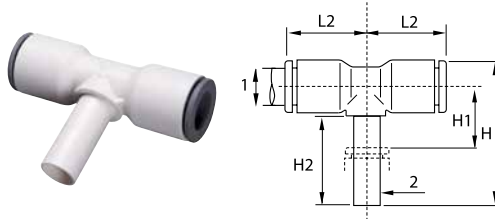

### 6388 Plug-In Tee Inch Tube to Stem

PART NO.	TUBE 1 SIZE IN	TUBE 2 SIZE IN	H	H1	H2	L2
6388 56 00WP2	1/4	1/4	1.20	.43	.79	.71
6388 08 00WP2	5/16	5/16	1.32	.31	.85	.90
6388 60 00WP2	3/8	3/8	1.65	.49	.98	.98
6388 62 00WP2	1/2	1/2	2.01	.51	1.14	1.26

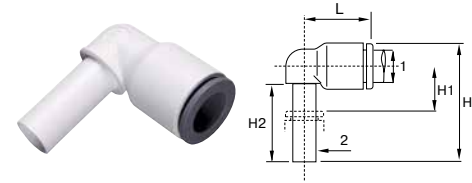

### 6382 Plug-In Elbow Inch Tube to Stem

PART NO.	TUBE 1 SIZE IN	TUBE 2 SIZE IN	H	H1	H2	L
6382 56 00WP2	1/4	1/4	1.20	.43	.71	.71
6382 08 00WP2	5/16	5/16	1.32	.31	.85	.88
6382 60 00WP2	3/8	3/8	1.53	.35	.96	1.04
6382 56 60WP2	1/4	3/8	1.93	.51	1.12	1.42
6382 60 56WP2	3/8	1/4	1.26	.43	.71	1.04

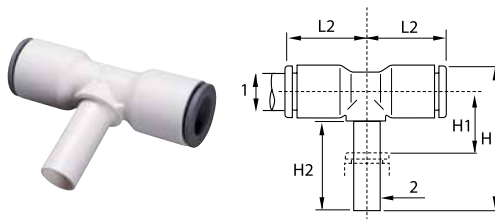

### 6388 Plug-In Tee Metric Tube to Stem

PART NO.	TUBE 1 SIZE MM	TUBE 2 SIZE MM	H	H1	H2	L2
6388 04 00WP2	4	4	25.00	6.00	15.50	15.00
6388 06 00WP2	6	6	28.50	7.00	17.00	16.00
6388 08 00WP2	8	8	33.50	8.00	21.50	23.00
6388 10 00WP2	10	10	41.00	9.50	24.50	26.50

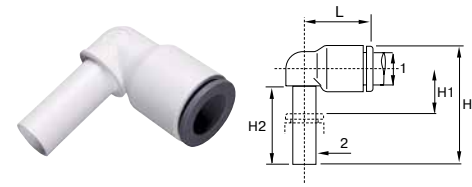

### 6382 Plug-In Elbow Metric Tube to Stem

PART NO.	TUBE 1 SIZE MM	TUBE 2 SIZE MM	H	H1	H2	L
6382 04 00WP2	4	4	23.00	6.00	15.50	15.00
6382 06 00WP2	6	6	26.50	7.00	17.00	17.00
6382 08 00WP2	8	8	33.00	8.00	21.50	22.50
6382 10 00WP2	10	10	39.00	9.50	24.50	26.50
6382 12 00WP2	12	12	44.50	10.00	27.00	31.00
6382 04 06WP2	4	6	26.50	7.00	17.00	16.50
6382 06 04WP2	6	4	25.00	7.00	15.50	17.00
6382 06 08WP2	6	8	33.50	8.00	21.50	22.50

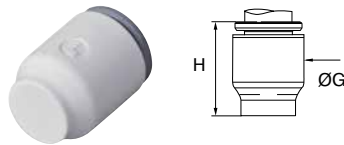

### 6351 End Stop Inch Tube

PART NO.	TUBE SIZE IN	G	H
6351 04 00WP2	5/32	.33	.59
6351 56 00WP2	1/4	.43	.63
6351 08 00WP2	5/16	.53	.85
6351 60 00WP2	3/8	.63	.88

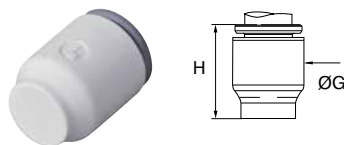

### 6351 End Stop Metric Tube

PART NO.	TUBE SIZE MM	G	H
6351 04 00WP2	4	8.50	15.00
6351 06 00WP2	6	10.50	17.00
6351 08 00WP2	8	13.50	21.50
6351 10 00WP2	10	16.00	22.00

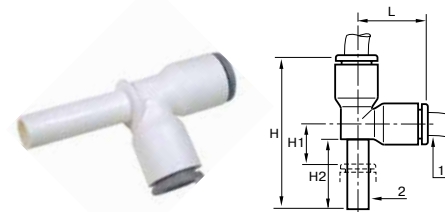

### 6383 Plug-In Run Tee Inch Tube to Stem

PART NO.	TUBE 1 SIZE IN	TUBE 2 SIZE IN	H	H1	H2	L
6383 56 00WP2	1/4	1/4	1.20	.43	.71	.71
6383 60 00WP2	3/8	3/8	2.24	.43	.96	1.04
6383 62 00WP2	1/2	1/2	1.93	.71	1.12	1.42

**WARNING** These products can expose you to chemicals including CARBON BLACK, or LEAD, which are known to the state of California to cause cancer, and LEAD which is known to cause birth defects or other reproductive harm. For more information go to [www.P65Warnings.ca.gov](http://www.P65Warnings.ca.gov).



Click here for CADs, Product Specifications or to Configure Parts Online

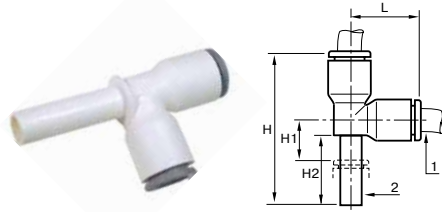

**6383 Plug-In Run Tee Metric Tube to Stem**

PART NO.	TUBE 1 SIZE MM	TUBE 2 SIZE MM	H	H1	H2	L
6383 04 00WP2	4	4	33.00	6.00	15.50	15.00
6383 06 00WP2	6	6	38.50	7.00	17.00	18.00
6383 08 00WP2	8	8	49.00	8.00	21.50	23.00
6383 10 00WP2	10	10	57.00	10.50	25.50	26.50

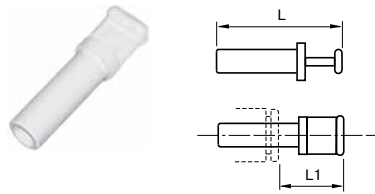

**6326 Plug Inch**

PART NUMBER	STEM SIZE IN	L	L1
6326 56 00WP2	1/4	1.44	.87
6326 08 00WP2	5/16	1.38	.69
6326 60 00WP2	3/8	1.67	.87
6326 62 00WP2	1/2	1.91	.85

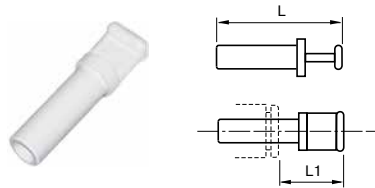

**6326 Plug Metric**

PART NUMBER	STEM SIZE MM	L	L1
6326 04 00WP2	4	30	15.5
6326 06 00WP2	6	33	16.5
6326 08 00WP2	8	33	17.5

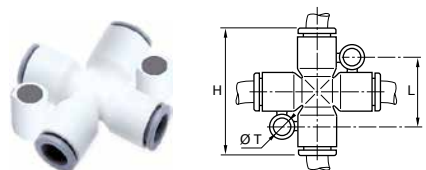

**6307 Cross Metric**

PART NUMBER	TUBE SIZE MM	H	L	T
6307 06 00WP2	6	46	22.5	4.2
6307 08 00WP2	8	46	22.5	4.2

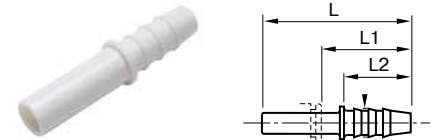

**6322 Stem to Hose Barb Inch**

PART NUMBER	STEM SIZE IN	HOSE BARB	L	L1	L2
6322 56 56WP2	1/4	1/4	1.65	1.00	.67
6322 60 56WP2	3/8	1/4	1.97	1.16	.87
6322 60 08WP2	3/8	5/16	1.97	1.16	.87
6322 60 60WP2	3/8	3/8	1.97	1.16	.87
6322 62 60WP2	1/2	3/8	2.05	1.30	1.07

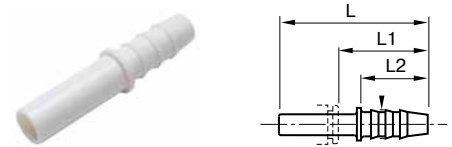

**6322 Stem to Hose Barb Metric**

PART NUMBER	STEM SIZE MM	HOSE BARB	L	L1	L2
6322 06 04WP2	6	4	37.0	25.0	17
6322 08 06WP2	8	6	39.5	21.0	17
6322 10 07WP2	10	7	50.0	29.5	22

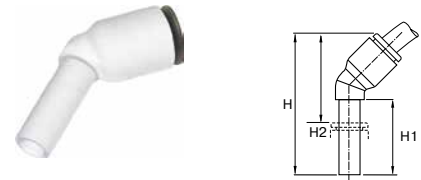

**6380 Plug-in 45° Elbow Metric**

PART NUMBER	TUBE SIZE MM	STEM SIZE MM	H	H1	H2
6380 04 00WP2	4	4	33.5	19.0	13.0
6380 06 00WP2	6	6	39.0	21.0	14.5
6380 08 00WP2	8	8	44.0	21.5	19.5
6380 10 00WP2	10	10	53.0	27.0	23.0
6380 12 00WP2	12	12	58.5	27.5	26.5

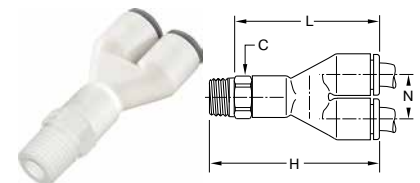

**6548 Swivel Y Connector Inch Tube to NPTF**

PART NUMBER	TUBE SIZE IN	NPTF	C HEX	L	H	N
6548 56 11WP2	1/4	1/8	1/2	1.59	.88	.45
6548 56 14WP2	1/4	1/4	1/2	1.59	.88	.45
6548 56 18WP2	1/4	3/8	3/4	1.62	.88	.45
6548 60 14WP2	3/8	1/4	3/4	2.24	1.30	.66
6548 60 18WP2	3/8	3/8	3/4	2.24	1.30	.66
6548 62 18WP2	1/2	3/8	15/16	2.80	1.78	.91
6548 62 22WP2	1/2	1/2	15/16	2.84	1.78	.91

**WARNING** These products can expose you to chemicals including CARBON BLACK, or LEAD, which are known to the state of California to cause cancer, and LEAD which is known to cause birth defects or other reproductive harm. For more information go to [www.P65Warnings.ca.gov](http://www.P65Warnings.ca.gov).



- A
- B
- C
- D
- E
- F
- G
- H
- I
- J
- K
- L
- M
- N
- O

[Click here for CADs, Product Specifications or to Configure Parts Online](#)

A

### LIQUIfit Polypropylene Ball Valves

This range of valves offers an innovative solution in the treatment of water and the handling of beverages while protecting health. LIQUIfit's corrosion-resistant, all plastic design makes them ideal for water filtration units, coffee and beverage machines and a wide variety of other fluid applications. The polypropylene material meets all FDA and NSF-51 requirements for food contact.

#### Assembly Instructions:

1. Inspect the mating threads for debris or damage. Remove any old fluoropolymer tape or sealant on previously used threads. If threads are damaged, replace with new adapter before proceeding.
2. Apply 2 to 3 wraps of fluoropolymer tape, or an NSF/FDA approved silicone sealant. Do not use Plumbers Putty or Pipe Dope. These chemically react with plastic materials and could cause a failure.
3. Align ball valve onto mating thread to ensure cross threading does not occur.
4. Screw ball valve onto mating thread 3 to 5 turns. This should be sufficient to properly seal the threads.
5. Pressurize system and check for leaks.

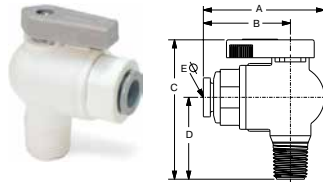

#### VME - Valve Male Elbow

PART NO.	NOM. TUBE O.D.	NPTF THREAD SIZE	A	B	C	D	ØE THRU HOLE MIN.
LFPP4VME2	1/4	1/8	1.74	1.21	2.00	1.10	.19
LFPP4VME4	1/4	1/4	1.74	1.21	2.18	1.28	.19
LFPP4VME6	1/4	3/8	1.74	1.21	2.18	1.28	.19
LFPP4VME8	1/4	1/2	1.74	1.21	2.37	1.47	.19
LFPP6VME2	3/8	1/8	1.85	1.32	2.00	1.10	.25
LFPP6VME4	3/8	1/4	1.85	1.32	2.18	1.28	.25
LFPP6VME6	3/8	3/8	1.85	1.32	2.18	1.28	.25
LFPP6VME8	3/8	1/2	1.85	1.32	2.37	1.47	.25
LFPP8VME8	1/2	1/2	2.73	1.74	2.38	1.47	.37

B

C

D

E

F

G

H

I

J

K

L

M

N

O

#### Features/Benefits:

- Full-flow self-cleaning ball maintains the cleanliness of the circuit
- Sealing technology using EPDM D seal
- High temperature, scale-resistant Polysulfone ball
- Tube retention with gripping ring prevents pumping effect
- Push-in connection and disconnection
- FDA compliant

#### Specifications:

- Temperature range: +35° F to +200° F (+1° C to +93° C)
- O-ring seal material: EPDM
- NSF/ANSI 51 and NSF/ANSI/CAN 61
- Pressure rated to 150 psi

#### Advantages:

- Reduce costs – Built-in LIQUIfit connection eliminates the need for a secondary fitting
- Save space – Low profile design allows for easy assembly and access where space is at a premium.

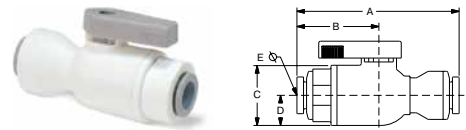

#### VUC - Valve Union Connector

PART NO.	1 TUBE SIZE	2 TUBE SIZE	A	B	C	D	ØE THRU HOLE MIN.
LFPP4VUC4	1/4	1/4	2.23	1.07	1.00	.50	.19
LFPP4VUC6	1/4	3/8	2.50	1.07	1.00	.50	.19
LFPP6VUC6	3/8	3/8	2.74	1.32	1.00	.50	.25
LFPP8VUC8	1/2	1/2	3.50	1.74	1.04	.52	.37

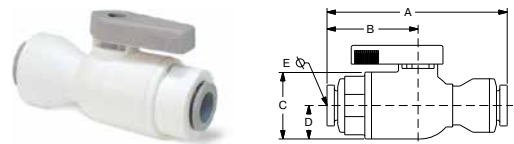

#### VUC - Valve Union Connector Metric

PART NO.	1 TUBE SIZE	2 TUBE SIZE	A	B	C	D	ØE THRU HOLE MIN.
LFPP6MVUC6M	6	6	2.24	.27	.36	.13	.19
LFPP8MVUC8M	8	8	2.35	.27	.36	.13	.25
LFPP10MVUC10M	10	10	2.73	.33	.36	.13	.33
LFPP12MVUC12M	12	12	3.46	.43	.36	.13	.37

NOTE: PPL refers to Polypropylene. FCB refers to Fluorocarbon.

**WARNING** These products can expose you to chemicals including CARBON BLACK, or LEAD, which are known to the state of California to cause cancer, and LEAD which is known to cause birth defects or other reproductive harm. For more information go to [www.P65Warnings.ca.gov](http://www.P65Warnings.ca.gov).



Click here for CADs, Product Specifications or to Configure Parts Online

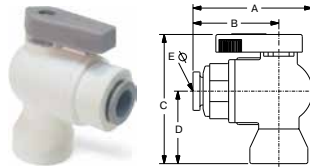

### VFE - Valve Female Elbow

PART NO.	NOM. TUBE O.D.	NPTF THREAD SIZE	A	B	C	D	ØE THRU HOLE MIN.
LFPP4VFE2	1/4	1/8	1.74	1.21	1.82	.92	.19
LFPP4VFE4	1/4	1/4	1.74	1.21	2.05	1.15	.19
LFPP4VFE6	1/4	3/8	1.74	1.21	2.18	1.28	.19
LFPP6VFE2	3/8	1/8	1.85	1.32	1.82	.92	.25
LFPP6VFE4	3/8	1/4	1.85	1.32	2.05	1.15	.25
LFPP6VFE6	3/8	3/8	1.85	1.32	2.18	1.28	.25

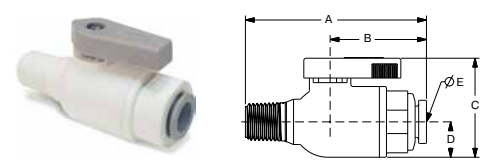

### VMC - Valve Male Connector

PART NO.	NOM. TUBE O.D.	NPTF THREAD SIZE	A	B	C	D	ØE THRU HOLE MIN.
LFPP4VMC2	1/4	1/8	2.22	1.21	1.40	.50	.19
LFPP4VMC4	1/4	1/4	2.40	1.21	1.40	.50	.19
LFPP4VMC6	1/4	3/8	2.40	1.21	1.40	.50	.19
LFPP4VMC8	1/4	1/2	2.59	1.21	1.40	.50	.19
LFPP6VMC2	3/8	1/8	2.33	1.32	1.40	.50	.25
LFPP6VMC4	3/8	1/4	2.51	1.32	1.40	.50	.25
LFPP6VMC6	3/8	3/8	2.51	1.32	1.40	.50	.25
LFPP6VMC8	3/8	1/2	2.70	1.32	1.40	.50	.25
LFPP8VMC8	1/2	1/2	3.14	1.74	1.40	.50	.37

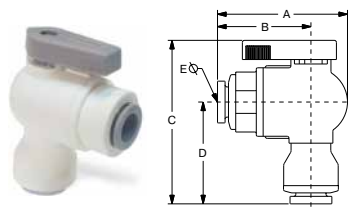

### VEU - Valve Elbow Union

PART NO.	1 TUBE SIZE	2 TUBE SIZE	A	B	C	D	ØE THRU HOLE MIN.
LFPP4VEU4	1/4	1/4	1.75	1.22	2.33	1.42	.19
LFPP4VEU6	1/4	3/8	1.75	1.22	2.33	1.42	.19
LFPP6VEU4	3/8	1/4	1.83	1.30	2.32	1.40	.19
LFPP6VEU6	3/8	3/8	1.85	1.32	2.34	1.44	.25

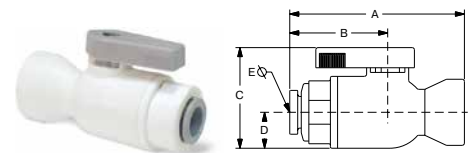

### VFC - Valve Female Connector

PART NO.	NOM. TUBE O.D.	NPTF THREAD SIZE	A	B	C	D	ØE THRU HOLE MIN.
LFPP4VFC2	1/4	1/8	2.04	1.21	1.40	.50	.19
LFPP4VFC4	1/4	1/4	2.27	1.21	1.40	.50	.19
LFPP4VFC6	1/4	3/8	2.40	1.21	1.40	.50	.19
LFPP6VFC2	3/8	1/8	2.15	1.32	1.40	.50	.25
LFPP6VFC4	3/8	1/4	2.38	1.32	1.40	.50	.25
LFPP6VFC6	3/8	3/8	2.51	1.32	1.40	.50	.25

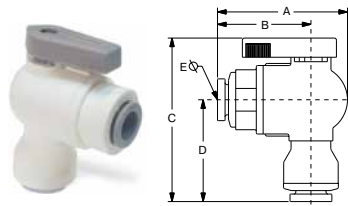

### VEU - Valve Elbow Union Metric

PART NO.	1 TUBE SIZE	2 TUBE SIZE	A	B	C	D	ØE THRU HOLE MIN.
LFPP6MVEU6M	6	6	.41	.27	.55	.31	.19
LFPP8MVEU8M	8	8	.41	.28	.56	.33	.25
LFPP10MVEU10M	10	10	.48	.33	.61	.38	.33

NOTE: PPL refers to Polypropylene. FCB refers to Fluorocarbon.

**WARNING** These products can expose you to chemicals including CARBON BLACK, or LEAD, which are known to the state of California to cause cancer, and LEAD which is known to cause birth defects or other reproductive harm. For more information go to [www.P65Warnings.ca.gov](http://www.P65Warnings.ca.gov).



- A
- B
- C
- D
- E
- F
- G
- H
- I
- J
- K
- L
- M
- N
- O

[Click here for CADs, Product Specifications or to Configure Parts Online](#)

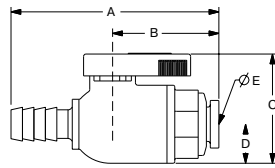

### BVC Ball Valve Clip

BV-Clip Shown below holding VUCPB and VME

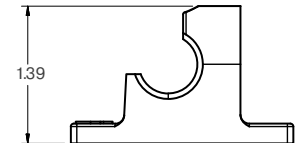
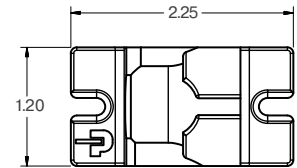

### VUCPB - Valve Union Connector Barbed x Tube

PART NO.	HOSE ID	TUBE OD	OD	A	B	C	D	ØE THRU HOLE MIN.
LFPP4VUCPB4	1/4	1/4	.31	2.40	1.08	1.42	.50	.15
LFPP6VUCPB6	3/8	3/8	.43	2.63	1.32	1.42	.50	.19

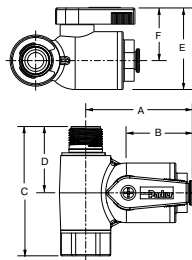

### VAS - Valve Angle Stop

PART NO.	TUBE O.D.	MALE THD.	FEMALE THD.	A	B	C	D	E	F
LFPP4VAS6	1/4	3/8	3/8	1.79	1.11	2.17	1.11	1.40	.90
LFPP4VAS8	1/4	3/8	1/2	1.79	1.11	2.40	1.11	1.40	.90
LFPP6VAS6	3/8	3/8	3/8	2.03	1.35	2.17	1.11	1.40	.90
LFPP6VAS8	3/8	3/8	1/2	2.03	1.35	2.40	1.11	1.40	.90

Do not use thread sealant. Do not over tighten.

#### VAS Assembly Instructions:

**1.** Shut off water supply at brass/chrome supply valve. Disconnect riser from brass/chrome supply valve. Ensure that the sealing gasket is fully seated into the Angle Stop Valve female thread.

**2.** Install Angle Stop Adapter Valve on supply valve. Connect the riser to the Angle Stop Adapter Valve.

**3.** Fully insert tubing into the side of the valve. Open valves and check for leaks.

**WARNING** These products can expose you to chemicals including CARBON BLACK, or LEAD, which are known to the state of California to cause cancer, and LEAD which is known to cause birth defects or other reproductive harm. For more information go to [www.P65Warnings.ca.gov](http://www.P65Warnings.ca.gov).



A  
B  
C  
D  
E  
F  
G  
H  
I  
J  
K  
L  
M  
N  
O



# TrueSeal™ Fittings

Parker's TrueSeal Fittings are lightweight, field attachable and connect to tubing without the use of tools. These all plastic push-to-connect fittings are manufactured from FDA compliant materials.

## Product Features:

- Acetal and Black Polypropylene (EPDM seals and metal gripping collet standard)
- White Polypropylene (EPDM seals and plastic gripping collet standard)
- Black Kynar (Fluorocarbon (FKM) seals and black kynar metal gripping collet standard)
- Gripping ring with stainless steel bite edge or with an engineered thermoplastic bite edge
- FDA compliant, NSF/ANSI 51
- Gray acetal and Black Polypropylene NSF/ANSI/CAN 61

## Markets:

- Food
- Potable Water
- Chemical
- Filtration

## Applications:

- Air
- Water
- Soft Drinks
- Beer
- Wine
- Dyes
- Vacuum

## Specifications:

### Pressure Range

Acetal and Kynar: 1/4", 5/16", 3/8" Vacuum to 300 PSI (20.7 bar)  
1/2" Vacuum to 250 PSI (17.2 bar)

Polypropylene: 1/4", 3/8", 1/2" Vacuum to 150 PSI (10.3 bar)

\*Vacuum rating to 28 inches of Hg at room temperature

### Temperature Range

Acetal: -20° to +180° F (-28.9° to +82.2° C)

Polypropylene: 0° to +225° F (-17.8° to +107.2° C)

Kynar: 0° to +275° F (-17.8° to +135° C)

## Compatible Tubing:

- Polyethylene
- Polypropylene\*\*
- Nylon\*\*
- Vinyl\*
- Fluoropolymer\*\*
- Polyurethane\*
- \*Kynar®

\* Registered trademark of The Arkema Group.

\*\* Metal gripper required (-MG & -HBLK suffix)

+ Tube Support required.

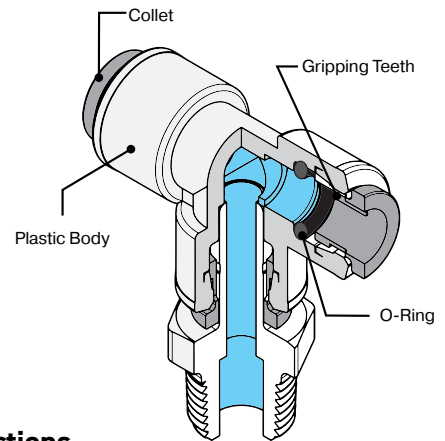

## Assembly Instructions

1. Cut tubing square and clean. (Use a Parker plastic tube cutter, Part No. PTC.)
2. Mark from end of tube length of insertion (see table below).
3. Push tube into the fitting until it bottoms out.
4. To remove, depress collet and pull tubing out.

## For Threaded Connections:

5. Inspect the mating threads for debris or damage. Remove any old fluoropolymer tape or sealant on previously used threads. If threads are damaged, replace with new adapter before proceeding.
6. Apply 1 to 2 wraps of Teflon tape to the male pipe threads, or an NSF/FDA approved silicon sealant. Do not use plumbers putty or pipe dope. These chemically react with plastic materials and could cause a failure.
7. Screw together until finger tight (approximately three turns)
8. To ensure seal continue 1 to 2 more turns past finger tight.
9. Total number of turns from start to finish need not exceed 5 turns.

TUBE SIZE	O.D. TOLERANCE	INSERTION DEPTH
1/4	±.005	11/16
5/16	±.005	13/16
3/8	±.005	3/4
1/2	±.005	7/8

**WARNING** These products can expose you to chemicals including CARBON BLACK, which is known to the state of California to cause cancer. For more information go to [www.P65Warnings.ca.gov](http://www.P65Warnings.ca.gov).



**Threaded Fittings**

**MC**

Male Connector  
NPTF  
p. C19



**FA**

Faucet Adapter  
UNS  
p. C20



**MES**

Male Elbow Swivel  
NPTF  
p. C20



**MRS**

Male Run Tee  
Swivel – NPTF  
p. C20



**MTS**

Male Branch Tee  
Swivel  
NPTF  
p. C21



**FC**

Female Connector  
NPTF  
p. C22



**TMC**

Male Standpipe  
NPTF  
p. C22



**ME**

Male Elbow  
NPTF  
p. C23



**FF**

45° Female Flare  
p. C24



**ST**

Straight Thread  
p. C24



**FE**

Female Elbow  
NPTF  
p. C25



**Tube to Tube Fittings**

**EU**

Union Elbow  
p. C19



**TU**

Union Tee  
p. C19



**UC**

Union  
p. C21



**WY**

Union Y  
p. C21



**CU**

Cross  
p. C24



**Bulkhead Union**

**BU**

Bulkhead Union  
p. C22



**Plug-In Fittings**

**TEU**

Tube Elbow Union  
p. C23



**RD**

Tube Reducer  
p. C23



**Check Valves**

**VC**

Check Valve  
p. C27



**MCVC**

Kynar Check Valve  
p. C27



**Accessories**

**TCB**

Barbed Connector  
p. C24



**TFA**

Faucet Adapter  
p. C24



**TAF**

Faucet Adapter  
p. C24



**CAP**

Cap  
p. C24



**TPL**

Plug  
p. C25



**TEB**

Barbed Connector  
p. C25



**TSC**

Cartridge  
p. C26



**SC**

Safety Clip  
p. C30



**TS**

Tube Support  
p. C30



**AQRT**

Release Tool  
p. C30



**BVC**

Ball Valve Clip  
p. C30



**Ball Valves**

**VME**

Male Elbow  
p. C28



**VFE**

Female Elbow  
p. C28



**VUC**

Union Connector  
p. C29



**VFC**

Female Connector  
p. C29



**VMC**

Male Connector  
p. C29



**VEU**

Elbow Union  
p. C30



**VTEU**

Elbow Union  
p. C30



**WARNING** These products can expose you to chemicals including CARBON BLACK, which is known to the state of California to cause cancer. For more information go to [www.P65Warnings.ca.gov](http://www.P65Warnings.ca.gov).

Click here for CADs, Product Specifications or to Configure Parts Online

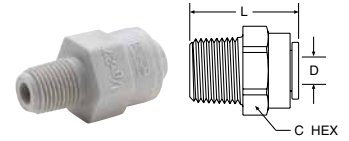

## MC - Male Connector

Tube-to-Pipe

GRAY ACETAL EPDM SEAL	BLACK PPL EPDM SEAL	WHITE PPL EPDM SEAL	BLACK KYNAR FKM SEAL	NOM TUBE O.D.	NPTF THREAD SIZE	C HEX	L OVERALL LENGTH	FLOW DIA. D
A4MC2-MG	PPB4MC2-MG	PP4MC2	FB4MC2-HBLK	1/4	1/8	11/16	1.28	.175
A4MC4-MG	PPB4MC4-MG	PP4MC4	FB4MC4-HBLK	1/4	1/4	11/16	1.14	.175
A4MC6-MG	PPB4MC6-MG	PP4MC6	FB4MC6-HBLK	1/4	3/8	11/16	1.18	.175
A5MC2-MG			FB5MC2-HBLK	5/16	1/8	13/16	1.46	.175
A5MC4-MG			FB5MC4-HBLK	5/16	1/4	13/16	1.41	.188
A5MC6-MG			FB5MC6-HBLK	5/16	3/8	13/16	1.27	.188
A6MC2-MG		PP6MC2	FB6MC2-HBLK	3/8	1/8	13/16	1.46	.175
A6MC4-MG	PPB6MC4-MG	PP6MC4	FB6MC4-HBLK	3/8	1/4	13/16	1.41	.250
A6MC6-MG	PPB6MC6-MG	PP6MC6	FB6MC6-HBLK	3/8	3/8	13/16	1.27	.250
A6MC8-MG			FB6MC8-HBLK	3/8	1/2	15/16	1.45	.250
A8MC6-MG	PPB8MC6-MG	PP8MC6	FB8MC6-HBLK	1/2	3/8	15/16	1.65	.360
A8MC8-MG	PPB8MC8-MG	PP8MC8	FB8MC8-HBLK	1/2	1/2	15/16	1.46	.375

For nonstandard plastic collet, remove -MG suffix.

## EU - Elbow Union

Tube-to-Tube

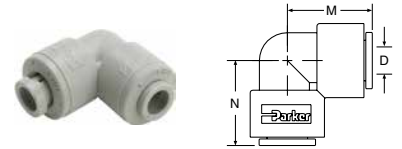

GRAY ACETAL EPDM SEAL	BLACK PPL EPDM SEAL	WHITE PPL EPDM SEAL	BLACK KYNAR FKM SEAL	NOM. TUBE O.D.	M	N	FLOW DIA. D
A4EU4-MG	PPB4EU4-MG	PP4EU4	FB4EU4-HBLK	1/4	.87	.87	.175
A5EU4-MG				5/16-1/4	1.052	.90	.175
A5EU5-MG			FB5EU5-HBLK	5/16	1.02	1.02	.188
A6EU4-MG	PPB6EU4-MG	PP6EU4	FB6EU4-HBLK	3/8-1/4	1.02	.90	.212
A6EU5-MG				3/8-5/16	1.02	1.02	.175
A6EU6-MG	PPB6EU6-MG	PP6EU6	FB6EU6-HBLK	3/8	1.02	1.02	.250
A8EU6-MG	PPB8EU6-MG			1/2-3/8	1.20	1.20	.250
A8EU8-MG	PPB8EU8-MG	PP8EU8	FB8EU8-HBLK	1/2	1.20	1.20	.375

For nonstandard plastic collet, remove -MG suffix.

## TU - Tee Union

Tube-to-Tube

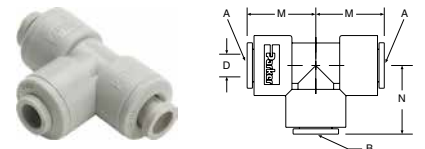

GRAY ACETAL EPDM SEAL	BLACK PPL EPDM SEAL	WHITE PPL EPDM SEAL	BLACK KYNAR FKM SEAL	NOM. TUBE O.D.		M	N	FLOW DIA. D
				TUBE A RUN	TUBE B STEM			
A4TU4-MG	PPB4TU4-MG	PP4TU4	FB4TU4-HBLK	1/4	1/4	.81	.85	.175
A5TU5-MG			FB5TU5-HBLK	5/16	5/16	1.02	1.02	.188
A6TU4-MG	PPB6TU4-MG	PP6TU4	FB6TU4-HBLK	3/8	1/4	1.02	1.03	.175
A6TU6-MG	PPB6TU6-MG	PP6TU6	FB6TU6-HBLK	3/8	3/8	1.02	1.02	.290
A8TU8-MG	PPB8TU8-MG	PP8TU8	FB8TU8-HBLK	1/2	1/2	1.20	1.20	.375

For nonstandard plastic collet, remove -MG suffix.

**WARNING** These products can expose you to chemicals including CARBON BLACK, which is known to the state of California to cause cancer. For more information go to [www.P65Warnings.ca.gov](http://www.P65Warnings.ca.gov).



Click here for CADs, Product Specifications or to Configure Parts Online

- A
- B
- C
- D
- E
- F
- G
- H
- I
- J
- K
- L
- M
- N
- O

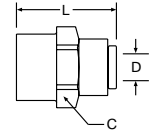

### FA - Faucet Adapter

Tube-to-Faucet

GRAY ACETAL EPDM SEAL	BLACK PPL EPDM SEAL	WHITE PPL EPDM SEAL	BLACK KYNAR FKM SEAL	NOM. TUBE O.D.	UNS-2B THREAD SIZE	C HEX	L OVERALL LENGTH	FLOW DIA. D
A4FA7-MG	PPB4FA7-MG	PP4FA7	FB4FA7-HBLK	1/4	7/16-24	23/32	1.32	.190
A5FA7-MG				5/16	7/16-24	13/16	1.41	.190
A6FA7-MG	PPB6FA7-MG	PP6FA7	FB6FA7-HBLK	3/8	7/16-24	13/16	1.41	.190

For nonstandard plastic collet, remove -MG suffix.

### MES - Male Elbow Swivel

Tube-to-Pipe

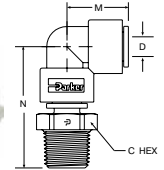

GRAY ACETAL EPDM SEAL	BLACK PPL EPDM SEAL	WHITE PPL EPDM SEAL	BLACK KYNAR FKM SEAL	NOM. TUBE O.D.	NPTF THREAD SIZE	C HEX	M	N	FLOW DIA. D
A4MES2-MG	PPB4MES2-MG	PP4MES2	FB4MES2-HBLK	1/4	1/8	9/16	.87	1.60	.175
A4MES4-MG	PPB4MES4-MG	PP4MES4	FB4MES4-HBLK	1/4	1/4	11/16	.87	1.71	.175
A4MES6-MG		PP4MES6	FB4MES6-HBLK	1/4	3/8	13/16	.90	1.91	.212
A5MES2-MG				5/16	1/8	9/16	1.02	1.78	.188
A5MES4-MG				5/16	1/4	11/16	1.02	1.90	.188
A5MES6-MG				5/16	3/8	13/16	1.02	1.90	.188
A6MES2-MG			FB6MES2-HBLK	3/8	1/8	9/16	1.02	1.65	.175
A6MES4-MG	PPB6MES4-MG	PP6MES4	FB6MES4-HBLK	3/8	1/4	13/16	1.02	1.90	.250
A6MES6-MG	PPB6MES6-MG	PP6MES6	FB6MES6-HBLK	3/8	3/8	13/16	1.02	1.90	.250
A8MES4-MG				1/2	1/4	13/16	1.20	2.10	.240
A8MES6-MG		PP8MES6		1/2	3/8	13/16	1.20	2.10	.375
A8MES8-MG		PP8MES8		1/2	1/2	1	1.20	2.32	.375

\* Part consists of elbow union and tube stem adaptor.

Note: Assemblies with metal gripper collets are permanent. Assemblies with plastic collets can be taken apart.

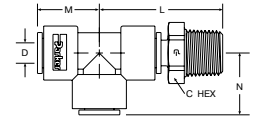

### MRS - Male Run Tee Swivel

Tube-to-Pipe

GRAY ACETAL EPDM SEAL	BLACK PPL EPDM SEAL	WHITE PPL EPDM SEAL	BLACK KYNAR FKM SEAL	NOM. TUBE O.D.	NPTF THREAD SIZE	C HEX	L	M	N	D THRU HOLE MIN.
A4MRS2-MG	PPB4MRS2	PP4MRS2	FB4MRS2-HBLK	1/4	1/8	9/16	1.55	.81	0.85	.175
A4MRS4-MG	PPB4MRS4-MG	PP4MRS4	FB4MRS4-HBLK	1/4	1/4	11/16	1.67	.81	0.85	.175
A5MRS2-MG				5/16	1/8	9/16	1.78	1.02	1.02	.188
A5MRS4-MG				5/16	1/4	11/16	1.90	1.02	1.02	.188
A5MRS6-MG				5/16	3/8	13/16	1.90	1.02	1.02	.188
A6MRS4-MG	PPB6MRS4-MG	PP6MRS4	FB6MRS4-HBLK	3/8	1/4	13/16	1.90	1.02	1.02	.250
A6MRS6-MG	PPB6MRS6-MG	PP6MRS6	FB6MRS6-HBLK	3/8	3/8	13/16	1.90	1.02	1.02	.250
A8MRS4-MG				1/2	1/4	13/16	2.10	1.20	1.20	.240
A8MRS6-MG		PP8MRS6		1/2	3/8	13/16	2.10	1.20	1.20	.375
A8MRS8-MG		PP8MRS8		1/2	1/2	1	2.32	1.20	1.20	.375

\*Part consists of tee union and tube stem adaptor.

Note: Assemblies with metal gripper collets are permanent. Assemblies with plastic collets can be taken apart.

**WARNING** These products can expose you to chemicals including CARBON BLACK, which is known to the state of California to cause cancer. For more information go to [www.P65Warnings.ca.gov](http://www.P65Warnings.ca.gov).



Click here for CADs, Product Specifications or to Configure Parts Online

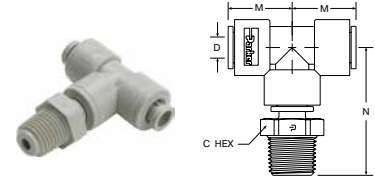

### MTS - Male Tee Swivel

Tube-to-Pipe

GRAY ACETAL EPDM SEAL	BLACK PPL EPDM SEAL	WHITE PPL EPDM SEAL	BLACK KYNAR FKM SEAL	NOM. TUBE O. D.	NPTF THREAD SIZE	C HEX	M	N	FLOW DIA. D
A4MTS2-MG	PPB4MTS2	PP4MTS2	FB4MTS2-HBLK	1/4	1/8	9/16	.81	1.60	.175
A4MTS4-MG	PPB4MTS4-MG	PP4MTS4	FB4MTS4-HBLK	1/4	1/4	11/16	.81	1.71	.175
A5MTS2-MG				5/16	1/8	9/16	1.02	1.78	.188
A5MTS4-MG				5/16	1/4	11/16	1.02	1.90	.188
A5MTS6-MG				5/16	3/8	13/16	1.02	1.90	.188
A6MTS2-MG			FB6MTS2-HBLK	3/8	1/8	9/16	1.02	1.75	.175
A6MTS4-MG	PPB6MTS4-MG	PP6MTS4	FB6MTS4-HBLK	3/8	1/4	13/16	1.02	1.90	.250
A6MTS6-MG	PPB6MTS6-MG	PP6MTS6	FB6MTS6-HBLK	3/8	3/8	13/16	1.02	1.90	.250
A8MTS4-MG				1/2	1/4	13/16	1.20	2.10	.240
A8MTS6-MG		PP8MTS6		1/2	3/8	13/16	1.20	2.10	.375
A8MTS8-MG		PP8MTS8		1/2	1/2	1	1.20	2.32	.375

\* Part consists of tee union and tube stem adaptor.

Note: Assemblies with metal gripper collets are permanent. Assemblies with plastic collets can be taken apart.



### UC - Union Connector

Tube-to-Tube

GRAY ACETAL EPDM SEAL	BLACK PPL EPDM SEAL	WHITE PPL EPDM SEAL	BLACK KYNAR FKM SEAL	NOM. TUBE O. D.	L OVERALL LENGTH	FLOW DIA. D
A4UC4-MG	PPB4UC4-MG	PP4UC4	FB4UC4-HBLK	1/4	1.49	.175
A5UC4-MG				5/16-1/4	1.70	.175
A5UC5-MG			FB5UC5-HBLK	5/16	1.70	.188
A6UC4-MG	PPB6UC4-MG	PP6UC4	FB6UC4-HBLK	3/8-1/4	1.70	.175
A6UC5-MG				3/8-5/16	1.70	.188
A6UC6-MG	PPB6UC6-MG	PP6UC6	FB6UC6-HBLK	3/8	1.70	.250
A8UC5-MG				1/2-5/16	1.90	.188
A8UC6-MG	PPB8UC6-MG	PP8UC6	FB8UC6-HBLK	1/2-3/8	1.90	.250
A8UC8-MG	PPB8UC8-MG	PP8UC8	FB8UC8-HBLK	1/2	1.91	.375

For nonstandard plastic collet, remove -MG suffix.

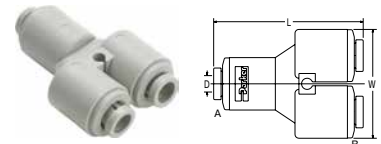

### WY - "Y" Union

Tube-to-Tube

GRAY ACETAL EPDM SEAL	WHITE PPL EPDM SEAL	BLACK KYNAR FKM SEAL	NOM. TUBE O. D.		L	W	FLOW DIA. D
			INLET TUBE A RUN	OUTLET TUBE B STEM			
		FB4W4-HBLK	1/4	1/4	2.100	1.43	.190
A5W5-MG		FB5W5-HBLK	5/16	5/16	2.250	1.75	.190
A6W4-MG		FB6W4-HBLK	3/8	1/4	2.100	1.43	.190
A6W5-MG			3/8	5/16	2.200	1.75	.190
A6W6-MG		FB6W6-HBLK	3/8	3/8	2.175	1.75	.250
		FB8W6-HBLK	1/2	3/8	2.370	1.93	.250
		FB8W8-HBLK	1/2	1/2	2.370	1.93	.380

**WARNING** These products can expose you to chemicals including CARBON BLACK, which is known to the state of California to cause cancer. For more information go to [www.P65Warnings.ca.gov](http://www.P65Warnings.ca.gov).



[Click here for CADs, Product Specifications or to Configure Parts Online](#)

- A
- B
- C
- D
- E
- F
- G
- H
- I
- J
- K
- L
- M
- N
- O

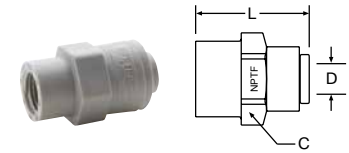

### FC - Female Connector

Tube-to-Pipe

GRAY ACETAL EPDM SEAL	BLACK PPL EPDM SEAL	WHITE PPL EPDM SEAL	BLACK KYNAR FKM SEAL	NOM. TUBE O.D.	NPTF THREAD SIZE	C HEX	L OVERALL LENGTH	FLOW DIA. D
A4FC2-MG	PPB4FC2-MG	PP4FC2	FB4FC2-HBLK	1/4	1/8	11/16	1.20	.175
A4FC4-MG	PPB4FC4-MG	PP4FC4	FB4FC4-HBLK	1/4	1/4	23/32	1.32	.175
A5FC4-MG			FB5FC4-HBLK	5/16	1/4	13/16	1.41	.188
A5FC6-MG				5/16	3/8	1	1.50	.188
A6FC4-MG	PPB6FC4-MG	PP6FC4	FB6FC4-HBLK	3/8	1/4	13/16	1.41	.250
A6FC6-MG	PPB6FC6-MG	PP6FC6	FB6FC6-HBLK	3/8	3/8	1	1.50	.250
A6FC8-MG			FB6FC8-HBLK	3/8	1/2	1-1/8	1.52	.250
A8FC6-MG		PP8FC6	FB8FC6-HBLK	1/2	3/8	1-1/8	1.60	.375
A8FC8-MG		PP8FC8	FB8FC8-HBLK	1/2	1/2	1-1/8	1.75	.375

For nonstandard plastic collet, remove -MG suffix.



### TMC - Tube Stem Adapter

Tube Stem-to-Pipe

GRAY ACETAL EPDM SEAL	BLACK PPL EPDM SEAL	WHITE PPL EPDM SEAL	BLACK KYNAR FKM SEAL	NOM. TUBE O.D.	NPTF THREAD SIZE	C HEX	L OVERALL LENGTH	FLOW DIA. D
A4TMC2	PPB4TMC2	PP4TMC2	FB4TMC2	1/4	1/8	9/16	1.44	.175
A4TMC4	PPB4TMC4	PP4TMC4	FB4TMC4	1/4	1/4	11/16	1.56	.175
A5TMC2				5/16	1/8	9/16	1.5	.188
A5TMC4			FB5TMC4	5/16	1/4	11/16	1.67	.188
A5TMC6				5/16	3/8	13/16	1.67	.188
A6TMC4	PPB6TMC4	PP6TMC4	FB6TMC4	3/8	1/4	13/16	1.70	.250
A6TMC6	PPB6TMC6	PP6TMC6	FB6TMC6	3/8	3/8	13/16	1.70	.250
A6TMC8				3/8	1/2	15/16	1.90	.250
A8TMC4				1/2	1/4	13/16	1.82	.240
A8TMC6		PP8TMC6	FB8TMC6	1/2	3/8	13/16	1.82	.375
A8TMC8		PP8TMC8	FB8TMC8	1/2	1/2	1	2.04	.375

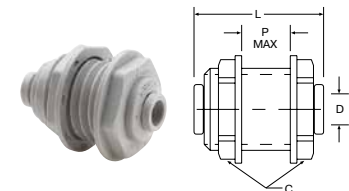

### BU - Bulkhead Union

Tube-to-Tube

GRAY ACETAL EPDM SEAL	BLACK PPL EPDM SEAL	WHITE PPL EPDM SEAL	BLACK KYNAR FKM SEAL	NOM. TUBE O.D.	C1 HEX	C2 HEX	L OVERALL LENGTH	P MAX. WALL THICKNESS	FLOW DIA. D	BKHD HOLE DRILL SIZE
A4BU4-MG	PPB4BU4-MG	PP4BU4	FB4BU4-HBLK	1/4	15/16	15/16	1.50	.50	.175	7/8
A5BU5-MG			FB5BU5-HBLK	5/16	1-1/16	1-1/16	1.75	.62	.188	1
A6BU4-MG	PPB6BU4-MG	PP6BU4	FB6BU4-HBLK	3/8-1/4	1-1/16	1-1/16	1.75	.62	.175	1
A6BU6-MG	PPB6BU6-MG	PP6BU6	FB6BU6-HBLK	3/8	1-1/16	1-1/16	1.75	.62	.250	1
A8BU8-MG			FB8BU8-HBLK	1/2	1-1/4	1-1/4	2.04	.70	.375	1-1/8

For nonstandard plastic collet, remove -MG suffix.

**WARNING** These products can expose you to chemicals including CARBON BLACK, which is known to the state of California to cause cancer. For more information go to [www.P65Warnings.ca.gov](http://www.P65Warnings.ca.gov).

Click here for CADs, Product Specifications or to Configure Parts Online

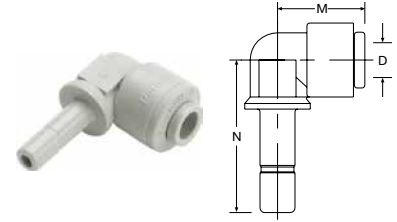

### TEU - Tube Elbow Union

Tube-to-Tube Stem

GRAY ACETAL EPDM SEAL	BLACK PPL EPDM SEAL	WHITE PPL EPDM SEAL	BLACK KYNAR FKM SEAL	NOM. TUBE O.D.	TUBE STEM O.D.	M	N	FLOW DIA. D
A4TEU4-MG	PPB4TEU4-MG	PP4TEU4	FB4TEU4-HBLK	1/4	1/4	.84	1.21	.125
A4TEU6-MG			FB4TEU6-HBLK	1/4	3/8	.84	1.35	.125
A5TEU5-MG			FB5TEU5-HBLK	5/16	5/16	1.03	1.40	.188
A6TEU4-MG			FB6TEU4-HBLK	3/8	1/4	1.03	1.29	.125
A6TEU6-MG	PPB6TEU6	PP6TEU6	FB6TEU6-HBLK	3/8	3/8	1.03	1.48	.250
A8TEU8-MG	PPB8TEU8-MG	PP8TEU8	FB8TEU8-HBLK	1/2	1/2	1.21	1.64	.380

For nonstandard plastic collet, remove -MG suffix.

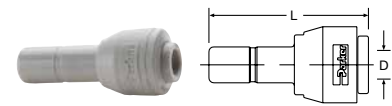

### RD - Tube Reducer

Tube-to-Tube Stem

GRAY ACETAL EPDM SEAL	BLACK PPL EPDM SEAL	WHITE PPL EPDM SEAL	BLACK KYNAR FKM SEAL	NOM. TUBE O.D.	TUBE STEM O.D.	L	FLOW DIA. D
A4RD5-MG		PP4RD5		1/4	5/16	1.62	.18
A4RD6-MG	PPB4RD6-MG	PP4RD6	FB4RD6-HBLK	1/4	3/8	1.62	.18
A5RD6-MG				5/16	3/8	1.78	.25
A5RD8-MG				5/16	1/2	1.90	.25
A6RD8-MG			FB6RD8-HBLK	3/8	1/2	1.90	.25

For nonstandard plastic collet, remove -MG suffix.

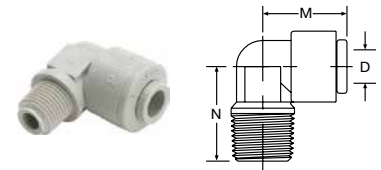

### ME - Male Elbow

Tube-to-Pipe

GRAY ACETAL EPDM SEAL	BLACK PPL EPDM SEAL	WHITE PPL EPDM SEAL	BLACK KYNAR FKM SEAL	NOM. TUBE O.D.	NPTF THREAD SIZE	M	N	FLOW DIA. D
A4ME2-MG	PPB4ME2-MG	PP4ME2	FB4ME2-HBLK	1/4	1/8	.84	.94	.175
A4ME4-MG	PPB4ME4-MG	PP4ME4	FB4ME4-HBLK	1/4	1/4	.84	.94	.175
A4ME6-MG	PPB4ME6-MG	PP4ME6	FB4ME6-HBLK	1/4	3/8	.84	1.04	.175
A5ME4-MG			FB5ME4-HBLK	5/16	1/4	1.03	1.08	.175
A5ME6-MG			FB5ME6-HBLK	5/16	3/8	1.03	1.06	.188
A6ME4-MG		PP6ME4	FB6ME4-HBLK	3/8	1/4	1.03	1.08	.250
A6ME6-MG	PPB6ME6-MG	PP6ME6	FB6ME6-HBLK	3/8	3/8	1.03	1.06	.250

For nonstandard plastic collet, remove -MG suffix.

**WARNING** These products can expose you to chemicals including CARBON BLACK, which is known to the state of California to cause cancer. For more information go to [www.P65Warnings.ca.gov](http://www.P65Warnings.ca.gov).



Click here for CADs, Product Specifications or to Configure Parts Online

- A
- B
- C
- D
- E
- F
- G
- H
- I
- J
- K
- L
- M
- N
- O



### TCB - Tube-to-Barb Connector

GRAY ACETAL	BLACK PPL EPDM SEAL	WHITE POLYPROPYLENE	BLACK KYNAR FKM SEAL	TUBE STEM O.D.	TUBE I.D.	L OVERALL LENGTH	FLOW DIA. D
A4TCB4	PPB4TCB4	PP4TCB4	FB4TCB4	1/4	1/4	1.67	.140
A6TCB4			FB6TCB4	3/8	1/4	1.82	.140
A6TCB6	PPB6TCB6	PP6TCB6	FB6TCB6	3/8	3/8	1.98	.250
A8TCB6				1/2	3/8	2.10	.250
A8TCB8			FB8TCB8	1/2	1/2	2.10	.375

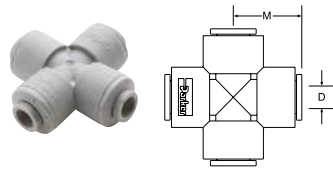

### CU - Cross Union

Tube-to-Tube

GRAY ACETAL EPDM SEAL	WHITE PPL EPDM SEAL	BLACK KYNAR FCB SEAL	NOM. TUBE O.D.	M	FLOW DIA. D
A4CU4-MG			1/4	.91	.175
A6CU6-MG		FB6CU6-HBLK	3/8	1.08	.250

For nonstandard plastic collet, remove -MG suffix.

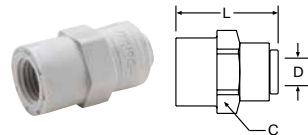

### FF - 45° Female Flare

Tube-to-Flare

GRAY ACETAL EPDM SEAL	WHITE PPL EPDM SEAL	BLACK KYNAR FKM SEAL	NOM. TUBE O.D.	UNF-2B THREAD SIZE	C HEX	L OVERALL LENGTH	FLOW DIA. D
A4FF4-MG	PP4FF4	FB4FF4-HBLK	1/4	7/16-20	23/32	1.32	.190
A6FF4-MG		FB6FF4-HBLK	3/8	7/16-20	13/16	1.41	.190
A6FF6-MG	PP6FF6	FB6FF6-HBLK	3/8	5/8-18	1	1.50	.250

For nonstandard plastic collet, remove -MG suffix.

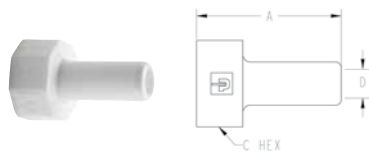

### TFA - Tube Faucet Adapter

(Female Thread)

WHITE ACETAL	TUBE STEM O.D.	THREAD SIZE	A	C HEX	D MIN.
AW6TFA7-MG	3/8	7/16-24	1.25	.69	.17
AW6TFA8-MG	3/8	1/2-14 NPSM	1.45	1.06	.22
AW6TFA9-MG	3/8	9/16-24	1.25	.75	.22

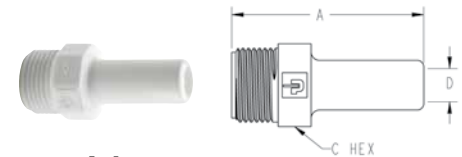

### TAF - Tube Faucet Adapter

(Male Thread)

WHITE ACETAL	TUBE STEM O.D.	THREAD SIZE	A	C HEX	D MIN.
AW6TAF7-MG	3/8	7/16-24	1.41	.50	.22
AW6TAF8-MG	3/8	1/2-14 NPSM	1.65	.88	.22
AW6TAF9-MG	3/8	9/16-24	1.45	.63	.22

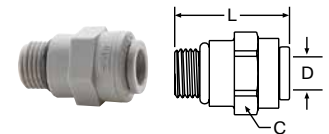

### ST - Straight Thread

Tube-to-Male O-Ring Boss

GRAY ACETAL EPDM SEAL	WHITE PPL EPDM SEAL	BLACK KYNAR FKM SEAL	NOM. TUBE O.D.	UNF-2B THD SIZE	C HEX	L OVERALL LENGTH	FLOW DIA. D
A6ST9-MG		FB6ST9-HBLK	3/8	9/16-18	13/16	1.39	.250

For nonstandard plastic collet, remove -MG suffix.



### CAP - Tube Cap

GRAY ACETAL EPDM SEAL	WHITE PPL EPDM SEAL	NATURAL KYNAR FKM SEAL	NOM. TUBE O.D.	L OVERALL LENGTH
A4CAP-MG	PP4CAP	FB4CAP-HBLK	1/4	.77
A6CAP-MG	PP6CAP		3/8	0.88

For nonstandard plastic collet, remove -MG suffix.

**WARNING** These products can expose you to chemicals including CARBON BLACK, which is known to the state of California to cause cancer. For more information go to [www.P65Warnings.ca.gov](http://www.P65Warnings.ca.gov).





Click here for CADs, Product Specifications or to Configure Parts Online

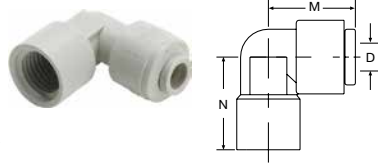

### FE - Female Elbow

Tube-to-Pipe

GRAY ACETAL EPDM SEAL	WHITE PPL EPDM SEAL	BLACK KYNAR FKM SEAL	NOM. TUBE O.D.	NPTF THREAD SIZE	M	N	FLOW DIA. D
A4FE4-MG		FB4FE4-HBLK	1/4	1/4	.84	1.00	.18
A6FE4-MG		FB6FE4-HBLK	3/8	1/4	1.03	1.00	.25
A6FE6-MG		FB6FE6-HBLK	3/8	3/8	1.03	1.00	.25

For nonstandard plastic collet, remove -MG suffix.

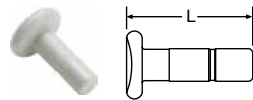

### TPL - Plug

GRAY ACETAL	BLACK PPL	WHITE PPL	BLACK KYNAR	FITTING SIZE	L OVERALL LENGTH
A4TPL	PPB4TPL	PP4TPL	FB4TPL	1/4	0.88
A6TPL	PPB6TPL	PP6TPL	FB6TPL	3/8	1.45
A8TPL	PPB8TPL	PP8TPL	FB8TPL	1/2	1.50



### TEB - Tube Elbow Barb Connector

GRAY ACETAL	WHITE POLYPROPYLENE	BLACK KYNAR	TUBE STEM O.D.	TUBE I.D.	M	N	FLOW DIA. D
A4TEB4	PP4TEB4	FB4TEB4	1/4	1/4	.89	1.00	.140
A6TEB4	PP6TEB4	FB6TEB4	3/8	1/4	1.335	1.055	.375
A6TEB6	PP6TEB6	FB6TEB6	3/8	3/8	1.34	1.21	.250
A8TEB8		FB8TEB8	1/2	1/2	1.30	1.30	.390

**WARNING** These products can expose you to chemicals including CARBON BLACK, which is known to the state of California to cause cancer. For more information go to [www.P65Warnings.ca.gov](http://www.P65Warnings.ca.gov).



- A
- B
- C
- D
- E
- F
- G
- H
- I
- J
- K
- L
- M
- N
- O

Click here for CADs, Product Specifications or to Configure Parts Online



### TSC - Cartridge Insert

PART NO. WITH EPDM SEAL	NOM. TUBE O.D.	A* DIAMETER ±002	B DIAMETER ±003	C DIAMETER ±003	D DIAMETER MAXIMUM	E DEPTH ±002	F DEPTH ±002	G DEPTH ±002	H* CENTERLINE OF PORTS MINIMUM
ATSC4-MG	1/4	.528	.421	.260	.19	.230	.435	.600	.670
ATSC6-MG	3/8	.632	.545	.385	.31	.280	.455	.705	.790
ATSC8-MG	1/2	.774	.668	.510	.41	.315	.510	.810	1.250

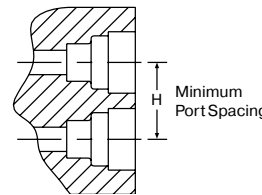
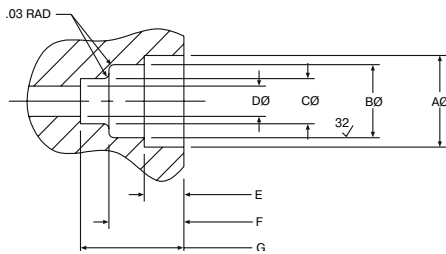

#### Parker TrueSeal™ Cartridge Inserts:

Allow you to machine or mold a tube connection into your equipment or components. By using cartridge inserts, you will reduce your material and assembly costs, reduce potential leak paths, and give your equipment a new, clean profile by eliminating the need for threaded connections. TSC Cartridge Inserts consist of 1 o-ring, 1 cartridge, and 1 collet.

\*Cartridge inserts are rated at 150 PSI in ports dimensioned as above and having Noryl as the receiving material. Other materials may have different ratings and require different port dimensions. Consult the Fluid System Connectors Division when using polypropylene, unfilled polypropylene, ABS or Nylon.

NORYL® is a registered trademark of the General Electric Co.

#### Assembly Instructions:

1. Machine or mold the receiving orifice as per the above dimensions.
2. Place the cartridge insert squarely onto the prepared port opening making sure that the barbs of the cartridge are going into the hole and the lettering on the face of the cartridge is visible.
3. Using a rubber mallet or press, insert the cartridge into the first gland orifice until its face is flush with the top surface of the port.
4. Insert the o-ring into the cartridge and seat it evenly into the second gland orifice.
5. Insert the collet into the cartridge opening.
6. Insert tubing.

**WARNING** These products can expose you to chemicals including CARBON BLACK, which is known to the state of California to cause cancer. For more information go to [www.P65Warnings.ca.gov](http://www.P65Warnings.ca.gov).



Click here for CADs, Product Specifications or to Configure Parts Online

### TrueSeal Check Valves

Push-to-Connect check valves that ensures protection against reversal of flow. The valves have an arrow molded into the body to indicate the direction of flow. Valves are designed for connection with either thermoplastic or soft metal tubing and are intended for use with liquids only.

#### Materials of Construction

<b>Body</b>	Acetal
<b>O-ring</b>	EPDM
<b>Metal Grip Edge</b>	300 Stainless
<b>Working Pressure</b>	Up to 150 PSI (10.3 bar) depending on tubing being used
<b>Temperature Range</b>	+34° to +150° F (+1° to +65° C)
<b>Cracking Pressure</b>	1/3 PSI (0.02 bar)

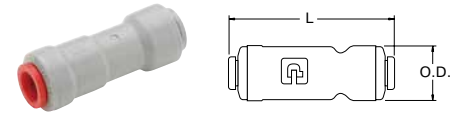

### VC – Check Valve

PART NO.	TUBE SIZE	L	O.D.
A4VC4-MG	1/4	2.00	.66
A5VC5-MG	5/16	2.10	.70
A6VC6-MG	3/8	2.15	.80
A8VC8-MG	1/2	2.68	.91

### PVDF Check Valves

#### Materials of Construction

<b>Body</b>	Kynar®
<b>O-ring</b>	Fluorocarbon
<b>Metal Grip Edge</b>	Stainless Steel
<b>Working Pressure</b>	Up to 300 PSI (20.7 bar)
<b>Temperature Range</b>	0° to +250° F (-17.8° to +121° C)

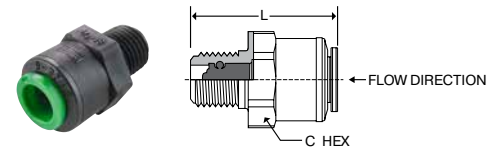

### MCVC Kynar® Check Valves

PART NO.	TUBE O.D.	NPTF THREAD	L	C HEX	CRACKING PRESSURE PSI
FB6MCVC4-HBLK-05	3/8	1/4	1.40	13/16	.5

Note: For check valve to function properly tubing needs to be installed

**WARNING** These products can expose you to chemicals including CARBON BLACK, which is known to the state of California to cause cancer. For more information go to [www.P65Warnings.ca.gov](http://www.P65Warnings.ca.gov).



Click here for CADs, Product Specifications or to Configure Parts Online

- A
- B
- C
- D
- E
- F
- G
- H
- I
- J
- K
- L
- M
- N
- O

## Polypropylene Ball Valves

For proven leak-free performance, specify Polypropylene Ball Valves. Their corrosion-resistant, all-plastic design makes them ideal for water filtration units, coffee and beverage machines and a wide variety of other fluid applications. Polypropylene material meets all FDA and NSF-51 requirements for food contact.

### Features/Benefits:

- Precision molded, all-plastic design is leak free and corrosion resistant.
- Polypropylene material offers a wider chemical acceptance range, as well as a wide temperature range.
- Bi-directional flow maximizes productivity.
- Full flow design reduces pressure drop across the valve.
- Special o-ring seal ensures a reliable leak-tight connection.
- TrueSeal™ connection reduces potential leaks.

### Specifications:

- Temperature range: +35° to +200°F (+2° to +93°C)
- O-ring seal material: EPDM
- NSF/ANSI 51 and NSF/ANSI/CAN 61
- Pressure rated to 150 PSI (10.3 bar). Actual working pressures with be lower at elevated temperatures

### Advantages:

- Reduce costs—Built-in TrueSeal™ connection eliminates the need for a secondary fitting.
- Save space—Low-profile design allows for easy assembly and access where space is at a premium.

## VME - Valve Male Elbow

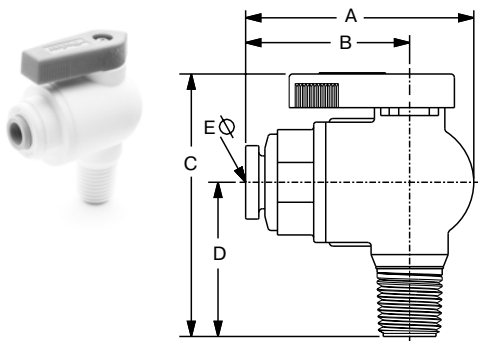

PART NUMBER	NOM. TUBE O.D.	NPTF THREAD SIZE	A	B	C	D	ØE THRU HOLE MIN.
PP4VME2-MG (+)	1/4	1/8	1.74	1.21	2.00	1.10	.19
PP4VME4-MG	1/4	1/4	1.74	1.21	2.18	1.28	.19
PP4VME6-MG	1/4	3/8	1.74	1.21	2.18	1.28	.19
PP4VME8-MG (+)	1/4	1/2	1.74	1.21	2.37	1.47	.19
PP6VME2-MG (+)	3/8	1/8	1.85	1.32	2.00	1.10	.25
PP6VME4-MG	3/8	1/4	1.85	1.32	2.18	1.28	.25
PP6VME6-MG	3/8	3/8	1.85	1.32	2.18	1.28	.25
PP6VME8-MG	3/8	1/2	1.85	1.32	2.37	1.47	.25

## VFE - Valve Female Elbow

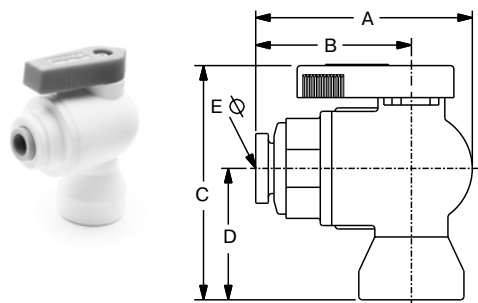

PART NUMBER	NOM. TUBE O.D.	NPTF THREAD SIZE	A	B	C	D	ØE THRU HOLE MIN.
PP4VFE2-MG (+)	1/4	1/8	1.74	1.21	1.82	.92	.19
PP4VFE4-MG	1/4	1/4	1.74	1.21	2.05	1.15	.19
PP4VFE6-MG	1/4	3/8	1.74	1.21	2.18	1.28	.19
PP6VFE2-MG (+)	3/8	1/8	1.85	1.32	1.82	.92	.25
PP6VFE4-MG	3/8	1/4	1.85	1.32	2.05	1.15	.25
PP6VFE6-MG	3/8	3/8	1.85	1.32	2.18	1.28	.25

(+) Non Standard.

**WARNING** These products can expose you to chemicals including CARBON BLACK, which is known to the state of California to cause cancer. For more information go to [www.P65Warnings.ca.gov](http://www.P65Warnings.ca.gov).



Click here for CADs, Product Specifications or to Configure Parts Online

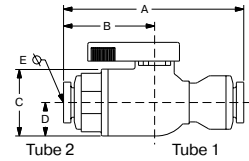

### VUC - Valve Union Connector

BLACK POLYPROPYLENE	WHITE POLYPROPYLENE	1 TUBE SIZE	2 TUBE SIZE	A	B	C	D	Ø THRU HOLE MIN.
PPB4VUC4-MG	PP4VUC4-MG	1/4	1/4	2.55	1.22	1.0	.5	.19
	PP4VUC6-MG	1/4	3/8	2.55	1.22	1.0	.5	.19
	PP6VUC4-MG	3/8	1/4	2.57	1.30	1.0	.5	.19
PPB6VUC6-MG	PP6VUC6-MG	3/8	3/8	2.67	1.32	1.4	.5	.25
	PP8VUC8-MG	1/2	1/2	2.94	1.55	1	.5	.38

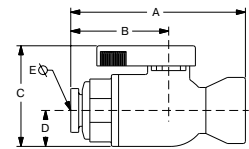

### VFC - Valve Female Connector

BLACK POLYPROPYLENE	WHITE POLYPROPYLENE	NOM. TUBE O.D.	NPTF THREAD SIZE	A	B	C	D	Ø THRU HOLE MIN.
	PP4VFC2-MG	1/4	1/8	2.04	1.21	1.4	.5	.19
	PP4VFC4-MG	1/4	1/4	2.27	1.21	1.4	.5	.19
	PP4VFC6-MG	1/4	3/8	2.40	1.21	1.4	.5	.19
	PP6VFC2-MG	3/8	1/8	2.15	1.32	1.4	.5	.25
PPB6VFC4-MG	PP6VFC4-MG	3/8	1/4	2.38	1.32	1.4	.5	.25
PPB6VFC6-MG	PP6VFC6-MG	3/8	3/8	2.51	1.32	1.4	.5	.25

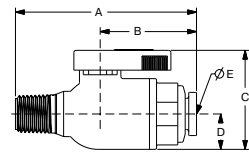

### VMC - Valve Male Connector

BLACK POLYPROPYLENE	WHITE POLYPROPYLENE	NOM. TUBE O.D.	NPTF THREAD SIZE	A	B	C	D	Ø THRU HOLE MIN.
	PP4VMC2-MG (+)	1/4	1/8	2.22	1.21	1.4	.5	.19
PPB4VMC4-MG	PP4VMC4-MG	1/4	1/4	2.40	1.21	1.4	.5	.19
	PP4VMC6-MG	1/4	3/8	2.40	1.21	1.4	.5	.19
	PP4VMC8-MG (+)	1/4	1/2	2.59	1.21	1.4	.5	.19
	PP6VMC2-MG (+)	3/8	1/8	2.33	1.32	1.4	.5	.25
	PP6VMC4-MG	3/8	1/4	2.51	1.32	1.4	.5	.25
	PP6VMC6-MG	3/8	3/8	2.51	1.32	1.4	.5	.25
	PP6VMC8-MG (+)	3/8	1/2	2.70	1.32	1.4	.5	.25

**WARNING** These products can expose you to chemicals including CARBON BLACK, which is known to the state of California to cause cancer. For more information go to [www.P65Warnings.ca.gov](http://www.P65Warnings.ca.gov).



- A
- B
- C
- D
- E
- F
- G
- H
- I
- J
- K
- L
- M
- N
- O

Click here for CADs, Product Specifications or to Configure Parts Online

- A
- B
- C
- D
- E
- F
- G
- H
- I
- J
- K
- L
- M
- N
- O

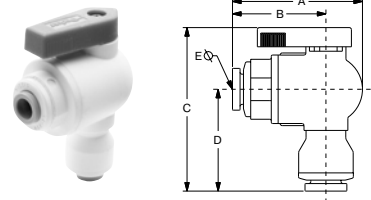

**VEU - Valve Elbow Union**

BLACK POLYPROPYLENE	WHITE POLYPROPYLENE	1 TUBE SIZE	2 TUBE SIZE	A	B	C	D	ØE THRU HOLE MIN.
	PP4VEU4-MG	1/4	1/4	1.75	1.22	2.33	1.42	.19
	PP4VEU6-MG	1/4	3/8	1.75	1.22	2.33	1.42	.11
	PP6VEU4-MG	3/8	1/4	1.83	1.30	2.32	1.40	.19
PPB6VEU6-MG	PP6VEU6-MG	3/8	3/8	1.85	1.32	2.34	1.44	.25
	PP8VEU8-MG	1/2	1/2	1.93	1.39	2.51	1.61	0.38

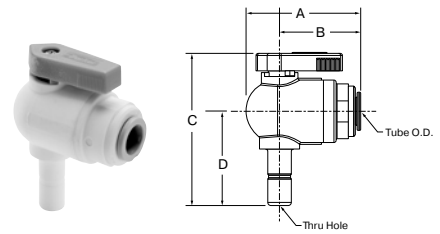

**VTEU - Valve Tube Elbow Union**

BLACK POLYPROPYLENE	WHITE POLYPROPYLENE	NOM. TUBE O.D.	STEM	A	B	C	D	ØE THRU HOLE MIN.
PPB6VTEU6-MG	PP4VTEU6-MG	1/4	3/8	1.75	1.22	2.43	1.50	.17
	PP6VTEU6-MG	3/8	3/8	1.83	1.30	2.43	1.50	.25



**SC - Safety Clip**

(Patent No. 6,065,779)

PART NUMBER	PART NUMBER	FOR NOMINAL TUBE O.D.
SC-4	SC-4-B	1/4
SC-5	SC-5-B	5/16
SC-6	SC-6-B	3/8
SC-8	SC-8-B	1/2

**AQRT - Quick Release Tool**

Makes disconnection of tube adapters and tubing a breeze.



**BVC Ball Valve Clip**

BV-Clip Shown below holding VUCPB and VME

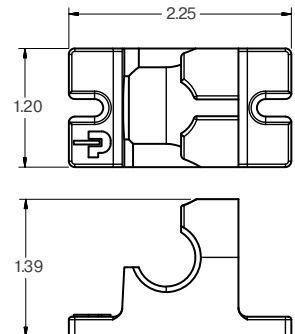

**TS - Tube Supports**

NYLON PART NO.	PPL PART NUMBER
N4TS3	P4TS3
N5TS3	P5TS3
N6TS4	P6TS4
N8TS6	P8TS6

To be used with soft durometer tubing.

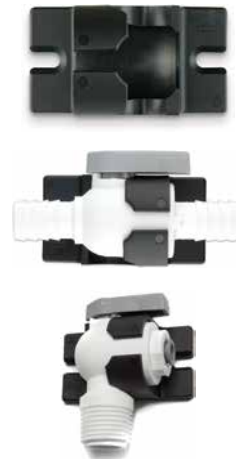

**WARNING** These products can expose you to chemicals including CARBON BLACK, which is known to the state of California to cause cancer. For more information go to [www.P65Warnings.ca.gov](http://www.P65Warnings.ca.gov).



A  
B  
C  
D  
E  
F  
G  
H  
I  
J  
K  
L  
M  
N  
O

# Fast & Tite® Fittings



Parker's Fast & Tite Fittings are a compression style fitting that installs in seconds without tools and provides a tight, sure, leak proof seal without clamps or adjustments. A unique grab ring for tube retention, coupled with a Nitrile o-ring creates a positive seal and assures good tube retention with only hand tight assembly.

## Product Features:

- Available in black polypropylene and white nylon
- White polypropylene available as a non-standard part
- 302 stainless steel grab ring
- Nitrile O-ring
- FDA compliant material
- NSF/ANSI-51

## Markets:

- Water Filtration
- Beverage Dispensing
- Life Science
- Bottling
- Semi-Conductor

## Applications:

- Water
- Beverages
- Food
- Cooling Systems
- Vacuum

## Compatible Tubing:

- Thermoplastic
- Soft Metal
- Glass

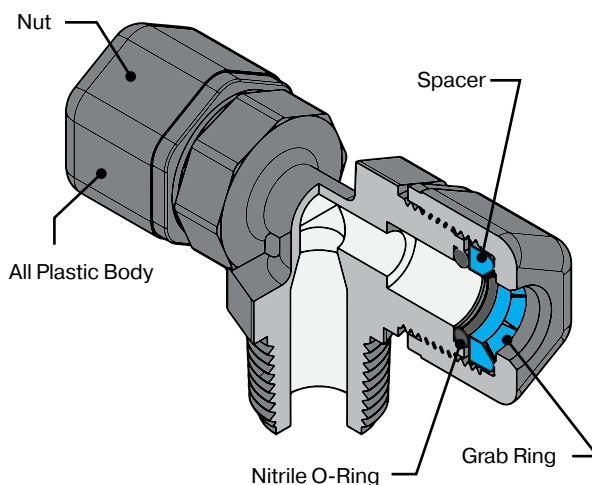

## Specifications:

### Air-Oil-Water Pressure in PSI (bar)

TUBE O. D. IN.	UP TO 75° F	76° TO 125° F	126° TO 175° F
1/4	300 (20.7)	300 (20.7)	300 (20.7)
5/16	300 (20.7)	300 (20.7)	300 (20.7)
3/8	250 (17.2)	250 (17.2)	150 (10.3)
1/2	200 (13.8)	200 (13.8)	150 (10.3)
5/8	150 (10.3)	100 (6.9)	50 (3.5)

## Temperature Range

Nylon: -40° to +200° F (-40° to +93.3° C)

Polypropylene: 0° to +212° F (-17.8° to +100° C)

TUBE O.D. (IN.)	INSERTION LENGTH
1/4	5/8
5/16	5/8
3/8	13/16
1/2	7/8
5/8	1

## Assembly Instructions

1. Cut the tube squarely and remove any burrs.
2. Mark from end of tube the length of insertion. If using a tube support, insert fully into tube before marking. (See insertion length table left)
3. Loosen nut on fitting until three threads are visible. Fittings for glass tubes must be disassembled and the grab ring removed. If the fitting has been disassembled the components are to be placed in the following order: fitting body, o-ring, spacer, grab ring and nut. Assemble the nut until three threads are showing on the body before inserting tube.
4. Moisten end of the tube with water. Push the tube Straight into fitting until it bottoms on the fitting's shoulder. Tighten nut by hand. Additional tightening should not be necessary, but 1/4 additional turn may be added if desired. Do not overtighten nut as the threads will strip and the fitting will not function properly. A proper assembly will not show the insertion mark extending beyond the nut. If the insertion mark is visible, then steps 1 thru 4 must be repeated.
5. Whenever a Fast & Tite® fitting is assembled for service or reuse the stainless steel grab ring should be replaced for maximum tubing retention.

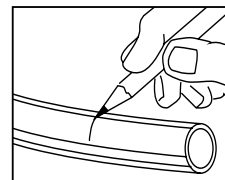
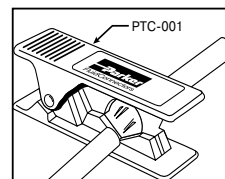

Note: Provide adequate fail-safe mechanisms such as leakage detection sensors, automatic shut-off controls or other industry and code appropriate fail-safe devices in the design of your water-handling appliance to protect against personal injury and property damage. Plastic fittings containing an o-ring have a finite life depending on the environment, media and severity of the application. Frequent inspections and replacement of the fitting when anomalies are found is recommended.

**WARNING** These products can expose you to chemicals including CARBON BLACK, which is known to the state of California to cause cancer. For more information go to [www.P65Warnings.ca.gov](http://www.P65Warnings.ca.gov).



**Threaded Fittings**

**MC**

Male Connector  
NPTF  
p. C33



**ME**

Male Elbow  
NPTF  
p. C33



**FE**

Female Elbow  
NPTF  
p. C34



**FC**

Female Connector  
NPTF  
p. C34



**MR**

Male Run Tee  
NPTF  
p. C34



**MT**

Male Branch Tee  
NPTF  
p. C34



**Tube to Tube Fittings**

**UC**

Union  
p. C33



**EU**

Union Elbow  
p. C33



**TU**

Union Tee  
p. C34



**Bulkhead Unions**

**BU**

Bulkhead Union  
p. C34



**Accessories**

**GR**

Grab Ring  
p. C35



**NS**

Nut & Spacer  
p. C35



**TS**

Tube Support  
p. C35



**OR**

O-Ring  
p. C35



**Ball Valves**

**VUC**

Valve Union  
Connector  
p. C36



**VMC**

Valve Male  
Connector  
p. C36



**VFC**

Valve Female  
Connector  
p. C36



**VFE**

Valve Female  
Elbow  
p. C37



**VME**

Valve Male Elbow  
p. C37



**VEU**

Valve Elbow Union  
p. C37



**WARNING** These products can expose you to chemicals including CARBON BLACK, which is known to the state of California to cause cancer. For more information go to [www.P65Warnings.ca.gov](http://www.P65Warnings.ca.gov).



Click here for CADs, Product Specifications or to Configure Parts Online

### MC - Male Connector



Tube to male pipe

WHITE PPL PART NO.	BLACK PPL PART NO.	WHITE NYLON PART NO.	NOM TUBE O.D.	NPTF THREAD SIZE	C HEX	L OVERALL LENGTH	FLOW DIA. D
	P4MC2	N4MC2	1/4	1/8	11/16	1.28	.170
W4MC4*	P4MC4	N4MC4	1/4	1/4	11/16	1.51	.170
W4MC6*	P4MC6*	N4MC6*	1/4	3/8	11/16	.148	.170
W5MC2*	P5MC2	N5MC2	5/16	1/8	11/16	1.38	.170
	P5MC4	N5MC4	5/16	1/4	11/16	1.50	.250
	P6MC2	N6MC2	3/8	1/8	13/16	1.50	.170
W6MC4*	P6MC4	N6MC4	3/8	1/4	13/16	1.67	.250
W6MC6*	P6MC6	N6MC6	3/8	3/8	13/16	1.67	.250
W6MC8*	P6MC8	N6MC8	3/8	1/2	1	1.78	.250
W6MC12*	P6MC12	N6MC12	3/8	3/4	1	1.84	.250
W8MC2*	P8MC2	N8MC2	1/2	1/8	1	1.61	.170
W8MC4*	P8MC4	N8MC4	1/2	1/4	1	1.74	.250
W8MC6*	P8MC6	N8MC6	1/2	3/8	1	1.74	.375
W8MC8*	P8MC8	N8MC8	1/2	1/2	1	1.87	.375
W8MC12*	P8MC12	N8MC12	1/2	3/4	1	1.89	.375
W10MC2*	P10MC2		5/8	1/8	1-1/8	1.75	.170
W10MC4*	P10MC4	N10MC4	5/8	1/4	1-1/8	1.90	.250
	P10MC6	N10MC6	5/8	3/8	1-1/8	1.90	.375
W10MC8*	P10MC8	N10MC8	5/8	1/2	1-1/8	2.01	.500
W10MC12*	P10MC12	N10MC12	5/8	3/4	1-1/8	2.04	.500

\*Non-standard part, contact division for price and availability.

### UC - Union Connector

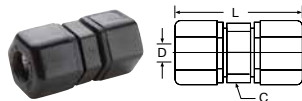

Tube to tube

WHITE PPL PART NO.	BLACK PPL PART NO.	WHITE NYLON PART NO.	NOM. TUBE O.D.	C HEX	L OVERALL LENGTH	FLOW DIA. D
W4UC4*	P4UC4	N4UC4	1/4	11/16	1.62	.170
W5UC4*	P5UC4	N5UC4	5/16-1/4	11/16	1.62	.170
	P5UC5	N5UC5	5/16	11/16	1.62	.190
	P6UC4	N6UC4	3/8-1/4	13/16	1.80	.170
	P6UC5	N6UC5	3/8-5/16	13/16	1.80	.190
W6UC6*	P6UC6	N6UC6	3/8	13/16	1.92	.250
W8UC6*	P8UC6	N8UC6	1/2-3/8	1	1.95	.250
W8UC8*	P8UC8	N8UC8	1/2	1	2.03	.375
W10UC6*	P10UC6	N10UC6	5/8-3/8	1-1/8	2.19	.250
W10UC8*	P10UC8	N10UC8	5/8-1/2	1-1/8	2.24	.375
	P10UC10	N10UC10	5/8	1-1/8	2.40	.500

\*Non-standard part, contact division for price and availability.

### ME - Male Elbow

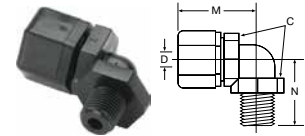

Tube to male pipe

WHITE PPL PART NO.	BLACK PPL PART NO.	WHITE NYLON PART NO.	NOM TUBE O.D.	NPTF THD SIZE	C HEX	M	N	FLOW DIA. D
	P4ME2	N4ME2	1/4	1/8	3/4	1.06	0.81	.170
W4ME4*	P4ME4	N4ME4	1/4	1/4	3/4	1.06	1.02	.170
W4ME6*	P4ME6	N4ME6	1/4	3/8	3/4	1.06	1.02	.170
W5ME2*	P5ME2		5/16	1/8	3/4	1.06	0.81	.193
W5ME4*	P5ME4	N5ME4	5/16	1/4	3/4	1.06	1.02	.193
W5ME6*	P5ME6		5/16	3/8	3/4	1.06	1.02	.193
W6ME4*	P6ME4	N6ME4	3/8	1/4	7/8	1.28	1.12	.250
W6ME6*	P6ME6	N6ME6	3/8	3/8	7/8	1.28	1.12	.250
W6ME8*	P6ME8	N6ME8	3/8	1/2	1	1.28	1.34	.250
W6ME12*	P6ME12	N6ME12	3/8	3/4	1-3/16	1.59	1.40	.250
W8ME4*	P8ME4	N8ME4*	1/2	1/4	1-1/16	1.48	1.22	.250
W8ME6*	P8ME6	N8ME6	1/2	3/8	1-1/16	1.56	1.21	.375
W8ME8*	P8ME8	N8ME8	1/2	1/2	1-1/16	1.56	1.34	.375
W8ME12*	P8ME12*	N8ME12*	1/2	3/4	1-1/8	1.50	1.40	.375
	P10ME8	N10ME8	5/8	1/2	1-3/16	1.72	1.40	.500

\*Non-standard part, contact division for price and availability.

### EU - Elbow Union

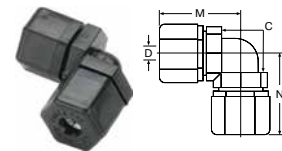

Tube to tube

WHITE PPL PART NO.	BLACK PPL PART NO.	WHITE NYLON PART NO.	NOM. TUBE O.D.	C HEX	M	N	FLOW DIA. D
W4EU4*	P4EU4	N4EU4	1/4	3/4	1.06	1.06	.170
W5EU4*	P5EU4	N5EU4	5/16-1/4	3/4	1.06	1.06	.170
W5EU5*	P5EU5	N5EU5	5/16	3/4	1.06	1.06	.193
	P6EU4	N6EU4	3/8-1/4	7/8	1.06	1.28	.170
W6EU5*	P6EU5		3/8-5/16	7/8	1.06	1.28	.170
W6EU6*	P6EU6	N6EU6	3/8	7/8	1.28	1.28	.250
	P8EU6	N8EU6	1/2-3/8	1-1/16	1.37	1.56	.250
W8EU8*	P8EU8	N8EU8	1/2	1-1/16	1.56	1.56	.375
	P10EU10	N10EU10	5/8	1-3/16	1.72	1.72	.500

\*Non-standard part, contact division for price and availability.

\* Non-standard

**WARNING** These products can expose you to chemicals including CARBON BLACK, which is known to the state of California to cause cancer. For more information go to [www.P65Warnings.ca.gov](http://www.P65Warnings.ca.gov).



- A
- B
- C
- D
- E
- F
- G
- H
- I
- J
- K
- L
- M
- N
- O

Click here for CADs, Product Specifications or to Configure Parts Online

- A
- B
- C
- D
- E
- F
- G
- H
- I
- J
- K
- L
- M
- N
- O

### BU - Bulkhead Union



Tube to tube

WHITE PPL PART NO.	BLACK PPL PART NO.	WHITE NYLON PART NO.	NOM TUBE O.D.	A REF.	C HEX	L OVERALL LENGTH	P MAX	FLOW DIA. D	BLKHD HOLE DRILL SIZE
W4BU4*	P4BU4	N4BU4	1/4	1/4	13/16	2-11/64	3/8	.170	21/32
W5BU5*	P5BU5	N5BU5	5/16	1/4	13/16	2-11/64	3/8	.187	21/32
W6BU6*	P6BU6	N6BU6	3/8	9/32	15/16	2-39/64	1/2	.250	25/32
W8BU8*	P8BU8	N8BU8	1/2	5/16	1-5/32	2-3/4	1/2	.375	31/32

\*Non-standard part, contact division for price and availability.

### MR - Male Run Tee

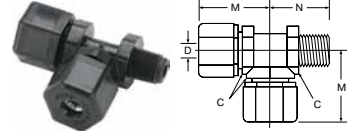

Tube to male pipe

WHITE PPL PART NO.	BLACK PPL PART NO.	WHITE NYLON PART NO.	NOM TUBE O.D.	NPTF THD SIZE	C HEX	M	N	FLOW DIA. D
	P4MR2	N4MR2	1/4	1/8	11/16	1.09	0.89	.170
W6MR4*	P6MR4	N6MR4	3/8	1/4	13/16	1.30	1.17	.250
	P8MR6		1/2	3/8	1	1.46	1.28	.375
W10MR8*			5/8	1/2	1-1/8	1.68	1.50	.500

\*Non-standard part, contact division for price and availability.

### FE - Female Elbow

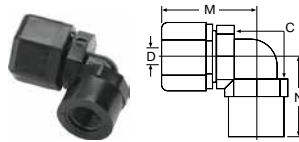

Tube to female pipe

WHITE PPL PART NO.	BLACK PPL PART NO.	WHITE NYLON PART NO.	NOM TUBE O.D.	NPTF THD SIZE	C HEX	M	N	FLOW DIA. D
	P4FE2	N4FE2	1/4	1/8	11/16	1.10	0.84	.170
W4FE4*	P4FE4	N4FE4	1/4	1/4	11/16	1.10	0.94	.170
W5FE2*		N5FE2	5/16	1/8	11/16	1.10	0.84	.193
W6FE4*	P6FE4	N6FE4	3/8	1/4	13/16	1.30	1.06	.250
	P6FE6	N6FE6	3/8	3/8	13/16	1.30	1.03	.250
W8FE6*	P8FE6	N8FE6	1/2	3/8	1	1.50	1.16	.375
W8FE8*	P8FE8	N8FE8	1/2	1/2	1	1.50	1.27	.375
W10FE8*	P10FE8	N10FE8	5/8	1/2	1-1/8	1.70	1.34	.500

\*Non-standard part, contact division for price and availability.

### TU - Tee Union

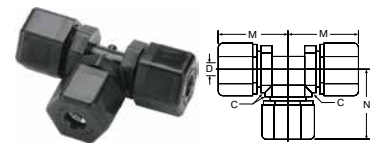

Tube to tube

WHITE PPL PART NO.	BLACK PPL PART NO.	WHITE NYLON PART NO.	NOM. TUBE O.D.	C HEX	M	N	FLOW DIA. D
W4TU4*	P4TU4	N4TU4	1/4	11/16	1.09	1.09	.170
W5TU5*	P5TU5	N5TU5	5/16	11/16	1.09	1.09	.187
W6TU6*	P6TU6	N6TU6	3/8	13/16	1.30	1.30	.250
	P8TU6	N8TU6	1/2-3/8	1	1.46	1.39	.250
W8TU8*	P8TU8	N8TU8	1/2	1	1.46	1.46	.375
W10TU6*	P10TU6	N10TU6	5/8-3/8	1-1/8	1.68	1.46	.250
	P10TU10	N10TU10	5/8	1-3/16	1.68	1.68	.500

\*Non-standard part, contact division for price and availability.

### FC - Female Connector



Tube to female pipe

WHITE PPL PART NO.	BLACK PPL PART NO.	WHITE NYLON PART NO.	NOM TUBE O.D.	NPTF THREAD SIZE	C HEX	L	FLOW DIA. D
	P4FC2	N4FC2	1/4	1/8	11/16	1.31	.170
W4FC4*	P4FC4	N4FC4	1/4	1/4	11/16	1.44	.170
W6FC4*	P6FC4	N6FC4	3/8	1/4	13/16	1.61	.250
W6FC6*	P6FC6	N6FC6	3/8	3/8	13/16	1.64	.250
W6FC8*	P6FC8	N6FC8	3/8	1/2	13/16	1.75	.250
W8FC6*	P8FC6	N8FC6	1/2	3/8	1	1.70	.375
W8FC8*	P8FC8	N8FC8	1/2	1/2	1	1.85	.375
	P10FC8	N10FC8	5/8	1/2	1-1/8	1.96	.500

\*Non-standard part, contact division for price and availability.

### MT - Male Branch Tee

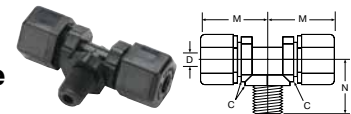

Tube to male pipe

WHITE PPL PART NO.	BLACK PPL PART NO.	WHITE NYLON PART NO.	NOM. TUBE O.D.	NPTF THD SIZE	C HEX	M	N	FLOW DIA. D
	P4MT2	N4MT2	1/4	1/8	11/16	1.09	0.89	.170
	P4MT4	N4MT4	1/4	1/4	11/16	1.09	1.06	.170
W5MT2*	P5MT2	N5MT2	5/16	1/8	11/16	1.09	0.89	.170
W5MT4*	P5MT4		5/16	1/4	11/16	1.09	1.06	.187
W6MT4*	P6MT4	N6MT4	3/8	1/4	13/16	1.30	1.12	.250
W6MT6*	P6MT6	N6MT6	3/8	3/8	13/16	1.30	1.10	.250
	P8MT6	N8MT6	1/2	3/8	1	1.46	1.22	.375
	P8MT8	N8MT8	1/2	1/2	1	1.46	1.43	.375
W10MT8*	P10MT8		5/8	1/2	1-1/8	1.68	1.41	.500

\*Non-standard part, contact division for price and availability.

\* Non-standard

**WARNING** These products can expose you to chemicals including CARBON BLACK, which is known to the state of California to cause cancer. For more information go to [www.P65Warnings.ca.gov](http://www.P65Warnings.ca.gov).



Click here for CADs, Product Specifications or to Configure Parts Online

### GR - Grab Ring



(Stainless or Plastic)

STAINLESS GRAB RING PART NUMBER	PLASTIC GRAB RING PART NUMBER	FOR NOM. TUBE O.D.
4GR	4GRP	1/4
5GR	5GRP	5/16
6GR	6GRP	3/8
8GR	8GRP	1/2
10GR	10GRP	5/8

### NS - Nut and Spacer Sets



WHITE POLYPROPYLENE PART NO.	BLACK POLYPROPYLENE PART NO.	WHITE NYLON PARTNUMBER	FOR NOM. TUBE O.D.
	P4NS	N4NS	1/4
	P5NS	N5NS	5/16
	P6NS	N6NS	3/8
	P8NS	N8NS	1/2
	P10NS	N10NS	5/8

\*Non-standard part, contact division for price and availability.

### TS - Tube Support



POLYPROPYLENE PART NO.	NYLON PART NO.	FOR TUBE PART NO.
P4TS3	N4TS3	PV43
P5TS3	N5TS3	PV53
P6TS4	N6TS4	PV64
P8TS6	N8TS6	PV86
P10TS8	N10TS8	PV108

### OR - O-Ring



FOR NOM. TUBE O.D.	NITRILE O-RING	FLUOROCARBON O-RING	EPDM O-RING
1/4	4OR	4OR-V	4OR-EPDM
5/16	5OR	5OR-V	5OR-EPDM
3/8	6OR	6OR-V	6OR-EPDM
1/2	8OR	8OR-V	8OR-EPDM
5/8	10OR	10OR-V	10OR-EPDM

**WARNING** These products can expose you to chemicals including CARBON BLACK, which is known to the state of California to cause cancer. For more information go to [www.P65Warnings.ca.gov](http://www.P65Warnings.ca.gov).



- A
- B
- C
- D
- E
- F
- G
- H
- I
- J
- K
- L
- M
- N
- O

Click here for CADs, Product Specifications or to Configure Parts Online

- A
- B
- C
- D
- E
- F
- G
- H
- I
- J
- K
- L
- M
- N
- O

## Fast and Tite Ball Valves

This range of ball valves uses compression technology to create a sure and tight connection. Use Parker's Fast and Tite fittings for low pressure applications such as water filtration, beverage dispensing, or on vacuum lines. Manufactured from black polypropylene material, these valves meet FDA and NSF-51 requirements for food contact.

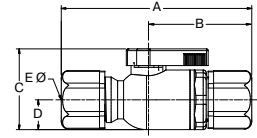

### Features/Benefits:

- 302 Stainless Steel Grab Ring
- Nitrile O-ring
- FDA Compliant
- NSF/ANSI-51 Compliant

### Specifications:

- Temperature Range: +35° F to +200° F (+1° C to +93° C)
- O-ring Seal Material: Nitrile
- NSF/ANSI 51
- Pressure Rated to 150PSI

### Assembly Instructions:

1. Cut the tube squarely and remove any burrs.
2. Mark from end of tube the length of insertion. If using a tube support, insert fully into tube before marking. (See insertion length table left)
3. Loosen nut on fitting until three threads are visible. Fittings for glass tubes must be disassembled and the grab ring removed. If the fitting has been disassembled the components are to be placed in the following order: fitting body, o-ring, spacer, grab ring and nut. Assemble the nut until three threads are showing on the body before inserting tube.
4. Moisten end of the tube with water. Push the tube straight into fitting until it bottoms on the fitting's shoulder. Tighten nut by hand. Additional tightening should not be necessary, but 1/4 additional turn may be added if desired. Do not overtighten nut as the threads will strip and the fitting will not function properly. A proper assembly will not show the insertion mark extending beyond the nut. If the insertion mark is visible, then steps 1 thru 4 must be repeated.
5. Whenever a Fast & Tite® fitting is assembled for service or reuse the stainless steel grab ring should be replaced for maximum tubing retention.

Note: Provide adequate fail-safe mechanisms such as leakage detection sensors, automatic shut-off controls or other industry and code appropriate fail-safe devices in the design of your water-handling appliance to protect against personal injury and property damage. Plastic fittings containing an o-ring have a finite life depending on the environment, media and severity of the application. Frequent inspections and replacement of the fitting when anomalies are found is recommended.

## VUC - Valve Union Connector

PART NO.	1 TUBE SIZE	2 TUBE SIZE	A	B	C	D	ØE THRU HOLE MIN.
FTPPB4VUC4	1/4	1/4	2.94	1.61	1.4	.5	.19
FTPPB4VUC6	1/4	3/8	3.07	1.61	1.4	.5	.19
FTPPB6VUC6	3/8	3/8	3.19	1.73	1.4	.5	.25
FTPPB8VUC8	1/2	1/2	3.27	1.80	1.4	.5	.38

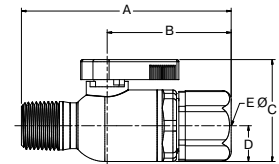

## VMC - Valve Male Connector

PART NO.	1 TUBE SIZE	NPTF THD SIZE	A	B	C	D	ØE THRU HOLE MIN.
FTPPB4VMC4	1/4	1/4	2.81	1.61	1.4	.5	.19
FTPPB4VMC6	1/4	3/8	2.81	1.61	1.4	.5	.19
FTPPB6VMC4	3/8	1/4	2.93	1.73	1.4	.5	.19
FTPPB6VMC6	3/8	3/8	2.93	1.73	1.4	.5	.25
FTPPB8VMC6	1/2	3/8	3.00	1.79	1.4	.5	.25

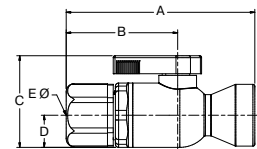

## VFC - Valve Female Connector

PART NO.	1 TUBE SIZE	NPTF THD SIZE	A	B	C	D	ØE THRU HOLE MIN.
FTPPB4VFC4	1/4	1/4	2.78	1.61	1.4	.5	.19
FTPPB6VFC6	3/8	3/8	2.93	1.73	1.4	.5	.25
FTPPB8VFC6	1/2	3/8	3.00	1.8	1.4	.5	.25

**WARNING** These products can expose you to chemicals including CARBON BLACK, which is known to the state of California to cause cancer. For more information go to [www.P65Warnings.ca.gov](http://www.P65Warnings.ca.gov).



Click here for CADs, Product Specifications or to Configure Parts Online

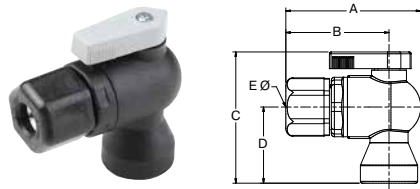

**VFE - Valve Female Elbow**

PART NO.	1 TUBE SIZE	NPTF THD SIZE	A	B	C	D	ØE THRU HOLE MIN.
FTPPB4VFE4	1/4	1/4	2.14	1.61	2.18	1.25	.19
FTPPB6VFE4	3/8	1/4	2.26	1.73	2.18	1.25	.19
FTPPB6VFE6	3/8	3/8	2.26	1.73	2.21	1.28	.25
FTPPB8VFE6	1/2	3/8	2.34	1.8	2.21	1.28	.25



**VME - Valve Male Elbow**

PART NO.	1 TUBE SIZE	NPTF THD SIZE	A	B	C	D	ØE THRU HOLE MIN.
FTPPB4VME4	1/4	1/4	2.14	1.61	2.21	1.28	.19
FTPPB6VME4	3/8	1/4	2.26	1.73	2.21	1.28	.19
FTPPB6VME6	3/8	3/8	2.26	1.73	2.21	1.28	.25
FTPPB8VME8	1/2	1/2	2.34	1.8	2.4	1.47	.38

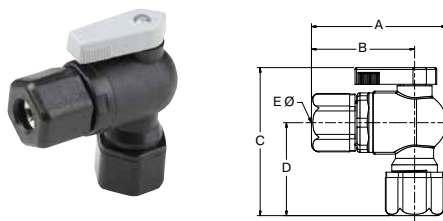

**VEU - Valve Elbow Union**

PART NO.	1 TUBE SIZE	2 TUBE SIZE	A	B	C	D	ØE THRU HOLE MIN.
FTPPB4VEU4	1/4	1/4	2.14	1.61	2.35	1.42	.19
FTPPB6VEU4	3/8	1/4	2.26	1.73	2.37	1.44	.19
FTPPB6VEU6	3/8	3/8	2.26	1.73	2.49	1.56	.25
FTPPB8VEU8	1/2	1/2	2.34	1.8	2.47	1.54	.38

**WARNING** These products can expose you to chemicals including CARBON BLACK, which is known to the state of California to cause cancer. For more information go to [www.P65Warnings.ca.gov](http://www.P65Warnings.ca.gov).



- A
- B
- C
- D
- E
- F
- G
- H
- I
- J
- K
- L
- M
- N
- O

A  
B  
C  
D  
E  
F  
G  
H  
I  
J  
K  
L  
M  
N  
O



# Par-Barb® Fittings

Parker's Par-Barb Fittings are injection molded from high strength chemically inert, thermoplastic materials. The multiple barb design generates the maximum gripping and sealing power when combined with a hose clamp.

### Product Features:

- Available in black polypropylene and white nylon
- FDA compliant material
- NSF/ANSI 51
- Uniprene washer
- Up to 1 1/2" sizes

### Markets:

- Water
- Beverage Dispensing
- Bottling
- Semi-Conductor

### Applications:

- Water
- Beverages
- Cooling Systems
- Vacuum



### Specifications:

**Pressure Range** Up to 125 psi PSI (8.6 bar)

### Temperature Range

Nylon: -40° to +200° F (-40° to +93.3° C)

Polypropylene: 0° to +212° F (-12.2° to +100° C)

### Compatible Tubing:

- Vinyl
- Polyurethane
- Rubber hose

**WARNING** These products can expose you to chemicals including NICKEL, CARBON BLACK, TITANIUM DIOXIDE, or LEAD, which are known to the state of California to cause cancer, and LEAD which is known to cause birth defects or other reproductive harm. For more information go to [www.P65Warnings.ca.gov](http://www.P65Warnings.ca.gov).

**Threaded Fittings**

**325HB**

Male Connector  
NPTF  
p. C41



**326HB**

Female Connector  
NPTF  
p. C41



**372HB**

Male Branch Tee  
NPTF  
p. C42



**370HB**

Female Elbow  
NPTF  
p. C42



**329HB**

Male Elbow  
NPTF  
p. C42



**Tube to Tube Fittings**

**322HB**

Union  
p. C40



**364HB**

Union Tee  
p. C40



**365HB**

Union Elbow  
p. C40



**362HB**

Union Y  
p. C42



**Pipe Fittings**

**318P**

Hex Plug  
p. C40



**309P**

Bushing  
p. C40



**316P**

Nipple  
p. C41



**Garden Hose Fittings**

**316GH**

Garden Hose  
Adapter  
p. C43



**325GH**

Garden Hose  
Connector  
p. C43



**Accessories**

**328HB**

Hose Barb Stem  
p. C43



**31HB**

Hose Barb  
Swivel Nut  
p. C43



**325GHSV**

Swivel Hose  
Barb Stem  
p. C43



**31GH**

Garden Hose Nut  
p. C43



**313GH**

Garden Hose Cap  
p. C43



**30GH**

Garden Hose Washer  
p. C43



**Ball Valves**

**VFC**

Female Connector  
p. C43



**VFE**

Female Elbow  
p. C44



**VMC**

Male Connector  
p. C44



**VME**

Male Elbow  
p. C44



**VUC**

Union Connector  
p. C44



**VUCPB**

Barb x Tuber  
p. C44



**VEU**

Parbarb Elbow  
Ball Valve  
p. C44



**BVC**

Ball Valve Clip  
p. C44



**WARNING** These products can expose you to chemicals including NICKEL, CARBON BLACK, TITANIUM DIOXIDE, or LEAD, which are known to the state of California to cause cancer, and LEAD which is known to cause birth defects or other reproductive harm. For more information go to [www.P65Warnings.ca.gov](http://www.P65Warnings.ca.gov).

A  
B  
C  
D  
E  
F  
G  
H  
I  
J  
K  
L  
M  
N  
O

Click here for CADs, Product Specifications or to Configure Parts Online



### Union Connector 322HB

WHITE NYLON PART NO.	BLACK POLYPROPYLENE PART NO.	TUBE OR HOSE I.D. 1	TUBE OR HOSE I.D. 2	O.D. 1	O.D. 2	L	FLOW DIA. D
322HB-2N*	322HB-2PP*	1/8	1/8	.18	.18	.66	.09
322HB-3N	322HB-3PP	3/16	3/16	.25	.25	1.61	.12
	322HB-4-2PP	1/4	1/8	.31	.21	1.61	.08
322HB-4-3N	322HB-4-3PP	1/4	3/16	.31	.25	1.61	.13
322HB-4N	322HB-4PP	1/4	1/4	.31	.31	1.61	.16
322HB-5N	322HB-5PP	5/16	5/16	.37	.37	1.61	.22
322HB-6-4N	322HB-6-4PP	3/8	1/4	.43	.31	1.61	.15
322HB-6-5N	322HB-6-5PP	3/8	5/16	.43	.37	1.62	.22
322HB-6N	322HB-6PP	3/8	3/8	.43	.43	1.61	.25
322HB-8-4N	322HB-8-4PP	1/2	1/4	.55	.31	1.73	.15
322HB-8-6N	322HB-8-6PP	1/2	3/8	.55	.43	1.73	.25
322HB-8N	322HB-8PP	1/2	1/2	.56	.56	1.74	.38
322HB-10-6N	322HB-10-6PP	5/8	3/8	.66	.43	1.73	.25
322HB-10-8N	322HB-10-8PP	5/8	1/2	.66	.55	1.73	.37
322HB-10N	322HB-10PP	5/8	5/8	.67	.67	1.73	.47
322HB-12-8N		3/4	1/2	.81	.55	2.99	.38
322HB-12N	322HB-12PP	3/4	3/4	.80	.80	2.97	.58
322HB-16N		1	1	1.08	1.08	3.12	.82
322HB-20N		1-1/4	1-1/4	1.26	1.26	3.58	1.00

\*Note: 1/8" tube connections contain one barb.



### Union Elbow 365HB

WHITE NYLON PART NO.	BLACK POLYPROPYLENE PART NO.	TUBE OR HOSE I.D. 1	TUBE OR HOSE I.D. 2	O.D. 1	O.D. 2	M	N	FLOW DIA. D
365HB-3N	365HB-3PP	3/16	3/16	.25	.25	.75	.75	.12
365HB-4N	365HB-4PP	1/4	1/4	.31	.31	1.13	1.13	.15
365HB-5N	365HB-5PP	5/16	5/16	.38	.37	1.19	1.19	.22
365HB-6N	365HB-6PP	3/8	3/8	.43	.43	1.26	1.26	.25
365HB-8-4N	365HB-8-4PP	1/2	1/4	.55	.31	1.26	1.24	.16
365HB-8-6N	365HB-8-6PP	1/2	3/8	.55	.43	1.26	1.27	.25
365HB-8N	365HB-8PP	1/2	1/2	.55	.55	1.26	1.26	.37
365HB-10N	365HB-10PP	5/8	5/8	.66	.66	1.37	1.37	.46
365HB-12N	365HB-12PP	3/4	3/4	.80	.80	1.48	1.48	.57
365HB-16N		1	1	1.07	1.07	1.50	1.50	.81
365HB-20N		1-1/4	1-1/4	1.25	1.25	2.63	2.63	1.00
365HB-24N		1-1/2	1-1/2	1.50	1.50	2.74	2.74	1.25



### Hex Plug 318P

WHITE NYLON PART NO.	BLACK POLYPROPYLENE PART NO.	NPT PIPE THREAD	C HEX	L
318P-2N	318P-2PP	1/8	7/16	.62
318P-4N	318P-4PP	1/4	9/16	.75
318P-6N	318P-6PP	3/8	11/16	.74
318P-8N	318P-8PP	1/2	7/8	.87
318P-12N	318P-12PP	3/4	1-1/8	.86
318P-16N	318P-16PP	1	1-3/8	1.05
318P-20N	318P-20PP	1-1/4	1-1/2	1.44
318P-24N	318P-24PP	1-1/2	1-3/4	1.61



### Reducer Bushing 309P

WHITE NYLON PART NO.	BLACK POLYPROPYLENE PART NO.	EXTERNAL NPT PIPE THREAD	INTERNAL NPT PIPE THREAD	C HEX	L
309P-4-2N	309P-4-2PP	1/4	1/8	9/16	.75
309P-6-2N		3/8	1/8	11/16	.74
309P-6-4N	309P-6-4PP	3/8	1/4	11/16	.75
309P-8-2N	309P-8-2PP	1/2	1/8	7/8	.88
309P-8-4N	309P-8-4PP	1/2	1/4	7/8	.87
309P-8-6N	309P-8-6PP	1/2	3/8	7/8	.87
	309P-12-2PP	3/4	1/8	1-1/8	.86
309P-12-4N	309P-12-4PP	3/4	1/4	1-1/8	.75
309P-12-6N	309P-12-6PP	3/4	3/8	1-1/8	.85
309P-12-8N	309P-12-8PP	3/4	1/2	1-1/8	.87

\*Note: 1/8" tube connections contain one barb.

**WARNING** These products can expose you to chemicals including NICKEL, CARBON BLACK, TITANIUM DIOXIDE, or LEAD, which are known to the state of California to cause cancer, and LEAD which is known to cause birth defects or other reproductive harm. For more information go to [www.P65Warnings.ca.gov](http://www.P65Warnings.ca.gov).





Click here for CADs, Product Specifications or to Configure Parts Online



### Hex Nipple 316P

WHITE NYLON PART NO.	BLACK POLYPROPYLENE PART NO.	NPT PIPE THREAD SIDE 1	NPT PIPE THREAD SIDE 2	C HEX	L	FLOW DIA. D
316P-2N	316P-2PP	1/8	1/8	7/16	.99	.22
316P-4-2N	316P-4-2PP	1/4	1/8	9/16	1.13	.22
316P-4N	316P-4PP	1/4	1/4	9/16	1.24	.31
316P-6-2N	316P-6-2PP	3/8	1/8	11/16	1.11	.22
316P-6-4N	316P-6-4PP	3/8	1/4	11/16	1.25	.31
316P-6N	316P-6PP	3/8	3/8	11/16	1.23	.43
316P-8-2N	316P-8-2PP	1/2	1/8	7/8	1.23	.22
316P-8-4N	316P-8-4PP	1/2	1/4	7/8	1.36	.31
316P-8-6N	316P-8-6PP	1/2	3/8	7/8	1.35	.43
316P-8N	316P-8PP	1/2	1/2	7/8	1.45	.59
316P-12-6N	316P-12-6PP	3/4	3/8	1-1/8	1.36	.43
316P-12-8N	316P-12-8PP	3/4	1/2	1-1/8	1.47	.59
316P-12N	316P-12PP	3/4	3/4	1-1/8	1.48	.74
316P-16N	316P-16PP	1	1	1-3/8	1.85	.98



### Male Connector 325HB

WHITE NYLON PART NO.	BLACK POLYPROPYLENE PART NO.	TUBE OR HOSE I.D.	NPT PIPE THD.	O.D.	C HEX	L	FLOW DIA. D
325HB-3-2N	325HB-3-2PP	3/16	1/8	.25	7/16	1.49	.12
325HB-3-4N	325HB-3-4PP	3/16	1/4	.25	9/16	1.61	.13
325HB-4-2N	325HB-4-2PP	1/4	1/8	.31	7/16	1.50	.15
325HB-4-4N	325HB-4-4PP	1/4	1/4	.31	9/16	1.60	.16
325HB-4-6N		1/4	3/8	.31	11/16	1.62	.16
325HB-4-8N	325HB-4-8PP	1/4	1/2	.31	7/8	1.73	.15
325HB-4-12N		1/4	3/4	.31	1-1/8	1.74	.16
325HB-5-2N		5/16	1/8	.37	7/16	1.50	.22
325HB-5-4N		5/16	1/4	.37	9/16	1.62	.22
325HB-5-6N	325HB-5-6PP	5/16	3/8	.37	11/16	1.60	.21
325HB-6-2N	325HB-6-2PP	3/8	1/8	.43	7/16	1.49	.25
325HB-6-4N	325HB-6-4PP	3/8	1/4	.43	9/16	1.62	.25
325HB-6-6N	325HB-6-6PP	3/8	3/8	.43	11/16	1.61	.25
325HB-6-8N	325HB-6-8PP	3/8	1/2	.43	7/8	1.73	.25
325HB-6-12N	325HB-6-12PP	3/8	3/4	.43	1-1/8	1.72	.25
325HB-8-4N	325HB-8-4PP	1/2	1/4	.55	9/16	1.61	.35
325HB-8-6N	325HB-8-6PP	1/2	3/8	.55	11/16	1.60	.37
325HB-8-8N	325HB-8-8PP	1/2	1/2	.55	7/8	1.73	.37
325HB-8-12N	325HB-8-12PP	1/2	3/4	.55	1-1/8	1.72	.37
325HB-10-6N	325HB-10-6PP	5/8	3/8	.66	11/16	1.61	.46
325HB-10-8N	325HB-10-8PP	5/8	1/2	.66	7/8	1.73	.46
325HB-10-12N	325HB-10-12PP	5/8	3/4	.67	1-1/8	1.82	.46
325HB-12-8N	325HB-12-8PP	3/4	1/2	.80	7/8	1.86	.62
325HB-12-12N	325HB-12-12PP	3/4	3/4	.80	1-1/8	1.85	.62
325HB-12-16N		3/4	1	.82	1-3/8	2.35	.59
325HB-12-20N		3/4	1-1/4	.86	1-1/2	3.47	.59
325HB-12-24N		3/4	1-1/2	.86	1-3/4	3.66	.59
325HB-16-8N		1	1/2	1.08	1-1/8	2.49	.77
325HB-16-12N		1	3/4	1.07	1-1/8	2.30	.81
325HB-16-16N		1	1	1.07	1-3/8	2.35	.81
325HB-16-20N		1	1-1/4	1.11	1-1/2	3.45	.78
325HB-16-24N		1	1-1/2	1.11	1-3/4	3.63	.78
325HB-20-20N		1-1/4	1-1/4	1.36	1-1/2	3.47	1.04
325HB-20-24N		1-1/4	1-1/2	1.36	1-3/4	3.64	1.04
325HB-24-20N		1-1/2	1-1/4	1.60	1-1/2	3.45	1.28
325HB-24-24N		1-1/2	1-1/2	1.61	1-3/4	3.63	1.28



### Female Connector 326HB

WHITE NYLON PART NO.	BLACK POLYPROPYLENE PART NO.	TUBE OR HOSE I.D.	NPT PIPE THREAD	O.D.	C HEX	L	FLOW DIA. D
326HB-3-2N	326HB-3-2PP	3/16	1/8	.25	5/8	1.29	.12
	326HB-3-4PP	3/16	1/4	.25	3/4	1.31	.13
326HB-4-2N	326HB-4-2PP	1/4	1/8	.31	5/8	1.51	.16
326HB-4-4N	326HB-4-4PP	1/4	1/4	.31	3/4	1.52	.15
326HB-4-6N	326HB-4-6PP	1/4	3/8	.31	1	1.73	.15
	326HB-4-8PP	1/4	1/2	.31	1-1/8	1.74	.15
	326HB-6-2PP	3/8	1/8	.44	5/8	1.51	.25
326HB-6-4N	326HB-6-4PP	3/8	1/4	.43	3/4	1.52	.25
326HB-6-6N	326HB-6-6PP	3/8	3/8	.43	1	1.73	.25
	326HB-6-8PP	3/8	1/2	.43	1-1/8	1.74	.25
326HB-8-4N	326HB-8-4PP	1/2	1/4	.55	3/4	1.52	.37
	326HB-8-6PP	1/2	3/8	.55	1	1.74	.37
326HB-8-8N	326HB-8-8PP	1/2	1/2	.56	1-1/8	1.74	.37
326HB-10-6N	326HB-10-6PP	5/8	3/8	.66	1	1.61	.46
	326HB-10-8PP	5/8	1/2	.66	1-1/8	1.73	.46
326HB-12-8N	326HB-12-8PP	3/4	1/2	.80	1-1/8	1.86	.62
326HB-12-12N	326HB-12-12PP	3/4	3/4	.80	1-1/8	1.85	.62

**WARNING** These products can expose you to chemicals including NICKEL, CARBON BLACK, TITANIUM DIOXIDE, or LEAD, which are known to the state of California to cause cancer, and LEAD which is known to cause birth defects or other reproductive harm. For more information go to [www.P65Warnings.ca.gov](http://www.P65Warnings.ca.gov).



Click here for CADs, Product Specifications or to Configure Parts Online



**Male Branch Tee 372HB**

WHITE NYLON PART NO.	BLACK POLYPROPYLENE PART NO.	TUBE OR HOSE I.D.	NPT PIPE THD.	O.D.	C HEX	L	N	FLOW DIA. D
372HB-3-2N		3/16	1/8	.25	7/16	1.94	1.06	.13
372HB-3-4N		3/16	1/4	.24	9/16	1.93	1.17	.13
372HB-4-2N	372HB-4-2PP	1/4	1/8	.32	7/16	1.92	1.06	.16
372HB-4-4N	372HB-4-4PP	1/4	1/4	.32	9/16	1.92	1.16	.16
	372HB-4-6PP	1/4	3/8	.32	11/16	1.92	1.18	.16
372HB-6-4N	372HB-6-4PP	3/8	1/4	.43	9/16	2.22	1.18	.25
	372HB-6-6PP	3/8	3/8	.43	11/16	2.22	1.17	.25
372HB-6-8N	372HB-6-8PP	3/8	1/2	.43	7/8	2.22	1.29	.25
372HB-8-4N	372HB-8-4PP	1/2	1/4	.55	9/16	2.52	1.17	.37
372HB-8-6N	372HB-8-6PP	1/2	3/8	.56	11/16	2.52	1.17	.37
372HB-8-8N	372HB-8-8PP	1/2	1/2	.55	7/8	2.52	1.30	.37
372HB-12-12N	372HB-12-12PP	3/4	3/4	.81	1-1/8	2.97	1.92	.58
372HB-16-8N		1	1/2	1.07	7/8	3.10	1.74	.81



**Male Elbow 329HB**

WHITE NYLON PART NO.	BLACK POLYPROPYLENE PART NO.	TUBE OR HOSE I.D.	NPT PIPE THD.	O.D.	C HEX	M	N	FLOW DIA. D
329HB-3-2N	329HB-3-2PP	3/16	1/8	.25	7/16	.76	1.06	.12
329HB-3-4N		3/16	1/4	.25	9/16	.76	1.17	.13
329HB-4-2N	329HB-4-2PP	1/4	1/8	.31	7/16	1.18	1.04	.16
329HB-4-4N	329HB-4-4PP	1/4	1/4	.31	9/16	1.18	1.16	.22
329HB-4-6N	329HB-4-6PP	1/4	3/8	.31	11/16	1.18	1.17	.15
329HB-4-8N	329HB-4-8PP	1/4	1/2	.32	7/8	1.18	1.30	.15
329HB-5-2N		5/16	1/8	.37	7/16	1.18	1.06	.22
329HB-6-2N	329HB-6-2PP	3/8	1/8	.43	7/16	1.18	1.05	.25
329HB-6-4N	329HB-6-4PP	3/8	1/4	.43	9/16	1.18	1.16	.25
329HB-6-6N	329HB-6-6PP	3/8	3/8	.43	11/16	1.17	1.17	.25
329HB-6-8N	329HB-6-8PP	3/8	1/2	.43	7/8	1.18	1.28	.25
329HB-8-4N	329HB-8-4PP	1/2	1/4	.55	9/16	1.27	1.16	.37
329HB-8-6N	329HB-8-6PP	1/2	3/8	.56	11/16	1.26	1.16	.37
329HB-8-8N	329HB-8-8PP	1/2	1/2	.55	7/8	1.25	1.29	.37
329HB-8-12N	329HB-8-12PP	1/2	3/4	.55	1-1/8	1.30	1.89	.37
329HB-10-6N		5/8	3/8	.67	11/16	1.27	1.18	.47
329HB-10-8N	329HB-10-8PP	5/8	1/2	.68	7/8	1.30	1.73	.48
329HB-10-12N	329HB-10-12PP	5/8	3/4	.69	1-1/8	1.32	1.92	.49
329HB-12-8N	329HB-12-8PP	3/4	1/2	.81	7/8	1.51	1.74	.58
329HB-12-12N	329HB-12-12PP	3/4	3/4	.81	1-1/8	1.50	1.91	.58
329HB-12-16N		3/4	1	.82	1-3/8	1.49	1.98	.58
329HB-12-20N		3/4	1-1/4	.86	1-1/2	1.52	2.39	.59
329HB-12-24N		3/4	1-1/2	.85	1-1/2	2.26	3.09	.59
329HB-16-8N		1	1/2	1.12	7/8	1.58	1.78	.86
329HB-16-12N		1	3/4	1.11	1-1/8	1.58	1.93	.86
329HB-16-16N		1	1	1.08	1-3/8	1.55	1.98	.81
329HB-16-20N		1	1-1/4	1.12	1-1/2	2.28	2.93	.84
329HB-16-24N		1	1-1/2	1.12	1-1/2	2.27	3.11	.84
329HB-20-24N		1-1/4	1-1/2	1.36	1-1/2	2.63	3.11	1.08
329HB-24-20N		1-1/2	1-1/4	1.60	1-1/2	2.77	2.93	1.30
329HB-24-24N		1-1/2	1-1/2	1.60	1-1/2	2.77	3.10	1.30



**Female Elbow 370HB**

WHITE NYLON PART NO.	BLACK POLYPROPYLENE PART NO.	TUBE OR HOSE I.D.	NPT PIPE THD.	O.D.	C HEX	M	N	FLOW DIA. D
370HB-4-2N	370HB-4-2PP	1/4	1/8	.31	5/8	1.19	1.07	.16
370HB-4-4N	370HB-4-4PP	1/4	1/4	.31	3/4	1.18	1.08	.16
	370HB-4-6PP	1/4	3/8	.31	1	1.16	1.30	.16
	370HB-4-8PP	1/4	1/2	.31	1-1/8	1.18	1.30	.15
370HB-6-4N		3/8	1/4	.44	3/4	1.18	1.06	.25
370HB-6-6N	370HB-6-6PP	3/8	3/8	.43	1	1.18	1.29	.25
	370HB-6-8PP	3/8	1/2	.43	1-1/8	1.18	1.29	.25
370HB-8-4N	370HB-8-4PP	1/2	1/4	.55	3/4	1.25	1.22	.37
370HB-8-6N	370HB-8-6PP	1/2	3/8	.55	1	1.25	1.44	.37
370HB-8-8N	370HB-8-8PP	1/2	1/2	.55	1-1/8	1.25	1.45	.37
	370HB-8-12PP	1/2	3/4	.55	1-3/8	1.26	1.72	.37
370HB-12-12N	370HB-12-12PP	3/4	3/4	.80	1-3/8	1.38	1.84	.59

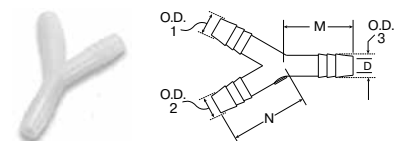

**Union Y 362HB**

WHITE NYLON PART NO.	TUBE OR HOSE I.D. 1 & 2	TUBE OR HOSE I.D. 3	O.D. 1 & 2	O.D. 3	M	N	FLOW DIA. D
362HB-4N	1/4	1/4	.31	.31	1.13	1.13	.16
362HB-6N	3/8	3/8	.43	.43	1.25	1.40	.25
362HB-8N	1/2	1/2	.55	.55	1.25	1.50	.38

**WARNING** These products can expose you to chemicals including NICKEL, CARBON BLACK, TITANIUM DIOXIDE, or LEAD, which are known to the state of California to cause cancer, and LEAD which is known to cause birth defects or other reproductive harm. For more information go to [www.P65Warnings.ca.gov](http://www.P65Warnings.ca.gov).



Click here for CADs, Product Specifications or to Configure Parts Online



### Ball Nose Hose Barb Stem 328HB

WHITE NYLON PART NO.	BLACK POLYPROPYLENE PART NO.	TUBE OR HOSE I.D.	SWIVEL NUT NPT PIPE THREAD	O.D.	L	FLOW DIA. D
328HB-4BN	328HB-4BPP	1/4	1/4 *	.30	1.19	.19
328HB-4-8BN	328HB-4-8BPP	1/4	1/2 *	.30	1.29	.15
328HB-6BN	328HB-6BPP	3/8	3/8 *	.56	1.41	.25
328HB-8BN	328HB-8BPP	1/2	1/2 *	.67	1.30	.37

\*Use with hose barb swivel nut (31HB-XX) for desired NPT thread.

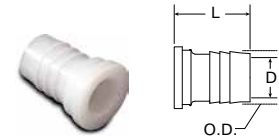

### Garden Hose Swivel Hose Barb Stem 325GHSV

WHITE NYLON PART NO.	TUBE OR HOSE I.D.	GARDEN HOSE THREAD	O.D.	L	FLOW DIA. D
325GHSV-4-12BN*	1/4	3/4	.31	1.16	.16
325GHSV-6-12BN*	3/8	3/4	.44	1.17	.25
325GHSV-8-12BN*	1/2	3/4	.56	1.17	.38
325GHSV-10-12BN*	5/8	3/4	.64	1.18	.47
325GHSV-12-12BN*	3/4	3/4	.81	1.18	.62

\*Use with Garden Hose washer (30GH-12) and Garden Hose Nut (31GH-12N)



### Hose Barb Swivel Nut 31HB

WHITE NYLON PART NO.	BLACK POLYPROPYLENE PART NO.	NPT PIPE THREAD	C HEX	L
31HB-6N	31HB-6PP	3/8	7/8	.63

### Garden Hose Nut 31GH

WHITE NYLON PART NO.	GARDEN HOSE THREAD	L	DIA. N
31GH-12N	3/4	.74	1.38

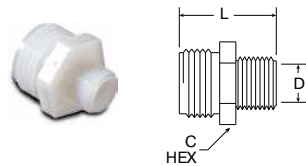

### Male Garden Hose - Male Pipe Adapter 316GH

WHITE NYLON PART NO.	GARDEN HOSE THREAD	NPT PIPE THREAD	C HEX	L	FLOW DIA. D
316GH-12-6N	3/4	3/8	1- 1/8	1.33	.44
316GH-12-8N	3/4	1/2	1- 1/8	1.44	.59
316GH-12-12N	3/4	3/4	1- 1/8	1.48	.75

### Garden Hose Cap 313GH

WHITE NYLON PART NO.	GARDEN HOSE THREAD	L	DIA. N
313GH-12N**	3/4	.74	1.38

\*\*Use with Garden Hose Washer (30GH-12)

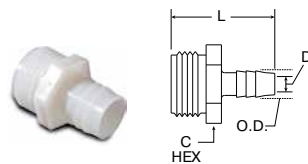

### Male Garden Hose - Hose Barb 325GH

WHITE NYLON PART NO.	TUBE OR HOSE I.D.	GARDEN HOSE THREAD	O.D.	C HEX	L	FLOW DIA. D
325GH-4-12N	1/4	3/4	.31	1- 1/8	1.70	.16
325GH-6-12N	3/8	3/4	.44	1- 1/8	1.69	.25
325GH-8-12N	1/2	3/4	.55	1- 1/8	1.68	.38
325GH-10-12N	5/8	3/4	.64	1- 1/8	1.70	.47
325GH-12-12N	3/4	3/4	.81	1- 1/8	1.70	.62

### Garden Hose Washer 30GH

WHITE TPE PART NO.	GARDEN HOSE THREAD	L
30GH-12	3/4	.13

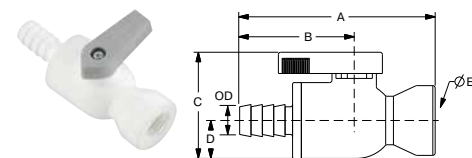

### VFC - Valve Barbed Female Connector

PART NO.	HOSE I.D.	NPTF THD.	O.D.	A	B	C	D	ØE THRU HOLE MIN.
PBPP4VFC4	1/4	1/4	.31	2.76	1.60	1.41	.50	.15
PBPP6VFC6	3/8	3/8	.43	2.79	1.60	1.41	.50	.19

**WARNING** These products can expose you to chemicals including NICKEL, CARBON BLACK, TITANIUM DIOXIDE, or LEAD, which are known to the state of California to cause cancer, and LEAD which is known to cause birth defects or other reproductive harm. For more information go to [www.P65Warnings.ca.gov](http://www.P65Warnings.ca.gov).



[Click here for CADs, Product Specifications or to Configure Parts Online](#)

- A
- B
- C
- D
- E
- F
- G
- H
- I
- J
- K
- L
- M
- N
- O

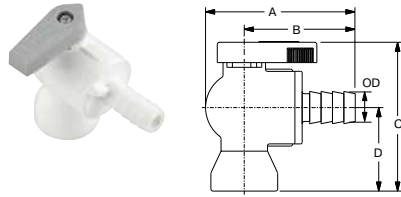

**VFE - Valve Barbed Female Elbow**

PART NO.	HOSE I.D.	NPTF THD.	O.D.	A	B	C	D	ØE THRU HOLE MIN.
PBPP4VFE4	1/4	1/4	.31	2.13	1.60	2.05	1.15	.15
PBPP6VFE4	3/8	1/4	.43	2.13	1.60	2.05	1.15	.15
PBPP6VFE6	3/8	3/8	.43	2.13	1.60	2.18	1.28	.19

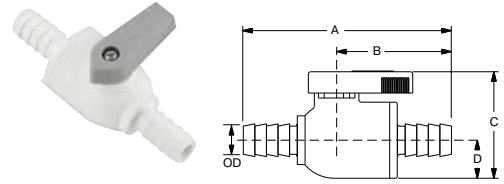

**VUC - Valve Barbed Union Connector**

PART NO.	HOSE I.D.	O.D.	A	B	C	D	ØE THRU HOLE MIN.
PBPP4VUC4	1/4	.31	2.91	1.60	1.42	.50	.15
PBPP6VUC6	3/8	.43	2.91	1.60	1.42	.50	.19
PBPP8VUC8	1/2	.55	2.91	1.60	1.42	.50	.25

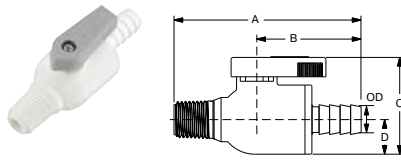

**VMC - Valve Barbed Male Connector**

PART NO.	HOSE I.D.	NPTF THD.	O.D.	A	B	C	D	ØE THRU HOLE MIN.
PBPP4VMC4	1/4	1/4	.31	2.79	1.60	1.42	.50	.15
PBPP6VMC6	3/8	3/8	.43	2.79	1.60	1.42	.50	.19

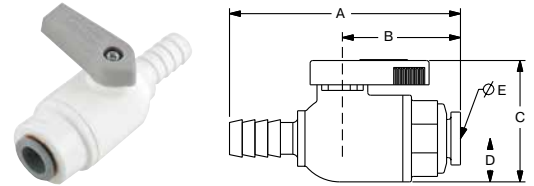

**VUCPB - Valve Union Connector Barbed x Tube**

PART NO.	HOSE ID	TUBE OD	OD	A	B	C	D	ØE THRU HOLE MIN.
LFPP4VUCPB4	1/4	1/4	.31	2.40	1.08	1.42	.50	.15
LFPP6VUCPB6	3/8	3/8	.43	2.63	1.32	1.42	.50	.19

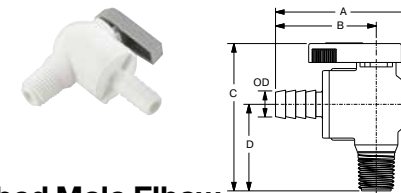

**VME - Valve Barbed Male Elbow**

PART NO.	HOSE I.D.	NPTF THD.	O.D.	A	B	C	D	ØE THRU HOLE MIN.
PBPP4VME4	1/4	1/4	.31	2.13	1.60	2.18	1.28	.15
PBPP6VME6	3/8	3/8	.43	2.13	1.60	2.18	1.28	.19

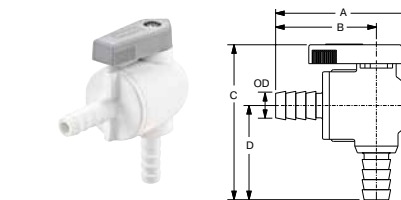

**VEU - Parbarb Elbow Ball Valve**

PART NO.	HOSE I.D.	O.D.	A	B	C	D	ØE THRU HOLE MIN.
PBPP4VEU4	1/4	.31	2.13	1.57	2.32	1.40	.15
PBPP6VEU6	3/8	.43	2.13	1.60	2.32	1.40	.25
PBPP8VEU8	1/2	.55	2.13	1.60	2.32	1.40	.25

**BVC Ball Valve Clip**

BV-Clip Shown below holding VUCPB and VME

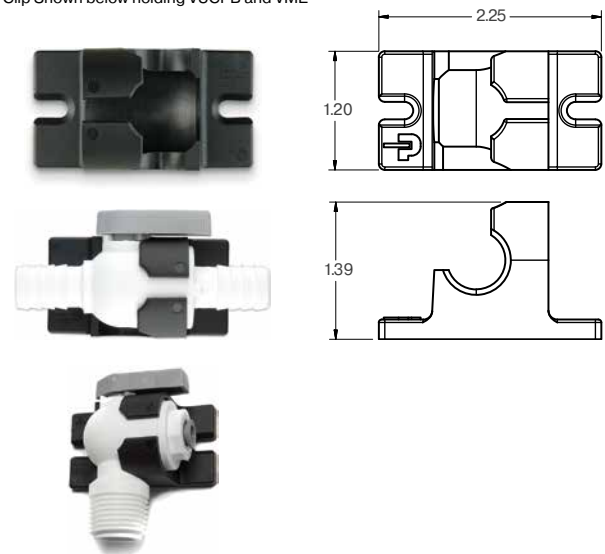

**WARNING** These products can expose you to chemicals including NICKEL, CARBON BLACK, TITANIUM DIOXIDE, or LEAD, which are known to the state of California to cause cancer, and LEAD which is known to cause birth defects or other reproductive harm. For more information go to [www.P65Warnings.ca.gov](http://www.P65Warnings.ca.gov).







# Cartridges

Carstick® Cartridges

LIQUIfit® Cartridges

TrueSeal™ Cartridges

PLM/PLS Cartridges

SAE Encapsulated Cartridges





- A
- B
- C
- D
- E
- F
- G
- H
- I
- J
- K
- L
- M
- N
- O



# Cartridges

Parker has developed a range of cartridges guaranteeing the integrity of the sealing system before and after assembly in non-threaded cavities. The compact design of the one-piece cartridges enables automation of your manufacturing process and improves the reliability of your system.

### Product Features:

- Self-centering of the cartridge in the cavity
- Push-in connection
- Designed for automation assembly process
- SAE & NSF cartridges available

### Markets:

- Industrial
- Pneumatic
- Filtration
- Semi-Conductor
- Life Science
- Automation
- Heavy Duty Truck

### Applications:

- Air
- Water
- Beverage Dispensing
- Cab Controls
- Packaging
- Labeling
- Vacuum

### Specifications:

	Seals	Pressure	Temperature
<b>Carstick</b>	Nitrile	Up to 290 PSI (20 bar)	-4° to +175° F (-20° to +79.4° C)
<b>PLM/PLS</b>	FKM	Up to 435 PSI (30 bar)	-13° to +302° F (-25° to +150° C)
<b>LIQUIfit</b>	EPDM	Up to 230 PSI (15.9 bar)	35° to +200° F (+1.7° to +93.3° C)
<b>TrueSeal</b>	EPDM	Up to 150 PSI (10.3 bar)	-20° to +180° F (-28.9° to +82.2° C)
<b>PTC</b>	Nitrile	Up to 250 PSI (17.2 bar)	-40° to +200° F (-40° to +93.3° C)

**WARNING** These products can expose you to chemicals including NICKEL or LEAD, which are known to the state of California to cause cancer, and LEAD which is known to cause birth defects or other reproductive harm. For more information go to [www.P65Warnings.ca.gov](http://www.P65Warnings.ca.gov).





**Carstick Cartridges**

**3100**  
Carstick® Cartridge  
Brass  
p. D6



**3100**  
Carstick® Cartridge  
Nickel-Plated Brass  
p. D6



**Liquifit Cartridges**

**6300**  
LIQUIfit Cartridge  
Brass  
p. D8



**6300**  
LIQUIfit Cartridge  
Nickel-Plated Brass  
p. D8



**TrueSeal Cartridges**

**TSC**  
Cartridge Insert  
p. D10



**PLM/PLS Cartridges**

**PLMC**  
Cartridge  
p. D11



**PLSC**  
Cartridge  
p. D11



**SAE Encapsulated Cartridges**

**PTCCE**  
Encapsulated  
p. D12



**WARNING** These products can expose you to chemicals including NICKEL or LEAD, which are known to the state of California to cause cancer, and LEAD which is known to cause birth defects or other reproductive harm. For more information go to [www.P65Warnings.ca.gov](http://www.P65Warnings.ca.gov).

- A
- B
- C
- D**
- E
- F
- G
- H
- I
- J
- K
- L
- M
- N
- O

[Click here for CADs, Product Specifications or to Configure Parts Online](#)

# Carstick® Cartridges

## Component Materials

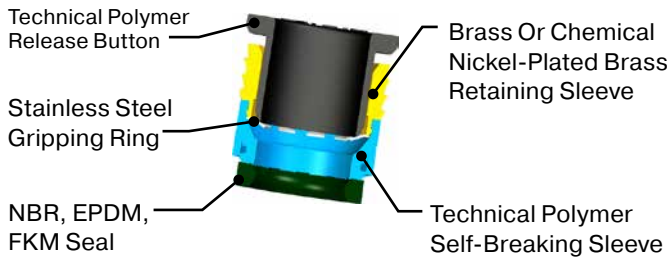

### 3100 Carstick® Cartridge Brass

PART NO.	OD	G	G1	H	L	KG
3100 04 00	4	8	11	10	554	.001
3100 06 00	6	10	14.5	11.5	629	.002
3100 08 00	8	13	15	15	794	.002
3100 10 00	10	15.5	19.5	17	930	.005
3100 12 00	12	19.5	21	19.5	1038	.010

50 cartridges per Carstick®

### 3100 Carstick® Cartridge Nickel-Plated Brass Inch

PART NO.	OD	G	G1	H	L	KG
3100 53 00 99	1/8	7	10	9	508	.002
3100 56 00 99	1/4	10.5	14.5	12	600	.003
3100 60 00 99	3/8	15.5	19	16.5	930	.006

50 cartridges per Carstick®  
5/32" (4mm) and 5/16" (8mm) also available

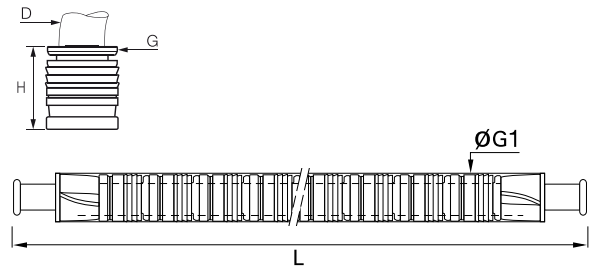
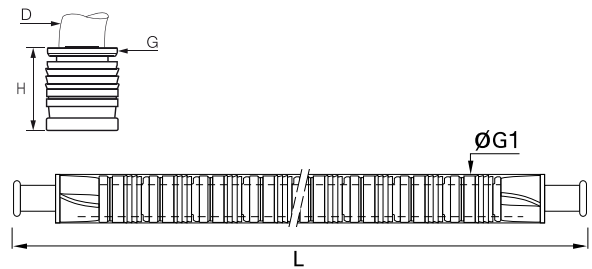

## Installation

1. Self-centering of the cartridge in the cavity.
2. The seal protection is broken. The seal slides into the cavity. The cartridge is in place.
3. Tube connection.

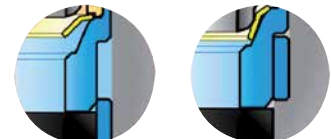
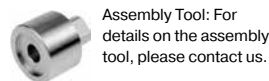
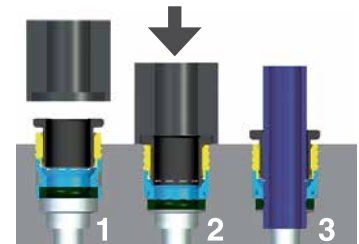

**WARNING** These products can expose you to chemicals including NICKEL or LEAD, which are known to the state of California to cause cancer, and LEAD which is known to cause birth defects or other reproductive harm. For more information go to [www.P65Warnings.ca.gov](http://www.P65Warnings.ca.gov).

[Click here for CADs, Product Specifications or to Configure Parts Online](#)

### Carstick® Cavity Dimensions

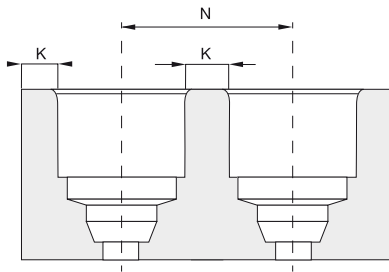
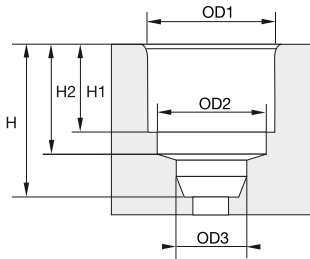

Please consult us for detailed drawings of cavity dimensions and tolerances. All our dimensions are in millimeters.

#### Carstick® & Quick Fitting Metric

CAVITY	OD3	H	H1	H2
4	4.1	10	6	8.15
6	6.1	12	7.5	9.65
8	8.15	15.5	9.9	12.45
10	10.25	19	11.7	14.35
12	12.17	22	13.9	16.75

#### Carstick® Inch

CAVITY	OD3	H	H1	H2
1/8	3.25	7.45	5.3	9.5
5/32 *	4.1	8.15	6	10
1/4	6.45	10.15	8	12.5
5/16 *	8.15	12.45	9.9	15.5
3/8	9.65	14.35	11.7	19
1/2	12.8	26.1	16.9	20.1

#### Polyamide Cavity

CAVITY	OD1	OD2	N*	K
4	8.25	7.05	9.8	1.5
6	10.2	9.15	12.2	2
8	12.15	10.85	14.2	2
10	14.8	13.2	16.8	2
12	17.5	15.5	20	2.5

CAVITY	OD1	OD2	N	K
1/8	7.05	6.02	8.6	1.5
5/32*	8.25	7.05	9.75	1.5
1/4	10.55	9.35	12.6	2
5/16*	12.15	10.85	14.2	2
3/8	14.8	13.1	16.8	2
1/2	19.86	17.82	24.85	2.5

#### Aluminum Cavity

CAVITY	OD1	OD2	N*	K
4	8.25	7.5	11.5	3
6	10.3	9.15	13.5	3
8	12.2	10.85	15.2	3
10	15.05	13.2	17.1	2
12	17.5	15.5	20	2.5

CAVITY	OD1	OD2	N	K
1/8	7.1	6.2	8.6	1.5
5/32*	8.25	7.05	11.25	3
1/4	10.6	9.35	12.65	2
5/16*	12.2	10.85	15.2	3
3/8	15.05	13.1	17.1	2

#### Brass Cavity

CAVITY	OD1	OD2	N*	K
4	8.25	7.05	10.25	2
6	10.25	9.1	12.25	2
8	12.2	10.85	14.25	2
10	15.05	13.2	17.1	2
12	17.65	15.5	20	2.5

CAVITY	OD1	OD2	N	K
1/8	7.1	6.2	8.6	1.5
5/32*	8.25	7.05	10.25	2
1/4	10.6	9.35	12.65	2
5/16*	12/2	10.85	14.25	2
3/8	10.05	13.1	17.1	2

\* Carstick®

\*5/32"=4mm and 5/16"=8mm

**WARNING** These products can expose you to chemicals including NICKEL or LEAD, which are known to the state of California to cause cancer, and LEAD which is known to cause birth defects or other reproductive harm. For more information go to [www.P65Warnings.ca.gov](http://www.P65Warnings.ca.gov).



- A
- B
- C
- D
- E
- F
- G
- H
- I
- J
- K
- L
- M
- N
- O

Click here for CADs, Product Specifications or to Configure Parts Online

# LIQUIfit® Cartridges

- A
- B
- C
- D**
- E
- F
- G
- H
- I
- J
- K
- L
- M
- N
- O



## 6300 LIQUIfit Cartridge Brass Metric

PART NO.	OD	G	G1	H	L	KG
6300 04 00	4	8	11	10	554	.002
6300 06 00	6	10	14.5	11.5	629	.002
6300 08 00	8	13	15	15	794	.003
6300 10 00	10	15.5	19.5	17	930	.005
6300 12 00	12	18.5	21	19.5	1038	.010

50 cartridges per Carstick®

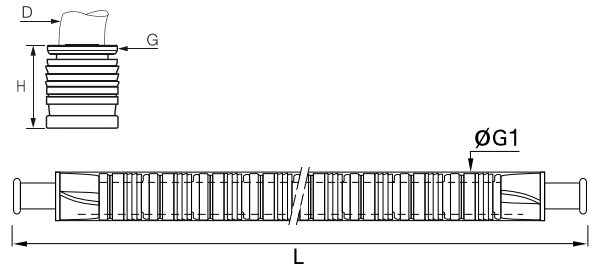

## 6300 LIQUIfit Cartridge Brass Inch

PART NO.	OD	G	G1	H	L	KG
6300 56 00	1/4	10.5	14.5	12.5	600	.002
6300 60 00	3/8	15.5	19	17	930	.005
6300 62 00	1/2	22	25	23	1038	.011

50 cartridges per Carstick®  
5/32" (4mm) and 5/16" (8mm) also available

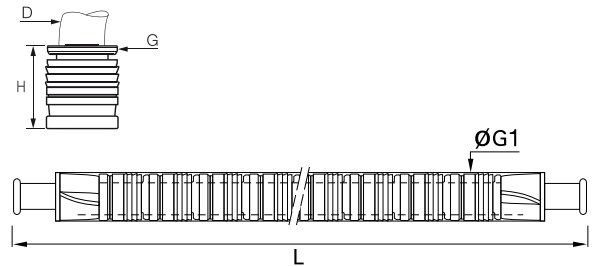

### Installation

1. Self-centering of the cartridge in the cavity.
2. The seal protection is broken. The seal slides into the cavity. The cartridge is in place.
3. Tube connection.

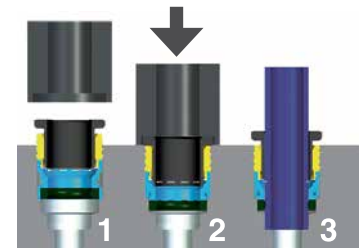

 Assembly Tool: For details on the assembly tool, please contact us.



**WARNING** These products can expose you to chemicals including NICKEL or LEAD, which are known to the state of California to cause cancer, and LEAD which is known to cause birth defects or other reproductive harm. For more information go to [www.P65Warnings.ca.gov](http://www.P65Warnings.ca.gov).



[Click here for CADs, Product Specifications or to Configure Parts Online](#)

### LIQUIft® Carstick® Cavity Dimensions

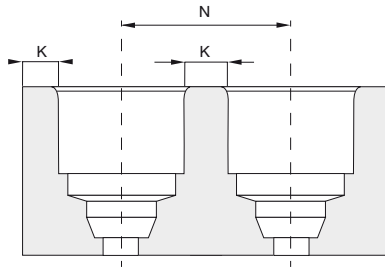
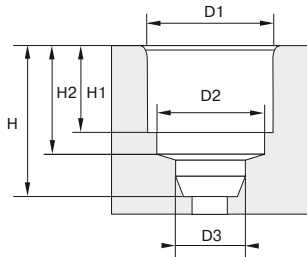

Please consult us for detailed drawings of cavity dimensions and tolerances. All our dimensions are in millimeters.

#### LIQUIft® Carstick® Metric

CAVITY	OD3	H	H1	H2
4	4.1	10	6	8.15
6	6.1	12	7.5	9.65
8	8.15	15.5	9.9	12.45
10	10.25	19	11.7	14.35
12	12.17	22	13.9	16.75

#### LIQUIft® Carstick® Inch

CAVITY	OD3	H	H1	H2
1/8	3.25	7.45	5.3	9.5
5/32*	4.1	8.15	6	10
1/4	6.45	10.15	8	12.5
5/16*	8.15	12.45	9.9	15.5
3/8	9.65	14.35	11.7	19

#### Polyamide Cavity

CAVITY	OD1	OD2	N*	K
4	8.25	7.05	9.8	1.5
6	10.2	9.15	12.2	2
8	12.15	10.85	14.2	2
10	14.8	13.2	16.8	2
12	17.5	15.5	20	2.5

CAVITY	OD1	OD2	N	K
1/8	7.05	6.02	8.6	1.5
5/32*	8.25	7.05	9.75	1.5
1/4	10.55	9.35	12.6	2
5/16*	12.15	10.85	14.2	2
3/8	14.8	13.1	16.8	2

#### Aluminum Cavity

CAVITY	OD1	OD2	N*	K
4	8.25	7.5	11.5	3
6	10.3	9.15	13.5	3
8	12.2	10.85	15.2	3
10	15.05	13.2	17.1	2
12	17.5	15.5	20	2.5

CAVITY	OD1	OD2	N	K
1/8	7.1	6.2	8.6	1.5
5/32*	8.25	7.05	11.25	3
1/4	10.6	9.35	12.65	2
5/16*	12.2	10.85	15.2	3
3/8	15.05	13.1	17.1	2

#### Brass Cavity

CAVITY	OD1	OD2	N*	K
4	8.25	7.05	10.25	2
6	10.25	9.1	12.25	2
8	12.2	10.85	14.25	2
10	15.05	13.2	17.1	2
12	17.65	15.5	20	2.5

CAVITY	OD1	OD2	N	K
1/8	7.1	6.2	8.6	1.5
5/32*	8.25	7.05	10.25	2
1/4	10.6	9.35	12.65	2
5/16*	12.2	10.85	14.25	2
3/8	10.05	13.1	17.1	2

\*5/32"=4mm and 5/16"=8mm

**WARNING** These products can expose you to chemicals including NICKEL or LEAD, which are known to the state of California to cause cancer, and LEAD which is known to cause birth defects or other reproductive harm. For more information go to [www.P65Warnings.ca.gov](http://www.P65Warnings.ca.gov).



- A
- B
- C
- D
- E
- F
- G
- H
- I
- J
- K
- L
- M
- N
- O

[Click here for CADs, Product Specifications or to Configure Parts Online](#)

# TrueSeal™ Cartridges



## TSC - Cartridge Insert

PART NUMBER WITH EPDM SEAL	NOM. TUBE O.D.	A* DIAMETER ±002	B DIAMETER ±003	C DIAMETER ±003	D DIAMETER MAXIMUM	E DEPTH ±002	F DEPTH ±002	G DEPTH ±002	H* CENTERLINE OF PORTS MINIMUM
ATSC4-MG	1/4	.528	.421	.260	.19	.230	.435	.600	.670
ATSC6-MG	3/8	.632	.545	.385	.31	.280	.455	.705	.790
ATSC8-MG	1/2	.774	.668	.510	.41	.315	.510	.810	1.250

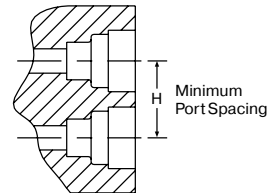
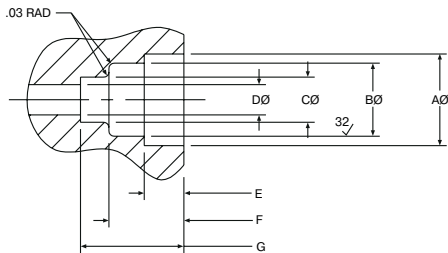

### Parker TrueSeal™ Cartridge Inserts:

Allow you to machine or mold a tube connection into your equipment or components. By using cartridge inserts, you will reduce your material and assembly costs, reduce potential leak paths, and give your equipment a new, clean profile by eliminating the need for threaded connections. TSC Cartridge Inserts consist of 1 o-ring, 1 cartridge, and 1 collet.

\*Cartridge inserts are rated at 150 PSI in ports dimensioned as above and having Noryl as the receiving material. Other materials may have different ratings and require different port dimensions. Consult the Fluid System Connectors Division when using polypropylene, unfilled polypropylene, ABS or Nylon.

### Assembly Instructions:

1. Machine or mold the receiving orifice as per the above dimensions.
2. Place the cartridge insert squarely onto the prepared port opening making sure that the barbs of the cartridge are going into the hole and the lettering on the face of the cartridge is visible.
3. Using a rubber mallet or press, insert the cartridge into the first gland orifice until its face is flush with the top surface of the port.
4. Insert the o-ring into the cartridge and seat it evenly into the second gland orifice.
5. Insert the collet into the cartridge opening.
6. Insert tubing.

**WARNING** These products can expose you to chemicals including NICKEL or LEAD, which are known to the state of California to cause cancer, and LEAD which is known to cause birth defects or other reproductive harm. For more information go to [www.P65Warnings.ca.gov](http://www.P65Warnings.ca.gov).



[Click here for CADs, Product Specifications or to Configure Parts Online](#)

# PLM/PLS Cartridges

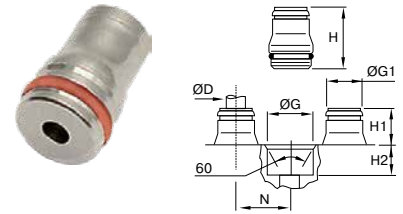
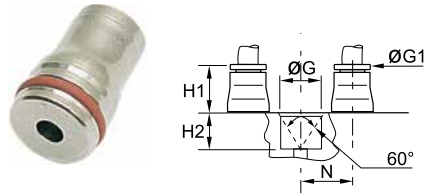

## PLMC Cartridge

PART NO.	TUBE SIZE MM	G + .1 - 0	H1 MM	H2 MM	N MM
PLMC-4M	4	10.00	9.00	8.50	11.00
PLMC-6M	6	12.00	11.00	8.50	13.50
PLMC-8M	8	15.00	12.50	8.50	16.00
PLMC-10M	10	17.50	14.50	10.50	20.00
PLMC-12M	12	19.50	15.00	10.50	22.50
PLMC-14M	14	21.50	16.50	12.00	25.00

## PLSC Cartridge - Metric

PART NO.	TUBE SIZE MM	G + .1 - 0 MM	G1 MM	H MM	H1 MM	H2 MM	N MM
PLSC-4M	4	9.80	8	18.00	9.50	8.50	11.00
PLSC-6M	6	12.10	10	20.00	11.50	8.50	13.50
PLSC-8M	8	14.80	13	22.00	13.50	8.50	16.00
PLSC-10M	10	17.50	15	25.50	15.00	10.50	20.00

**WARNING** These products can expose you to chemicals including NICKEL or LEAD, which are known to the state of California to cause cancer, and LEAD which is known to cause birth defects or other reproductive harm. For more information go to [www.P65Warnings.ca.gov](http://www.P65Warnings.ca.gov).



- A
- B
- C
- D
- E
- F
- G
- H
- I
- J
- K
- L
- M
- N
- O

[Click here for CADs, Product Specifications or to Configure Parts Online](#)

# SAE Encapsulated Cartridges

## PTCCE SAE Encapsulated Cartridge

PART NO.	TUBE SIZE	CAVITY SIZE $\pm .002$	L	M	O.D.	FLOW DIA. D
PTCCE-4	1/4	.504	.63	.43	.56	.13
PTCCE-4-8	1/4	.775	.63	.50	.88	.13
PTCCE-6	3/8	.65	.69	.48	.73	.22
PTCCE-6-8	3/8	.775	.71	.50	.88	.22
PTCCE-8	1/2	.775	.91	.69	.88	.34

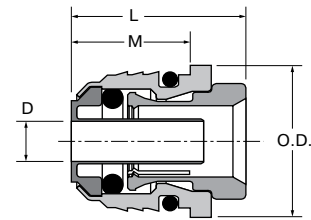

NOMINAL TUBE OD (IN)	D1 (MM) $\pm .05$	D1 (IN) $\pm .002$	L1 (MM) MIN	L1 (IN) MIN	R1 (MM) $\pm .05$	R1 (IN) $\pm .002$	R2 (MM) $\pm .05$	R2 (IN) $\pm .002$	C1 (MM) $\pm .05$	C1 (IN) $\pm .002$
1/4	12.8	.504	12.7	.5	.5	.02	.5	.02	.5	.02
3/8	16.5	.65	16.5	.65	.5	.02	.5	.02	.5	.02
1/2	19.7	.775	19.8	.78	.5	.02	.5	.02	.5	.02
5/8	23.5	.925	22.4	.88	.8	.03	.5	.02	.8	.03

Cavity material is to be 6061 T6 aluminum

### Cavity Specifications

Dimensions are per the SAE Standard J2494-4. The SAE Encapsulated Cartridge is thoroughly tested to meet or exceed the performance requirements of D.O.T. FMVSS 571.106 and SAE J1131 when used in a 6061-T6 aluminum cavity per SAE J2494-4. Cavity dimensions specified by SAE J2494-4 need to be adjusted slightly for optimum performance in material other than 6061-T6.

### Installation

Apply force evenly over the top surface of the cartridge body until the cartridge shoulder bottoms out on the top of the cavity. The amount of force required will vary depending on the cartridge size and the material of the cavity.

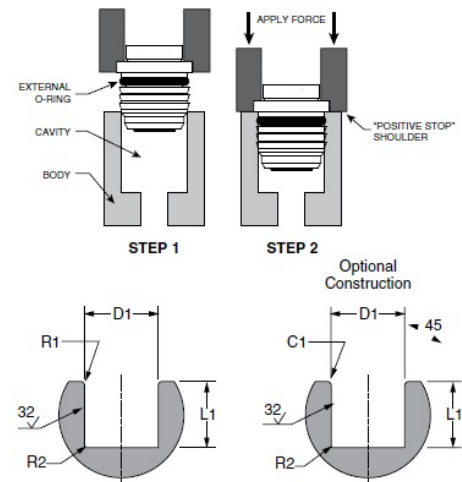

**WARNING** These products can expose you to chemicals including NICKEL or LEAD, which are known to the state of California to cause cancer, and LEAD which is known to cause birth defects or other reproductive harm. For more information go to [www.P65Warnings.ca.gov](http://www.P65Warnings.ca.gov).







# Transportation Push-to-Connect

PTC & PTCR Composite Fittings

PTC Brass Fittings

Metric Prestomatic Fittings

Parker Safe Lock



For more product information visit:  
[www.parker.com/dot](http://www.parker.com/dot)



**Threaded Fittings**

**VS368PTCR**  
Male Y Connector  
NPT  
p. E7



**VS369PTCR**  
Male Elbow  
NPT  
p. E8



**369PTCR**  
Male Elbow Swivel  
90° Metric Straight  
Thread  
p. E8



**370PTCR**  
Female Elbow  
NPT  
p. E8



**VS371PTCR**  
Run Tee  
NPT  
p. E9



**VS372PTCR**  
Branch Tee  
NPT  
p. E9



**377PTCR**  
Female Branch Tee  
NPT  
p. E9



**VS379PTCR**  
45° Male Elbow  
NPT  
p. E10



**379PTCR**  
Male Elbow Swivel  
45° Metric Straight  
Thread  
p. E10



**66PTC**  
Female Connector  
NPT  
p. E13



**68PTC / VS68PTC**  
Male Connector  
NPT  
p. E14



**68PTC**  
Male Connector  
Metric Straight  
Thread  
p. E14



**169PTC**  
Male Elbow  
NPT  
p. E14



**169PTCNSL**  
Male Elbow Long  
Rigid 90° - NPT  
p. E15



**169PTCNS**  
Male Elbow Rigid  
NPT  
p. E15



**169PTCNSL**  
Male Elbow to Metric  
Adjustable  
p. E15



**170PTC**  
Female Elbow  
Swivel - NPT  
p. E15



**170PTCNS**  
Female Elbow  
Rigid - NPT  
p. E15



**171PTC**  
Run Tee Swivel  
NPT  
p. E16



**171PTCNS**  
Run Tee Rigid  
NPT  
p. E16



**172PTC**  
Branch Tee Swivel  
NPT  
p. E16



**172PTCNS**  
Branch Tee Rigid  
NPT  
p. E16



**179PTC**  
45° Male Elbow  
Swivel - NPT  
p. E17



**179PTCNS**  
45° Male Elbow  
Rigid - NPT  
p. E17



**189PTC**  
Dual Port Elbow  
Positional - NPT  
p. E17



**F8UPMTB**  
Male Connector  
p. E21



**C8UPMTB**  
Male Elbow  
p. E21



**S8UPMTB**  
Branch Tee  
p. E21



**F2PMTB**  
Male Connector  
NPT  
p. E21



**Tube to Tube Fittings**

**32PTC**  
Union  
p. E7



**362PTC**  
Union Y  
p. E7



**362PTC**  
Unequal Union Y  
p. E7



**364PTC**  
Union Tee  
p. E7



**365PTC**  
Union Elbow  
p. E7



**62PTC**  
Union  
p. E14



**164PTC**  
Union Tee  
p. E14



**165PTC**  
Union Elbow  
p. E14



**HPMTB**  
Union  
p. E21



**JPMTB**  
Union Tee  
p. E21



**WARNING** These products can expose you to chemicals including NICKEL or LEAD, which are known to the state of California to cause cancer, and LEAD which is known to cause birth defects or other reproductive harm. For more information go to [www.P65Warnings.ca.gov](http://www.P65Warnings.ca.gov).

**Bulkhead Unions**

**62PTCBHR**  
Retaining Ring Bulkhead  
p. E13, E18



**62PTCBH**  
Bulkhead Union  
p. E13, E18



**66PTCBH**  
Bulkhead Female Connector  
p. E13



**68PTCBH**  
Bulkhead Male Connector  
p. E13



**165PTCBH**  
Elbow Union Bulkhead  
p. E18



**169PTCBH**  
Male Elbow Bulkhead  
p. E18



**Plug-In Fittings**

**369PTCSP**  
Male Elbow  
p. E8



**37PTCSP**  
Adapter  
p. E8



**371PTCSP**  
Run Tee  
p. E9



**372PTCSP**  
Branch Tee  
p. E9



**Accessories**

**ERHD**  
External Retainer  
p. E18



**ES**  
External Seal  
p. E18



**639PLP**  
Plug  
p. E19



**AQRT**  
Quick Release Tool  
p. E11, E19



**PTCB**  
Collet Caps  
p. E11, E19



**Manifolds**

**24M**  
Presto Manifold  
p. E11



**Safe Lock Fittings**

**A613, A614**  
Safe Lock Straight  
p. E23



**A623, A624**  
Safe Lock Elbow  
p. E23



**68ALS**  
Brass Adapter  
p. E23



**WARNING** These products can expose you to chemicals including NICKEL or LEAD, which are known to the state of California to cause cancer, and LEAD which is known to cause birth defects or other reproductive harm. For more information go to [www.P65Warnings.ca.gov](http://www.P65Warnings.ca.gov).





# PTC & PTCR Composite Fittings

Parker's PTC & PTCR fittings are composite push-to-connect fittings that meet SAE and D.O.T. specifications. Designed for all D.O.T truck and trailer applications, Parker PTC fittings reduce assembly time versus compression style fittings .

## Product Features:

- Brass Collet
- HNBR O-ring
- Stainless Steel Tube Support or Brass
- Meets D.O.T. FMVSS571.106
- Meets SAE J2494-3
- Composite Body – Strong, Lightweight, Compact and Impact Resistant
- Plug-in configurations

## Markets:

- Heavy Duty Truck
- Trailer
- Mobile

## Applications:

- Air Brakes
- Air Tanks
- Air Ride
- Sliders
- Tire Inflation
- Primary & Secondary Air Lines
- Cab Controls

## Specifications:

**Pressure Range** Up to 250 PSI (17.2 bar)

**Temperature Range** -40° to +200° F (-40° to +93.3° C)

## Compatible Tubing:

- SAE J844 Type A & B nylon tubing

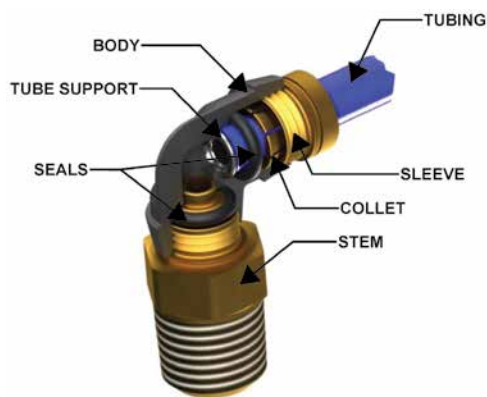

## Assembly Instructions

1. Cut tubing squarely – maximum of 15° angle allowable.
2. Check that port or mating part is clean and free of debris.
3. Mark tubing to appropriate tube insertion length. (see Tube Insertion Chart on page N22)
4. Insert tubing until it bottoms
5. Pull on tubing to verify it is fully inserted
6. To disassemble, simply press release button, hold against body and pull tubing out of fitting.

**WARNING** These products can expose you to chemicals including LEAD which is known to the state of California to cause cancer and birth defects or other reproductive harm. For more information go to [www.P65Warnings.ca.gov](http://www.P65Warnings.ca.gov).



Click here for CADs, Product Specifications or to Configure Parts Online

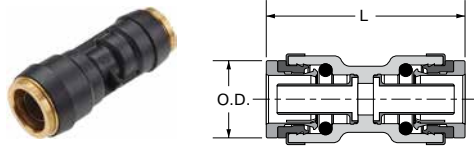

### Union 32PTC

PART NO.	TUBE SIZE	TUBE SIZE 2	L	O.D.
32PTC-4	1/4	1/4	1.33	.55
32PTC-6	3/8	3/8	1.65	.74
32PTC-8	1/2	1/2	1.86	.91
32PTC-10	5/8	5/8	2.15	1.05
32PTC-12	3/4	3/4	2.50	1.21
32PTC-10-12	5/8	3/4	2.91	1.21
32PTC-4-6M	1/4	6MM		.55
32PTC-6-4	3/8	1/4	1.57	.74
32PTC-8-6	1/2	3/8	1.95	.91

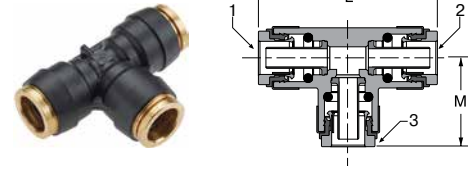

### Union Tee 364PTC

PART NO.	TUBE SIZE 1	TUBE SIZE 2	TUBE SIZE 3	L	M
364PTC-4	1/4	1/4	1/4	1.52	.76
364PTC-6	3/8	3/8	3/8	2.03	1.01
364PTC-8	1/2	1/2	1/2	2.29	1.15
364PTC-10	5/8	5/8	5/8	2.88	1.44
364PTC-6-6-4	3/8	3/8	1/4	2.03	.87
364PTC-6-6-5/32	3/8	3/8	5/32	2.02	1.01
364PTC-4-4-6	1/4	1/4	3/8	1.91	1.01
364PTC-4-6-4	1/4	3/8	1/4	1.77	.87

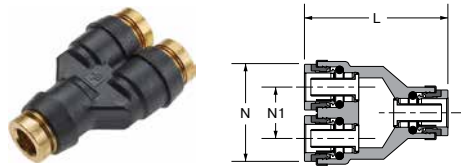

### Union Y 362PTC

PART NO.	TUBE SIZE	L	N	N1
362PTC-4	1/4	1.52	1.06	.50
362PTC-6	3/8	2.03	1.43	.68
362PTC-8	1/2	2.20	1.74	.84



### Union Elbow 365PTC

PART NO.	TUBE SIZE	L
365PTC-4	1/4	.76
365PTC-6	3/8	1.01
365PTC-8	1/2	1.13

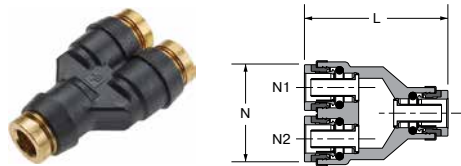

### Unequal Union Y 362PTC

PART NO.	TUBE SIZE	L	N	N1	N2
362PTC-4-6	3/8	1.97	1.43	1/4	1/4
362PTC-4-6-6	3/8	2.03	1.43	1/4	3/8
362PTC-4-6-8	1/2	2.14	1.43	1/4	3/8
362PTC-6-4	1/4	2.10	1.43	3/8	3/8
362PTC-6-8-8	1/2	2.20	1.75	1/2	3/8
362PTC-8-4-8	1/2	2.20	1.74	1/2	1/4

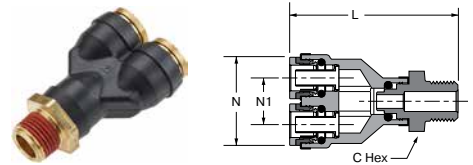

### Union Y Male Connector VS368PTCR

PART NO.	TUBE SIZE	PIPE THREAD	L	C HEX	N	N1
VS368PTCR-4-2	1/4	1/8	1.96	9/16	1.03	.50
VS368PTCR-4-4	1/4	1/4	2.12	9/16	1.03	.50
VS368PTCR-6-4	3/8	1/4	2.56	3/4	1.41	.68

**WARNING** These products can expose you to chemicals including LEAD which is known to the state of California to cause cancer and birth defects or other reproductive harm. For more information go to [www.P65Warnings.ca.gov](http://www.P65Warnings.ca.gov).



[Click here for CADs, Product Specifications or to Configure Parts Online](#)

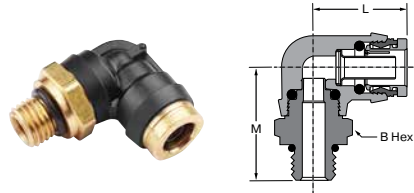

### Male Elbow Swivel 90° Metric Straight Thread 369PTCR

PART NO.	TUBE SIZE	THREAD*	B HEX	L	M
369PTCR-4-MA12	1/4	M12X1.5	11/16	0.74	1.13
369PTCR-4-MA16	1/4	M16X1.5	7/8	0.74	1.16
369PTCR-4-MA22	1/4	M22X1.5	1 1/16	0.74	1.28
369PTCR-6-MA12	3/8	M12X1.5	3/4	1.01	1.22
369PTCR-6-MA16	3/8	M16X1.5	7/8	1.01	1.29
369PTCR-6-MA22	3/8	M22X1.5	1 1/16	1.01	1.28
369PTCR-8-MA12	1/2	M12X1.5	15/16	1.13	1.39
369PTCR-8-MA16	1/2	M16X1.5	15/16	1.13	1.41
369PTCR-8-MA22	1/2	M22X1.5	1 1/16	1.13	1.4
369PTCR-10-MA12	5/8	M12X1.5	1 1/16	1.36	1.63
369PTCR-10-MA16	5/8	M16X1.5	1 1/16	1.36	1.58
369PTCR-10-MA22	5/8	M22X1.5	1 1/16	1.36	1.57
369PTCR-12-MA22	3/4	M22X1.5	1 3/16	1.47	1.84

\*Per ISO 4039

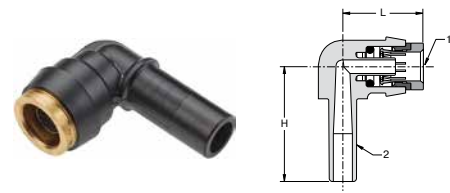

### Plug-In Elbow 369PTCSP

PART NO.	TUBE SIZE 1	TUBE SIZE 2	H	L
369PTCSP-4-4	1/4	1/4	1.06	.74
369PTCSP-4-6	1/4	3/8	1.20	.74
369PTCSP-6-4	3/8	1/4	1.18	.96
369PTCSP-6-6	3/8	3/8	1.32	0.96
369PTCSP-6-8	3/8	1/2	1.52	.96
369PTCSP-8-4	1/2	1/4	1.16	1.12
369PTCSP-8-6	1/2	3/8	1.30	1.12
369PTCSP-8-8	1/2	1/2	1.50	1.12
369PTCSP-10-8	5/8	1/2	1.57	1.36
369PTC-10-10	5/8	5/8	1.75	1.36

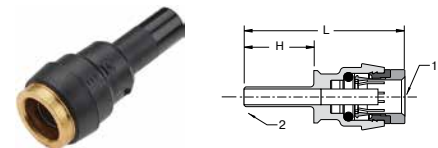

### Plug-In Adapter 37PTCSP

PART NO.	TUBE SIZE 1	TUBE SIZE 2	H	L
37PTCSP-4-6	1/4	3/8	.90	1.71
37PTCSP-6-4	3/8	1/4	.76	1.66
37PTCSP-10-8	5/8	1/2	1.10	2.44

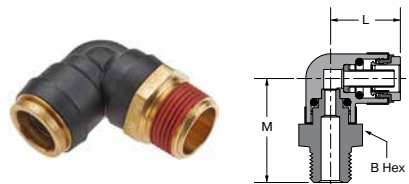

### Male Elbow Swivel 90° VS369PTCR

PART NO.	TUBE SIZE	PIPE THREAD	B HEX	L	M
VS369PTCR-4-2	1/4	1/8	9/16	.74	1.00
VS369PTCR-4-4	1/4	1/4	9/16	.74	1.14
VS369PTCR-4-6	1/4	3/8	11/16	.74	1.14
VS369PTCR-4-8	1/4	1/2	7/8	.74	1.35
VS369PTCR-6-2	3/8	1/8	3/4	1.01	1.24
VS369PTCR-6-4	3/8	1/4	3/4	1.01	1.45
VS369PTCR-6-6	3/8	3/8	3/4	1.01	1.28
VS369PTCR-6-8	3/8	1/2	7/8	1.01	1.49
VS369PTCR-8-4	1/2	1/4	15/16	1.13	1.42
VS369PTCR-8-6	1/2	3/8	15/16	1.13	1.42
VS369PTCR-8-8	1/2	1/2	15/16	1.13	1.61
VS369PTCR-10-6	5/8	3/8	1-1/16	1.36	1.61
VS369PTCR-10-8	5/8	1/2	1-1/16	1.36	1.80
VS369PTCR-12-8	3/4	1/2	1-3/16	1.47	1.91
VS369PTCR-12-12	3/4	3/4	1-3/16	1.47	1.87

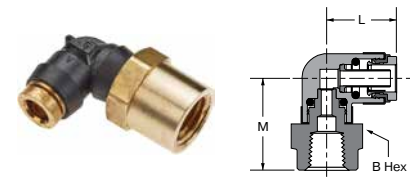

### Female Elbow Swivel 90° 370PTCR

PART NO.	TUBE SIZE	PIPE THREAD	B HEX	L	M
370PTCR-4-2	1/4	1/8	9/16	.74	.94
370PTCR-4-4	1/4	1/4	11/16	.74	1.20
370PTCR-6-2	3/8	1/8	3/4	1.01	.75
370PTCR-6-4	3/8	1/4	3/4	1.01	1.04
370PTCR-6-6	3/8	3/8	3/4	1.01	1.19
370PTCR-8-6	1/2	3/8	3/4	1.13	1.24
370PTCR-8-8	1/2	1/2	15/16	1.13	1.49

**WARNING** These products can expose you to chemicals including LEAD which is known to the state of California to cause cancer and birth defects or other reproductive harm. For more information go to [www.P65Warnings.ca.gov](http://www.P65Warnings.ca.gov).



[Click here for CADs, Product Specifications or to Configure Parts Online](#)

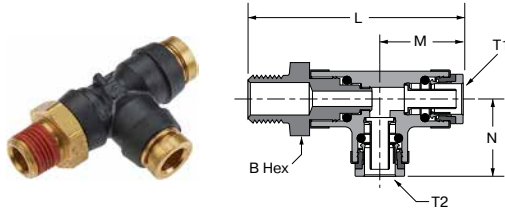

**Male Run Tee Swivel VS371PTCR**

PART NO.	TUBE SIZE 1	TUBE SIZE 2	PIPE THREAD	B HEX	L	M	N
VS371PTCR-4-2	1/4	1/4	1/8	9/16	1.80	.76	.76
VS371PTCR-4-4	1/4	1/4	1/4	9/16	1.94	.76	.76
VS371PTCR-6-4	3/8	3/8	1/4	3/4	2.25	1.01	1.01
VS371PTCR-6-6	3/8	3/8	3/8	3/4	2.25	1.01	1.01
VS371PTCR-8-4	1/2	1/2	1/4	15/16	2.59	1.15	1.15
VS371PTCR-8-6	1/2	1/2	3/8	15/16	2.59	1.15	1.15
VS371PTCR-8-8	1/2	1/2	1/2	15/16	2.78	1.15	1.15
371PTCR-4-6	1/4	1/4	3/8	11/16	1.94	.76	.76
371PTCR-8-4-8	1/2	1/4	1/2	15/16	2.78	1.15	1.23
371PTCR-4-6-4	1/4	3/8	1/4	3/4	2.25	1.01	.96

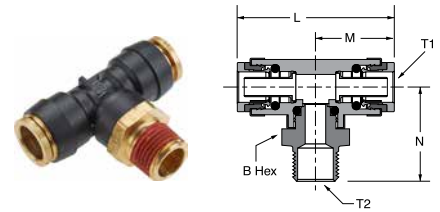

**Male Branch Tee Swivel VS372PTCR**

PART NO.	TUBE SIZE	PIPE THREAD	B HEX	L	M	N
VS372PTCR-4-2	1/4	1/8	1/8	1.52	.75	1.04
VS372PTCR-4-4	1/4	1/4	9/16	1.52	.76	1.18
VS372PTCR-4-6	1/4	3/8	11/16	1.52	.76	1.18
VS372PTCR-6-2	3/8	1/8	3/4	2.03	1.01	1.16
VS372PTCR-6-4	3/8	1/4	1/4	2.03	1.01	1.27
VS372PTCR-6-6	3/8	3/8	3/4	2.02	1.01	1.27
VS372PTCR-6-8	3/8	1/2	7/8	2.03	1.01	1.45
VS372PTCR-8-4	1/2	1/4	1/4	2.30	1.15	1.42
VS372PTCR-8-6	1/2	3/8	3/8	2.30	1.15	1.42
VS372PTCR-8-8	1/2	1/2	1/2	2.30	1.15	1.61
VS372PTCR-10-8	5/8	1/2	1 1/16	2.88	1.44	1.80
VS372PTCR-4-6-4	1/4-3/8	1/4	3/4	1.91	.90/1.01	1.23
VS372PTCR-6-4-6	3/8-1/4	3/8	3/4	1.91	.90/1.01	1.23
VS372PTCR-6-8-8	3/8-1/2	1/2	15/16	2.38	1.15	1.61

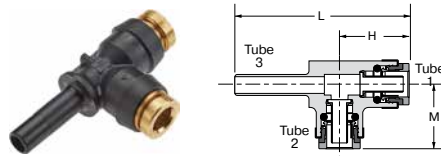

**Plug-In Run Tee 371PTCSP**

PART NO.	TUBE SIZE 1	TUBE SIZE 2	TUBE SIZE 3	H	L	M
371PTCSP-4-4	1/4	1/4	1/4	.78	1.84	.76
371PTCSP-4-6	1/4	1/4	3/8	.78	1.98	.76
371PTCSP-6-4	3/8	3/8	1/4	1.01	2.11	1.01
371PTCSP-6-6	3/8	3/8	3/8	1.01	2.25	1.01
371PTCSP-6-4-6	3/8	1/4	3/8	0.76	2.24	1.01
371PTCSP-8-4-8	1/2	1/4	1/2	0.96	2.58	1.15

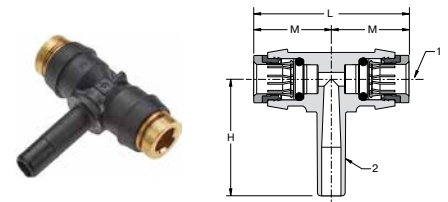

**Plug-In Branch Tee 372PTCSP**

PART NO.	TUBE SIZE 1	TUBE SIZE 2	H	L	M
372PTCSP-4-4	1/4	1/4	1.05	1.48	.74
372PTCSP-4-6	1/4	3/8	1.19	1.48	.74
372PTCSP-6-4	3/8	1/4	1.18	2.02	1.01
372PTCSP-6-6	3/8	3/8	1.32	2.02	1.01

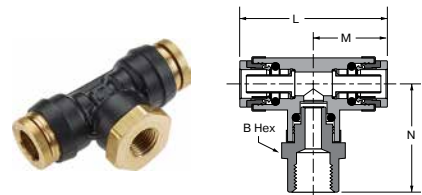

**Female Branch Tee Swivel 377PTCR**

PART NO.	TUBE SIZE	PIPE THREAD	B HEX	L	M	N
377PTCR-4-4	1/4	1/4	3/4	1.48	.74	1.27
377PTCR-6-2	3/8	1/8	3/4	2.03	1.01	.78
377PTCR-6-4	3/8	1/4	3/4	2.03	1.01	1.07
377PTCR-10-4	5/8	1/4	1 1/16	2.88	1.44	1.23

**WARNING** These products can expose you to chemicals including LEAD which is known to the state of California to cause cancer and birth defects or other reproductive harm. For more information go to [www.P65Warnings.ca.gov](http://www.P65Warnings.ca.gov).

- A
- B
- C
- D
- E
- F
- G
- H
- I
- J
- K
- L
- M
- N
- O

[Click here for CADs, Product Specifications or to Configure Parts Online](#)

- A
- B
- C
- D
- E
- F
- G
- H
- I
- J
- K
- L
- M
- N
- O

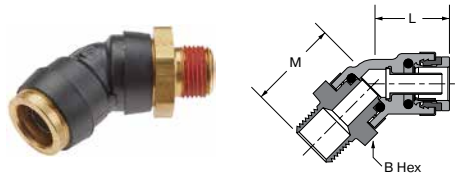

**Male Elbow Swivel 45° VS379PTCR**

PART NO.	TUBE SIZE	PIPE THREAD	B HEX	L	M
VS379PTCR-4-2	1/4	1/8	9/16	.68	.91
VS379PTCR-4-4	1/4	1/4	9/16	.68	1.05
VS379PTCR-4-6	1/4	3/8	9/16	.68	1.05
VS379PTCR-6-2	3/8	1/8	3/4	.89	.97
VS379PTCR-6-4	3/8	1/4	3/4	.89	1.10
VS379PTCR-6-6	3/8	3/8	3/4	.89	1.11
VS379PTCR-6-8	3/8	1/2	7/8	.89	1.32
VS379PTCR-8-4	1/2	1/4	15/16	1.03	1.22
VS379PTCR-8-6	1/2	3/8	15/16	1.03	1.24
VS379PTCR-8-8	1/2	1/2	15/16	1.03	1.41
VS379PTCR-10-6	5/8	3/8	1-1/16	1.21	1.43
VS379PTCR-10-8	5/8	1/2	1-1/16	1.21	1.62
VS379PTCR-12-8	3/4	1/2	1-3/16	1.29	1.72

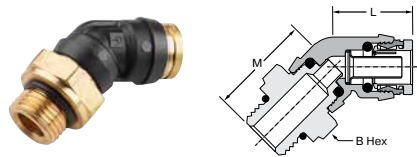

**Male Elbow Swivel 45° Metric Straight Thread 379PTCR**

PART NO.	TUBE SIZE	THREAD*	B HEX	L	M
379PTCR-4-MA12	1/4	M12 X 1.5	1 1/16	0.68	1.05
379PTCR-4-MA16	1/4	M16 X 1.5	7/8	0.68	1.07
379PTCR-4-MA22	1/4	M22 X 1.5	1 1/16	0.68	1.19
379PTCR-6-MA12	3/8	M12 X 1.5	3/4	0.89	1.09
379PTCR-6-MA16	3/8	M16 X 1.5	7/8	0.89	1.16
379PTCR-6-MA22	3/8	M22 X 1.5	1 1/16	0.89	1.16
379PTCR-8-MA12	1/2	M12 X 1.5	15/16	1.03	1.21
379PTCR-8-MA16	1/2	M16 X 1.5	15/16	1.03	1.21
379PTCR-8-MA22	1/2	M22 X 1.5	1 1/16	1.03	1.21
379PTCR-10-MA12	5/8	M12 X 1.5	1 1/16	1.21	1.45
379PTCR-10-MA16	5/8	M16 X 1.5	1 1/16	1.21	1.4
379PTCR-10-MA22	5/8	M22 X 1.5	1 1/16	1.21	1.4

\*Per ISO 4039



**Presto Manifold 24M**

PART NO.	TUBE O.D. INLET	TUBE O.D. OUTLET	A	B	D	G	H	M	M1	N
24M-4-4	1/4	1/4	1.33	4.15	.21	2.75	.53	.90	.88	.89
24M-6-4	3/8	1/4	1.33	3.99	.21	2.75	.53	.90	.88	.89
24M-6-6	3/8	3/8	1.65	6.49	.22	4.55	.60	1.02	1.02	1.33
24M-8-8	1/2	1/2	1.65	6.49	.22	4.55	.60	1.02	1.02	1.33
24M-8-6446	1/2	3/8-1/4	1.65	6.51	.22	4.55	.64	1.02	1.02	1.17

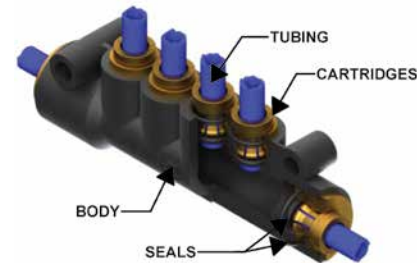
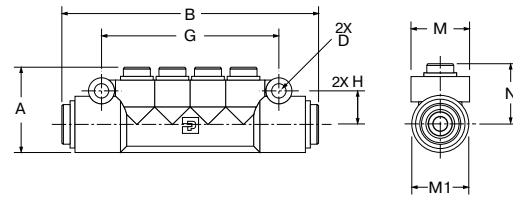

**Assembly Instructions**

1. Cut tubing squarely with Parker tube cutter PTC-001. Be certain that Manifold ports are clean and free of debris.
2. Insert tubing into port until it bottoms. Pull on tubing to verify that it is properly retained in the manifold.
3. To disassemble, simply hold release button against the manifold body and remove the tubing.
4. To reassemble, make certain that the Manifold ports are clean and free of debris and lubricate leading end of the tubing with light oil or petroleum jelly.

**WARNING** These products can expose you to chemicals including LEAD which is known to the state of California to cause cancer and birth defects or other reproductive harm. For more information go to [www.P65Warnings.ca.gov](http://www.P65Warnings.ca.gov).

[Click here for CADs, Product Specifications or to Configure Parts Online](#)



**AQRT - Quick Release Tool**

Makes disconnection of tube adapters and tubing a breeze.



**PTCB Collet Caps**

	TUBE O.D.			
	1/4	3/8	1/2	5/8
<b>WHITE PART NO.</b>	4-PTCB-W	6-PTCB-W	8-PTCB-W	10-PTCB-W
<b>BLACK PART NO.</b>	4-PTCB-BL	6-PTCB-BL	8-PTCB-BL	10-PTCB-BL
<b>GREEN PART NO.</b>	4-PTCB-G	6-PTCB-G	8-PTCB-G	10-PTCB-G
<b>RED PART NO.</b>	4-PTCB-R	6-PTCB-R	8-PTCB-R	10-PTCB-R
<b>BLUE PART NO.</b>	4-PTCB-BU	6-PTCB-BU	8-PTCB-BU	
<b>YELLOW PART NO.</b>	4-PTCB-Y	6-PTCB-Y	8-PTCB-Y	10-PTCB-Y
<b>BROWN PART NO.</b>	4-PTCB-BR	6-PTCB-BR	8-PTCB-BR	10-PTCB-BR
<b>GREY PART NO.</b>	4-PTCB-GR	6-PTCB-GR	8-PTCB-GR	10-PTCB-GR
<b>ORANGE PART NO.</b>	4-PTCB-O	6-PTCB-O	8-PTCB-O	10-PTCB-O
<b>PURPLE PART NO.</b>	4-PTCB-PU	6-PTCB-PU	8-PTCB-PU	10-PTCB-PU
<b>DARK PURPLE PART NO.</b>	4-PTCB-DPU	6-PTCB-DPU	8-PTCB-DPU	10-PTCB-DPU

- A
- B
- C
- D
- E
- F
- G
- H
- I
- J
- K
- L
- M
- N
- O

**WARNING** These products can expose you to chemicals including LEAD which is known to the state of California to cause cancer and birth defects or other reproductive harm. For more information go to [www.P65Warnings.ca.gov](http://www.P65Warnings.ca.gov).



A  
B  
C  
D  
E  
F  
G  
H  
I  
J  
K  
L  
M  
N  
O



# PTC Brass Fittings

Parker's PTC Brass Fittings are robust, all brass push-to-connect fittings that meet SAE and D.O.T. specifications. Designed for all D.O.T truck and trailer applications, Parker PTC Brass fittings reduce assembly time versus compression style fittings by 90%.

### Product Features:

- Brass Collet
- Buna N O-ring
- Stainless Steel Tube Support
- Meets D.O.T. FMVSS571.106
- Meets SAE J2494 & SAE J2494-3

### Markets:

- Heavy Duty Truck
- Trailer
- Mobile

### Applications:

- Air Brakes
- Air Tanks
- Air Ride
- Sliders
- Tire Inflation
- Primary & Secondary Air Lines

### Specifications:

**Pressure Range** Up to 250 PSI (17.2 bar)

**Temperature Range** -40° to +200° F (-40° to +93.3° C)

### Compatible Tubing:

- SAE J844 Type A & B nylon tubing

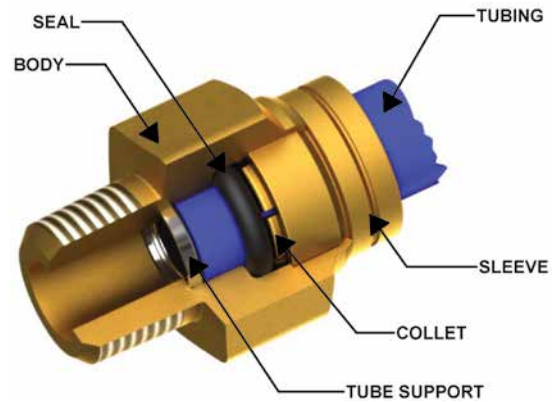

### Assembly Instructions

1. Cut tubing squarely – maximum of 15° angle allowable.
2. Check that port or mating part is clean and free of debris.
3. Mark tubing to appropriate tube insertion length. (see Tube Insertion Chart on page N22)
4. Insert tubing until it bottoms
5. Pull on tubing to verify it is fully inserted
6. To disassemble, simply press release button, hold against body and pull tubing out of fitting.



**Note:**  
5/32 and 3/16 units have black button



**Note:**  
Use VS prefix to order with Vibra Seal

**WARNING** These products can expose you to chemicals including NICKEL or LEAD, which are known to the state of California to cause cancer, and LEAD which is known to cause birth defects or other reproductive harm. For more information go to [www.P65Warnings.ca.gov](http://www.P65Warnings.ca.gov).

Click here for CADs, Product Specifications or to Configure Parts Online

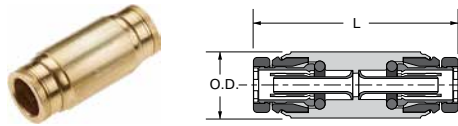

### Union 62PTC

PART NO.	TUBE SIZE	TUBE SIZE 2	L	O.D.
62PTC-5/32*	5/32	5/32	1.35	.41
62PTC-3*	3/16	3/16	1.36	.44
62PTC-4	1/4	1/4	1.37	1/2
62PTC-6	3/8	3/8	1.77	3/4
62PTC-6-4	3/8	1/4	1.57	3/4
62PTC-4-5/32	1/4	5/32		
62PTC-8	1/2	1/2	1.92	7/8
62PTC-10	5/8	5/8	2.32	1

\*5/32 and 3/16 with black button

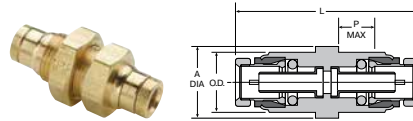

### Bulkhead Union 62PTCBH

PART NO.	TUBE SIZE (IN)	OD (IN)	L (IN)	P MAX (IN)	HEX A (IN)	HEX B (IN)	BULKHEAD HOLE DIA. (IN)
62PTCBH-4	1/4	.56	1.69	.25	11/16	3/4	9/16
62PTCBH-6	3/8	.88	1.93	.44	1 1/16	1 1/16	7/8
62PTCBH-8	1/2	1.00	2.02	.58	1 1/4	1 1/4	1
62PTCBH-10	5/8	1.12	2.40	.81	1 1/4	1 3/8	1-1/8

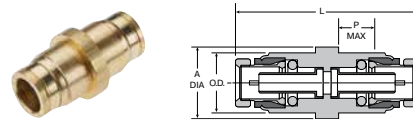

### Retaining Ring Bulkhead Union 62PTCBHR

PART NO.	TUBE SIZE (IN)	OD (IN)	REC. HOLE SIZE (IN)	L (IN)	P. MAX (IN)	A DIA (IN)
62PTCBHR-4	1/4	.500	.512	1.53	.26	.625
62PTCBHR-6	3/8	.750	.762	1.92	.36	.875
62PTCBHR-8	1/2	.875	.887	2.15	.43	1.000
62PTCBHR-10	5/8	1.000	1.012	2.32	.48	1.250

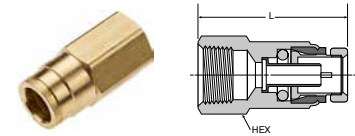

### Female Connector 66PTC

PART NO.	TUBE SIZE	PIPE THREAD	L	HEX
66PTC-5/32-2*	5/32	1/8	1.16	9/16
66PTC-5/32-4*	5/32	1/4	1.33	11/16
66PTC-3-2*	3/16	1/8	1.17	9/16
66PTC-4-2	1/4	1/8	9/16	1.17
66PTC-4-4	1/4	1/4	11/16	1.37
66PTC-4-6	1/4	3/8		
66PTC-6-2	3/8	1/8	3/4	1.38
66PTC-6-4	3/8	1/4	3/4	1.59
66PTC-6-6	3/8	3/8	3/4	1.59
66PTC-8-4	1/2	1/4	7/8	1.61
66PTC-8-6	1/2	3/8	15/16	1.87
66PTC-8-8	1/2	1/2	15/16	1.87
66PTC-10-6	5/8	3/8		
66PTC-10-8	5/8	1/2		

\*5/32 and 3/16 with black button

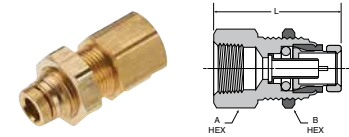

### Bulkhead Female Connector 66PTCBH

PART NO.	TUBE SIZE (IN)	PIPE THREAD (IN)	L (IN)	HEX A (IN)	HEX B (IN)	BULKHEAD HOLE DIA. (IN)
66PTCBH-4-4	1/4	1/4	1.62	11/16	3/4	9/16
66PTCBH-6-6	3/8	3/8	1.87	1.06	1.06	7/8
66PTCBH-8-8	1/2	1/2	2.02	1 1/4	1 1/4	1

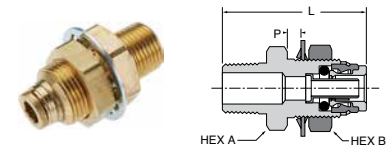

### Bulkhead Male Connector 68PTCBH

PART NO.	TUBE SIZE (IN)	PIPE THREAD (IN)	L (IN)	P MAX (IN)	HEX A (IN)	HEX B (IN)	BULKHEAD HOLE DIA. (IN)
68PTCBH-6-8	3/8	1/2	2.37	.33	1 1/4	1 1/4	1
68PTCBH-8-8	1/2	1/2	2.38	.33	1 1/4	1 1/4	1

**WARNING** These products can expose you to chemicals including NICKEL or LEAD, which are known to the state of California to cause cancer, and LEAD which is known to cause birth defects or other reproductive harm. For more information go to [www.P65Warnings.ca.gov](http://www.P65Warnings.ca.gov).

- A
- B
- C
- D
- E
- F
- G
- H
- I
- J
- K
- L
- M
- N
- O

Click here for CADs, Product Specifications or to Configure Parts Online

\*5/32 and 3/16 with black button

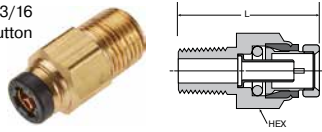

### Male Connector 68PTC

PART NO.	TUBE SIZE	PIPE THREAD	HEX	L
68PTC-5/32-1*	5/32	1/16	7/16	.84
68PTC-5/32-2*	5/32	1/8	7/16	.92
68PTC-5/32-4*	5/32	1/4	9/16	1.02
68PTC-3-1*	3/16	1/16	7/16	.93
68PTC-3-2*	3/16	1/8	7/16	.85
68PTC-3-4*	3/16	1/4	9/16	1.02
68PTC-4-2	1/4	1/8	1/2	.98
68PTC-4-4	1/4	1/4	9/16	1.02
68PTC-4-6	1/4	3/8	11/16	.93
68PTC-4-8	1/4	1/2	7/8	1.12
68PTC-6-2	3/8	1/8	11/16	1.29
68PTC-6-4	3/8	1/4	11/16	1.44
68PTC-6-6	3/8	3/8	11/16	1.44
68PTC-6-8	3/8	1/2	7/8	1.63
68PTC-8-4	1/2	1/4	7/8	1.51
68PTC-8-6	1/2	3/8	7/8	1.63
68PTC-8-8	1/2	1/2	7/8	1.46
68PTC-10-6	5/8	3/8	1	1.74
68PTC-10-8	5/8	1/2	1	1.81
68PTC-12-8	3/4	1/2	1 1/8	1.89
68PTC-12-12	3/4	3/4	1/4	1.89

\*5/32 and 3/16 with black button  
 \*\*Add VS prefix to order with Vibra Seal

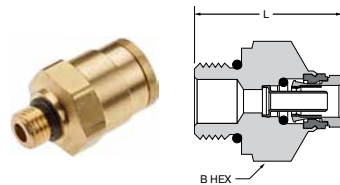

### Male Connector Metric Straight Thread 68PTC

PART NO.	TUBE SIZE	THREAD*	B HEX	L
68PTC-4-MA12	1/4	MA12	11/16	1.14
68PTC-4-MA16	1/4	MA16	7/8	1.21
68PTC-4-MA22	1/4	MA22	1 1/16	1.21
68PTC-6-MA12	3/8	MA12	3/4	1.31
68PTC-6-MA16	3/8	MA16	7/8	1.23
68PTC-6-MA22	3/8	MA22	1 1/16	0.74
68PTC-8-MA12	1/2	MA12	7/8	1.37
68PTC-8-MA16	1/2	MA16	7/8	1.39
68PTC-8-MA22	1/2	MA22	1 1/16	0.91
68PTC-10-MA12	5/8	MA12	1	1.67
68PTC-10-MA16	5/8	MA16	1	1.61
68PTC-10-MA22	5/8	MA22	1 1/16	1.37

\*Per ISO 4039

\*5/32 and 3/16 with black button



### Union Tee 164PTC

PART NO.	TUBE 1 SIZE	TUBE 2 SIZE	L1	L2
164PTC-5/32*	5/32	5/32	.77	.77
164PTC-3*	3/16	3/16	.77	.77
164PTC-4	1/4	1/4	.85	.85
164PTC-6	3/8	3/8	.81	.81
164PTC-6-6-4	3/8	1/4	1.10	.90
164PTC-8	1/2	1/2	1.31	1.31
164PTC-10	5/8	5/8	1.57	1.57

\*5/32 and 3/16 with black button



### Union Elbow 165PTC

PART NO.	TUBE SIZE	L
165PTC-5/32*	5/32	.79
165PTC-3*	3/16	.77
165PTC-4	1/4	.80
165PTC-6	3/8	1.20
165PTC-8	1/2	1.22
165PTC-10	5/8	1.49

\*5/32 and 3/16 with black button

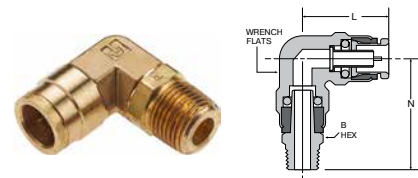

### Male Elbow 90° 169PTC

PART NO.	TUBE SIZE	PIPE THREAD	L	N	WRENCH FLATS	B HEX
169PTC-4-2	1/4	1/8	.85	.96	1/2	9/16
169PTC-4-4	1/4	1/4	.85	1.22	1/2	9/16
169PTC-4-6	1/4	3/8	.85	1.22	1/2	11/16
169PTC-6-2	3/8	1/8	1.02	1.21	9/16	11/16
169PTC-6-4	3/8	1/4	1.02	1.33	9/16	11/16
169PTC-6-6	3/8	3/8	1.02	1.33	9/16	11/16
169PTC-6-8	3/8	1/2	1.02	1.33	9/16	7/8
169PTC-8-4	1/2	1/4	1.16	1.40	11/16	11/16
169PTC-8-6	1/2	3/8	1.16	1.42	11/16	11/16
169PTC-8-8	1/2	1/2	1.16	1.63	11/16	7/8
169PTC-10-6	5/8	3/8	1.47	1.41	7/8	7/8
169PTC-10-8	5/8	1/2	1.47	1.6	7/8	7/8

\*Add VS prefix to order with Vibra Seal

**WARNING** These products can expose you to chemicals including NICKEL or LEAD, which are known to the state of California to cause cancer, and LEAD which is known to cause birth defects or other reproductive harm. For more information go to [www.P65Warnings.ca.gov](http://www.P65Warnings.ca.gov).



Click here for CADs, Product Specifications or to Configure Parts Online

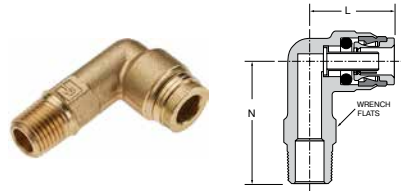

### Male Elbow Long Rigid 90° 169PTCNSL

PART NO.	TUBE SIZE	PIPE THREAD	L	N	WRENCH FLATS
169PTCNSL-6-4	3/8	1/4	1.01	1.63	9/16
169PTCNSL-6-8	3/8	1/2	1.19	2.50	7/8
169PTCNSL-6-6	3/8	3/8	1.19	2.50	7/8
169PTCNSL-8-8	1/2	1/2	1.22	2.50	7/8

\*Add VS prefix to order with Vibra Seal

\*5/32 and 3/16 with black button



### Male Elbow Rigid 90° 169PTCNS

PART NO.	TUBE SIZE	PIPE THREAD	L	N	WRENCH FLATS
169PTCNS-5/32-1*	5/32	1/16	.79	.62	.40
169PTCNS-5/32-2*	5/32	1/8	.84	.65	.40
169PTCNS-5/32-4*	5/32	1/4	.76	.85	.50
169PTCNS-3-2*	3/16	1/8	.77	.65	.40
169PTCNS-3-4*	3/16	1/4	.77	.85	.50
169PTCNS-4-2	1/4	1/8	.84	.72	1/2
169PTCNS-4-4	1/4	1/4	.85	.90	1/2
169PTCNS-4-6	1/4	3/8	.85	1.06	1/2
169PTCNS-6-2	3/8	1/8	1.05	.75	9/16
169PTCNS-6-4	3/8	1/4	1.05	.94	9/16
169PTCNS-6-6	3/8	3/8	1.02	.94	9/16
169PTCNS-6-8	3/8	1/2	1.06	1.26	11/16
169PTCNS-8-4	1/2	1/4	1.16	1.06	11/16
169PTCNS-8-6	1/2	3/8	1.16	1.06	11/16
169PTCNS-8-8	1/2	1/2	1.16	1.26	11/16
169PTCNS-10-6	5/8	3/8	1.49	1.05	7/8
169PTCNS-10-8	5/8	1/2	1.48	1.24	7/8
169PTCNS-12-8	3/4	1/2	1.61	1.44	1
169PTCNS-12-12	3/4	3/4	1.61	1.50	1
169PTCNS-12-12	3/4	3/4			

\*5/32 and 3/16 with black button

\*\*Add VS prefix to order with Vibra Seal

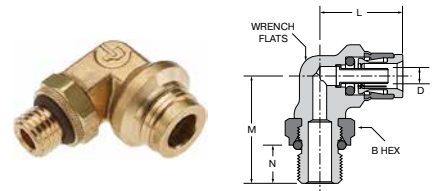

### Male Elbow to Metric Adjustable 169PTCNSL

PART NO.	TUBE SIZE	METRIC THREAD	WRENCH FLATS (MM)	HEX (MM)	L	M	N
169PTCNSL-4-M12	1/4	M12X1.5	10	17	.84	1.11	.37
169PTCNSL-4-M16	1/4	M16X1.5	11	24	.88	1.27	.34
169PTCNSL-4-M22	1/4	M22X1.5	19	30	.94	1.48	.37
169PTCNSL-6-M12	3/8	M12X1.5	16	17	1.00	1.15	.37
169PTCNSL-6-M16	3/8	M16X1.5	19	24	1.18	1.27	.37
169PTCNSL-8-M12	1/2	M12X1.5	16	17	1.21	1.31	.37
169PTCNSL-8-M16	1/2	M16X1.5	16	24	1.20	1.28	.41
169PTCNSL-8-M22	1/2	M22X1.5	19	30	1.20	1.48	.41



### Female Elbow Swivel 90° 170PTC

PART NO.	TUBE SIZE	PIPE THREAD	L	N	HEX	WRENCH FLATS
170PTC-4-2	1/4	1/8	.85	1.06	9/16	1/4

\*Add VS prefix to order with Vibra Seal

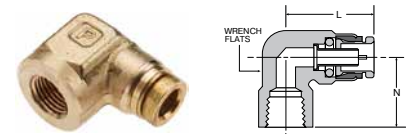

### Female Elbow Rigid 90° 170PTCNS

PART NO.	TUBE SIZE	PIPE THREAD	L	N	WRENCH FLATS
170PTCNS-4-2	1/4	1/8	.84	.56	11/16
170PTCNS-4-4	1/4	1/4	.91	.67	11/16
170PTCNS-6-2	3/8	1/8	1.07	.51	9/16
170PTCNS-6-4	3/8	1/4	1.07	.84	9/16
170PTCNS-6-6	3/8	3/8	1.24	.69	7/8
170PTCNS-8-4	1/2	1/4	1.25	.75	11/16
170PTCNS-8-6	1/2	3/8	1.36	.80	11/16
170PTCNS-8-8	1/2	1/2	1.63	.97	1
170PTCNS-5/32-2	5/32	1/8			

**WARNING** These products can expose you to chemicals including NICKEL or LEAD, which are known to the state of California to cause cancer, and LEAD which is known to cause birth defects or other reproductive harm. For more information go to [www.P65Warnings.ca.gov](http://www.P65Warnings.ca.gov).



Click here for CADs, Product Specifications or to Configure Parts Online

- A
- B
- C
- D
- E
- F
- G
- H
- I
- J
- K
- L
- M
- N
- O

### Male Run Tee Swivel 171PTC

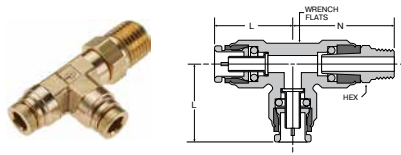

PART NO.	TUBE SIZE	PIPE THREAD	L	N	HEX	WRENCH FLATS
171PTC-4-2	1/4	1/8	.82	1.01	9/16	1/2
171PTC-4-4	1/4	1/4	.82	1.23	9/16	1/2
171PTC-4-6	1/4	3/8	.82	1.23	11/16	1/2
171PTC-6-4	3/8	1/4	1.10	1.35	11/16	5/8
171PTC-6-6	3/8	3/8	1.10	1.38	11/16	5/8
171PTC-8-4	1/2	1/4	1.31	1.45	11/16	3/4
171PTC-8-6	1/2	3/8	1.31	1.48	11/16	3/4
171PTC-8-8	1/2	1/2	1.31	1.69	7/8	3/4

\*Add VS prefix to order with Vibra Seal

### Male Branch Tee Swivel 172PTC

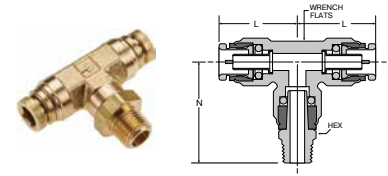

PART NO.	TUBE SIZE	PIPE THREAD	L	N	HEX	WRENCH FLATS
172PTC-4-2	1/4	1/8	.82	1.02	9/16	1/2
172PTC-4-4	1/4	1/4	.82	1.23	9/16	1/2
172PTC-6-2	3/8	1/8	1.10	1.34	11/16	5/8
172PTC-6-4	3/8	1/4	1.10	1.45	11/16	5/8
172PTC-6-6	3/8	3/8	1.10	1.48	11/16	5/8
172PTC-8-4	1/2	1/4	1.31	1.45	5/8	3/4
172PTC-8-6	1/2	3/8	1.31	1.48	11/16	3/4
172PTC-8-8	1/2	1/2	1.31	1.97	7/8	3/4

\*5/32 and 3/16 with black button

\*\*Add VS prefix to order with Vibra Seal

\*5/32 and 3/16 with black button



### Male Run Tee Rigid 171PTCNS

PART NO.	TUBE 1 SIZE	TUBE 2 SIZE	PIPE THREAD	L1	L2	N	WRENCH FLATS
171PTCNS-5/32-2*	5/32	5/32	1/8	.76	.76	.75	7/16
171PTCNS-5/32-4*	5/32	5/32	1/4	.76	.76	.88	7/16
171PTCNS-3-2*	3/16	3/16	1/8	.77	.77	.75	7/16
171PTCNS-4-2	1/4	1/4	1/8	.91	.91	.77	15/32
171PTCNS-4-4	1/4	1/4	1/4	.88	.88	.91	15/32
171PTCNS-4-6-4	1/4	3/8	1/4	.88	1.10	.97	5/8
171PTCNS-6-4	3/8	3/8	1/4	1.10	1.10	.97	5/8
171PTCNS-6-4-4	3/8	1/4	1/4	1.10	.88	.97	5/8
171PTCNS-6-4-6	3/8	1/4	3/8	1.22	.97	.93	5/8
171PTCNS-6-6	3/8	3/8	3/8	1.10	1.10	.91	5/8
171PTCNS-6-8	3/8	3/8	1/2	1.09	1.17	1.26	5/8
171PTCNS-8-4	1/2	1/2	1/4	1.31	1.28	1.07	3/4

\*5/32 and 3/16 with black button

\*\*Add VS prefix to order with Vibra Seal

\*5/32 and 3/16 with black button



### Male Branch Tee Rigid 172PTCNS

PART NO.	TUBE 1 SIZE	TUBE 2 SIZE	PIPE THREAD	L1	L2	N	WRENCH FLATS
172PTCNS-5/32-2*	5/32	1/8	.78	.75	7/16	.47	15/32
172PTCNS-5/32-4*	5/32	1/4	.78	.88	7/16	.47	15/32
172PTCNS-3-2*	3/16	1/8	.77	.75	7/16	.47	15/32
172PTCNS-4-2	1/4	1/4	1/8	.91	.91	.77	1/2
172PTCNS-4-4	1/4	1/4	1/4				
172PTCNS-6-4	3/8	3/8	1/4	1.10	1.10	.97	5/8
172PTCNS-6-4-4	3/8	1/4	1/4	1.10	.85	.97	5/8
172PTCNS-6-6	3/8	3/8	3/8	1.04	1.04	.91	5/8
172PTCNS-6-8	3/8	3/8	1/2	1.17	1.17	1.26	7/8
172PTCNS-8-6	1/2	1/2	3/8	1.31	1.31	1.07	3/4
172PTCNS-8-6-8	1/2	3/8	1/2	1.31	1.24	1.25	3/4
172PTCNS-8-8	1/2	1/2	1/2	1.31	1.31	1.25	3/4

\*Add VS prefix to order with Vibra Seal

**WARNING** These products can expose you to chemicals including NICKEL or LEAD, which are known to the state of California to cause cancer, and LEAD which is known to cause birth defects or other reproductive harm. For more information go to [www.P65Warnings.ca.gov](http://www.P65Warnings.ca.gov).





Click here for CADs, Product Specifications or to Configure Parts Online

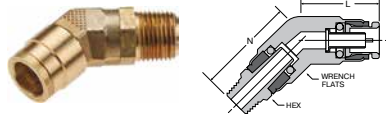

### Male Elbow Swivel 45° 179PTC

PART NO.	TUBE SIZE	PIPE THREAD	L	N	HEX	WRENCH FLATS
179PTC-4-2	1/4	1/8	.76	.93	9/16	9/16
179PTC-4-4	1/4	1/4	.76	1.15	9/16	9/16
179PTC-6-2	3/8	1/8	.95	1.05	11/16	3/4
179PTC-6-4	3/8	1/4	.95	1.17	11/16	3/4
179PTC-6-6	3/8	3/8	.95	1.20	11/16	3/4
179PTC-8-4	1/2	1/4	1.15	1.70	13/16	13/16
179PTC-8-6	1/2	3/8	1.15	1.78	13/16	13/16
179PTC-8-8	1/2	1/2	1.15	1.93	7/8	13/16
179PTC-10-8	5/8	1/2				

\*Add VS prefix to order with Vibra Seal

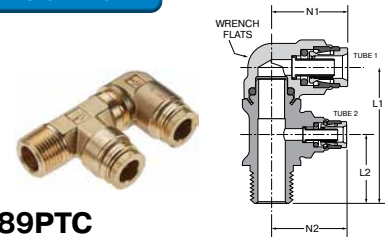

### Dual Port 90 Male Elbow Positional 189PTC

PART NO.	TUBE 1 SIZE	TUBE 2 SIZE	PIPE THREAD	L1	L2	N1	N2	WRENCH FLATS
189PTC-6-4-6	3/8	1/4	3/8	2.12	1.05	1.21	1.19	11/16
189PTC-6-6-4	3/8	3/8	1/4	2.06	.98	1.12	1.20	9/16
189PTC-6-6-6	3/8	3/8	3/8	2.06	.98	1.12	1.20	9/16
189PTC-10-4-6	5/8	1/4	3/8	2.27	.99	1.47	1.13	7/8
189PTC-10-6-6	5/8	3/8	3/8	2.35	1.06	1.47	1.13	7/8
189PTC-8-4-8	1/2	1/4	1/2					
189PTC-8-6-6	1/2	3/8	3/8					
189PTC-8-6-8	1/2	3/8	1/2					
189PTC-10-4-8	5/8	1/4	1/2					
189PTC-10-6-8	5/8	3/8	1/2					
189PTC-10-10-8	5/8	5/8	1/2					

\*Add VS prefix to order with Vibra Seal

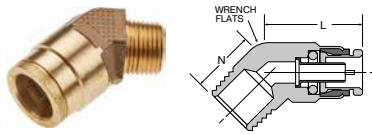

### Male Elbow Rigid 45° 179PTCNS

PART NO.	TUBE SIZE	PIPE THREAD	L	N	WRENCH FLATS
179PTCNS-4-2	1/4	1/8	.74	.56	9/16
179PTCNS-4-4	1/4	1/4	.74	.69	9/16
179PTCNS-6-2	3/8	1/8	1.06	.60	9/16
179PTCNS-6-4	3/8	1/4	1.06	.69	9/16
179PTCNS-6-6	3/8	3/8	1.06	.85	9/16
179PTCNS-6-8	3/8	1/2			
179PTCNS-8-4	1/2	1/4	1.15	.75	13/16
179PTCNS-8-6	1/2	3/8	1.15	.75	13/16
179PTCNS-8-8	1/2	1/2	1.15	1.00	13/16
179PTCNS-10-6	5/8	3/8	1.20	.76	7/8
179PTCNS-10-8	5/8	1/2	1.21	.95	7/8
179PTCNS-12-8	3/4	1/2	1.33	1.19	1

\*Add VS prefix to order with Vibra Seal

**WARNING** These products can expose you to chemicals including NICKEL or LEAD, which are known to the state of California to cause cancer, and LEAD which is known to cause birth defects or other reproductive harm. For more information go to [www.P65Warnings.ca.gov](http://www.P65Warnings.ca.gov).



[Click here for CADs, Product Specifications or to Configure Parts Online](#)

- A
- B
- C
- D
- E
- F
- G
- H
- I
- J
- K
- L
- M
- N
- O

### Retaining Ring Bulkhead Unions

Retaining ring bulkhead unions feature a unique design that provides the user with an economical method to install and assemble a union connection through a bulkhead.

The retaining ring bulkhead unions feature a smaller envelope size than standard bulkhead union connectors and do not require a wrench to mount or assemble in cramped areas.

The external seal feature provides a moisture barrier and can also prevent external contamination from entering into an enclosed area.

To install, simply support the bulkhead union from behind and apply the external seal. Then push the external retainer against the external seal with an assembly tool and you have a reliable bulkhead connection in a confined area.

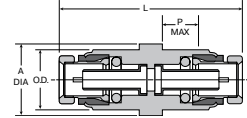
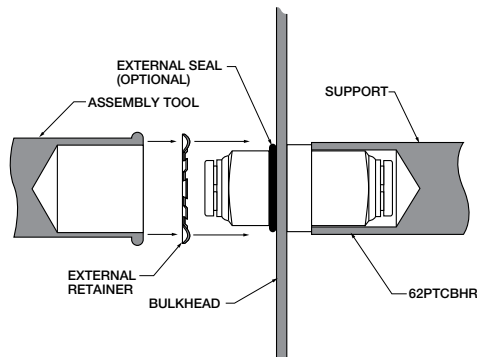

### Retaining Ring Bulkhead 62PTCBHR

PART NO.	TUBE SIZE	O. D.	REC. HOLE SIZE	L	P MAX	A DIA.
62PTCBHR-4*	1/4	.500	.512	1.53	.26	.625
62PTCBHR-6	3/8	.750	.762	1.92	.36	.875
62PTCBHR-8	1/2	.875	.887	2.15	.43	1.000
62PTCBHR-10	5/8	1.000	1.012	2.32	.48	1.250

\*Sleeve color may vary

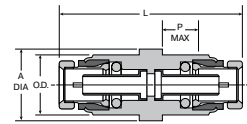

### Bulkhead Union 62PTCBH

PART NO.	TUBE SIZE	O. D.	L	P MAX	HEX A	HEX B	A DIA.
62PTCBH-4*	1/4	.56	1.69	.25	11/16	3/4	9/16
62PTCBH-6	3/8	.88	1.93	.44	1-1/16	1-1/16	7/8
62PTCBH-8	1/2	1.00	2.02	.58	1-1/4	1-1/4	1
62PTCBH-10	5/8	1.12	2.40	.81	1-1/4	1-3/8	1-1/8

\*Sleeve color may vary

### External Retainer ERHD\*

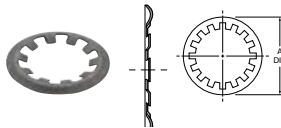

PART NO.	TUBE SIZE	BULKHEAD UNION O. D.	A DIA.	W
ERHD-50	1/4	.500	.83	.05
ERHD-75	3/8	.750	1.08	.05
ERHD-87	1/2	.875	1.20	.05
ERHD-100	5/8	1.000	1.33	.06

\*Material Carbon Spring Steel

### External Seal ES\*

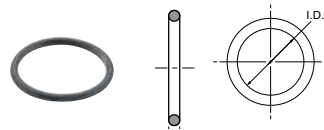

PART NO.	TUBE SIZE	BULKHEAD UNION O. D.	I. D.	W
2564-40001-L	1/4	.500	.489	.07
2564-60001	3/8	.750	.739	.07
2564-00253	1/2	.875	.864	.07

\*Material is Nitrile (Buna N), 70 Durometer

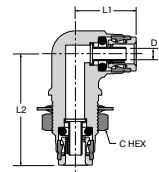

### Union Bulkhead Elbow 165PTCBH

PART NO.	TUBE SIZE	L1	L2	C HEX	FLOW DIA. D	BULKHEAD HOLE DIA.
165PTCBH-8	1/2	1.20	2.51	1 1/4	.34	1

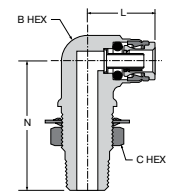

### Male Elbow Bulkhead 169PTCNSBH

PART NO.	TUBE SIZE	PIPE THREAD	L	N	B HEX	C HEX	BULKHEAD HOLE DIA.
169PTCNSBH-6-8	1/2	1/2	1.29	2.50	1-1/4	7/8	1

**WARNING** These products can expose you to chemicals including NICKEL or LEAD, which are known to the state of California to cause cancer, and LEAD which is known to cause birth defects or other reproductive harm. For more information go to [www.P65Warnings.ca.gov](http://www.P65Warnings.ca.gov).



Click here for CADs, Product Specifications or to Configure Parts Online

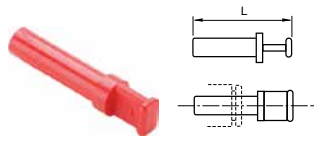

### 639PLP Plug

PART NO.	TUBE SIZE (IN)	L
639PLP-4	1/4	1.44
639PLP-6	3/8	1.67
639PLP-8	1/2	1.91



### AQRT - Quick Release Tool

Makes disconnection of tube adapters and tubing a breeze.



### PTCB Collet Caps

	TUBE O.D.			
	1/4	3/8	1/2	5/8
<b>WHITE PART NO.</b>	4-PTCB-W	6-PTCB-W	8-PTCB-W	10-PTCB-W
<b>BLACK PART NO.</b>	4-PTCB-BL	6-PTCB-BL	8-PTCB-BL	10-PTCB-BL
<b>GREEN PART NO.</b>	4-PTCB-G	6-PTCB-G	8-PTCB-G	10-PTCB-G
<b>RED PART NO.</b>	4-PTCB-R	6-PTCB-R	8-PTCB-R	10-PTCB-R
<b>BLUE PART NO.</b>	4-PTCB-BU	6-PTCB-BU	8-PTCB-BU	10-PTCB-BU
<b>YELLOW PART NO.</b>	4-PTCB-Y	6-PTCB-Y	8-PTCB-Y	10-PTCB-Y
<b>BROWN PART NO.</b>	4-PTCB-BR	6-PTCB-BR	8-PTCB-BR	10-PTCB-BR
<b>GREY PART NO.</b>	4-PTCB-GR	6-PTCB-GR	8-PTCB-GR	10-PTCB-GR
<b>ORANGE PART NO.</b>	4-PTCB-O	6-PTCB-O	8-PTCB-O	10-PTCB-O
<b>PURPLE PART NO.</b>	4-PTCB-PU	6-PTCB-PU	8-PTCB-PU	10-PTCB-PU
<b>DARK PURPLE PART NO.</b>	4-PTCB-DPU	6-PTCB-DPU	8-PTCB-DPU	10-PTCB-DPU

**WARNING** These products can expose you to chemicals including NICKEL or LEAD, which are known to the state of California to cause cancer, and LEAD which is known to cause birth defects or other reproductive harm. For more information go to [www.P65Warnings.ca.gov](http://www.P65Warnings.ca.gov).





# Metric Prestomatic Fittings

Parker's Metric Prestomatic Fittings are robust, all brass push-to-connect fittings that meet DIN and D.O.T. specifications. Designed for all D.O.T truck and trailer applications, Parker Metric Prestomatic fittings reduce assembly time versus compression style fittings by 90%.

### Product Features:

- Brass Collet
- Buna N O-ring
- Stainless Steel Tube Support
- Meets D.O.T. FMVSS571.106
- Meets DIN 74324

### Markets:

- Heavy Duty Truck
- Trailer
- Mobile

### Applications:

- Air Brakes
- Air Tanks
- Air Ride
- Sliders
- Tire Inflation
- Primary & Secondary Air Lines

### Specifications:

**Pressure Range** Up to 250 PSI (17.2 bar)

**Temperature Range** -40° to +200° F (-40° to +93.3° C)

### Compatible Tubing:

- DIN 73378 Virgin Nylon
- SAE J844 Type A & B nylon tubing

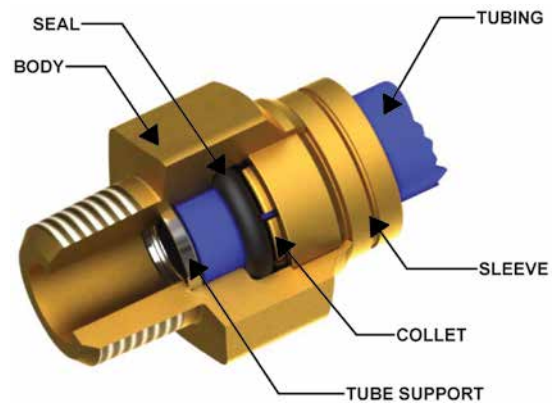

### Assembly Instructions

1. Cut tubing squarely – maximum of 15° angle allowable.
2. Check that port or mating part is clean and free of debris.
3. Mark tubing to appropriate tube insertion length. (see Tube Insertion Chart on page N22)
4. Insert tubing until it bottoms
5. Pull on tubing to verify it is fully inserted
6. To disassemble, simply press release button, hold against body and pull tubing out of fitting.

**WARNING** These products can expose you to chemicals including NICKEL or LEAD, which are known to the state of California to cause cancer, and LEAD which is known to cause birth defects or other reproductive harm. For more information go to [www.P65Warnings.ca.gov](http://www.P65Warnings.ca.gov).

[Click here for CADs, Product Specifications or to Configure Parts Online](#)

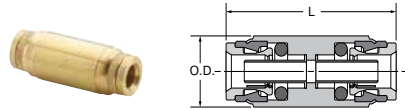

**Union HPMTB**

PART NO.	TUBE SIZE (MM)	L (MM)	O.D. (MM)
HPMTB6	6	45.2	15.9
HPMTB8	8	45.3	17.5
HPMTB10	10	51.7	22.2
HPMTB12	12	51.7	22.2

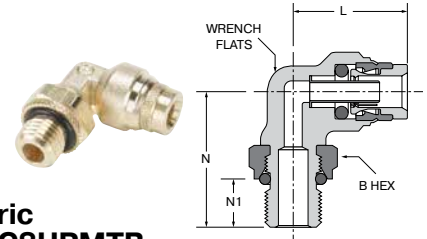

**Male Elbow Metric Straight Thread C8UPMTB**

PART NO.	TUBE SIZE (MM)	B METRIC THREAD	WRENCH FLATS (MM)	HEX (MM)	L (MM)	N (MM)	N1 (MM)
C8UPMTB6-M12	6	M12X1.5	10	17	24.8	28.2	9.5
C8UPMTB6-M16	6	M16X1.5	11	24	25.0	34.0	10.5

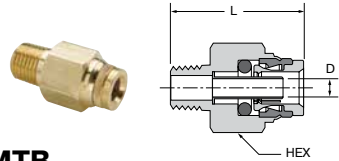

**Male Connector F2PMTB**

PART NO.	TUBE (MM)	PIPE THREAD	L (MM)	HEX (MM)	FLOW DIA. D (MM)
F2PMTB8-1/8	8	1/8	33.79	19	4.90
F2PMTB10-1/4	10	1/4	36.83	20	6.35

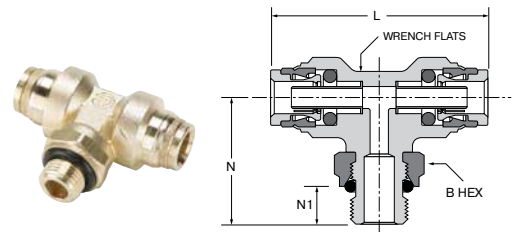

**Male Branch Tee Swivel Metric Straight Thread S8UPMTB**

PART NO.	TUBE SIZE (MM)	METRIC THREAD	WRENCH FLATS (MM)	HEX (MM)	L (MM)	N (MM)	N1 (MM)
S8UPMTB12-M16	12	M16X1.5	19	24	65.9	37.6	10.5

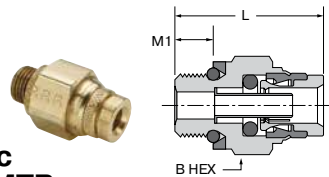

**Male Connector Metric Straight Thread F8UPMTB**

PART NO.	TUBE SIZE (mm)	METRIC THREAD	L (mm)	B HEX (MM)	M1 (MM)
F8UPMTB6-M10	6	M10X1	29.7	17	6.4
F8UPMTB6-M12	6	M12X1.5	29.1	17	7.5
F8UPMTB6-M22	6	M22X1.5	29.7	27	9.5
F8UPMTB8-M16	8	M16X1.5	31.0	22	10.0
F8UPMTB10-M16	10	M16X1.5	37.5	22	10.0
F8UPMTB10-M22	10	M22X1.5	31.1	27	9.5
F8UPMTB12-M12	12	M12X1.5	37.3	22	7.5
F8UPMTB12-M22	12	M22X1.5	33.4	27	9.5
F8UPMTB16-M22	16	M22X1.5	33.3	27	9.5

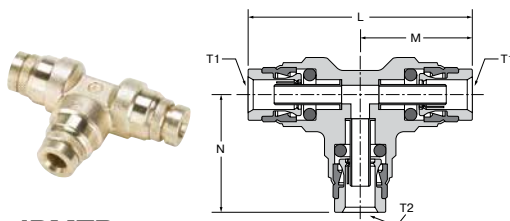

**Union Tee JPMTB**

PART NO.	TUBE 1 (MM)	TUBE 2 (MM)	L (MM)	M (MM)	N (MM)
JPMTB6	6	6	51.3	25.6	26.7
JPMTB12	12	12	63.3	31.7	35.0
JPMTB12-12-6	12	6	63.3	31.7	28.1

**WARNING** These products can expose you to chemicals including NICKEL or LEAD, which are known to the state of California to cause cancer, and LEAD which is known to cause birth defects or other reproductive harm. For more information go to [www.P65Warnings.ca.gov](http://www.P65Warnings.ca.gov).



- A
- B
- C
- D
- E
- F
- G
- H
- I
- J
- K
- L
- M
- N
- O

A  
B  
C  
D  
E  
F  
G  
H  
I  
J  
K  
L  
M  
N  
O



# Parker Safe Lock

Parker Safe Lock push-to-connect fittings reduce assembly time and the exclusive locking mechanism minimizes leaks and installation failures.

## Parker Safe Lock Product Features:

- Composite Body – Strong, Lightweight, Compact and Impact Resistant
- Fluorocarbon and Fluorosilicone O-ring
- Meets SAE J2044

## Markets:

- Heavy Duty Truck
- Trailer
- Mobile

## Applications:

- Engine Fuel, Coolant and Vapor Lines

## Specifications:

**Pressure Range** -7.2 to +72 PSI (-0.4 to 4.9 bar)

**Temperature Range** -40° to +239° F (-40° to +115° C)

## Parker Brass Adapter Product Features:

- **Construction:** Corrosion resistant high temperature brass
- **Configuration:** Rigid male pipe
- **Industry Standard:** SAE J2044

**WARNING** These products can expose you to chemicals including NICKEL or LEAD, which are known to the state of California to cause cancer, and LEAD which is known to cause birth defects or other reproductive harm. For more information go to [www.P65Warnings.ca.gov](http://www.P65Warnings.ca.gov).

[Click here for CADs, Product Specifications or to Configure Parts Online](#)

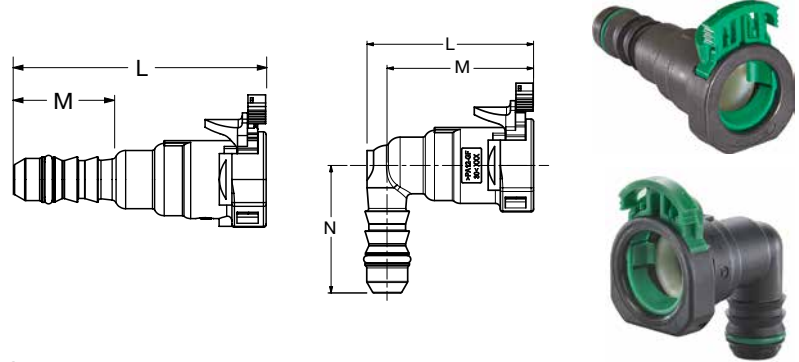

**Parker Safe Lock A613, A614, A623, A624**

END FORM	BARB TAIL	CONFIGURATION	PART NUMBER** AVAILABLE FROM FSC*	L (MM)	M (MM)	N (MM)
5/16"	5/16"	STRAIGHT	A614A50G06 02	49.40	19.50	N/A
		90 DEGREE	A624A50D06 02	29.50	19.50	25.70
10MM	3/8"	STRAIGHT	A613 52 08 00	55.00	19.00	N/A
		90 DEGREE	A623A52 08 00	34.40	19.00	32.00
3/8"	3/8"	STRAIGHT	A614M53 08 02	55.00	21.50	N/A
		90 DEGREE	A624M53 08 02	34.05	21.50	28.60
12MM	1/2"	STRAIGHT	A614A58 55 04	59.35	21.00	N/A
		90 DEGREE	A624A58 55 04	39.00	21.00	29.70
1/2"	1/2"	STRAIGHT	A614C56 55 05	59.15	21.00	N/A
		90 DEGREE	A624C56 55 05	39.00	21.00	29.70
5/8"	5/8"	STRAIGHT	A614D57 56 02 A	58.20	20.00	N/A
		90 DEGREE	624F57 56 02	39.10	20.00	30.10

\*FSC is the Parker Fluid System Connectors Division. See back cover for contact information.

\*\*Safe Lock Connector part numbers contain spaces.



**Parker Safe Lock Brass Adapter 68ALS**

PART NUMBER AVAILABLE FROM FSC*	END FORM	THREAD SIZE	PART NUMBER AVAILABLE FROM FSC*	END FORM	THREAD SIZE
68ALS-5-4	5/16"	1/4"	68ALS-12M-8	12MM	1/2"
68ALS-6-4	3/8"	1/4"	68ALS-8-6	1/2"	3/8"
68ALS-6-6	3/8"	3/8"	68ALS-8-8	1/2"	1/2"
68ALS-12M-6	12MM	3/8"	68ALS-10-8	5/8"	1/2"

Adapters are available with Metric Straight Thread O-Rings and Electroless Nickel Plating Upon Request

**WARNING** These products can expose you to chemicals including NICKEL or LEAD, which are known to the state of California to cause cancer, and LEAD which is known to cause birth defects or other reproductive harm. For more information go to [www.P65Warnings.ca.gov](http://www.P65Warnings.ca.gov).





# Transportation Compression Fittings & Valves

Air Brake-NTA® Fittings

Transmission Fittings

Air Brake - AB Fittings

Air Brake Hose Ends Fittings

Vibra-Lok Fittings

Truck Valves & Lanyard Valve





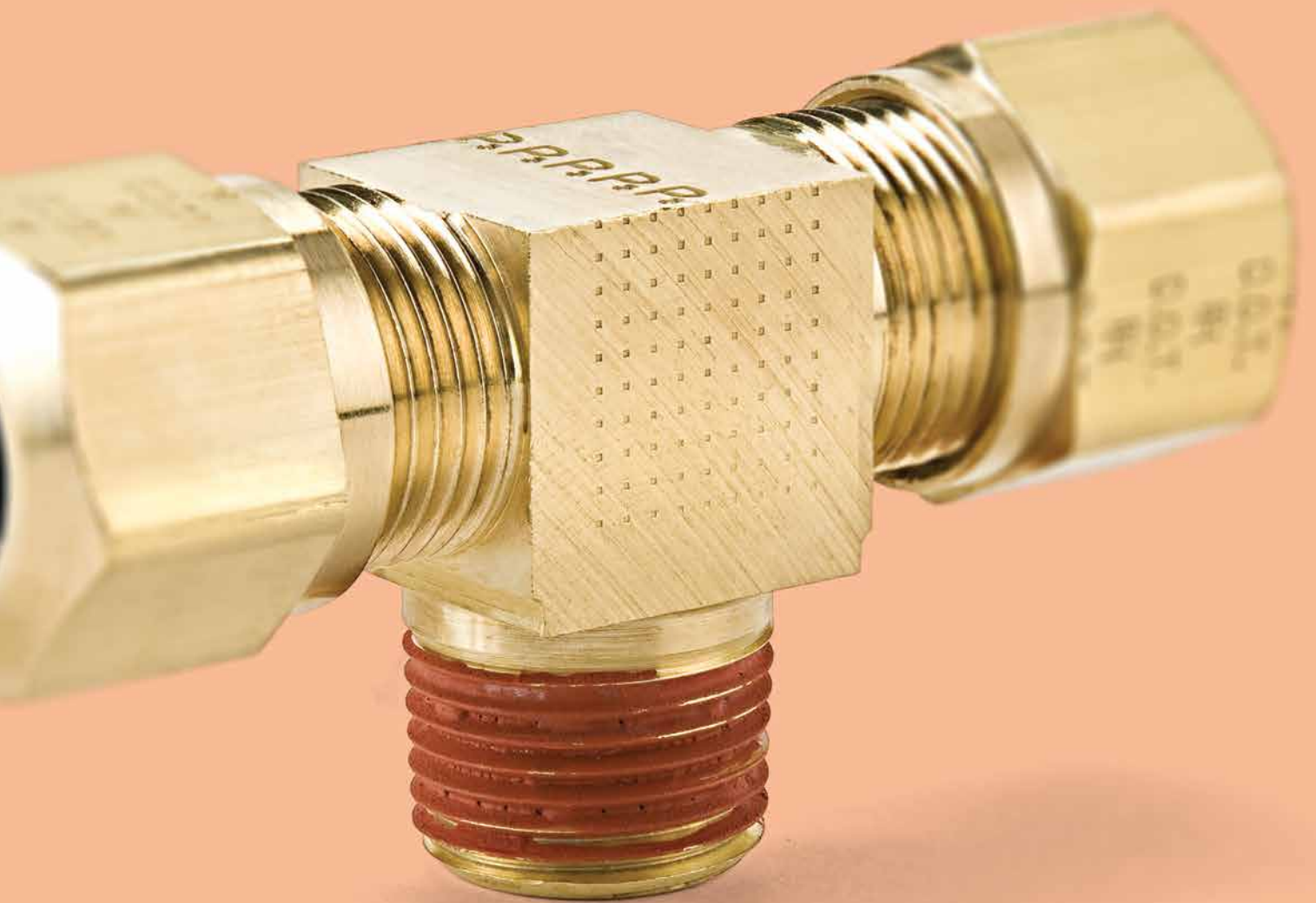

**■ Air Brake–NTA® Fittings**

**60NTA**  
Sleeve  
p. F7



**61NTA**  
Nut  
p. F7



**62NTA**  
Union  
p. F7



**62ANBH**  
Bulkhead Union  
p. F7



**62NBH**  
Bulkhead Union  
p. F7



**62NFBH**  
Bulkhead Union  
p. F7



**63NTA**  
Tube Support  
p. F8



**66NBH**  
Bulkhead Union  
p. F8



**66NTA**  
Female Connector  
NPTF  
p. F8



**VS68NTA**  
Male Connector  
NPTF  
p. F8



**68NTA-X-MIX**  
Male Connector  
p. F8



**VS176NTA**  
Adapter  
NPTF  
p. F8



**264NTA**  
Union Tee  
p. F9



**265NTA**  
Union Elbow  
p. F9



**VS269NTA**  
Male Elbow  
NPTF  
p. F9



**270NTA**  
Female Elbow  
NPTF  
p. F9



**VS271NTA**  
Male Run Tee  
NPTF  
p. F9



**VS272NTA**  
Male Branch Tee  
NPTF  
p. F10



**VS279NTA**  
45° Male Elbow  
NPTF  
p. F10



**■ Transmission Fittings**

**60TF**  
Sleeve  
p. F12



**61TF**  
Nut  
p. F12



**62TF**  
Union  
p. F12



**68TF**  
Male Connector  
NPTF  
p. F12



**269TF**  
Male Elbow  
NPTF  
p. F12



**■ Air Brake – AB Fittings**

**60AB**  
Sleeve  
p. F14



**61AB**  
Nut  
p. F14



**62AB**  
Union  
p. F14



**62ABH**  
Bulkhead Union  
p. F14



**66AB**  
Female Connector  
NPTF  
p. F14



**VS68AB**  
Male Connector  
NPTF  
p. F14



**264AB**  
Union Tee  
p. F15



**265AB**  
Union Elbow  
p. F15



**VS269AB**  
Male Elbow  
NPTF  
p. F15



**270AB**  
Female Elbow  
NPTF  
p. F15



**VS271AB**  
Male Run Tee  
NPTF  
p. F15



**VS272AB**  
Male Branch Tee  
NPTF  
p. F16



**VS279AB**  
45° Male Elbow  
NPTF  
p. F16



**207ACBH**  
Anchor Coupling  
NPTF  
p. F16



**⚠** WARNING These products can expose you to chemicals including NICKEL, CARBON BLACK, or LEAD, which are known to the state of California to cause cancer, and LEAD which is known to cause birth defects or other reproductive harm. For more information go to [www.P65Warnings.ca.gov](http://www.P65Warnings.ca.gov).

**■ Air Brake Hose Ends Fittings**

**56RBSG**  
Spring  
p. F18



**60RB**  
Sleeve  
p. F18



**61RB**  
Nut  
p. F18



**61RBSG**  
Spring Guard Nut  
p. F18



**62RB**  
Union  
p. F18



**66RBSV**  
Female Connector  
NPTF  
p. F18



**67RBSG**  
Nut & Spring  
p. F18



**68RB**  
Male Connector  
NPTF  
p. F18



**68RB**  
Male Connector  
Body Only – NPTF  
p. F18



**68RBSG**  
Male Connector  
NPTF  
p. F18



**76RB**  
Adapter  
NPTF  
p. F18



**■ Vibra-Lok Fittings**

**60VL**  
Sleeve  
p. F20



**60VLV**  
Sleeve  
p. F20



**61VL**  
Nut  
p. F20



**62VL**  
Union  
p. F20



**66VL**  
Female Connector  
NPTF  
p. F21



**68VL**  
Male Connector  
NPTF  
p. F21



**685VLV**  
Male Connector  
p. F21



**164VL**  
Union Tee  
p. F21



**169VL**  
Male Elbow  
NPTF  
p. F21



**682VL**  
Tank Fitting  
NPTF  
p. F21



**1695VL**  
Male Elbow  
p. F22



**170VL**  
Female Elbow  
NPTF  
p. F22



**171VL**  
Male Run Tee  
NPTF  
p. F22



**172VL**  
Male Branch Tee  
NPTF  
p. F22



**179VL**  
45° Male Elbow  
NPTF  
p. F22



**■ Truck Valves & Lanyard Valve**

**V404P**  
Hose – Pipe  
p. F24



**V404PH**  
Hose – Pipe  
p. F24



**SV404P**  
Hose – Pipe  
p. F24



**V405P**  
Female – Male  
p. F24



**V408NTA**  
Tube – Pipe  
p. F24



**V409F**  
Flare – Pipe  
p. F24



**V410NTA**  
Tube – Pipe  
p. F24



**V412F**  
Tube – Flare  
p. F24



**LV91**  
Lanyard Valve  
p. F24



**⚠** WARNING These products can expose you to chemicals including NICKEL, CARBON BLACK, or LEAD, which are known to the state of California to cause cancer, and LEAD which is known to cause birth defects or other reproductive harm. For more information go to [www.P65Warnings.ca.gov](http://www.P65Warnings.ca.gov).



A  
B  
C  
D  
E  
F  
G  
H  
I  
J  
K  
L  
M  
N  
O

A  
B  
C  
D  
E  
F  
G  
H  
I  
J  
K  
L  
M  
N  
O



# Air Brake-NTA<sup>®</sup> Fittings

Parker's NTA Fittings utilize a ribbed sleeve for compression and positive grip. Fittings meet SAE and D.O.T. specifications. Designed for all D.O.T truck and trailer applications. Electroless nickel plated bodies can be used with bio-diesel.

## Product Features:

- Brass Body
- Meets D.O.T. FMVSS571.106 Performance
- Meets functional Requirements SAE J246 & SAE J1131
- Pre-applied Thread Sealant
- Nickel Plated Versions Available for Bio-diesel

## Markets:

- Heavy Duty Truck
- Trailer
- Mobile

## Applications:

- Air Brakes
- Air Tanks
- Air Ride
- Sliders
- Tire Inflation
- Primary & Secondary Air Lines
- Cab Controls

## Specifications:

**Pressure Range** Up to 150 PSI (10.3 bar)

**Temperature Range** -40° to +200° F (-40° to +93.3° C)

## Compatible Tubing:

- SAE J844 Type A & B nylon tubing

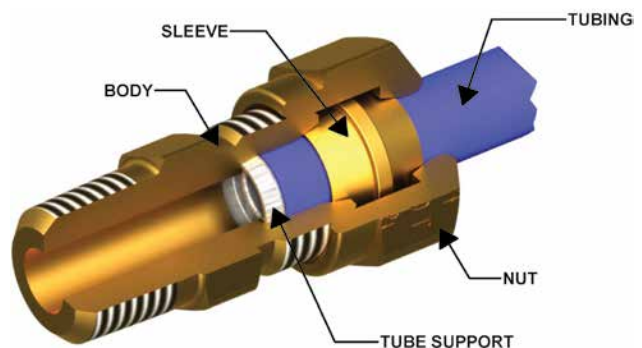

## Assembly Instructions

1. Cut tubing squarely – maximum of 15° angle allowable.
2. Check that port or mating part is clean and free of debris.
3. Insert tubing until it bottoms on seat.
4. Tighten nut with wrench until one thread remains visible on the fitting body; (this will allow for a number of remakes) or, the nut should be screwed down finger tight, then wrench-tightened as indicated in the following table.

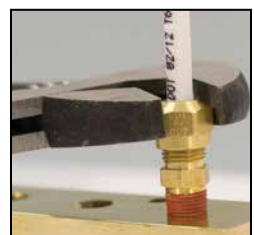

TUBE SIZE	ADDITIONAL NUMBER OF TURNS FROM HAND-TIGHT
3/16	2-1/2
1/4	3
3/8 & 1/2	4
5/8 & 3/4	3-1/2

**WARNING** These products can expose you to chemicals including NICKEL or LEAD, which are known to the state of California to cause cancer, and LEAD which is known to cause birth defects or other reproductive harm. For more information go to [www.P65Warnings.ca.gov](http://www.P65Warnings.ca.gov).



[Click here for CADs, Product Specifications or to Configure Parts Online](#)

### Sleeve 60NTA

REF. SAE 100115



PART NO.	TUBE SIZE	A	D	L
60NTA-3*	3/16	.255	.194	.23
60NTA-4	1/4	.359	.256	.30
60NTA-6	3/8	.479	.384	.39
60NTA-8	1/2	.624	.509	.43
60NTA-10	5/8	.746	.634	.49
60NTA-12	3/4	.922	.760	.54

\*Meets D.O.T. FMVSS 571.106 specification. No applicable SAE specification for this tube size.

### Bulkhead Union 62ANBH

(NTA® & AIR BRAKE)

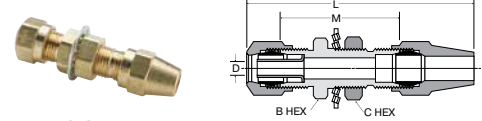

PART NO.	TUBE SIZE	STRAIGHT THREAD	B HEX	C HEX	L	M	FLOW DIA. D	BULKHEAD HOLE DIA.
62ANBH-4	1/4	7/16-24	9/16	9/16	2.28	1.38	.137	7/16
62ANBH-6	3/8	17/32-24	11/16	3/4	2.97	1.62	.217	17/32
62ANBH-8	1/2	11/16-20	13/16	1	3.36	1.88	.338	11/16

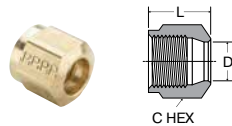

### Nut 61NTA

REF. SAE 100110

PART NO.	TUBE SIZE	STRAIGHT THREAD	C HEX	D	L
61NTA-3*	3/16	5/16-24	7/16	.194	.40
61NTA-4	1/4	7/16-24	9/16	.256	.45
61NTA-6	3/8	17/32-24	5/8	.384	.63
61NTA-8	1/2	11/16-20	13/16	.509	.72
61NTA-10	5/8	13/16-18	15/16	.634	.77
61NTA-12	3/4	1-18	1-1/8	.760	.81

\*Meets D.O.T. FMVSS 571.106 specification. No applicable SAE specification for this tube size.

### Bulkhead Union 62NBH

PART NO.	TUBE SIZE	STRAIGHT THREAD	B HEX	C HEX	L	M	FLOW DIA. D	BULKHEAD HOLE DIA.
62NBH-3*	3/16	5/16-24	7/16	7/16	1.80	1.21	.087	5/16
62NBH-4	1/4	7/16-24	9/16	9/16	2.04	1.38	.137	7/16
62NBH-6	3/8	17/32-24	11/16	3/4	2.54	1.62	.217	17/32
62NBH-8	1/2	11/16-20	13/16	1	2.92	1.88	.338	11/16
62NBH-10	5/8	13/16-18	15/16	1	2.99	2.01	.398	13/16

\*Meets D.O.T. FMVSS 571.106 specification. No applicable SAE specification for this tube size.

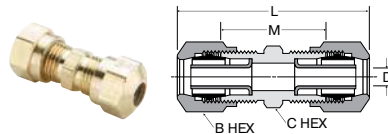

### Union 62NTA

REF. SAE 100101 BA

PART NO.	TUBE SIZE	STRAIGHT THREAD	B HEX	C HEX	L	M	FLOW DIA. D
62NTA-4	1/4	7/16-24	9/16	7/16	1.49	.83	.137
62NTA-6	3/8	17/32-24	5/8	9/16	2.00	1.08	.217
62NTA-8	1/2	11/16-20	13/16	11/16	2.32	1.29	.338
62NTA-10	5/8	13/16-18	15/16	13/16	2.39	1.41	.398
62NTA-12	3/4	1-18	1-1/8	1	2.60	1.58	.523

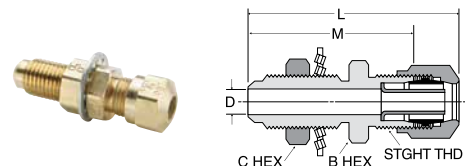

### Bulkhead Union 62NFBH

PART NO.	TUBE SIZE	FLARE SIZE	STGHT THD	B HEX	C HEX	L	M	FLOW DIA. D	BKHD HOLE DIA.
62NFBH-4	1/4	1/4	7/16-24	9/16	9/16	1.86	1.53	.137	7/16
62NFBH-6	3/8	3/8	17/32-24	3/4	3/4	2.24	1.78	.217	5/8
62NFBH-8	1/2	1/2	11/16-20	7/8	7/8	2.73	2.22	.338	3/4
62NFBH-10	5/8	5/8	13/16-18	1	1	2.68	2.21	.398	7/8
62NFBH-10-8	5/8	1/2	13/16-18	7/8	7/8	2.90	2.40	.398	3/4

**WARNING** These products can expose you to chemicals including NICKEL or LEAD, which are known to the state of California to cause cancer, and LEAD which is known to cause birth defects or other reproductive harm. For more information go to [www.P65Warnings.ca.gov](http://www.P65Warnings.ca.gov).



- A
- B
- C
- D
- E
- F
- G
- H
- I
- J
- K
- L
- M
- N
- O

Click here for CADs, Product Specifications or to Configure Parts Online

- A
- B
- C
- D
- E
- F
- G
- H
- I
- J
- K
- L
- M
- N
- O



### Stainless Steel Insert 63NTA

(FOR SAE J844 TUBING)

PART NO.	TUBE SIZE	L	O.D.
63NTA-4	1/4	.53	.163
63NTA-6	3/8	.64	.245
63NTA-8	1/2	.81	.370
63NTA-10	5/8	.86	.434
63NTA-12	3/4	1.04	.559

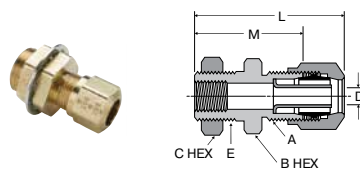

### Male Connector VS68NTA

Ref. SAE 100102 BA

PART NO.	TUBE SIZE	PIPE THREAD	STRAIGHT THREAD	C HEX	L	M	FLOW DIA. D
VS68NTA-3-1*	3/16	1/16	5/16-24	3/8	1.16	.87	.087
VS68NTA-3-2*	3/16	1/8	5/16-24	7/16	1.15	.86	.087
VS68NTA-3-4*	3/16	1/4	5/16-24	9/16	1.35	1.05	.087
VS68NTA-4-2	1/4	1/8	7/16-24	7/16	1.22	.89	.137
VS68NTA-4-4	1/4	1/4	7/16-24	9/16	1.43	1.10	.137
VS68NTA-4-6	1/4	3/8	7/16-24	11/16	1.47	1.14	.137
VS68NTA-6-2	3/8	1/8	17/32-24	9/16	1.49	1.03	.217
VS68NTA-6-4	3/8	1/4	17/32-24	9/16	1.67	1.21	.217
VS68NTA-6-6	3/8	3/8	17/32-24	11/16	1.70	1.24	.217
VS68NTA-6-8	3/8	1/2	17/32-24	7/8	1.89	1.43	.217
VS68NTA-8-4	1/2	1/4	11/16-20	11/16	1.85	1.33	.338
VS68NTA-8-6	1/2	3/8	11/16-20	11/16	1.85	1.33	.338
VS68NTA-8-8	1/2	1/2	11/16-20	7/8	2.04	1.52	.338
VS68NTA-10-6	5/8	3/8	13/16-18	13/16	1.88	1.39	.398
VS68NTA-10-8	5/8	1/2	13/16-18	7/8	2.10	1.58	.398
VS68NTA-12-6	3/4	3/8	1-18	1	2.00	1.49	.440
VS68NTA-12-8	3/4	1/2	1-18	1	2.19	1.68	.523
VS68NTA-12-12	3/4	3/4	1-18	1-1/8	2.22	1.71	.523

### Bulkhead Union 66NBH

PART NO.	TB SZ	PIPE THD	A STGHT THD	E STGHT THD	B HEX	C HEX	L	M	FLOW DIA. D	BKHD HOLE DIA.
66NBH-8-6	1/2	3/8	11/16-20	7/8-14	1-1/16	1-1/16	1.94	1.42	.338	7/8

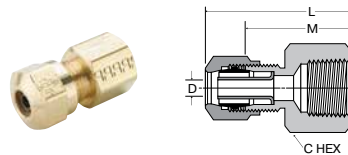

\*Meets D.O.T. FMVSS 571.106 specification. No applicable SAE specification for this tube size.

### Female Connector 66NTA

REF. SAE 100103 BA

PART NO.	TUBE SIZE	PIPE THREAD	STRAIGHT THREAD	C HEX	L	M	FLOW DIA. D
66NTA-4-2	1/4	1/8	7/16-24	9/16	1.17	.84	.137
66NTA-4-4	1/4	1/4	7/16-24	11/16	1.40	1.07	.137
66NTA-6-2	3/8	1/8	17/32-24	9/16	1.46	1.00	.217
66NTA-6-4	3/8	1/4	17/32-24	11/16	1.64	1.18	.217
66NTA-6-6	3/8	3/8	17/32-24	7/8	1.64	1.18	.217
66NTA-8-6	1/2	3/8	11/16-20	7/8	1.79	1.27	.338
66NTA-8-8	1/2	1/2	11/16-20	1-1/16	1.96	1.44	.338
66NTA-10-6	5/8	3/8	13/16-18	7/8	1.80	1.31	.398
66NTA-10-8	5/8	1/2	13/16-18	1-1/16	1.99	1.50	.398

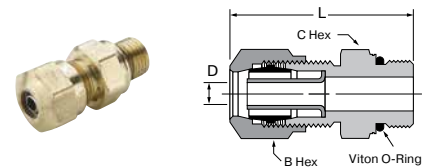

### NTA® to Metric Adaptor 68NTA-X-MIX

PART NO.	TUBE SIZE	METRIC THREAD	B HEX	C HEX	L	D
68NTA-4-M10	1/4	M10 X 1.0	9/16	9/16	1.33	.140

Note: Fluorocarbon o-ring is standard

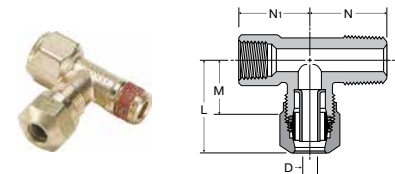

### Adapter Tee VS176NTA

PART NO.	TUBE SIZE	PIPE THREAD	STRAIGHT THREAD	L	M	N	N1	FLOW DIA. D
VS176NTA-4-2	1/4	1/8	7/16-24	1.02	.69	.75	.66	.137

**WARNING** These products can expose you to chemicals including NICKEL or LEAD, which are known to the state of California to cause cancer, and LEAD which is known to cause birth defects or other reproductive harm. For more information go to [www.P65Warnings.ca.gov](http://www.P65Warnings.ca.gov).

Click here for CADs, Product Specifications or to Configure Parts Online

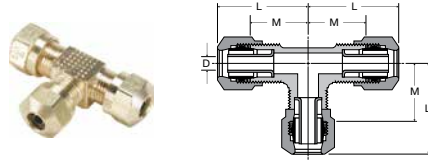

### Union Tee 264NTA

REF. SAE 100401 BA

PART NO.	TUBE SIZE	STRAIGHT THREAD	L	M	FLOW DIA. D
264NTA-4	1/4	7/16-24	.95	.62	.137
264NTA-6	3/8	17/32-24	1.24	.78	.217
264NTA-8	1/2	11/16-20	1.45	.93	.338
264NTA-10	5/8	13/16-18	1.58	1.09	.398

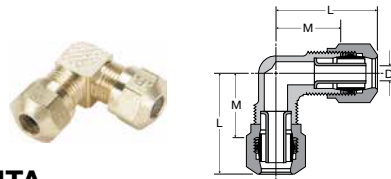

### Union Elbow 265NTA

REF. SAE 100201 BA

PART NO.	TUBE SIZE	STRAIGHT THREAD	L	M	FLOW DIA. D
265NTA-4	1/4	7/16-24	.95	.62	.137
265NTA-6	3/8	17/32-24	1.25	.79	.217
265NTA-8	1/2	11/16-20	1.45	.93	.338
265NTA-10	5/8	13/16-18	1.58	1.09	.398

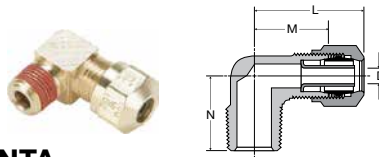

### Male Elbow VS269NTA

REF. SAE 100202 BA

PART NO.	TUBE SIZE	PIPE THREAD	STRAIGHT THREAD	L	M	N	FLOW DIA. D
VS269NTA-3-2*	3/16	1/8	5/16-24	.90	.60	.67	.087
VS269NTA-3-4*	3/16	1/4	5/16-24	.91	.62	.87	.087
VS269NTA-4-2	1/4	1/8	7/16-24	.95	.62	.66	.137
VS269NTA-4-4	1/4	1/4	7/16-24	1.00	.68	.87	.137
VS269NTA-4-6	1/4	3/8	7/16-24	1.16	.73	.86	.137
VS269NTA-6-2	3/8	1/8	17/32-24	1.19	.73	.75	.217
VS269NTA-6-4	3/8	1/4	17/32-24	1.25	.79	.92	.217
VS269NTA-6-6	3/8	3/8	17/32-24	1.30	.84	.91	.217
VS269NTA-6-8	3/8	1/2	17/32-24	1.40	.94	1.10	.217
VS269NTA-8-4	1/2	1/4	11/16-20	1.38	.86	.99	.338
VS269NTA-8-6	1/2	3/8	11/16-20	1.44	.92	.99	.338
VS269NTA-8-8	1/2	1/2	11/16-20	1.55	1.03	1.18	.338
VS269NTA-10-6	5/8	3/8	13/16-18	1.49	1.00	1.05	.398
VS269NTA-10-8	5/8	1/2	13/16-18	1.58	1.09	1.24	.398
VS269NTA-10-12	5/8	3/4	13/16-18	1.76	1.25	1.32	.400
VS269NTA-12-8	3/4	1/2	1-18	1.70	1.19	1.33	.523
VS269NTA-12-12	3/4	3/4	1-18	1.77	1.26	1.32	.523

\*Meets D.O.T. FMVSS 571.106 specification. No applicable SAE specification for this tube size.

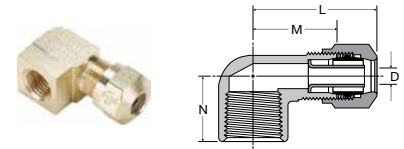

### Female Elbow 270NTA

REF. SAE 100203 BA

PART NO.	TUBE SIZE	PIPE THREAD	STRAIGHT THREAD	L	M	N	FLOW DIA. D
270NTA-3-2*	3/16	1/8	5/16-24	.96	.67	.52	.087
270NTA-4-2	1/4	1/8	7/16-24	1.02	.69	.52	.137
270NTA-4-4	1/4	1/4	7/16-24	1.11	.78	.71	.137
270NTA-6-2	3/8	1/8	17/32-24	1.29	.83	.59	.217
270NTA-6-4	3/8	1/4	17/32-24	1.35	.89	.77	.217
270NTA-6-6	3/8	3/8	17/32-24	1.39	.93	.77	.217
270NTA-8-6	1/2	3/8	11/16-20	1.55	1.03	.82	.338
270NTA-8-8	1/2	1/2	11/16-20	1.65	1.13	1.01	.338
270NTA-10-8	5/8	1/2	13/16-18	1.70	1.19	1.07	.398

\*Meets D.O.T. FMVSS 571.106 specification. No applicable SAE specification for this tube size.

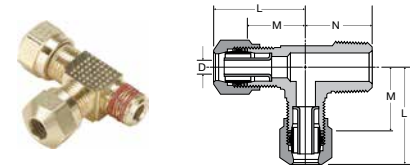

### Male Run Tee VS271NTA

REF. SAE 100424 BA

PART NO.	TUBE SIZE	PIPE THREAD	STRAIGHT THREAD	L	M	N	FLOW DIA. D
VS271NTA-4-2	1/4	1/8	7/16-24	.95	.62	.66	.137
VS271NTA-4-4	1/4	1/4	7/16-24	1.00	.68	.87	.137
VS271NTA-6-4	3/8	1/4	17/32-24	1.25	.79	.92	.217
VS271NTA-6-6	3/8	3/8	17/32-24	1.30	.84	.91	.217
VS271NTA-8-6	1/2	3/8	11/16-20	1.45	.93	.99	.338
VS271NTA-8-8	1/2	1/2	11/16-20	1.55	1.03	1.18	.338
VS271NTA-10-8	5/8	1/2	13/16-18	1.60	1.09	1.24	.398

**WARNING** These products can expose you to chemicals including NICKEL or LEAD, which are known to the state of California to cause cancer, and LEAD which is known to cause birth defects or other reproductive harm. For more information go to [www.P65Warnings.ca.gov](http://www.P65Warnings.ca.gov).



Click here for CADs, Product Specifications or to Configure Parts Online

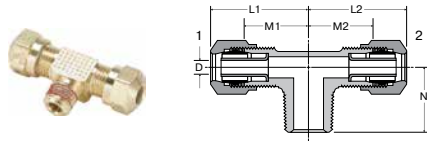

### Male Branch Tee VS272NTA

REF. SAE 100425 BA

PART NO.	TB 1	TB 2	PIPE THD	STGHT THD	L1	L2	M1	M2	N	FLOW DIA. D
VS272NTA-3-2*	3/16	3/16	1/8	5/16-24	.90	.90	.61	.61	.66	.087
VS272NTA-4-2	1/4	1/4	1/8	7/16-24	.95	.95	.62	.62	.66	.137
VS272NTA-4-4	1/4	1/4	1/4	7/16-24	1.00	1.00	.68	.68	.87	.137
VS272NTA-6-2	3/8	3/8	1/8	17/32-24	1.18	1.18	.75	.75	.73	.217
VS272NTA-6-4	3/8	3/8	1/4	17/32-24	1.25	1.25	.91	.91	.92	.217
VS272NTA-6-4-4	3/8	1/4	1/4	7/16-24	.99	1.25	.67	.79	.91	.137
				17/32-24						
VS272NTA-6-6	3/8	3/8	3/8	17/32-24	1.27	1.27	.84	.84	.91	.217
VS272NTA-8-4	1/2	1/2	1/4	11/16-20	1.45	1.45	.93	.93	.99	.338
VS272NTA-8-6	1/2	1/2	3/8	11/16-20	1.45	1.45	.93	.93	.99	.338
VS272NTA-8-8	1/2	1/2	1/2	11/16-20	1.55	1.55	1.03	1.03	1.18	.338
VS272NTA-10-8	5/8	5/8	1/2	13/16-18	1.60	1.60	1.09	1.09	1.24	.398

\*Meets D.O.T. FMVSS 571.106 specification. No applicable SAE specification for this tube size.

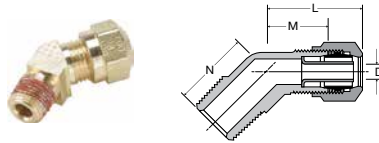

### 45° Elbow VS279NTA

REF. SAE 100302 BA

PART NO.	TUBE SIZE	PIPE THREAD	STRAIGHT THREAD	L	M	N	FLOW DIA. D
VS279NTA-4-2	1/4	1/8	7/16-24	.81	.49	.63	.137
VS279NTA-4-4	1/4	1/4	7/16-24	.93	.60	.85	.137
VS279NTA-6-2	3/8	1/8	17/32-24	1.17	.71	.68	.217
VS279NTA-6-4	3/8	1/4	17/32-24	1.17	.71	.85	.217
VS279NTA-6-6	3/8	3/8	17/32-24	1.21	.75	.94	.217
VS279NTA-6-8	3/8	1/2	17/32-24	1.24	.78	1.16	.217
VS279NTA-8-4	1/2	1/4	11/16-20	1.36	.84	.94	.338
VS279NTA-8-6	1/2	3/8	11/16-20	1.36	.84	.94	.338
VS279NTA-8-8	1/2	1/2	11/16-20	1.39	.87	1.16	.338
VS279NTA-10-6	5/8	3/8	13/16-18	1.43	.94	.98	.398
VS279NTA-10-8	5/8	1/2	13/16-18	1.42	.93	1.16	.398
VS279NTA-12-8	3/4	1/2	1-18	1.61	1.10	1.18	.523

**WARNING** These products can expose you to chemicals including NICKEL or LEAD, which are known to the state of California to cause cancer, and LEAD which is known to cause birth defects or other reproductive harm. For more information go to [www.P65Warnings.ca.gov](http://www.P65Warnings.ca.gov).







# Transmission Fittings

Parker's Transmission Fittings utilizes a specially designed slotted sleeve to help eliminate notch stress related to over-torque. Ideal for pressure protected pneumatic transmission applications. Electroless nickel plated bodies can be used with bio-diesel.

## Product Features:

- Brass Body
- D.O.T. Approved with Staked in Tube Support
- 3/16" & 5/32" Tube sizes
- Slotted Sleeve
- Nickel Plated Versions Available for Bio-diesel

## Markets:

- Heavy Duty Truck

## Applications:

- Air Shift Transmissions
- Seat Controls
- Dash Controls

## Specifications:

**Pressure Range** Up to 150 PSI (10.3 bar)

**Temperature Range** -40° to +200° F (-40° to +93.3° C)

## Compatible Tubing:

- SAE J844 Type A & B nylon tubing

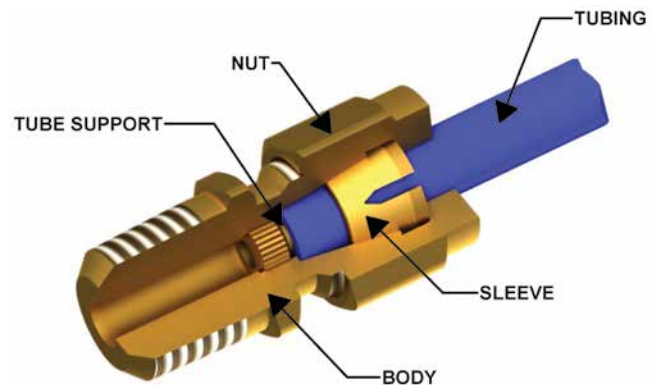

## Assembly Instructions

1. Cut tubing squarely and remove burrs
2. Insert tubing into fitting until bottomed
3. Tighten nut 1 1/2 turns from finger tight



**WARNING** These products can expose you to chemicals including LEAD which is known to the state of California to cause cancer and birth defects or other reproductive harm. For more information go to [www.P65Warnings.ca.gov](http://www.P65Warnings.ca.gov).



Click here for CADs, Product Specifications or to Configure Parts Online

- A
- B
- C
- D
- E
- F
- G
- H
- I
- J
- K
- L
- M
- N
- O

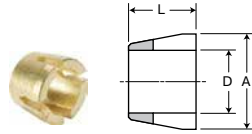

**Sleeve 60TF**

PART NO.	TUBE SIZE	A	D	L
60TF-2	1/8	.235	.130	0.17
60TF-5/32	5/32	.251	.165	0.18

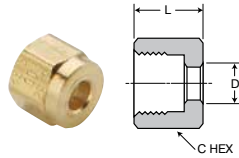

**Nut 61TF**

PART NO.	TUBE SIZE	D	L	STRT THD	C HEX
61TF-2	1/8	.133	.32	5/16-24	3/8
61TF-5/32	5/32	.163	.32	5/16-24	3/8

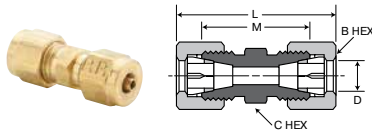

**Union 62TF**

PART NO.	TUBE SIZE	D	L	STRT THD	M	C HEX	B HEX
62TF-2	1/8	.109	1.04	5/16-24	.68	5/16	3/8
62TF-5/32	5/32	.068	1.04	5/16-24	.68	5/16	3/8

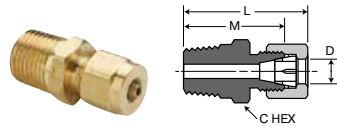

**Male Connector 68TF**

PART NO.	TUBE SIZE	PIPE THREAD	D	L	STRT THD	M	C HEX
68TF-2-1	1/8	1/16	.109	.96	5/16-24	.78	11/32
68TF-2-2	1/8	1/8	.109	.96	5/16-24	.78	7/16
68TF-5/32-1	5/32	1/16	.068	.84	5/16-24	.66	11/32
68TF-5/32-2	5/32	1/8	.068	.96	5/16-24	.78	7/16

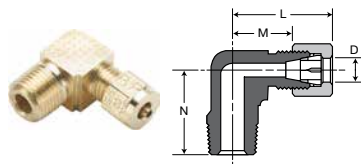

**Male Elbow 269TF**

PART NO.	TUBE SIZE	PIPE THREAD	D	L	STRT THD	M	N
269TF-2-2	1/8	1/8	.109	.79	5/16-24	.61	.66
269TF-5/32-2	5/32	1/8	.068	.79	5/16-24	.61	.66

**WARNING** These products can expose you to chemicals including LEAD which is known to the state of California to cause cancer and birth defects or other reproductive harm. For more information go to [www.P65Warnings.ca.gov](http://www.P65Warnings.ca.gov).

- A
- B
- C
- D
- E
- F
- G
- H
- I
- J
- K
- L
- M
- N
- O



# Air Brake – AB Fittings

Parker's Air Brake – AB Fittings are economical compression style fittings for copper air brake lines. AB fittings meet the functional requirements of SAE and the performance requirements of D.O.T.

## Product Features:

- Brass Body
- Meets D.O.T. FMVSS571.106 Performance
- Meets functional Requirements SAE J246
- Reusable
- Pre-applied Thread Sealant

## Markets:

- Heavy Duty Truck
- Trailer
- Mobile

## Applications:

- Copper Air Brake Lines
- Coolant Lines
- Fuel Lines

## Specifications:

**Pressure Range** Up to 400 PSI (27.5 bar)

**Temperature Range** -65° to +250° F (-53.8° to +121.1° C)

## Compatible Tubing:

- Copper Air Brake Tubing

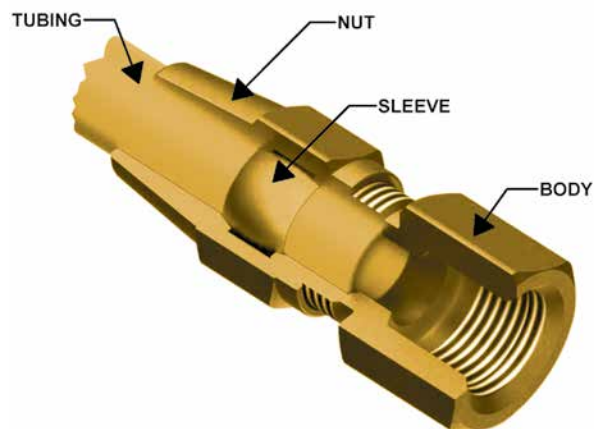

## Assembly Instructions

1. Cut tubing squarely and remove burrs
2. Slide nut and sleeve onto tubing.
3. Insert tubing into fitting until bottomed on seat. The nut should be screwed down finger tight, then wrench tightened as indicated in the chart



TUBE SIZE	TURNS REQUIRED TO SEAL FROM HAND-TIGHT
1/4, 3/8, 1/2	2
5/8, 3/4	3

**WARNING** These products can expose you to chemicals including LEAD which is known to the state of California to cause cancer and birth defects or other reproductive harm. For more information go to [www.P65Warnings.ca.gov](http://www.P65Warnings.ca.gov).



Click here for CADs, Product Specifications or to Configure Parts Online

- A
- B
- C
- D
- E
- F
- G
- H
- I
- J
- K
- L
- M
- N
- O

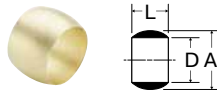

**Sleeve 60AB**  
REF. SAE 120115

PART NO.	TUBE SIZE	A	D	L
60AB-4	1/4	.322	.255	.250
60AB-6	3/8	.461	.382	.310
60AB-8	1/2	.594	.507	.380
60AB-10	5/8	.734	.632	.440
60AB-12	3/4	.874	.758	.500

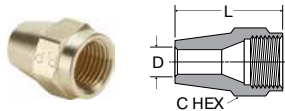

**Female Connector 66AB**  
REF. SAE 120103 BA

PART NO.	TUBE SIZE	PIPE THREAD	STRAIGHT THREAD	C HEX	L	M	FLOW DIA. D
66AB-4-2	1/4	1/8	7/16-24	9/16	1.42	.84	.188
66AB-4-4	1/4	1/4	7/16-24	11/16	1.65	1.07	.188
66AB-6-2	3/8	1/8	17/32-24	9/16	1.89	1.00	.314
66AB-6-4	3/8	1/4	17/32-24	11/16	2.07	1.18	.314
66AB-6-6	3/8	3/8	17/32-24	7/8	2.07	1.18	.314
66AB-8-6	1/2	3/8	11/16-20	7/8	2.23	1.27	.408
66AB-8-8	1/2	1/2	11/16-20	1-1/16	2.40	1.44	.408
66AB-10-6	5/8	3/8	13/16-18	7/8	2.40	1.31	.533
66AB-10-8	5/8	1/2	13/16-18	1-1/16	2.59	1.50	.533

**Nut 61AB**  
REF. SAE 120111

PART NO.	TUBE SIZE	STRAIGHT THREAD	C HEX	D	L
61AB-4	1/4	7/16-24	9/16	.256	.75
61AB-6	3/8	17/32-24	5/8	.384	1.13
61AB-8	1/2	11/16-20	13/16	.509	1.25
61AB-10	5/8	13/16-18	15/16	.634	1.38
61AB-12	3/4	1-18	1-1/8	.760	1.56

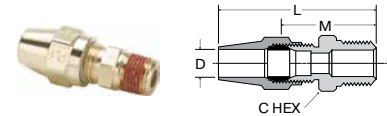

**Male Connector VS68AB**  
REF. SAE 120102 BA

PART NO.	TUBE SIZE	PIPE THREAD	STRAIGHT THREAD	C HEX	L	M	FLOW DIA. D
VS68AB-4-2	1/4	1/8	7/16-24	7/16	1.47	.89	.189
VS68AB-4-4	1/4	1/4	7/16-24	9/16	1.68	1.10	.189
VS68AB-4-6	1/4	3/8	7/16-24	11/16	1.72	1.14	.189
VS68AB-6-2	3/8	1/8	17/32-24	9/16	1.92	1.03	.189
VS68AB-6-4	3/8	1/4	17/32-24	9/16	2.10	1.21	.314
VS68AB-6-6	3/8	3/8	17/32-24	11/16	2.13	1.24	.314
VS68AB-6-8	3/8	1/2	17/32-24	7/8	2.32	1.43	.314
VS68AB-8-4	1/2	1/4	11/16-20	11/16	2.29	1.33	.314
VS68AB-8-6	1/2	3/8	11/16-20	11/16	2.29	1.33	.408
VS68AB-8-8	1/2	1/2	11/16-20	7/8	2.48	1.52	.408
VS68AB-10-6	5/8	3/8	13/16-18	13/16	2.48	1.39	.408
VS68AB-10-8	5/8	1/2	13/16-18	7/8	2.67	1.58	.533
VS68AB-12-8	3/4	1/2	1-18	1	2.92	1.68	.533
VS68AB-12-12	3/4	3/4	1-18	1-1/8	2.95	1.71	.658

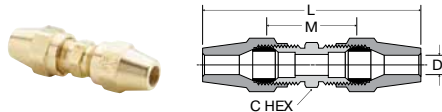

**Union 62AB**  
REF. SAE 120101 BA

PART NO.	TUBE SIZE	STRAIGHT THREAD	C HEX	L	M	FLOW DIA. D
62AB-4	1/4	7/16-24	7/16	1.98	.83	.189
62AB-6	3/8	17/32-24	9/16	2.87	1.08	.314
62AB-8	1/2	11/16-20	11/16	3.21	1.29	.405
62AB-10	5/8	13/16-18	13/16	3.59	1.41	.531
62AB-12	3/4	1-18	1	4.08	1.59	.656

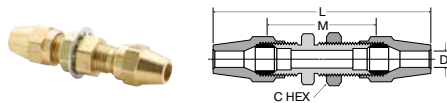

**Bulkhead Union 62ABH**

PART NO.	TUBE SIZE	STRAIGHT THREAD	C HEX	L	M	FLOW DIA. D	BULKHEAD HOLE DIA.
62ABH-4	1/4	7/16-24	9/16	2.53	1.38	.188	7/16
62ABH-6	3/8	17/32-24	3/4	3.41	1.62	.314	17/32
62ABH-8	1/2	11/16-20	1	3.80	1.88	.408	11/16

**WARNING** These products can expose you to chemicals including LEAD which is known to the state of California to cause cancer and birth defects or other reproductive harm. For more information go to [www.P65Warnings.ca.gov](http://www.P65Warnings.ca.gov).



Click here for CADs, Product Specifications or to Configure Parts Online

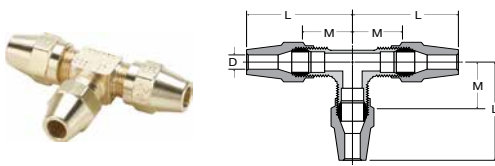

### Union Tee 264AB

REF. SAE 120401 BA

PART NO.	TUBE SIZE	STRAIGHT THREAD	L	M	FLOW DIA. D
264AB-4	1/4	7/16-24	1.20	.62	.189
264AB-6	3/8	17/32-24	1.67	.78	.314
264AB-8	1/2	11/16-20	1.89	.93	.408
264AB-10	5/8	13/16-18	2.18	1.09	.533

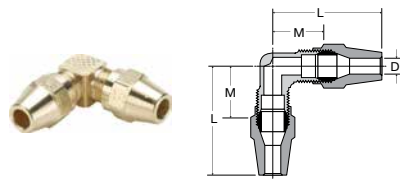

### Union Elbow 265AB

REF. SAE 120201 BA

PART NO.	TUBE SIZE	STRAIGHT THREAD	L	M	FLOW DIA. D
265AB-4	1/4	7/16-24	1.20	.62	.189
265AB-6	3/8	17/32-24	1.68	.79	.314
265AB-8	1/2	11/16-20	1.89	.93	.408
265AB-10	5/8	13/16-18	2.18	1.09	.533

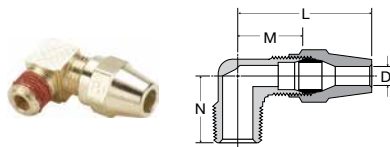

### Male Elbow VS269AB

REF. SAE 120202 BA

PART NO.	TUBE SIZE	PIPE THREAD	STRAIGHT THREAD	L	M	N	FLOW DIA. D
VS269AB-4-2	1/4	1/8	7/16-24	1.20	.62	.66	.189
VS269AB-4-4	1/4	1/4	7/16-24	1.26	.68	.87	.189
VS269AB-4-6	1/4	3/8	7/16-24	1.31	.73	.86	.189
VS269AB-6-2	3/8	1/8	17/32-24	1.62	.73	.75	.189
VS269AB-6-4	3/8	1/4	17/32-24	1.68	.79	.92	.314
VS269AB-6-6	3/8	3/8	17/32-24	1.73	.84	.91	.314
VS269AB-6-8	3/8	1/2	17/32-24	1.83	.94	1.10	.314
VS269AB-8-4	1/2	1/4	11/16-20	1.82	.86	.99	.314
VS269AB-8-6	1/2	3/8	11/16-20	1.88	.93	.99	.408
VS269AB-8-8	1/2	1/2	11/16-20	1.99	1.03	1.18	.408
VS269AB-10-6	5/8	3/8	13/16-18	2.09	1.00	1.05	.408
VS269AB-10-8	5/8	1/2	13/16-18	2.18	1.09	1.24	.533
VS269AB-12-8	3/4	1/2	1-18	2.33	1.19	1.32	.533
VS269AB-12-12	3/4	3/4	1-18	2.50	1.26	1.32	.533

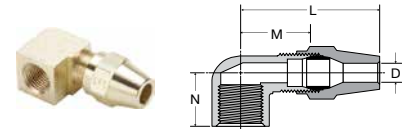

### Female Elbow 270AB

REF. SAE 120203 BA

PART NO.	TUBE SIZE	PIPE THREAD	STRAIGHT THREAD	L	M	N	FLOW DIA. D
270AB-4-2	1/4	1/8	7/16-24	1.27	.69	.52	.189
270AB-4-4	1/4	1/4	7/16-24	1.36	.78	.71	.189
270AB-6-2	3/8	1/8	17/32-24	1.72	.83	.59	.314
270AB-6-4	3/8	1/4	17/32-24	1.78	.89	.77	.314
270AB-6-6	3/8	3/8	17/32-24	1.82	.93	.77	.314
270AB-8-6	1/2	3/8	11/16-20	1.99	1.03	.82	.408
270AB-8-8	1/2	1/2	11/16-20	2.09	1.13	1.01	.408
270AB-10-8	5/8	1/2	13/16-18	2.28	1.19	1.07	.533

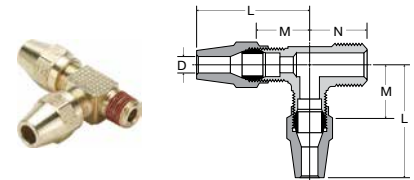

### Male Run Tee VS271AB

REF. SAE 120424 BA

PART NO.	TUBE SIZE	PIPE THREAD	STRAIGHT THREAD	L	M	N	FLOW DIA. D
VS271AB-4-2	1/4	1/8	7/16-24	1.20	.62	.66	.189
VS271AB-4-4	1/4	1/4	7/16-24	1.26	.68	.87	.189
VS271AB-6-4	3/8	1/4	17/32-24	1.68	.79	.92	.314
VS271AB-6-6	3/8	3/8	17/32-24	1.73	.84	.91	.314
VS271AB-8-6	1/2	3/8	11/16-20	1.89	.93	.99	.408
VS271AB-8-8	1/2	1/2	11/16-20	1.99	1.03	1.18	.408
VS271AB-10-8	5/8	1/2	13/16-18	2.18	1.09	1.24	.533

**WARNING** These products can expose you to chemicals including LEAD which is known to the state of California to cause cancer and birth defects or other reproductive harm. For more information go to [www.P65Warnings.ca.gov](http://www.P65Warnings.ca.gov).



Click here for CADs, Product Specifications or to Configure Parts Online

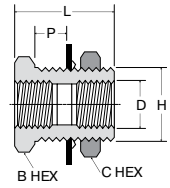
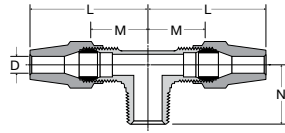

### Male Branch Tee VS272AB

REF. SAE 120425 BA

PART NO.	TUBE SIZE	PIPE THREAD	STRAIGHT THREAD	L	M	N	FLOW DIA. D
VS272AB-4-2	1/4	1/8	7/16-24	1.20	.62	.66	.189
VS272AB-4-4	1/4	1/4	7/16-24	1.26	.68	.87	.189
VS272AB-6-2	3/8	1/8	17/32-24	1.61	.72	.75	.189
VS272AB-6-4	3/8	1/4	17/32-24	1.68	.79	.92	.314
VS272AB-6-6	3/8	3/8	17/32-24	1.73	.84	.91	.314
VS272AB-8-6	1/2	3/8	11/16-20	1.89	.93	.99	.408
VS272AB-8-8	1/2	1/2	11/16-20	1.99	1.03	1.18	.408
VS272AB-10-8	5/8	1/2	13/16-18	2.18	1.09	1.24	.533

### Anchor Coupling 207ACBH

PART NO.	FEMALE PIPE THREAD	STRAIGHT THREAD	MAX .BKHD P	B HEX	C HEX	L	BKHD HOLE DIA. H	FLOW DIA. D
207ACBH-2	1/8	5/8-18	.89	7/8	15/16	1.50	5/8	.339
207ACBHS-2	1/8	5/8-18	.35	7/8	15/16	.96	5/8	.339
207ACBH-4	1/4	3/4-16	.81	1	1-1/8	1.50	3/4	.441
207ACBHS-4	1/4	3/4-16	.26	1	1	.94	3/4	.441
207ACBH-6	3/8	1-14	.62	1-1/8	1-1/4	1.31	1	.571
207ACBH-8	1/2	1-1/8-14	.75	1-1/4	1-3/8	1.50	1-1/8	.703
207ACBH-12	3/4	1-5/16-12	.65	1-1/2	1-1/2	1.50	1-5/16	.906
207ACBH-16*	1	1-5/8-14	1.00	2	2	1.68	1-5/8	1.140

\*Lock Washer not Available

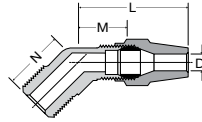

### 45° Elbow VS279AB

REF. SAE 120302 BA

PART NO.	TUBE SIZE	PIPE THREAD	STRAIGHT THREAD	L	M	N	FLOW DIA. D
VS279AB-4-2	1/4	1/8	7/16-24	1.07	.49	.63	.189
VS279AB-4-4	1/4	1/4	7/16-24	1.18	.60	.85	.189
VS279AB-6-2	3/8	1/8	17/32-24	1.60	.71	.68	.189
VS279AB-6-4	3/8	1/4	17/32-24	1.64	.71	.85	.314
VS279AB-6-6	3/8	3/8	17/32-24	1.64	.75	.94	.314
VS279AB-6-8	3/8	1/2	17/32-24	1.67	.78	1.16	.314
VS279AB-8-6	1/2	3/8	11/16-20	1.80	.84	.94	.408
VS279AB-8-8	1/2	1/2	11/16-20	1.83	.87	1.16	.408
VS279AB-10-6	5/8	3/8	13/16-18	2.03	.94	.98	.408
VS279AB-10-8	5/8	1/2	13/16-18	2.13	1.05	1.16	.533
VS279AB-12-8	3/4	1/2	1-18	2.34	1.10	1.18	.533

**WARNING** These products can expose you to chemicals including LEAD which is known to the state of California to cause cancer and birth defects or other reproductive harm. For more information go to [www.P65Warnings.ca.gov](http://www.P65Warnings.ca.gov).



# Air Brake Hose Ends Fittings



Parker's Air Brake Hose Fittings are field attachable fittings for use with Parker 271 air brake hose. Easy to assemble and disassemble, these fittings meet D.O.T. requirements when used with SAE J1402 air brake hose.

## Product Features:

- Brass Body
- Meets D.O.T. FMVSS571.106 when used with SAE J1402 air brake hose

## Markets:

- Heavy Duty Truck
- Trailer

## Applications:

- Air Lines Frame to Axle

## Specifications:

**Pressure Range** Up to 400 PSI (27.5 bar)

**Temperature Range** -65° to +250° F (-53.8° to +121.1° C)

## Compatible Tubing:

- Parker 271 air brake hose
- SAE J1402 air brake hose

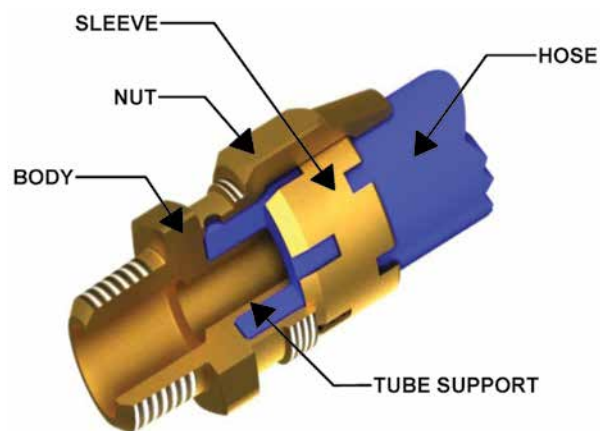

## Assembly Instructions

1. Slide nut onto hose
2. Slide sleeve onto hose with tapered edge toward fitting body
3. Bottom hose into fitting
4. Tighten nut until it contacts body hex



Note: When reassembling fitting, body and nut should be inspected. Only reuse if parts are in proper condition. Sleeves should never be Reused.

**WARNING** These products can expose you to chemicals including NICKEL or LEAD, which are known to the state of California to cause cancer, and LEAD which is known to cause birth defects or other reproductive harm. For more information go to [www.P65Warnings.ca.gov](http://www.P65Warnings.ca.gov).



A

B

C

D

E

F

G

H

I

J

K

L

M

N

O

[Click here for CADs, Product Specifications or to Configure Parts Online](#)

- A
- B
- C
- D
- E
- F
- G
- H
- I
- J
- K
- L
- M
- N
- O

### Spring 56RBSG

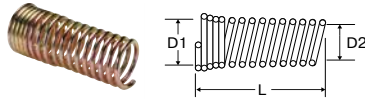

PART NO.	HOSE SIZE	L	D1	D2
56RBSG-6	3/8	2.75	.84	.78
56RBSG-8	1/2	3.00	1.03	.91

### Air Brake Hose Nut & Attached Spring 67RBSG

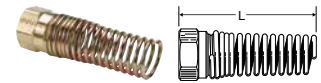

PART NO.	L
67RBSG-6	3.50
67RBSG-8	3.75

### Sleeve 60RB

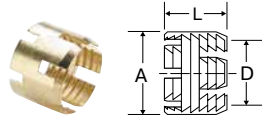

PART NO.	HOSE SIZE	L	A	D
60RB-6	3/8	.69	.90	.78
60RB-8	1/2	.69	1.03	.92

### Male Connector 68RB

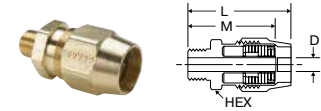

PART NO.	HOSE SIZE	STRAIGHT THREAD	PIPE THREAD	HEX	L	M	D
68RB-6-4	3/8	31/32-20	1/4	31/32	2.24	1.91	.281
68RB-6-6	3/8	31/32-20	3/8	31/32	2.24	1.91	.281
68RB-6-8	3/8	31/32-20	1/2	31/32	2.38	2.06	.281
68RB-8-6	1/2	1-3/32-20	3/8	1-1/8	2.24	1.91	.390
68RB-8-8	1/2	1-3/32-20	1/2	1-1/8	2.29	2.07	.390

### Nut 61RB

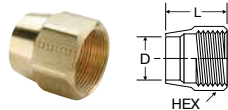

PART NO.	HOSE SIZE	STRAIGHT THREAD	HEX	L	D
61RB-6	3/8	31/32-20	1-1/16	1.12	.80
61RB-8	1/2	1-3/32-20	1-1/4	1.12	.93

### Male Connector Body Only 68RB

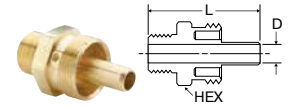

PART NO.	HOSE SIZE	STRAIGHT THREAD	PIPE THREAD	HEX	L	D
68RB-6-4B	3/8	31/32-20	1/4	31/32	1.91	.281
68RB-6-6B	3/8	31/32-20	3/8	31/32	1.91	.281
68RB-6-8B	3/8	31/32-20	1/2	31/32	2.06	.281
68RB-8-6B	1/2	1-3/32-20	3/8	1-1/8	1.91	.390
68RB-8-8B	1/2	1-3/32-20	1/2	1-1/8	2.07	.390

### Spring Guard Nut 61RBSG

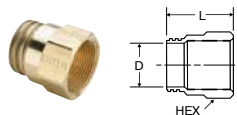

PART NO.	HOSE SIZE	STRAIGHT THREAD	HEX	L	D
61RBSG-6	3/8	31/32-20	1-1/16	1.22	.80
61RBSG-8	1/2	1-3/32-20	1-1/4	1.19	.92

### Male Connector with Spring Guard 68RBSG

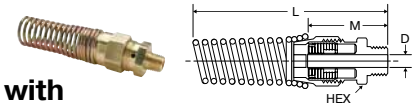

PART NO.	HOSE SIZE	PIPE THREAD	HEX	L	M	D
68RBSG-6-4	3/8	1/4	31/32	4.8	1.91	.281
68RBSG-6-6	3/8	3/8	31/32	4.8	1.91	.281
68RBSG-6-8	3/8	1/2	31/32	4.9	2.06	.281
68RBSG-8-6	1/2	3/8	1-1/8	5.0	1.91	.390
68RBSG-8-8	1/2	1/2	1-1/8	5.2	2.07	.390

### Union 62RB

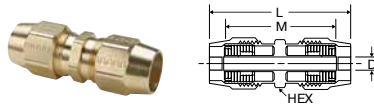

PART NO.	HOSE SIZE	STRAIGHT THREAD	HEX	L	M	D
62RB-6	3/8	31/32-20	31/32	2.98	2.56	.281
62RB-8	1/2	1-3/32-20	1-1/8	2.99	2.55	.390

### Adapter 76RB

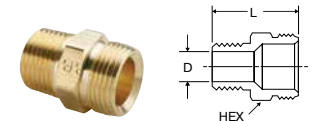

PART NO.	PIPE THREAD	STRAIGHT THREAD	HEX	L	D
76RB-3/4-4	1/4	3/4-20	3/4	1.06	.310
76RB-3/4-6	3/8	3/4-20	3/4	1.12	.422
76RB-7/8-6	3/8	7/8-20	7/8	1.25	.440
76RB-7/8-8	1/2	7/8-20	7/8	1.47	.500

### Female Swivel Connector 66RBSV

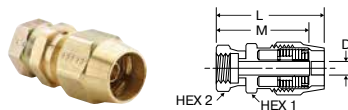

PART NO.	HOSE SIZE	STRAIGHT THREAD	HEX1	HEX2	L	M	D
66RBSV-6-3/4	3/8	3/4-20	31/32	7/8	2.30	2.09	.281
66RBSV-8-7/8	1/2	7/8-20	1-1/8	1"	2.36	2.14	.390

**WARNING** These products can expose you to chemicals including NICKEL or LEAD, which are known to the state of California to cause cancer, and LEAD which is known to cause birth defects or other reproductive harm. For more information go to [www.P65Warnings.ca.gov](http://www.P65Warnings.ca.gov).





# Vibra-Lok Fittings



Parker's Vibra-Lok Fittings provide a positive reliable seal under vibration conditions, mechanical shock or tube movement. The sleeve cushions the tubing, permitting the tubing to flex back and forth in the fitting. The seal design compensates for tube misalignment and tube surface defects.

## Product Features:

- Brass Body
- Sleeves in Buna N and Fluorocarbon
- NPTF and SAE J1926 Straight Threads are Standard
- Excellent Vibration Resistance

## Markets:

- Heavy Duty Truck
- Trailer
- Mobile

## Applications:

- Oil, Fuel and Coolant Lines on engines

## Specifications:

### Pressure Range

Dependent on condition and tube size, refer to pressure chart

### Temperature Range

-15° to +450° F (-26.1° to +232.2° C) with Fluorocarbon Sleeve

-30° to +275° F (-34.4° to +135° C) with Buna N Sleeve

## Compatible Tubing:

- Copper
- Aluminum
- Steel (Bundy)
- Stainless Steel
- Glass

## Pressure Chart

CONDITION	TUBE O.D.	TUBE NOT BELLED	TUBE BELLED OR FLARED
STATIC PRESSURE	1/8"	500	1000
	3/16"	500	1000
	1/4"	500	1000
	5/16"	450	900
	3/8"	350	700
	1/2"	200	500
MINOR SURGES AND/OR VIBRATIONS	1/8"	400	800
	3/16"	400	800
	1/4"	400	800
	5/16"	325	700
	3/8"	225	500
	1/2"	150	375
SEVERE VIBRATIONS OR SHOCK	1/8"	300	600
	3/16"	300	600
	1/4"	300	600
	5/16"	225	500
	3/8"	175	400
	1/2"	100	250
	5/8"		100

In high pressure applications and sizes larger than 1/2" O.D., the tube end should be belled or flared.

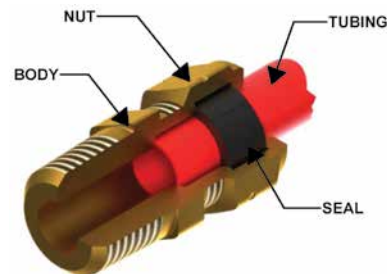

**WARNING** These products can expose you to chemicals including CARBON BLACK, or LEAD, which are known to the state of California to cause cancer, and LEAD which is known to cause birth defects or other reproductive harm. For more information go to [www.P65Warnings.ca.gov](http://www.P65Warnings.ca.gov).



[Click here for CADs, Product Specifications or to Configure Parts Online](#)

### Assembly Instructions

1. Cut the tubing squarely removing burrs
2. Slip nut and sleeve over tube
3. Bottom tubing into fitting and tighten nut until stop is reached. The elastic sleeve ordinarily will extrude slightly around the tube at the end of the nut. This extrusion further aids in isolating the tube from the nut.

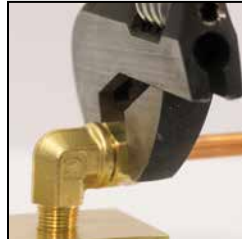

### For Higher Pressure applications

4. Consult pressure chart to determine if tubing should be belled
5. Slip nut and sleeve over tube. The sleeve should be positioned near end of tubing just behind the surface to be belled
6. Bell tubing with standard 45° flaring tool or 90° punch. The size of bell should be approximately that shown.



### Recommended Size of Bell

TUBE O.D.	BELL DIA. C
1/8	.190-.160
3/16	.255-.225
1/4	.318-.288
5/16	.381-.351
3/8	.444-.414
1/2	.569-.539
5/8	.694-.664
3/4	.819-.789
7/8	.944-.914

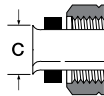

### Tube Length Calculator

This table shows distance tube extends beyond face of Vibra-Lok fitting body on installation with bell on tubing and without bell on tubing.

O.D. OF TUBE	A WITH BELL	B WITHOUT BELL
1/8	3/16	3/16
3/16	3/16	7/32
1/4	3/16	1/4
5/16	3/16	1/4
3/8	3/16	1/4
1/2	3/16	11/32
5/8	3/16	TUBING SHOULD BE BELLED
3/4	3/16	TUBING SHOULD BE BELLED
7/8	1/4	TUBING SHOULD BE BELLED

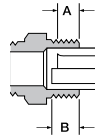

### Sleeve 60VL



PART NO.	TUBE SIZE	A	D	L
60VL-2	1/8	.306	.100	.20
60VL-3	3/16	.359	.156	.20
60VL-4	1/4	.422	.219	.21
60VL-5	5/16	.484	.281	.24
60VL-6	3/8	.547	.344	.25
60VL-8	1/2	.688	.469	.36
60VL-10	5/8	.875	.594	.48
60VL-12	3/4	1.000	.720	.59

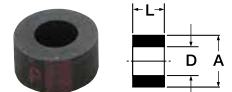

### Sleeve (Fluorocarbon) 60VLV

PART NO.	TUBE SIZE	A	D	L
60VLV-3	3/16	.359	.156	.20
60VLV-4	1/4	.422	.219	.21
60VLV-5	5/16	.484	.281	.24
60VLV-6	3/8	.547	.344	.25
60VLV-8	1/2	.688	.469	.36
60VLV-10	5/8	.875	.594	.48
60VLV-12	3/4	1.000	.720	.59

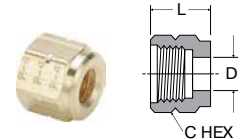

### Nut 61VL

PART NO.	TUBE SIZE	STRAIGHT THREAD	C HEX	D	L
61VL-2	1/8	3/8-24	7/16	.156	.44
61VL-3	3/16	7/16-24	1/2	.218	.47
61VL-4	1/4	1/2-24	9/16	.281	.50
61VL-5	5/16	9/16-24	5/8	.344	.53
61VL-6	3/8	5/8-24	3/4	.406	.53
61VL-8	1/2	13/16-18	15/16	.531	.67
61VL-10	5/8	1-18	1-1/8	.656	.88
61VL-12	3/4	1-1/8-18	1-1/4	.781	.98

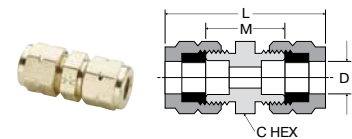

### Union 62VL

PART NO.	TUBE SIZE	C HEX	L	M	FLOW DIA. D
62VL-4	1/4	9/16	1.39	.77	.188
62VL-5	5/16	5/8	1.49	.81	.250
62VL-6	3/8	11/16	1.49	.80	.312
62VL-8	1/2	7/8	1.90	.94	.437

**WARNING** These products can expose you to chemicals including CARBON BLACK, or LEAD, which are known to the state of California to cause cancer, and LEAD which is known to cause birth defects or other reproductive harm. For more information go to [www.P65Warnings.ca.gov](http://www.P65Warnings.ca.gov).



Click here for CADs, Product Specifications or to Configure Parts Online

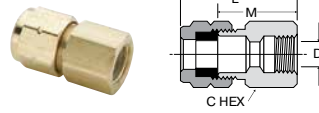

### Female Connector 66VL

PART NO.	TUBE SIZE	PIPE THREAD	C HEX	L	M	FLOW DIA. D
66VL-4-2	1/4	1/8	9/16	1.09	.78	.188
66VL-5-4	5/16	1/4	11/16	1.32	.97	.250

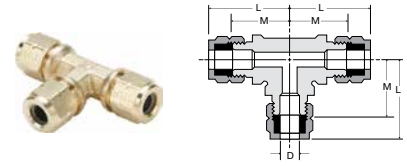

### Union Tee 164VL

PART NO.	TUBE SIZE	BODY HEX	L	M	FLOW DIA. D
164VL-3	3/16	3/8	.98	.69	.160
164VL-4	1/4	1/2	1.06	.75	.190
164VL-5	5/16	15/32	1.22	.88	.250
164VL-8	1/2	13/16	1.64	1.16	.406

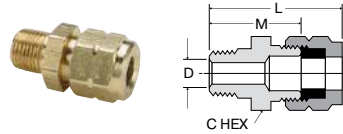

### Male Connector 68VL

PART NO.	TUBE SIZE	PIPE THREAD	C HEX	L	M	FLOW DIA. D
68VL-2-2	1/8	1/8	7/16	1.12	.81	.093
68VL-3-2	3/16	1/8	1/2	1.10	.81	.125
68VL-4-2	1/4	1/8	9/16	1.15	.84	.188
68VL-4-4	1/4	1/4	9/16	1.34	1.03	.188
68VL-5-4	5/16	1/4	5/8	1.41	1.06	.250
68VL-6-2	3/8	1/8	11/16	1.22	.87	.235
68VL-6-4	3/8	1/4	11/16	1.41	1.06	.312
68VL-6-6	3/8	3/8	11/16	1.41	1.06	.312
68VL-8-6	1/2	3/8	7/8	1.64	1.16	.406
68VL-8-8	1/2	1/2	7/8	1.64	1.35	.406
68VL-10-8	5/8	1/2	1-1/16	2.10	1.44	.560
68VL-12-8	3/4	1/2	1-3/16	2.26	1.50	.530
68VL-12-12	3/4	3/4	1-3/16	2.26	1.50	.688

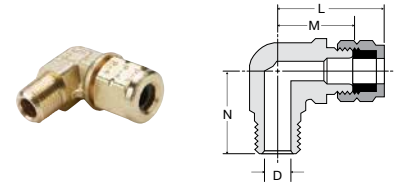

### Male Elbow 169VL

PART NO.	TUBE SIZE	PIPE THREAD	L	M	N	FLOW DIA. D
169VL-3-2	3/16	1/8	.98	.69	.75	.156
169VL-4-2	1/4	1/8	1.00	.69	.78	.188
169VL-4-4	1/4	1/4	1.16	.84	1.00	.188
169VL-5-4	5/16	1/4	1.16	.81	1.00	.252
169VL-6-2	3/8	1/8	1.19	.84	.91	.235
169VL-6-4	3/8	1/4	1.19	.84	1.06	.312
169VL-6-6	3/8	3/8	1.29	.94	1.13	.312
169VL-8-6	1/2	3/8	1.48	1.00	1.06	.406
169VL-8-8	1/2	1/2	1.54	1.06	1.44	.406
169VL-10-8	5/8	1/2	1.92	1.28	1.47	.565

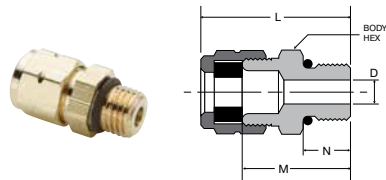

### Male Connector 685VLV

PART NO.	TUBE SIZE	STRAIGHT THREAD	BODY HEX	L	M	N	D
685VLV-4-4	1/4	7/16-20	9/16	1.14	.83	.36	.18
685VLV-5-4	5/16	7/16-20	5/8	1.18	.83	.36	.18
685VLV-6-4	3/8	7/16-20	11/16	1.18	.83	.36	.18
685VLV-6-6	3/8	9/16-18	11/16	1.25	.90	.39	.30
685VLV-8-8	1/2	3/4-16	7/8	1.52	1.04	.44	.39
685VLV-10-10	5/8	7/8-14	1 1/16	1.84	1.20	.50	.50
685VLV-12-12	3/4	1 1/16-12	1 1/4	2.10	1.34	.59	.62

Note: Fluorocarbon seal & o-ring standard

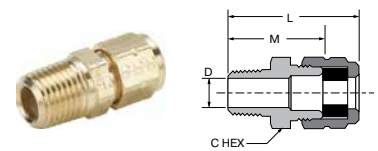

### Straight Through Tank Fitting 682VL

PART NO.	TUBE SIZE	PIPE THREAD	C HEX	L	M	FLOW DIA. D
682VL-4-2	1/4	1/8	9/16	1.15	.84	.265
682VL-4-4	1/4	1/4	9/16	1.34	1.03	.265
682VL-5-4	5/16	1/4	5/8	1.41	1.06	.328
682VL-6-6	3/8	3/8	11/16	1.41	1.06	.406

**WARNING** These products can expose you to chemicals including CARBON BLACK, or LEAD, which are known to the state of California to cause cancer, and LEAD which is known to cause birth defects or other reproductive harm. For more information go to [www.P65Warnings.ca.gov](http://www.P65Warnings.ca.gov).



- A
- B
- C
- D
- E
- F
- G
- H
- I
- J
- K
- L
- M
- N
- O

Click here for CADs, Product Specifications or to Configure Parts Online

- A
- B
- C
- D
- E
- F
- G
- H
- I
- J
- K
- L
- M
- N
- O

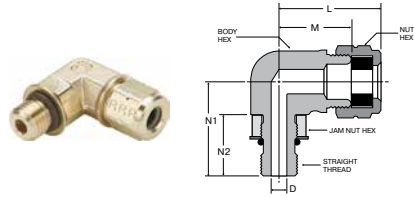

**Male Elbow 1695VLV**

PART NO.	TUBE SIZE	STRAIGHT THREAD	NUT HEX	BODY HEX	JAM NUT HEX	L	M	N1	N2	D
1695VLV-4-4	1/4	7/16-20	9/16	9/16	9/16	1.15	.84	1.07	.71	.18
1695VLV-5-4	5/16	7/16-20	5/8	9/16	9/16	1.16	.81	1.07	.71	.18
1695VLV-6-4	3/8	7/16-20	3/4	5/8	9/16	1.19	.84	1.10	.71	.18
1695VLV-6-6	3/8	9/16-18	3/4	5/8	11/16	1.29	.94	1.17	.78	.30
1695VLV-8-8	1/2	3/4-16	15/16	3/4	7/8	1.54	1.06	1.44	.89	.39
1695VLV-10-10	5/8	7/8-14	1 1/8	1.00	1.00	1.92	1.28	1.68	1.03	.50
1695VLV-12-12	3/4	1 1/16-12	1 1/4	1.00	1 1/4	2.04	1.28	1.82	1.17	.62

Note: Fluorocarbon seal & o-ring standard

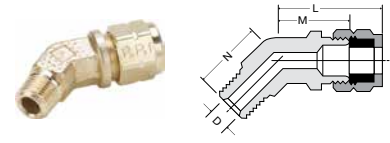

**45° Elbow 179VL**

PART NO.	TUBE SIZE	PIPE THREAD	L	M	N	FLOW DIA. D
179VL-4-2	1/4	1/8	1.06	.75	.69	.188
179VL-6-4	3/8	1/4	1.07	.72	.84	.315

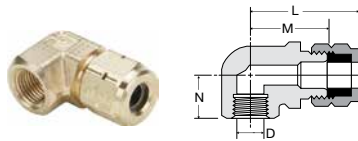

**Female Elbow 170VL**

PART NO.	TUBE SIZE	PIPE THREAD	L	M	N	FLOW DIA. D
170VL-4-2	1/4	1/8	.96	.65	.50	.188
170VL-5-4	5/16	1/4	1.16	.81	.70	.250

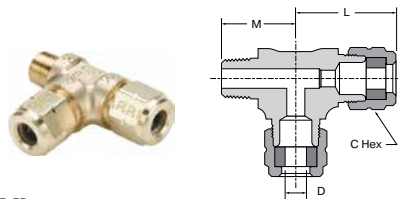

**Male Run Tee 171VL**

PART NO.	TUBE SIZE	PIPE THREAD	C HEX	L	M	FLOW DIA. D
171VL-4-2	1/4	1/8	9/16	1.03	.76	.188
171VL-4-4	1/4	1/4	9/16	1.12	1.03	.188

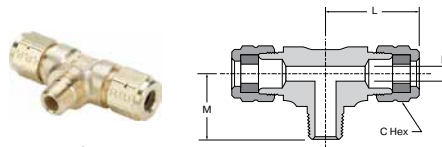

**Male Branch Tee 172VL**

PART NO.	TUBE SIZE	PIPE THREAD	C HEX	L	M	FLOW DIA. D
172VL-4-2	1/4	1/8	9/16	1.06	.75	.188

**WARNING** These products can expose you to chemicals including CARBON BLACK, or LEAD, which are known to the state of California to cause cancer, and LEAD which is known to cause birth defects or other reproductive harm. For more information go to [www.P65Warnings.ca.gov](http://www.P65Warnings.ca.gov).



# Truck Valves & Lanyard Valve



Parker's Truck Valves have metal-to-metal seats with fine thread screwdown. Parker's Lanyard Valves' compact design is ideally suited for releasing condensate from air tanks.

## Product Features:

### Truck Valves

- Brass Body and Stem
- Flare, Hose, Tube and Pipe Connections
- Round and Pin Handles

### Lanyard Valve

- Low Temperature Seal
- All Brass Body
- Manual Release

### Markets:

- Heavy Duty Truck
- Trailer
- Mobile

### Applications:

- Water
- Oil
- Coolant lines

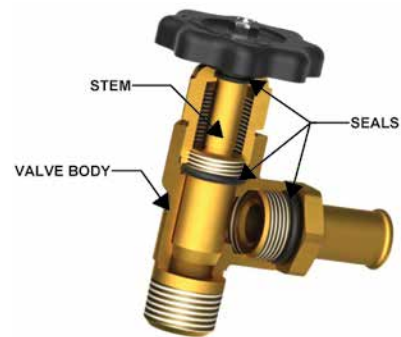

## Truck Valve Specifications:

**Pressure Range** Up to 150 PSI (10.3 bar)

**Temperature Range** -30° to +250° F (-34.4° to +121.1° C)

## Lanyard Valve Specifications:

**Pressure Range** Up to 150 PSI (10.3 bar)

**Temperature Range** -40° to +200° F (-40° to +93.3° C)

## Lanyard Valve Operating Instructions

A pulling action exerted on the cable cocks the stem, allowing condensate to pass through the valve. Releasing the cable resets the stem which returns the valve to its closed position.

**WARNING** These products can expose you to chemicals including LEAD which is known to the state of California to cause cancer and birth defects or other reproductive harm. For more information go to [www.P65Warnings.ca.gov](http://www.P65Warnings.ca.gov).



A

B

C

D

E

F

G

H

I

J

K

L

M

N

O

A

B

C

D

E

F

G

H

I

J

K

L

M

N

O

### Truck Valve V404P

Hose to Male Pipe  
Temperature Range: -30° to +250° F (-34.4° to +121.1° C)

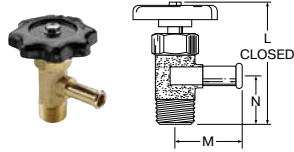

PART NO.	HOSE I.D.	PIPE THREAD	FLOW	L	M	N
V404P-6-6	3/8	3/8	.281	2.35	1.36	.94
V404P-10-6	5/8	3/8	.406	2.75	1.31	1.10

### Truck Valve V404PH

Hose to Male Pipe with Pin Handle  
Temperature Range: -30° to +250° F (-34.4° to +121.1° C)

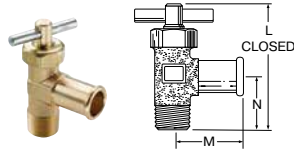

PART NO.	HOSE I.D.	PIPE THREAD	FLOW	L	M	N
V404PH-10-6	5/8	3/8	.406	2.47	1.31	1.10

### Truck Valve SV404P

Hose to Male Pipe  
Temperature Range: -30° to +250° F (-34.4° to +121.1° C)

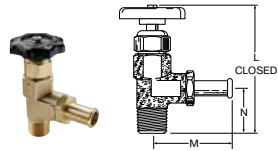

PART NO.	HOSE I.D.	PIPE THREAD	FLOW	L	M	N
SV404P-10-8	5/8	1/2	.468	3.71	2.31	1.34
SV404P-12-6	3/4	3/8	.438	3.73	2.31	1.34
SV404P-12-8	3/4	1/2	.562	3.73	2.31	1.34

### Truck Valve V405P

Female Pipe to Male Pipe  
Temperature Range: -30° to +250° F (-34.4° to +121.1° C)

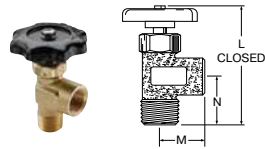

PART NO.	FEMALE PIPE THREAD	MALE PIPE THREAD	FLOW	L	M	N
V405P-6-6	3/8	3/8	.406	2.72	.91	1.19
V405P-6-8	3/8	1/2	.406	2.95	.91	1.31
V405P-8-8	1/2	1/2	.562	3.15	1.17	1.34

### Truck Valve V408NTA

Tube to Male Pipe  
Temperature Range: -30° to +250° F (-34.4° to +121.1° C)

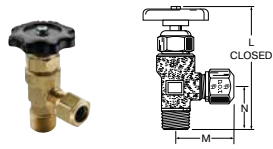

PART NO.	TUBE SIZE	PIPE THREAD	FLOW	L	M	N
V408NTA-8-8	1/2	1/2	.328	3.28	1.15	1.19

### Truck Valve V409F

Flare to Male Pipe  
Temperature Range: -30° to +250° F (-34.4° to +121.1° C)

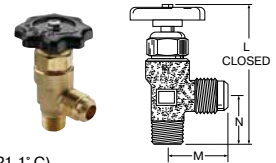

PART NO.	TUBE SIZE	PIPE THREAD	FLOW	L	M	N
V409F-8-6	1/2	3/8	.406	3.07	1.31	1.00
V409F-8-8	1/2	1/2	.406	3.28	1.31	1.19
V409F-10-8	5/8	1/2	.500	3.47	1.50	1.25
V409F-12-8	3/4	1/2	.562	3.70	2.31	1.34

### Truck Valve V410NTA

Tube to Male Pipe  
Temperature Range: -30° to +250° F (-34.4° to +121.1° C)

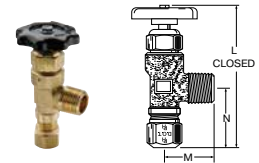

F PART NO.	TUBE SIZE	PIPE THREAD	FLOW	L	M	N
V410NTA-8-8	1/2	1/2	.328	3.58	1.38	1.31

### Truck Valve V412F

Tube to Male Pipe  
Temperature Range: -30° to +250° F (-34.4° to +121.1° C)

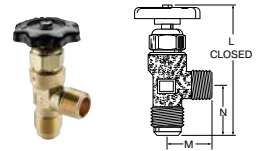

PART NO.	TUBE SIZE	PIPE THREAD	FLOW	L	M	N
V412F-10-8	5/8	1/2	.500	3.60	1.38	1.31

### Lanyard Valve LV91

Temperature Range: -40° to +200° F (-40° to +93.3° C)

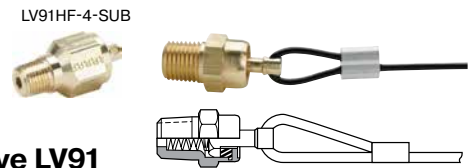

PART NO.	PIPE THREAD	CABLE LENGTH INCHES
LV91-4-036	1/4	36
LV91-4-048	1/4	48
LV91-4-060	1/4	60
LV91HF-4-SUB	1/4	--

**WARNING** These products can expose you to chemicals including LEAD which is known to the state of California to cause cancer and birth defects or other reproductive harm. For more information go to [www.P65Warnings.ca.gov](http://www.P65Warnings.ca.gov).





# Industrial Compression Style Fittings

Compression Fittings

Compress-Align<sup>®</sup> Fittings

Brass Metric Compression

Poly-Tite Fittings

Hi-Duty Flareless Tube Fittings







**■ Compression Fittings**

**60C**  
Sleeve  
p. G8



**60PT**  
Plastic Sleeve  
p. G8



**61C**  
Nut  
p. G8



**61CL**  
Long Nut  
p. G8



**62C**  
Union  
p. G8



**62CBH**  
Bulkhead Union  
p. G9



**63PT**  
Tube Support  
p. G9, G13



**66C**  
Female Connector  
NPT  
p. G9



**68C**  
Male Connector  
NPTF  
p. G9



**164C-264C**  
Union Tee  
p. G10



**165C-265C**  
Union Elbow  
p. G10



**169C-269C**  
Male Elbow  
NPTF  
p. G10



**170C-270C**  
Female Elbow  
NPT  
p. G11



**171C**  
Male Run Tee  
NPTF  
p. G11



**172C**  
Male Branch Tee  
NPTF  
p. G11



**176C**  
Adaptor  
NPTF  
p. G11



**177C**  
Female Branch Tee  
NPT  
p. G11



**179C**  
45° Male Elbow  
NPTF  
p. G11



**639C**  
Seal Plug  
p. G11



**682C**  
Tank Fitting  
NPTF  
p. G11



**■ Compress-Align® Fittings**

**59CA**  
Plug  
p. G13



**61CA**  
Nut/Sleeve  
p. G13



**62CA**  
Union  
p. G13



**62CABH**  
Bulkhead Union  
p. G13



**62PCA**  
Union  
p. G13



**62PCABH**  
Bulkhead Union  
p. G13



**63PT**  
Tube Support  
p. G9, G14



**66CA**  
Female Connector  
NPT  
p. G14



**68CA**  
Male Connector  
NPTF  
p. G14



**164CA-264CA**  
Union Tee  
p. G15



**165CA-265CA**  
Union Elbow  
p. G15



**169CA-269CA**  
Male Elbow  
NPTF  
p. G15



**170CA-270CA**  
Female Elbow  
NPT  
p. G16



**171CA**  
Male Run Tee  
NPTF  
p. G16



**172CA**  
Male Branch Tee  
NPTF  
p. G16



**176CA**  
Adaptor  
NPTF  
p. G16



**177CA**  
Female Branch Tee  
NPT  
p. G16



**179CA**  
45° Male Elbow  
NPTF  
p. G16



**639CA**  
Seal Plug  
p. G16



**682CA**  
Tank Fitting  
NPTF  
p. G16



**⚠** WARNING These products can expose you to chemicals including NICKEL or LEAD, which are known to the state of California to cause cancer, and LEAD which is known to cause birth defects or other reproductive harm. For more information go to [www.P65Warnings.ca.gov](http://www.P65Warnings.ca.gov).

**Brass Metric Compression Fittings**

**0105**  
Male Connector  
NPT, BSPT  
p. G18



**0101**  
Male Elbow  
BSPP, Straight  
p. G18, G19



**0114**  
Female Connector  
BSPP  
p. G20



**0109**  
Male Elbow  
NPT, BSPT  
p. G20, G21



**0199**  
Male Elbow  
BSPP  
p. G21



**0108**  
Male Branch Tee  
BSPT  
p. G21



**0103**  
Male Run Tee  
BSPT  
p. G22



**0118**  
Single Banjo  
p. G22, G23



**0119**  
Double Banjo  
p. G22, G23



**0106**  
Union  
p. G23



**0116**  
Bulkhead Union  
p. G23



**0102**  
Union Elbow  
p. G24



**0104**  
Union Tee  
p. G24



**0107**  
Union Cross  
p. G24



**0142**  
Union Y  
p. G24



**0124**  
Metric Sleeve  
p. G25



**0111**  
Metric Sleeve  
p. G25



**0110**  
Metric Nut  
p. G25



**0110 60**  
Metric Nut  
p. G25



**0110 70**  
Metric Nut Sleeve  
p. G27



**0125**  
Metric End Plug  
p. G27



**0220**  
Metric Male Plug  
p. G27



**0168**  
Reducer  
BSPP  
p. G27



**0127**  
Metric Tube  
Support  
p. G27



**Poly-Tite Fittings**

**56PSG**  
Spring guard  
p. G29



**59P**  
Plug  
p. G29



**60P**  
Plastic Sleeve  
p. G29



**60PB**  
Brass Sleeve  
p. G29



**61P**  
Nut/Plastic Sleeve  
p. G29



**61PB**  
Nut/Brass Sleeve  
p. G29



**61PN**  
Nut Only  
p. G29



**61PSGN**  
Spring Guard Nut  
p. G29



**62P**  
Union  
p. G29, G30



**62PBH**  
Bulkhead Union  
p. G30



**62PCA**  
Union  
p. G30



**62PCABH**  
Bulkhead Union  
p. G30



**62PTBH**  
Bulkhead Union  
p. G30



**66P**  
Female Connector  
NPT  
p. G30



**68P**  
Male Connector  
NPTF  
p. G31



**97P**  
Tube Reducer  
p. G31



**391P**  
Coupler Body  
p. G31



**391PSS**  
Coupler Body  
p. G31



**392P**  
Bulkhead Body  
p. G31



**392PSS**  
Bulkhead Body  
p. G31



**393P**  
Through Insert  
p. G31



**WARNING** These products can expose you to chemicals including NICKEL or LEAD, which are known to the state of California to cause cancer, and LEAD which is known to cause birth defects or other reproductive harm. For more information go to [www.P65Warnings.ca.gov](http://www.P65Warnings.ca.gov).













- A
- B
- C
- D
- E
- F
- G
- H
- I
- J
- K
- L
- M
- N
- O

- A
- B
- C
- D
- E
- F
- G
- H
- I
- J
- K
- L
- M
- N
- O

<p><b>393PSS</b> Through Insert p. G31</p> 	<p><b>393PD</b> Shutoff Insert p. G32</p> 	<p><b>393PDSS</b> Shutoff Insert p. G32</p> 	<p><b>394P</b> Single Shutoff p. G32</p> 	<p><b>394PSS</b> Single Shutoff p. G32</p> 	<p><b>394PD</b> Double Shutoff p. G32</p> 	<p><b>394PDSS</b> Double Shutoff p. G32</p> 
<p><b>398P</b> Single Shutoff p. G32</p> 	<p><b>398PSS</b> Single Shutoff p. G32</p> 	<p><b>398PD</b> Double Shutoff p. G33</p> 	<p><b>398PDSS</b> Double Shutoff p. G33</p> 	<p><b>164P</b> Union Tee p. G33</p> 	<p><b>169P-269P</b> Male Elbow NPTF p. G33</p> 	<p><b>169LP</b> Long Elbow NPTF p. G33</p> 
<p><b>169PS</b> Male Elbow Swivel NPTF p. G33</p> 	<p><b>170P</b> Female Elbow NPT p. G34</p> 	<p><b>171P</b> Male Run Tee NPTF p. G34</p> 	<p><b>172P</b> Male Branch Tee NPTF p. G34</p> 	<p><b>177P</b> Female Branch Tee NPT p. G34</p> 	<p><b>NV311P</b> Needle Valve NPTF p. G34</p> 	<p><b>NV312P</b> Needle Valve NPTF p. G34</p> 

**Hi-Duty Flareless Tube Fittings**

<p><b>62HDBH</b> Bulkhead Union p. G36</p> 	<p><b>61HD</b> Nut p. G36</p> 	<p><b>62HD</b> Union p. G36</p> 	<p><b>62HD</b> Reducing Union p. G36</p> 	<p><b>164HD</b> Union Tee p. G36</p> 	<p><b>165HD</b> Union Elbow p. G36</p> 
<p><b>66HD</b> Female Connector NPT p. G36</p> 	<p><b>68HD</b> Male Connector NPTF p. G37</p> 	<p><b>169HD</b> Male Elbow NPTF p. G37</p> 	<p><b>170HD</b> Female Elbow NPT p. G37</p> 	<p><b>171HD</b> Male Run Tee NPTF p. G37</p> 	<p><b>172HD</b> Male Branch Tee NPTF p. G37</p> 
<p><b>179HD</b> 45° Male Elbow NPTF p. G37</p> 	<p><b>177HD</b> Female Branch Tee NPT p. G38</p> 	<p><b>59HD</b> Plug p. G38</p> 			

**WARNING** These products can expose you to chemicals including NICKEL or LEAD, which are known to the state of California to cause cancer, and LEAD which is known to cause birth defects or other reproductive harm. For more information go to [www.P65Warnings.ca.gov](http://www.P65Warnings.ca.gov).



# Compression Fittings

Parker's Compression Fittings provide users with an economical choice with numerous connection options for a wide variety of tube materials without the need for flaring, soldering or other tube preparation necessary to assemble.

### Product Features:

- Meets functional requirements of SAE J-512
- UL Listed for flammable liquid
- Brass or acetal sleeve available
- No tube preparation
- Forged and extruded shapes

### Markets:

- Industrial
- Packaging
- Pneumatic
- Printing

### Applications:

- Air lines
- Lubrication Lines
- Cooling lines
- Industry
- Machinery
- Compressors
- Fluid transfer

### Compatible Tubing:

- Copper
- Aluminum
- Thermoplastic tubing

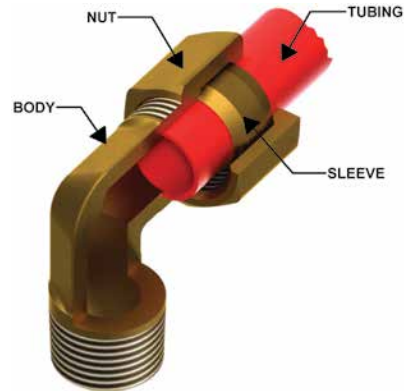

### Assembly Instructions

1. Slide nut then sleeve onto tubing. The thread end of the nut must face out.
2. Insert tube and bottom on the fitting shoulder
3. Assemble nut to body and tighten "hand tight". Then wrench tighten the number of turns indicated in the table.

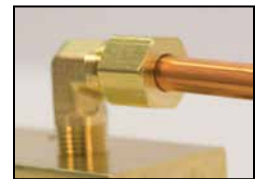

### Specifications:

**Temperature Range:** -65° to +250° F (- 53.8° to +121.1° C)

### Pressure Range:

TUBE SIZE	PSI	bar	TUBE SIZE	PSI	bar
1/8	2800	193.0	7/16	900	62.05
3/16	1900	131.0	1/2	750	51.7
1/4	1400	96.5	5/8	650	44.8
5/16	1200	82.7	3/4	550	37.9
3/8	1000	68.9	7/8	450	24.1

Note: Pressures listed in above table are with brass sleeve and copper tubing

FITTING SIZE	TUBE SIZE	TURNS REQUIRED TO SEAL FROM HAND-TIGHT	
		60C WITH SOFT METAL TUBING	60PT WITH THERMOPLASTIC TUBING
2	1/8	1-1/4	—
3	3/16	1-1/4	—
4	1/4	1-1/4	2
5	5/16	1-1/4	2
6	3/8	2-1/4	2
7	7/16	2-1/4	—
8	1/2	2-1/4	2
10	5/8	2-1/4	2
12	3/4	2-1/4	2
14	7/8	2-1/4	—

**WARNING** These products can expose you to chemicals including LEAD which is known to the state of California to cause cancer and birth defects or other reproductive harm. For more information go to [www.P65Warnings.ca.gov](http://www.P65Warnings.ca.gov).



[Click here for CADs, Product Specifications or to Configure Parts Online](#)

- A
- B
- C
- D
- E
- F
- G
- H
- I
- J
- K
- L
- M
- N
- O

### Sleeve 60C

REF. SAE 060115

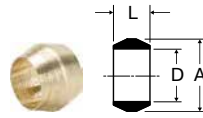

PART NO.	TUBE SIZE	A	D	L
60C-2	1/8	.187	.130	.19
60C-3	3/16	.266	.192	.22
60C-4	1/4	.344	.255	.25
60C-5	5/16	.406	.318	.25
60C-6	3/8	.469	.382	.25
60C-7	7/16	.531	.444	.31
60C-8	1/2	.594	.507	.38
60C-10	5/8	.719	.632	.38
60C-12	3/4	.875	.758	.44
60C-14	7/8	1.000	.883	.41

### Acetal Sleeve 60PT

PART NO.	PLASTIC TUBE WALL	TUBE WALL	A	D	L
60PT-4	1/4	.040	.375	.254	.19
60PT-5	5/16	.062	.438	.317	.19
60PT-6	3/8	.062	.500	.379	.19
60PT-8	1/2	.062	.631	.507	.25
60PT-10	5/8	.062	.747	.632	.22

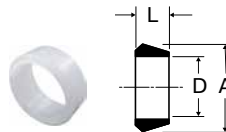

### Nut 61C

REF. SAE 060110

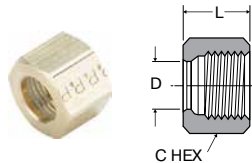

PART NO.	TUBE SIZE	STRAIGHT THREAD	C HEX	D	L
61C-2	1/8	5/16-24	3/8	.130	.38
61C-3	3/16	3/8-24	7/16	.192	.41
61C-4	1/4	7/16-24	1/2	.255	.44
61C-5	5/16	1/2-24	9/16	.318	.44
61C-6	3/8	9/16-24	5/8	.382	.47
61C-7	7/16	5/8-24	11/16	.444	.50
61C-8	1/2	11/16-20	13/16	.507	.62
61C-10	5/8	13/16-18	15/16	.632	.62
61C-12	3/4	1-18	1-3/16	.758	.69
61C-14	7/8	1-1/8-18	1-1/4	.890	.62

### Long Nut 61CL

REF. SAE 060111

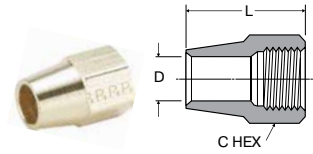

PART NO.	TUBE SIZE	STRAIGHT THREAD	C HEX	D	L
61CL-4	1/4	7/16-24	1/2	.255	.75
61CL-5	5/16	1/2-24	9/16	.318	.84
61CL-6	3/8	9/16-24	5/8	.382	.97
61CL-8	1/2	11/16-20	13/16	.507	1.06
61CL-10	5/8	13/16-18	15/16	.632	1.19
61CL-12	3/4	1-18	1-3/16	.758	1.38

### Union 62C

REF. SAE 060101 BA

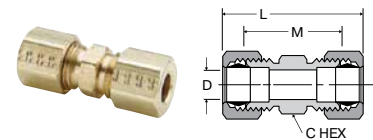

PART NO.	TUBE SIZE	STRAIGHT THREAD	C HEX	L	M	FLOW DIA. D
62C-2	1/8	5/16-24	5/16	1.05	.64	.094
62C-3	3/16	3/8-24	3/8	1.21	.72	.125
62C-4	1/4	7/16-24	7/16	1.33	.79	.188
62C-5	5/16	1/2-24	1/2	1.39	.85	.250
62C-6	3/8	9/16-24	9/16	1.52	.97	.312
62C-7	7/16	5/8-24	5/8	1.70	1.02	.312
62C-8	1/2	11/16-20	11/16	1.90	1.08	.406
62C-10	5/8	13/16-18	13/16	2.06	1.23	.500
62C-12	3/4	1-18	1	2.37	1.41	.562
62C-14	7/8	1-1/8-18	1-1/8	2.07	1.19	.766

### Union Reducers 62C

REF. SAE 060101 BA

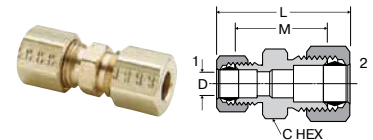

PART NO.	1 TUBE SIZE	2 TUBE SIZE	1 STRAIGHT THREAD	2 STRAIGHT THREAD	C HEX	L	M	FLOW DIA. D
62C-4-3	3/16	1/4	3/8-24	7/16-24	7/16	1.29	.78	.125
62C-6-4	1/4	3/8	7/16-24	9/16-24	9/16	1.46	.91	.188
62C-8-6	3/8	1/2	9/16-24	11/16-20	11/16	1.71	1.03	.312
62C-10-6	3/8	5/8	9/16-24	13/16-18	13/16	1.82	1.13	.312

**WARNING** These products can expose you to chemicals including LEAD which is known to the state of California to cause cancer and birth defects or other reproductive harm. For more information go to [www.P65Warnings.ca.gov](http://www.P65Warnings.ca.gov).

[Click here for CADs, Product Specifications or to Configure Parts Online](#)

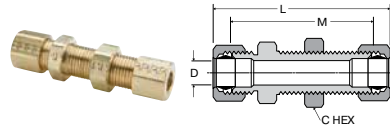

**Bulkhead Union 62CBH**

PART NO.	TUBE SIZE	STRAIGHT THREAD	C HEX	L	M	BULKHEAD HOLE DIA.	FLOW DIA. D
62CBH-4	1/4	7/16-24	9/16	2.29	1.75	7/16	.188
62CBH-6	3/8	9/16-24	11/16	2.42	1.88	9/16	.312

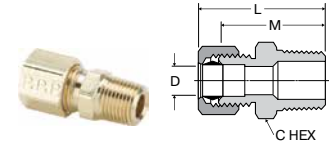

**Male Connector 68C**

REF. SAE 060102 BA

PART NO.	TUBE SIZE	PIPE THREAD	STRAIGHT THREAD	C HEX	L	M	FLOW DIA. D
68C-2-1	1/8	1/16	5/16-24	3/8	.99	.78	.095
68C-2-2	1/8	1/8	5/16-24	7/16	.97	.77	.094
68C-3-1	3/16	1/16	3/8-24	3/8	1.08	.84	.125
68C-3-2	3/16	1/8	3/8-24	7/16	1.08	.84	.125
68C-3-4	3/16	1/4	3/8-24	9/16	1.27	1.03	.125
68C-4-2	1/4	1/8	7/16-24	7/16	1.10	.86	.188
68C-4-4	1/4	1/4	7/16-24	9/16	1.30	1.06	.188
68C-4-6	1/4	3/8	7/16-24	11/16	1.27	1.03	.188
68C-4-8	1/4	1/2	7/16-24	7/8	1.55	1.31	.188
68C-5-2	5/16	1/8	1/2-24	1/2	1.15	.89	.234
68C-5-4	5/16	1/4	1/2-24	9/16	1.33	1.07	.250
68C-6-2	3/8	1/8	9/16-24	9/16	1.25	.97	.250
68C-6-4	3/8	1/4	9/16-24	9/16	1.42	1.14	.312
68C-6-6	3/8	3/8	9/16-24	11/16	1.44	1.16	.312
68C-6-8	3/8	1/2	9/16-24	7/8	1.53	1.25	.312
68C-7-4	7/16	1/4	5/8-24	5/8	1.50	1.17	.312
68C-8-4	1/2	1/4	11/16-20	11/16	1.60	1.20	.312
68C-8-6	1/2	3/8	11/16-20	11/16	1.60	1.20	.406
68C-8-8	1/2	1/2	11/16-20	7/8	1.71	1.31	.406
68C-10-6	5/8	3/8	13/16-18	13/16	1.73	1.31	.406
68C-10-8	5/8	1/2	13/16-18	7/8	1.90	1.48	.500
68C-10-12	5/8	3/4	13/16-18	1-1/16	1.98	1.56	.500
68C-12-8	3/4	1/2	1-18	1	2.05	1.60	.562
68C-12-12	3/4	3/4	1-18	1-1/16	2.08	1.63	.656
68C-14-12	7/8	3/4	1-1/8-18	1-1/8	1.76	1.41	.750

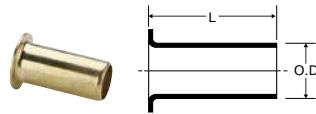

**Brass Insert 63PT**

PART NO.	TUBE O.D.	TUBE WALL	L	O.D.
63PT-2-16	1/8	.016	.46	.080
63PT-2-23	1/8	.023	.45	.073
63PT-3-25	3/16	.025	.45	.135
63PT-3-40	3/16	.040	.52	.095
63NTA-4*	1/4		.53	.163
63PT-4-62	1/4	.062	.33	.110
63PT-5-40	5/16	.040	.50	.232
63PT-5-62	5/16	.062	.53	.187
63NTA-6*	3/8		.64	.245
63NTA-8*	1/2		.81	.370
63PT-10-62	5/8	.062	.72	.483

\* Denotes 304 stainless steel

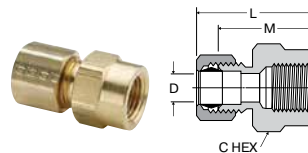

**Female Connector 66C**

REF. SAE 060103 BA

PART NO.	TUBE SIZE	PIPE THREAD	STRAIGHT THREAD	C HEX	L	M	FLOW DIA. D
66C-2-2	1/8	1/8	5/16-24	9/16	.95	.75	.094
66C-3-2	3/16	1/8	3/8-24	9/16	1.02	.78	.125
66C-3-4	3/16	1/4	3/8-24	11/16	1.20	.96	.125
66C-4-2	1/4	1/8	7/16-24	9/16	1.02	.78	.188
66C-4-4	1/4	1/4	7/16-24	11/16	1.24	1.00	.188
66C-5-2	5/16	1/8	1/2-24	9/16	1.07	.81	.250
66C-5-4	5/16	1/4	1/2-24	11/16	1.29	1.03	.250
66C-6-2	3/8	1/8	9/16-24	9/16	1.06	.78	.312
66C-6-4	3/8	1/4	9/16-24	11/16	1.34	1.06	.312
66C-6-6	3/8	3/8	9/16-24	13/16	1.34	1.06	.312
66C-6-8	3/8	1/2	9/16-24	1	1.54	1.27	.312
66C-7-6	7/16	3/8	5/8-24	13/16	1.43	1.09	.312
66C-8-4	1/2	1/4	11/16-20	11/16	1.49	1.09	.406
66C-8-6	1/2	3/8	11/16-20	13/16	1.52	1.12	.406
66C-8-8	1/2	1/2	11/16-20	1	1.71	1.31	.406
66C-10-8	5/8	1/2	13/16-18	1	1.80	1.38	.500

**WARNING** These products can expose you to chemicals including LEAD which is known to the state of California to cause cancer and birth defects or other reproductive harm. For more information go to [www.P65Warnings.ca.gov](http://www.P65Warnings.ca.gov).



Click here for CADs, Product Specifications or to Configure Parts Online

A  
B  
C  
D  
E  
F  
G  
H  
I  
J  
K  
L  
M  
N  
O

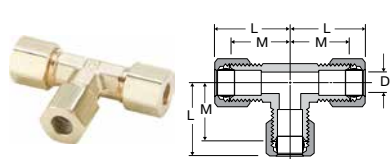

**Union Tee  
164C-264C**

REF. SAE 060401 BA

PART NO.	TUBE SIZE	STRAIGHT THREAD	L	M	FLOW DIA. D
164C-2	1/8	5/16-24	.82	.61	.094
264C-3	3/16	3/8-24	.84	.60	.125
164C-4	1/4	7/16-24	.86	.63	.188
264C-4	1/4	7/16-24	.84	.60	.188
164C-5	5/16	1/2-24	.98	.71	.250
164C-6	3/8	9/16-24	1.03	.74	.312
164C-8	1/2	11/16-20	1.34	.93	.406
164C-10	5/8	13/16-18	1.54	1.08	.500
164C-12	3/4	1.00-18	1.65	1.17	.563

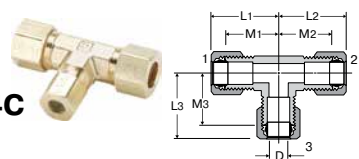

**Union Tee 164C-264C  
Combination Sizes**

REF. SAE 060401 BA

PART NO.	1 TUBE SIZE	2 TUBE SIZE	3 TUBE SIZE	L1	L2	L3	M1	M2	M3	FLOW DIA. D
164C-6-4-4	3/8	1/4	1/4	1.03	.96	.96	.75	.72	.72	.188
164C-6-6-4	3/8	3/8	1/4	1.03	.96	.96	.75	.75	.72	.188
164C-8-8-6	1/2	1/2	3/8	1.34	1.16	1.16	.94	.94	.88	.312

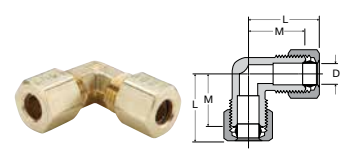

**Union Elbow  
165C-265C**

REF. SAE 060201 BA

PART NO.	TUBE SIZE	STRAIGHT THREAD	L	M	FLOW DIA. D
165C-2	1/8	5/16-24	.82	.61	.094
165C-3	3/16	3/8-24	.87	.61	.125
165C-4	1/4	7/16-24	.88	.61	.188
265C-4	1/4	7/16-24	.84	.60	.188
165C-5	5/16	1/2-24	.95	.71	.250
165C-6	3/8	9/16-24	1.03	.74	.312
165C-7	7/16	5/3-24	1.16	.82	.312
165C-8	1/2	11/16-20	1.34	.93	.406
165C-10	5/8	13/16-18	1.48	1.05	.500
165C-12	3/4	1-18	1.65	1.17	.563

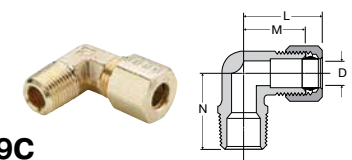

**Male Elbow 169C-269C**

REF. SAE 060202 BA

PART NO.	TUBE SIZE	PIPE THREAD	STRAIGHT THREAD	L	M	N	FLOW DIA. D
169C-2-1	1/8	1/16	5/16-24	.81	.60	.67	.095
269C-2-2	1/8	1/8	5/16-24	.80	.60	.67	.094
169C-3-1	3/16	1/16	3/8-24	.85	.61	.67	.126
169C-3-2	3/16	1/8	3/8-24	.84	.61	.69	.125
269C-3-2	3/16	1/8	3/8-24	.84	.60	.67	.125
169C-3-4	3/16	1/4	3/8-24	.86	.64	.93	.125
169C-4-2	1/4	1/8	7/16-24	.86	.61	.74	.188
269C-4-2	1/4	1/8	7/16-24	.84	.60	.73	.188
169C-4-4	1/4	1/4	7/16-24	.86	.62	.94	.188
269C-4-4	1/4	1/4	7/16-24	.84	.60	.79	.188
169C-4-6	1/4	3/8	7/16-24	.93	.68	1.00	.188
169C-5-2*	5/16	1/8	1/2-24	.88	.61	.74	.234
269C-5-2*	5/16	1/8	1/2-24	.86	.60	.73	.250
169C-5-4	5/16	1/4	1/2-24	.95	.71	.93	.250
269C-5-4	5/16	1/4	1/2-24	.93	.67	.82	.250
169C-5-6	5/16	3/8	1/2-24	1.01	.75	1.00	.250
169C-6-2*	3/8	1/8	9/16-24	1.03	.74	.74	.234
269C-6-2*	3/8	1/8	9/16-24	.97	.69	.75	.220
169C-6-4	3/8	1/4	9/16-24	1.03	.74	.93	.312
269C-6-4	3/8	1/4	9/16-24	1.01	.73	.92	.312
169C-6-6	3/8	3/8	9/16-24	1.03	.75	1.00	.312
269C-6-6	3/8	3/8	9/16-24	1.12	.84	.97	.312
169C-6-8	3/8	1/2	9/16-24	1.22	.94	1.27	.312
269C-7-6	7/16	3/8	5/8-24	1.16	.82	.98	.312
169C-8-4*	1/2	1/4	11/16-20	1.34	.94	1.00	.312
169C-8-6	1/2	3/8	11/16-20	1.34	.93	1.11	.406
169C-8-8	1/2	1/2	11/16-20	1.48	1.00	1.37	.406
169C-10-8	5/8	1/2	13/16-18	1.48	1.06	1.31	.500
169C-12-8	3/4	1/2	1-18	1.64	1.18	1.49	.562
169C-12-12	3/4	3/4	1-18	1.70	1.27	1.58	.562

\* For these parts the pipe thread through hole is smaller than the through hole on the flare end.

**WARNING** These products can expose you to chemicals including LEAD which is known to the state of California to cause cancer and birth defects or other reproductive harm. For more information go to [www.P65Warnings.ca.gov](http://www.P65Warnings.ca.gov).





[Click here for CADs, Product Specifications or to Configure Parts Online](#)

### Female Elbow 170C-270C

REF. SAE 060203 BA

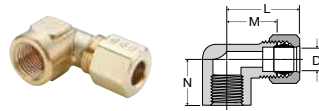

PART NO.	TUBE SIZE	PIPE THREAD	STRAIGHT THREAD	L	M	N	FLOW DIA. D
170C-2-2	1/8	1/8	5/16-24	.89	.69	.56	.094
170C-3-2	3/16	1/8	3/8-24	.98	.69	.56	.125
170C-4-2	1/4	1/8	7/16-24	.93	.69	.56	.188
270C-4-2	1/4	1/8	7/16-24	.91	.67	.54	.188
170C-4-4	1/4	1/4	7/16-24	1.02	.78	.67	.188
170C-6-4	3/8	1/4	9/16-24	1.06	.79	.73	.312
170C-6-6	3/8	3/8	9/16-24	1.22	.89	.69	.312
170C-7-4	7/16	1/4	5/8-24	1.27	.93	.73	.312
170C-8-6	1/2	3/8	11/16-20	1.34	1.00	.69	.406
170C-8-8	1/2	1/2	11/16-20	1.56	1.15	.97	.408
170C-12-12	3/4	3/4	1-18	2.06	1.58	1.58	.563

### Adapter Tee 176C

PART NO.	TUBE SIZE	PIPE THREAD	STRAIGHT THREAD	L	M	N	N1	FLOW DIA. D
176C-4-2	1/4	1/8	7/16-24	.93	.69	.75	.66	.188

### Female Branch Tee 177C

PART NO.	TUBE SIZE	PIPE THREAD	STRAIGHT THREAD	L	M	N	FLOW DIA. D
177C-4-2	1/4	1/8	7/16-24	.86	.63	.53	.188

### Male Run Tee 171C

REF. SAE 060424 BA

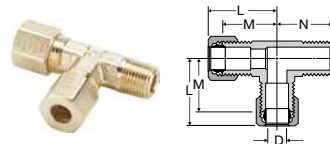

PART NO.	TUBE SIZE	PIPE THREAD	STRAIGHT THREAD	L	M	N	FLOW DIA. D
171C-2-2	1/8	1/8	5/16-24	.82	.61	.67	.094
171C-3-2	3/16	1/8	3/8-24	.86	.61	.67	.125
171C-4-2	1/4	1/8	7/16-24	.90	.64	.75	.188
171C-4-4	1/4	1/4	7/16-24	.93	.69	.92	.188
171C-6-4	3/8	1/4	9/16-24	1.09	.81	1.03	.312

### 45° Elbow 179C

Compression to male pipe

PART NO.	TUBE SIZE	PIPE THREAD	STRAIGHT THREAD	L	M	N	FLOW DIA. D
179C-4-2	1/4	1/8	7/16-24	.90	.66	.56	.188
179C-4-4	1/4	1/4	7/16-24	.80	.56	.84	.188
179C-6-2	3/8	1/8	9/16-24	.90	.63	.65	.234
179C-6-4	3/8	1/4	9/16-24	.90	.63	.84	.312
179C-6-6	3/8	3/8	9/16-24	.97	.75	.95	.312
179C-8-6	1/2	3/8	11/16-20	1.15	.81	.95	.406

### Male Branch Tee 172C

REF. SAE 060425 BA

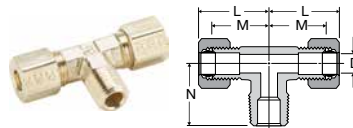

PART NO.	TUBE SIZE	PIPE THREAD	STRAIGHT THREAD	L	M	N	FLOW DIA. D
172C-2-2	1/8	1/8	5/16-24	.82	.61	.67	.094
172C-3-2	3/16	1/8	3/8-24	.86	.61	.67	.125
172C-4-2	1/4	1/8	7/16-24	.86	.61	.74	.188
172C-4-4	1/4	1/4	7/16-24	.93	.69	.92	.188
172C-6-2	3/8	1/8	9/16-24	1.03	.75	.75	.234
172C-6-4	3/8	1/4	9/16-24	1.09	.77	.92	.312
172C-6-6	3/8	3/8	9/16-24	1.09	.81	1.00	.312
172C-8-6	1/2	3/8	11/16-20	1.34	.93	1.10	.406

### Seal Plug 639C

PART NO.	TUBE SIZE	STRAIGHT THREAD	C HEX	L	M
639C-4	1/4	7/16-24	7/16	.74	.50

### Straight Through Tank Fitting 682C

PART NO.	TUBE SIZE	PIPE THREAD	STRAIGHT THREAD	C HEX	L	M	FLOW DIA. D
682C-3-2	3/16	1/8	3/8-24	7/16	1.06	.84	.195
682C-6-6	3/8	3/8	9/16-24	11/16	1.44	1.16	.387
682C-8-8	1/2	1/2	11/16-20	7/8	1.90	1.31	.516

**WARNING** These products can expose you to chemicals including LEAD which is known to the state of California to cause cancer and birth defects or other reproductive harm. For more information go to [www.P65Warnings.ca.gov](http://www.P65Warnings.ca.gov).



- A
- B
- C
- D
- E
- F
- G
- H
- I
- J
- K
- L
- M
- N
- O

A  
B  
C  
D  
E  
F  
G  
H  
I  
J  
K  
L  
M  
N  
O



# Compress-Align® Fittings

Parker's Compress-Align Fittings are pre-assembled with a captive sleeve, always oriented for a faster installation. The design of the captive sleeve aligns to seal even out-of-round tubing.

## Product Features:

- Self-aligning captive sleeve
- 2-piece fitting – Less inventory
- Visible inspection before and after installation
- 1/8" – 1" Sizes
- No flaring, soldering or other tube preparation
- Forged and extruded shapes

## Markets:

- Industrial
- Packaging
- Pneumatic
- Printing
- Chemical

## Applications:

- Air lines
- Lubrication Lines
- Cooling lines
- Industry
- Machinery
- Chemical Dispensing
- Compressors
- Fluid transfer

## Compatible Tubing:

- Copper, Aluminum
- Thermoplastic tubing
- TFE, FEA, PFA

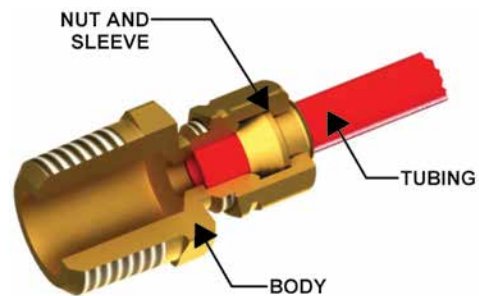

## Assembly Instructions

With nut finger tight on fitting body, insert tubing until it bottoms in the Fitting. Complete the seal with one wrench turn for all sizes.



## Specifications:

**Temperature Range:** -65° to +250° F (-53.8° to +121.1° C)

## Pressure Range:

TUBE SIZE	PSI	bar	TUBE SIZE	PSI	bar
1/8	2800	193.0	1/2	750	51.7
3/16	1900	131.0	5/8	650	44.8
1/4	1400	96.5	3/4	550	37.9
5/16	1200	82.7	7/8	450	31.0
3/8	1000	68.9	1	350	24.1

**WARNING** These products can expose you to chemicals including LEAD which is known to the state of California to cause cancer and birth defects or other reproductive harm. For more information go to [www.P65Warnings.ca.gov](http://www.P65Warnings.ca.gov).

Click here for CADs, Product Specifications or to Configure Parts Online

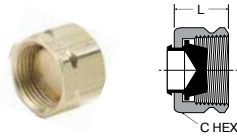

### Plug 59CA

PART NO.	TUBE SIZE	STRAIGHT THREAD	C HEX	L
59CA-4	1/4	7/16-24	1/2	.40
59CA-6	3/8	9/16-24	5/8	.45
59CA-8	1/2	11/16-20	13/16	.50

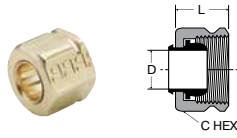

### Nut and Sleeve Assembly 61CA

PART NO.	TUBE SIZE	STRAIGHT THREAD	C HEX	D	L
61CA-2	1/8	5/16-24	3/8	.130	.36
61CA-3	3/16	3/8-24	7/16	.194	.38
61CA-4	1/4	7/16-24	1/2	.255	.40
61CA-5	5/16	1/2-24	9/16	.318	.45
61CA-6	3/8	9/16-24	5/8	.382	.45
61CA-8	1/2	11/16-20	13/16	.507	.50
61CA-10	5/8	13/16-18	15/16	.632	.53
61CA-12	3/4	1-18	1-3/16	.760	.56
61CA-14	7/8	1-1/8-18	1-3/8	.885	.68
61CA-16	1	1-1/4-18	1-1/2	1.012	.63

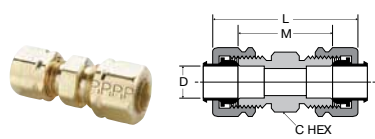

### Union 62CA

PART NO.	SIZE	STRAIGHT THREAD	C HEX	L	M	FLOW DIA. D
62CA-2	1/8	5/16-24	5/16	1.12	.64	.094
62CA-3	3/16	3/8-24	3/8	1.19	.72	.125
62CA-4	1/4	7/16-24	7/16	1.26	.79	.188
62CA-5	5/16	1/2-24	1/2	1.32	.85	.250
62CA-6	3/8	9/16-24	9/16	1.42	.97	.312
62CA-8	1/2	11/16-20	11/16	1.53	1.08	.406
62CA-10	5/8	13/16-18	13/16	1.71	1.23	.500
62CA-12	3/4	1-18	1	2.20	1.41	.562
62CA-14	7/8	1-1/8-18	1-1/8	2.08	1.19	.766

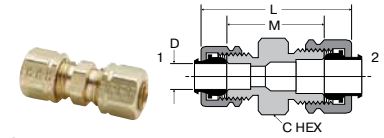

### Union Reducers 62CA

PART NO.	1 TUBE SIZE	2 TUBE SIZE	1 STRAIGHT THREAD	2 STRAIGHT THREAD	C HEX	L	M	FLOW DIA. D
62CA-4-3	3/16	1/4	3/8-24	7/16-24	7/16	1.25	.78	.125
62CA-6-4	1/4	3/8	7/16-24	9/16-24	9/16	1.37	.91	.188
62CA-8-6	3/8	1/2	9/16-24	11/16-20	11/16	1.48	1.03	.312
62CA-10-6	3/8	5/8	9/16-24	13/16-18	13/16	1.59	1.13	.312

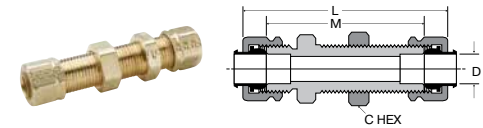

### Bulkhead Union 62CABH

PART NO.	TUBE SIZE	STRAIGHT THREAD	C HEX	L	M	BULKHEAD HOLE DIA.	FLOW DIA. D
62CABH-4	1/4	7/16-24	9/16	2.22	1.75	7/16	.188
62CABH-6	3/8	9/16-24	11/16	2.32	1.88	9/16	.312

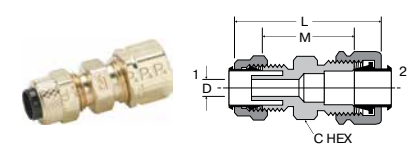

### Union 62PCA

(Poly-Tite to Compress-Align)

PART NO.	TUBE SIZE	1 STRAIGHT THREAD	2 STRAIGHT THREAD	C HEX	L	M	FLOW DIA. D
62PCA-4	1/4	3/8-24	7/16-24	7/16	1.24	.89	.125
62PCA-5	5/16	7/16-24	1/2-24	1/2	1.26	.92	.144
62PCA-6	3/8	1/2-24	9/16-24	9/16	1.32	.98	.204

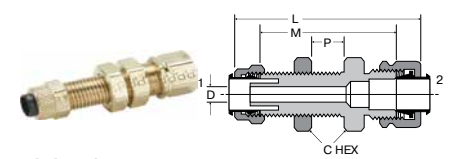

### Bulkhead Union 62PCABH

(Poly-Tite to Compress-Align)

PART NO.	TUBE SIZE	1 STR THD	2 STR THD	C HEX	P MAX	L	M	FLOW BKHD DIA.	FLOW DIA. D
62PCABH-4	1/4	3/8-24	7/16-24	9/16	.38	1.80	1.45	3/8	.125
62PCABH-6	3/8	1/2-24	9/16-24	11/16	.47	1.98	1.64	1/2	.204

**WARNING** These products can expose you to chemicals including LEAD which is known to the state of California to cause cancer and birth defects or other reproductive harm. For more information go to [www.P65Warnings.ca.gov](http://www.P65Warnings.ca.gov).



- A
- B
- C
- D
- E
- F
- G
- H
- I
- J
- K
- L
- M
- N
- O

[Click here for CADs, Product Specifications or to Configure Parts Online](#)

- A
- B
- C
- D
- E
- F
- G
- H
- I
- J
- K
- L
- M
- N
- O

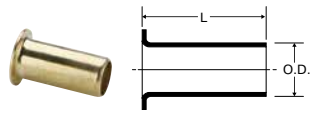

**Brass Insert 63PT**

PART NO.	TUBE SIZE	TUBE WALL	L	O.D.
63PT-2-16	1/8	.016	.46	.080
63PT-2-23	1/8	.023	.45	.073
63PT-3-25	3/16	.025	.45	.135
63PT-3-40	3/16	.040	.52	.095
63NTA-4*	1/4		.53	.163
63PT-4-62	1/4	.062	.33	.110
63PT-5-40	5/16	.040	.50	.232
63PT-5-62	5/16	.062	.53	.187
63NTA-6*	3/8		.64	.245
63NTA-8*	1/2		.81	.370
63PT-10-62	5/8	.062	.72	.483

\* Denotes 304 stainless steel

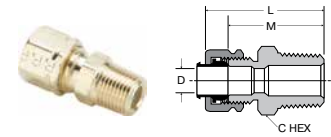

**Male Connector 68CA**

PART NO.	TUBE SIZE	PIPE THREAD	STRAIGHT THREAD	C HEX	L	M	FLOW DIA. D
68CA-2-1	1/8	1/16	5/16-24	3/8	1.02	.78	.095
68CA-2-2	1/8	1/8	5/16-24	7/16	1.01	.77	.094
68CA-3-1	3/16	1/16	3/8-24	3/8	1.07	.84	.125
68CA-3-2	3/16	1/8	3/8-24	7/16	1.07	.84	.125
68CA-3-4	3/16	1/4	3/8-24	9/16	1.26	1.03	.125
68CA-4-2	1/4	1/8	7/16-24	7/16	1.10	.86	.188
68CA-4-4	1/4	1/4	7/16-24	9/16	1.31	1.06	.188
68CA-4-6	1/4	3/8	7/16-24	11/16	1.28	1.03	.188
68CA-4-8	1/4	1/2	7/16-24	7/8	1.56	1.31	.188
68CA-5-2	5/16	1/8	1/2-24	1/2	1.13	.89	.234
68CA-5-4	5/16	1/4	1/2-24	9/16	1.35	1.07	.250
68CA-6-2	3/8	1/8	9/16-24	9/16	1.19	.97	.250
68CA-6-4	3/8	1/4	9/16-24	9/16	1.36	1.14	.312
68CA-6-6	3/8	3/8	9/16-24	11/16	1.43	1.16	.312
68CA-6-8	3/8	1/2	9/16-24	7/8	1.52	1.25	.312
68CA-8-4	1/2	1/4	11/16-20	11/16	1.45	1.22	.312
68CA-8-6	1/2	3/8	11/16-20	11/16	1.43	1.20	.406
68CA-8-8	1/2	1/2	11/16-20	7/8	1.54	1.31	.406
68CA-10-6	5/8	3/8	13/16-18	13/16	1.55	1.31	.406
68CA-10-8	5/8	1/2	13/16-18	7/8	1.72	1.48	.500
68CA-10-12	5/8	3/4	13/16-18	1-1/16	1.80	1.56	.500
68CA-12-8	3/4	1/2	1-18	1	1.99	1.60	.562
68CA-12-12	3/4	3/4	1-18	1-1/16	2.02	1.63	.656
68CA-14-12	7/8	3/4	1-1/8-18	1-1/8	1.85	1.41	.750
68CA-16-12	1	3/4	1-1/4-18	1-1/4	1.83	1.39	.750
68CA-16-16	1	1	1-1/4-18	1-3/8	2.02	1.58	.875

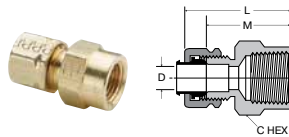

**Female Connector 66CA**

PART NO.	TUBE SIZE	PIPE THREAD	STRAIGHT THREAD	C HEX	L	M	FLOW DIA. D
66CA-2-2	1/8	1/8	5/16-24	9/16	.99	.75	.094
66CA-3-2	3/16	1/8	3/8-24	9/16	1.01	.78	.125
66CA-3-4	3/16	1/4	3/8-24	11/16	1.19	.96	.125
66CA-4-2	1/4	1/8	7/16-24	9/16	1.02	.78	.188
66CA-4-4	1/4	1/4	7/16-24	11/16	1.24	1.00	.188
66CA-5-2	5/16	1/8	1/2-24	9/16	1.05	.81	.250
66CA-5-4	5/16	1/4	1/2-24	11/16	1.27	1.03	.250
66CA-6-2	3/8	1/8	9/16-24	9/16	1.00	.78	.312
66CA-6-4	3/8	1/4	9/16-24	11/16	1.28	1.06	.312
66CA-6-6	3/8	3/8	9/16-24	13/16	1.29	1.06	.312
66CA-6-8	3/8	1/2	9/16-24	1	1.49	1.27	.312
66CA-8-4	1/2	1/4	11/16-20	11/16	1.32	1.09	.406
66CA-8-6	1/2	3/8	11/16-20	13/16	1.35	1.12	.406
66CA-8-8	1/2	1/2	11/16-20	1	1.54	1.31	.406
66CA-10-8	5/8	1/2	13/16-18	1	1.62	1.38	.500

**WARNING** These products can expose you to chemicals including LEAD which is known to the state of California to cause cancer and birth defects or other reproductive harm. For more information go to [www.P65Warnings.ca.gov](http://www.P65Warnings.ca.gov).

Click here for CADs, Product Specifications or to Configure Parts Online

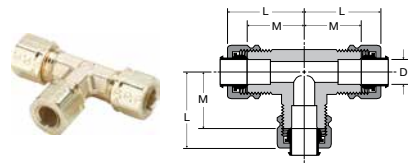

**Union Tee  
164CA-264CA**

PART NO.	TUBE SIZE	STRAIGHT THREAD	L	M	FLOW DIA. D
164CA-2	1/8	5/16-24	.84	.61	.093
264CA-3	3/16	3/8-24	.83	.60	.125
164CA-4	1/4	7/16-24	.84	.63	.188
264CA-4	1/4	7/16-24	.84	.60	.188
164CA-5	5/16	1/2-24	.95	.71	.250
164CA-6	3/8	9/16-24	.96	.74	.312
164CA-8	1/2	11/16-20	1.15	.93	.406
164CA-10	5/8	13/16-18	1.32	1.08	.500
164CA-12	3/4	1.00-18	1.56	1.17	.562

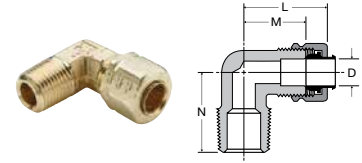

**Male Elbow  
169CA-269CA**

PART NO.	TUBE SIZE	PIPE THREAD	STRAIGHT THREAD	L	M	N	FLOW DIA. D
169CA-2-1	1/8	1/16	5/16-24	.84	.60	.67	.095
269CA-2-2	1/8	1/8	5/16-24	.84	.60	.67	.094
169CA-3-1	3/16	1/16	3/8-24	.84	.61	.67	.126
169CA-3-2	3/16	1/8	3/8-24	.84	.61	.69	.125
269CA-3-2	3/16	1/8	3/8-24	.83	.60	.67	.125
169CA-3-4	3/16	1/4	3/8-24	.87	.64	.93	.125
169CA-4-2	1/4	1/8	7/16-24	.84	.61	.74	.188
269CA-4-2	1/4	1/8	7/16-24	.84	.60	.73	.188
169CA-4-4	1/4	1/4	7/16-24	.86	.62	.94	.188
269CA-4-4	1/4	1/4	7/16-24	.84	.60	.79	.188
169CA-4-6	1/4	3/8	7/16-24	.92	.68	1.00	.188
169CA-5-2 <sup>+</sup>	5/16	1/8	1/2-24	.84	.61	.74	.234
269CA-5-2 <sup>+</sup>	5/16	1/8	1/2-24	.84	.60	.73	.250
169CA-5-4	5/16	1/4	1/2-24	.94	.71	.93	.250
269CA-5-4	5/16	1/4	1/2-24	.91	.67	.82	.250
169CA-5-6	5/16	3/8	1/2-24	.99	.75	1.00	.250
169CA-6-2 <sup>+</sup>	3/8	1/8	9/16-24	.96	.74	.74	.234
269CA-6-2 <sup>+</sup>	3/8	1/8	9/16-24	.96	.69	.75	.220
169CA-6-4	3/8	1/4	9/16-24	.96	.74	.93	.312
269CA-6-4	3/8	1/4	9/16-24	.95	.73	.92	.312
169CA-6-6	3/8	3/8	9/16-24	.97	.75	1.00	.312
269CA-6-6	3/8	3/8	9/16-24	1.06	.84	.97	.312
169CA-6-8	3/8	1/2	9/16-24	1.16	.94	1.27	.312
169CA-8-4 <sup>+</sup>	1/2	1/4	11/16-20	1.17	.94	1.00	.312
169CA-8-6	1/2	3/8	11/16-20	1.15	.93	1.11	.406
169CA-8-8	1/2	1/2	11/16-20	1.23	1.00	1.37	.406
169CA-10-6 <sup>+</sup>	5/8	3/8	13/16-18	1.30	1.06	1.15	.406
169CA-10-8	5/8	1/2	13/16-18	1.30	1.06	1.31	.500
169CA-12-8	3/4	1/2	1-18	1.57	1.18	1.49	.562
169CA-12-12	3/4	3/4	1-18	1.66	1.27	1.58	.562
169CA-16-12 <sup>+</sup>	1	3/4	1-1/4-18	1.63	1.19	1.60	.875

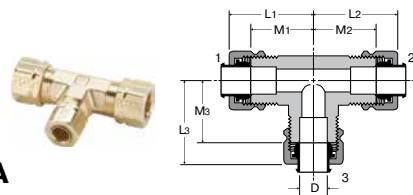

**Union Tee 164CA  
combination sizes**

PART NO.	1 TUBE SIZE	2 TUBE SIZE	3 TUBE SIZE	L1	L2	L3	M1	M2	M3	FLOW DIA. D
164CA-6-4-4	3/8	1/4	1/4	.97	.96	.96	.75	.72	.72	.188
164CA-6-6-4	3/8	3/8	1/4	.97	.97	.96	.75	.75	.72	.188
164CA-8-8-6	1/2	1/2	3/8	1.17	1.17	1.10	.94	.94	.88	.312

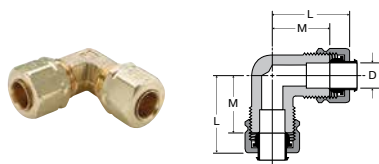

**Union Elbow  
165CA-265CA**

PART NO.	TUBE SIZE	STRAIGHT THREAD	L	M	FLOW DIA. D
165CA-2	1/8	5/16-24	.84	.61	.094
165CA-3	3/16	3/8-24	.84	.61	.125
165CA-4	1/4	7/16-24	.84	.61	.188
265CA-4	1/4	7/16-24	.84	.60	.188
165CA-5	5/16	1/2-24	.94	.71	.250
165CA-6	3/8	9/16-24	.96	.74	.312
165CA-8	1/2	11/16-20	1.15	.93	.406
165CA-10	5/8	13/16-18	1.29	1.05	.500
165CA-12	3/4	1-18	1.56	1.17	.562
165CA-16	1	1-1/4-18	1.63	1.19	.877

<sup>+</sup> For these parts the pipe thread through hole is smaller than the through hole on the tube end.

**WARNING** These products can expose you to chemicals including LEAD which is known to the state of California to cause cancer and birth defects or other reproductive harm. For more information go to [www.P65Warnings.ca.gov](http://www.P65Warnings.ca.gov).

- A
- B
- C
- D
- E
- F
- G
- H
- I
- J
- K
- L
- M
- N
- O

Click here for CADs, Product Specifications or to Configure Parts Online

- A
- B
- C
- D
- E
- F
- G
- H
- I
- J
- K
- L
- M
- N
- O

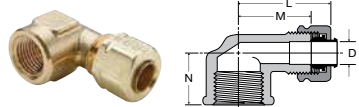

**Female Elbow  
170CA-270CA**

PART NO.	TUBE SIZE	PIPE THREAD	STRAIGHT THREAD	L	M	N	FLOW DIA. D
170CA-2-2	1/8	1/8	5/16-24	.93	.69	.56	.094
170CA-3-2	3/16	1/8	3/8-24	.98	.69	.56	.125
170CA-4-2	1/4	1/8	7/16-24	.98	.69	.56	.188
270CA-4-2	1/4	1/8	7/16-24	.91	.67	.54	.188
170CA-4-4	1/4	1/4	7/16-24	1.02	.78	.67	.188
170CA-6-4	3/8	1/4	9/16-24	1.09	.79	.73	.312
170CA-6-6	3/8	3/8	9/16-24	1.16	.89	.69	.312
170CA-8-6	1/2	3/8	11/16-20	1.23	1.00	.69	.406
170CA-8-8	1/2	1/2	11/16-20	1.38	1.15	.97	.408
170CA-12-12	3/4	3/4	1-18	1.97	1.58	1.58	.563

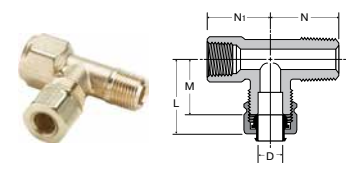

**Adapter Tee 176CA**

PART NO.	TUBE SIZE	PIPE THREAD	STRAIGHT THREAD	L	M	N	N1	FLOW DIA. D
176CA-4-2	1/4	1/8	7/16-24	.92	.69	.75	.66	.188

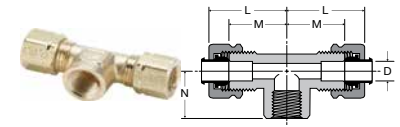

**Female Branch Tee 177CA**

PART NO.	TUBE SIZE	PIPE THREAD	STRAIGHT THREAD	L	M	N	FLOW DIA. D
177CA-4-2	1/4	1/8	7/16-24	.86	.63	.53	.188

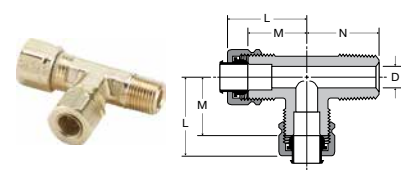

**Male Run Tee 171CA**

PART NO.	TUBE SIZE	PIPE THREAD	STRAIGHT THREAD	L	M	N	FLOW DIA. D
171CA-2-2	1/8	1/8	5/16-24	.84	.61	.67	.094
171CA-3-2	3/16	1/8	3/8-24	.83	.61	.67	.125
171CA-4-2	1/4	1/8	7/16-24	.88	.64	.75	.188
171CA-4-4	1/4	1/4	7/16-24	.93	.69	.92	.188
171CA-6-4	3/8	1/4	9/16-24	1.03	.81	1.03	.312

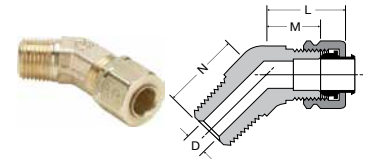

**45° Elbow 179CA**

PART NO.	TUBE SIZE	PIPE THREAD	STRAIGHT THREAD	L	M	N	FLOW DIA. D
179CA-4-2	1/4	1/8	7/16-24	.89	.66	.56	.188
179CA-4-4	1/4	1/4	7/16-24	.80	.56	.84	.188
179CA-6-2	3/8	1/8	9/16-24	.85	.63	.65	.234
179CA-6-4	3/8	1/4	9/16-24	.85	.63	.84	.312
179CA-6-6	3/8	3/8	9/16-24	.97	.75	.95	.312
179CA-8-6	1/2	3/8	11/16-20	1.03	.81	.95	.406

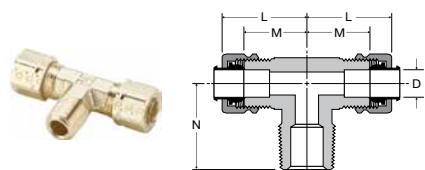

**Male Branch Tee 172CA**

PART NO.	TUBE SIZE	PIPE THREAD	STRAIGHT THREAD	L	M	N	FLOW DIA. D
172CA-2-2	1/8	1/8	5/16-24	.84	.61	.67	.093
172CA-3-2	3/16	1/8	3/8-24	.83	.61	.67	.125
172CA-4-2	1/4	1/8	7/16-24	.84	.61	.74	.188
172CA-4-4	1/4	1/4	7/16-24	.93	.69	.92	.188
172CA-6-2	3/8	1/8	9/16-24	.97	.75	.75	.234
172CA-6-4	3/8	1/4	9/16-24	.99	.77	.92	.312
172CA-6-6	3/8	3/8	9/16-24	1.07	.81	1.00	.312
172CA-8-6	1/2	3/8	11/16-20	1.15	.93	1.10	.406
172CA-12-12	3/4	3/4	1-18	1.67	1.27	1.50	.562

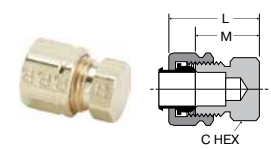

**Seal Plug 639CA**

PART NO.	TUBE SIZE	STRAIGHT THREAD	C HEX	L	M
639CA-4	1/4	7/16-24	7/16	.74	.50

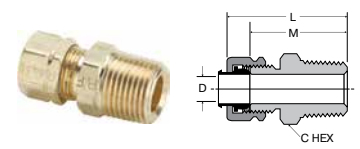

**Straight Through Tank Fitting 682CA**

PART NO.	TUBE SIZE	PIPE THREAD	STRAIGHT THREAD	C HEX	L	M	FLOW DIA. D
682CA-3-2	3/16	1/8	3/8-24	7/16	1.07	.84	.194

**WARNING** These products can expose you to chemicals including LEAD which is known to the state of California to cause cancer and birth defects or other reproductive harm. For more information go to [www.P65Warnings.ca.gov](http://www.P65Warnings.ca.gov).



# Brass Metric Compression Fittings



Parker's Metric Compression Fittings provide users with an economical choice with numerous connection options for a wide variety of tube materials without the need for flaring, soldering or other tube preparation necessary to assemble.

## Product Features:

- 4mm – 28mm tube sizes
- NPT, BSPT, BSPP, Metric Threads
- NBR seal
- Silicone free

## Markets:

- Factory/Process Automation
- Automotive Process
- Packaging
- Pneumatic
- Printing

## Applications:

- Air lines
- Lubrication Lines
- Cooling lines
- Water
- Machinery
- Compressors
- Fluid transfer

## Compatible Tubing:

- Copper
- Aluminum
- Thermoplastic tubing

## Specifications:

**Temperature Range:** -40° to +250° F (-40° to +121.1° C)

## Pressure Range:

TUBE SIZE MM	PSI	bar	TUBE SIZE MM	PSI	bar
4	3335	229.9	14	652	44.9
6	2175	149.9	16	580	39.9
8	1450	99.9	18	536	36.9
10	1087	74.9	20	507	34.9
12	797	54.9	22	435	29.9

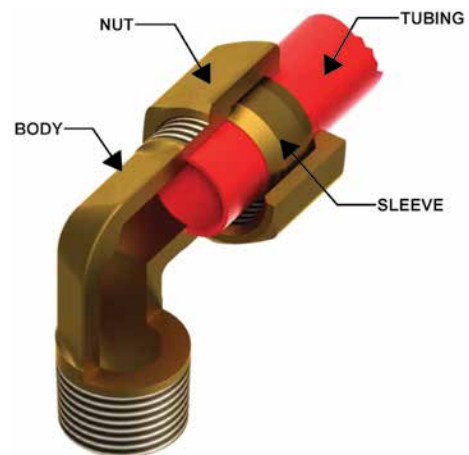

**WARNING** These products can expose you to chemicals including LEAD which is known to the state of California to cause cancer and birth defects or other reproductive harm. For more information go to [www.P65Warnings.ca.gov](http://www.P65Warnings.ca.gov).



[Click here for CADs, Product Specifications or to Configure Parts Online](#)

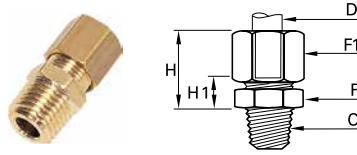

### 0105 Male Connector BSPT

PART NO.	OD	C	F	F1	H MAX	H1	KG
0105 04 10	4	R1/8	10	10	17	7	.012
0105 05 10	5	R1/8	11	12	17.5	7.5	.016
0105 05 13	5	R1/4	14	12	17.5	7.5	.022
0105 06 10	6	R1/8	11	13	18	7.5	.017
0105 06 13	6	R1/4	14	13	18	7.5	.024
0105 06 17	6	R3/8	17	13	18	8.5	.031
0105 08 10	8	R1/8	13	14	19.5	7	.020
0105 08 13	8	R1/4	14	14	19.5	7	.025
0105 08 17	8	R3/8	17	14	20.5	8	.032
0105 10 10	10	R1/8	17	19	24	9	.043
0105 10 13	10	R1/4	17	19	24	9	.047
0105 10 17	10	R3/8	17	19	24	9	.048
0105 10 21	10	R1/2	22	19	25	10	.067
0105 12 13	12	R1/4	19	22	24	9	.059
0105 12 17	12	R3/8	19	22	24	9	.060
0105 12 21	12	R1/2	22	22	25	10	.076
0105 14 13	14	R1/4	22	24	25	8	.068
0105 14 17	14	R3/8	22	24	25	8	.068
0105 14 21	14	R1/2	22	24	26	9	.080
0105 14 27	14	R3/4	27	24	27	10	.107
0105 15 17	15	R3/8	22	24	25	8	.065
0105 15 21	15	R1/2	22	24	26	9	.076
0105 16 13	16	R1/4	24	27	27	9.5	.092
0105 16 17	16	R3/8	24	27	27	9.5	.092
0105 16 21	16	R1/2	24	27	27	9.5	.099
0105 16 27	16	R3/4	27	27	28	10.5	.123
0105 18 21	18	R1/2	27	30	30	10.5	.127
0105 18 27	18	R3/4	27	30	30	10.5	.138
0105 20 21	20	R1/2	30	32	32	11	.148
0105 20 27	20	R3/4	30	32	32	11	.157
0105 22 21	22	R1/2	32	36	33	11	.187
0105 22 27	22	R3/4	32	36	33	11	.196
0105 22 34	22	R1	36	36	33	11	.227
0105 25 27	25	R3/4	36	41	36	11	.261
0105 25 34	25	R1	36	41	36	11	.278
0105 28 27	28	R3/4	41	42	36	11	.274
0105 28 34	28	R1	41	42	36	11	.283

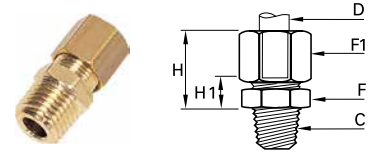

### 0105 Male Connector NPT

PART NO.	OD	C	F	F1	H MAX	H1	KG
0105 06 11	6	NPT1/8	11	13	18	7.5	.018
0105 06 14	6	NPT1/4	14	13	18	7.5	.027
0105 08 11	8	NPT1/8	13	14	21	7	.021
0105 08 14	8	NPT1/4	14	14	18.5	7	.026
0105 10 14	10	NPT1/4	17	19	24	9	.048
0105 10 18	10	NPT3/8	17	19	24	9	.048
0105 10 22	10	NPT1/2	22	19	25	10	.066

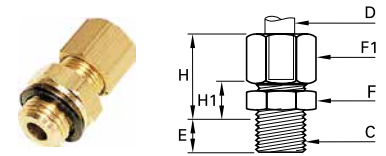

### 0101 Male Connector with Captive Sealing Washer Male BSPP

PART NO.	OD	C	E	F	F1	H MAX	H1	KG
0101 04 19	4	M5X0.8	5	10	10	16.5	8	.011
0101 04 10	4	G1/8	6.5	13	10	16.5	8	.016
0101 05 10	5	G1/8	6.5	13	12	17.5	8.5	.018
0101 06 10	6	G1/8	6.5	13	13	18	8.5	.020
0101 06 13	6	G1/4	8	17	13	18	9.5	.030
0101 08 10	8	G1/8	6.5	13	14	19	8.5	.021
0101 08 13	8	G1/4	8	17	14	19.5	9	.032
0101 08 17	8	G3/8	11	22	14	20	10.5	.044
0101 10 13	10	G1/4	8	17	19	24	11	.049
0101 10 17	10	G3/8	11	22	19	24	11.5	.061
0101 12 13	12	G1/4	8	19	22	24	11	.062
0101 12 17	12	G3/8	11	22	22	24	11.5	.069
0101 12 21	12	G1/2	12	27	22	24	12	.089
0101 14 17	14	G3/8	11	22	24	25	10.5	.074
0101 14 21	14	G1/2	12	27	24	25	11	.094
0101 15 17	15	G3/8	11	22	24	25	10.5	.071
0101 15 21	15	G1/2	12	27	24	25	11	.093
0101 16 17	16	G3/8	11	22	27	27	12	.092
0101 16 21	16	G1/2	12	27	27	27	12.5	.109
0101 18 21	18	G1/2	12	27	30	29.5	12.5	.128
0101 18 27	18	G3/4	13	32	30	29.5	13	.152
0101 20 27	20	G3/4	13	32	32	31	13	.164
0101 22 27	22	G3/4	13	32	36	32	13	.195
0101 22 34	22	G1	15	41	36	31	13.5	.259
0101 25 27	25	G3/4	13	36	41	35.5	13	.261
0101 25 34	25	G1	15	41	41	35.5	13	.169
0101 28 34	28	G1	15	41	42	35.5	13.5	.300

With pre-assembled captive polymer sealing washer

**WARNING** These products can expose you to chemicals including LEAD which is known to the state of California to cause cancer and birth defects or other reproductive harm. For more information go to [www.P65Warnings.ca.gov](http://www.P65Warnings.ca.gov).





[Click here for CADs, Product Specifications or to Configure Parts Online](#)

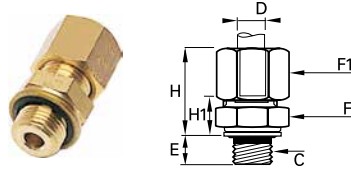

### 0101 Male Connector with Bi-Material Seal Male BSPP

PART NO.	OD	C	E	F	F1	H MAX	H1	KG
0101 04 10 39	4	G1/8	5.5	13	10	17.5	9	.016
0101 05 10 39	5	G1/8	5.5	13	12	18.5	9.5	.019
0101 06 10 39	6	G1/8	5.5	13	13	19	9.5	.020
0101 06 13 39	6	G1/4	7	17	13	19	10.5	.030
0101 08 10 39	8	G1/8	5.5	13	14	20	9.5	.022
0101 08 13 39	8	G1/4	7	17	14	20.5	10	.032
0101 08 17 39	8	G3/8	9.5	22	14	21.5	12	.045
0101 10 13 39	10	G1/4	7	17	19	25	12	.048
0101 10 17 39	10	G3/8	9.5	22	19	25.5	13	.062
0101 12 13 39	12	G1/4	7	19	22	25	12	.063
0101 12 17 39	12	G3/8	9.5	22	22	25	13	.071
0101 12 21 39	12	G1/2	10.5	27	22	25	13.5	.091
0101 14 17 39	14	G3/8	9.5	22	24	26.5	12	.075
0101 14 21 39	14	G1/2	10.5	27	24	26.5	12.5	.095
0101 15 17 39	15	G3/8	9.5	22	24	26.5	12	.073
0101 15 21 39	15	G1/2	10.5	27	24	26.5	12.5	.095
0101 16 17 39	16	G3/8	9.5	22	27	28.5	13.5	.092
0101 16 21 39	16	G1/2	10.5	27	27	28.5	14	.111
0101 18 21 39	18	G1/2	10.5	27	30	31	14	.129
0101 18 27 39	18	G3/4	11.5	32	30	31	14.5	.155
0101 20 27 39	20	G3/4	11.5	32	32	32.5	14.5	.164
0101 22 27 39	22	G3/4	11.5	32	36	32.5	14.5	.197
0101 22 34 39	22	G1	13	41	36	33	15.5	.259
0101 25 34 39	25	G1	13	41	41	37.5	15.5	.309
0101 28 34 39	28	G1	13	41	42	37.5	15.5	.301

Zinc plated steel with NBR seal

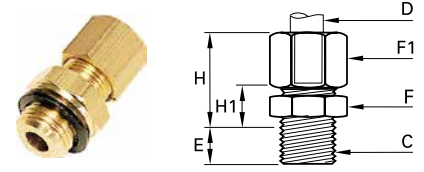

### 0101 Male Connector Metric Thread

PART NO.	OD	C	E	F	F1	H MAX	H1	KG
0101 04 55	4	M7X1	6.5	10	10	16.5	7.5	.012
0101 04 56	4	M8X1	6.5	11	10	16.5	7.5	.013
0101 05 56	5	M8X1	6.5	11	12	17.5	8	.016
0101 05 60	5	M10X1	6.5	14	12	17.5	8.5	.020
0101 06 60	6	M10X1	6.5	14	13	18	8.5	.021
0101 06 62	6	M10X1.5	6.5	14	13	18	8.5	.021
0101 08 65	8	M12X1	8	17	14	19.5	9	.029
0101 08 66	8	M12X1.25	8	17	14	19.5	9	.029
0101 08 68	8	M13X1.25	8	17	14	19.5	9	.030
0101 10 70	10	M14X1.25	8	17	19	24	11	.047
0101 10 71	10	M14X1.5	8	17	19	24	11	.047
0101 10 74	10	M16X1.25	9	19	19	24	11	.051
0101 10 75	10	M16X1.5	9	19	19	24	11	.051
0101 10 78	10	M18X1.5	9	22	19	24	11.5	.060
0101 12 74	12	M16X1.25	9	19	22	24	11	.061
0101 12 75	12	M16X1.5	9	19	22	24	11	.061
0101 12 78	12	M18X1.5	9	22	22	24	11.5	.070
0101 14 78	14	M18X1.5	9	22	24	25	10.5	.077
0101 14 80	14	M20X1.5	10	24	24	25	11	.084
0101 15 78	15	M18X1.5	9	22	24	25	10.5	.071
0101 16 80	16	M20X1.5	10	24	27	27	12.5	.102
0101 16 82	16	M22X1.5	10	27	27	27	12.5	.111
0101 18 82	18	M22X1.5	10	27	30	29.5	12.5	.129
0101 18 83	18	M24X1.5	11	30	30	29.5	13	.142

**WARNING** These products can expose you to chemicals including LEAD which is known to the state of California to cause cancer and birth defects or other reproductive harm. For more information go to [www.P65Warnings.ca.gov](http://www.P65Warnings.ca.gov).



[Click here for CADs, Product Specifications or to Configure Parts Online](#)

- A
- B
- C
- D
- E
- F
- G
- H
- I
- J
- K
- L
- M
- N
- O

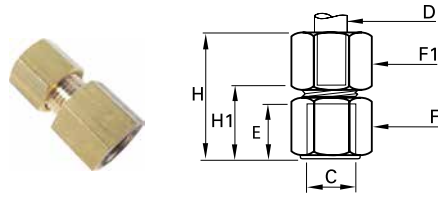

**0114 Female Connector BSPP**

PART NO.	OD	C	E	F	F1	H MAX	H1	KG
0114 04 10	4	G1/8	9.5	14	10	26	16.5	.020
0114 04 13	4	G1/4	13.5	17	10	30	20.5	.030
0114 05 10	5	G1/8	9.5	14	12	28	17	.023
0114 05 13	5	G1/4	13.5	17	12	31	21	.033
0114 06 10	6	G1/8	9.5	14	13	28	17	.025
0114 06 13	6	G1/4	13.5	17	13	32	21	.034
0114 06 17	6	G3/8	14	22	13	32	21.5	.051
0114 08 10	8	G1/8	9.5	14	14	29	16.5	.026
0114 08 13	8	G1/4	13.5	17	14	33	20.5	.036
0114 08 17	8	G3/8	14	22	14	34	21	.052
0114 10 13	10	G1/4	13.5	17	19	37	21.5	.052
0114 10 17	10	G3/8	14	22	19	37	22	.068
0114 10 21	10	G1/2	18.5	27	19	42	26.5	.099
0114 12 13	12	G1/4	13.5	19	22	36	20.5	.069
0114 12 17	12	G3/8	14	22	22	37	22	.078
0114 12 21	12	G1/2	18.5	27	22	42	26.5	.109
0114 14 13	14	G1/4	13.5	22	24	36	18.5	.085
0114 14 17	14	G3/8	14	22	24	38	21	.048
0114 14 21	14	G1/2	18.5	27	24	43	25.5	.113
0114 15 17	15	G3/8	14	22	24	38	21	.078
0114 15 21	15	G1/2	18.5	27	24	43	25.5	.109
0114 16 13	16	G1/4	13.5	24	27	36	18	.107
0114 16 17	16	G3/8	14	24	27	38	20.5	.106
0114 16 21	16	G1/2	18.5	27	27	44	26	.127
0114 18 17	18	G3/8	14	27	30	39	19.5	.140
0114 18 21	18	G1/2	18.5	27	30	45	26	.144
0114 18 27	18	G3/4	19.5	32	30	46	27	.165
0114 20 17	20	G3/8	14	30	32	38	18	.161
0114 20 21	20	G1/2	18.5	30	32	44.5	24	.173
0114 20 27	20	G3/4	19.5	32	32	47	26.5	.170
0114 22 27	22	G3/4	19.5	32	36	48	26.5	.204
0114 25 27	25	G3/4	19.5	36	41	50.5	26	.297

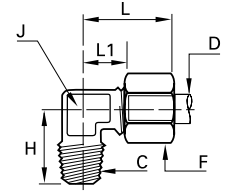

**0109 Male Elbow BSPT**

PART NO.	OD	C	F	H	J	L MAX	L1	KG
0109 04 10	4	R1/8	10	17	8	19	9.5	.016
0109 04 13	4	R1/4	10	20	10	19	11	.026
0109 05 10	5	R1/8	12	17.5	8	21	11	.019
0109 05 13	5	R1/4	12	21.5	10	22	12	.028
0109 06 10	6	R1/8	13	18	8	22	11	.021
0109 06 13	6	R1/4	13	21.5	10	22	12	.031
0109 08 10	8	R1/8	14	18.5	10	28	15	.028
0109 08 13	8	R1/4	14	22	10	28	15	.033
0109 08 17	8	R3/8	14	24	12	28	15	.044
0109 10 13	10	R1/4	19	25	12	30	14.5	.052
0109 10 17	10	R3/8	19	25.5	12	30	14.5	.060
0109 10 21	10	R1/2	19	32	19	36	21	.109
0109 12 13	12	R1/4	22	26	15	30	15	.074
0109 12 17	12	R3/8	22	27	15	30	15	.077
0109 12 21	12	R1/2	22	32	19	36	21	.116
0109 14 17	14	R3/8	24	30	19	35	18	.105
0109 14 21	14	R1/2	24	32	19	35	18	.112
0109 15 17	15	R3/8	24	30	19	35	18	.099
0109 15 21	15	R1/2	24	32	19	35	18	.106
0109 16 17	16	R3/8	27	30	19	39	21	.120
0109 16 21	16	R1/2	27	33.5	19	39	21	.130
0109 16 27	16	R3/4	27	36.5	23	41	23	.189
0109 18 21	18	R1/2	30	35.5	23	41	21.5	.182
0109 18 27	18	R3/4	30	36.5	23	41	21.5	.199
0109 20 21	20	R1/2	32	36.5	23	42	21.5	.181
0109 20 27	20	R3/4	32	38	23	42	21.5	.200
0109 22 27	22	R3/4	36	40	27	50	30	.288
0109 22 34	22	R1	36	44	27	50	30	.342
0109 25 34	25	R1	41	44	27	54	30	.367
0109 28 34	28	R1	42	48	32	54	30	.384

**WARNING** These products can expose you to chemicals including LEAD which is known to the state of California to cause cancer and birth defects or other reproductive harm. For more information go to [www.P65Warnings.ca.gov](http://www.P65Warnings.ca.gov).



[Click here for CADs, Product Specifications or to Configure Parts Online](#)

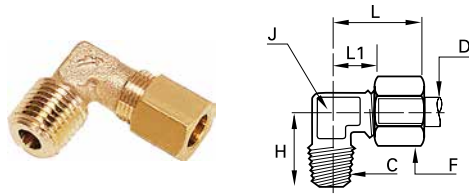

**0109 Male Elbow NPT**

PART NO.	OD	C	F	H	J	L MAX	L1	KG
0109 06 11	6	1/8	13	18	8	22	11	.021
0109 06 14	6	1/4	13	21.5	10	22	12	.030
0109 08 11	8	1/8	14	18.5	10	28	15	.028
0109 08 14	8	1/4	14	22	10	28	15	.033
0109 10 14	10	1/4	19	25	12	30	14.5	.053

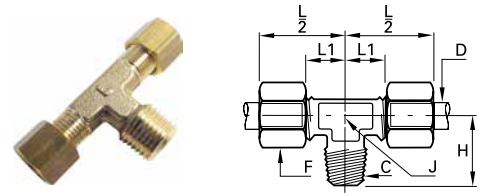

**0108 Male Branch Tee Male BSPT**

PART NO.	OD	C	F	H	J	L1	L2	KG
0108 04 10	4	R1/8	10	17	8	9.5	19	.025
0108 05 10	5	R1/8	12	17.5	8	11	21	.017
0108 06 10	6	R1/8	13	18	8	11	22	.032
0108 06 13	6	R1/4	13	21.5	10	16	27	.047
0108 08 10	8	R1/8	14	18.5	10	15	28	.045
0108 08 13	8	R1/4	14	22	10	15	28	.050
0108 08 17	8	R3/8	14	24	12	15	28	.061
0108 10 13	10	R1/4	19	25	12	14.5	30	.084
0108 10 17	10	R3/8	19	25.5	12	14.5	30	.090
0108 12 13	12	R1/4	22	26	15	15	30	.116
0108 12 17	12	R3/8	22	27	15	15	30	.117
0108 14 17	14	R3/8	24	30	19	18	35	.153
0108 14 21	14	R1/2	24	32	19	18	35	.168
0108 16 17	16	R3/8	27	30	19	21	39	.190
0108 16 21	16	R1/2	27	33.5	19	21	39	.203
0108 18 21	18	R1/2	30	35.5	23	21.5	41	.265
0108 18 27	18	R3/4	30	36.5	23	21.5	41	.292
0108 20 27	20	R3/4	32	38	23	21.5	42	.298
0108 22 27	22	R3/4	36	40	27	29	50	.435
0108 22 34	22	R1	36	44	27	29	50	.466

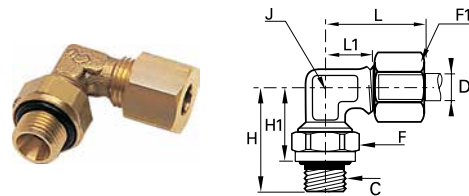

**0199 Adjustable Male Elbow BSPP**

PART NO.	OD	C	F	F1	H	H1	H1 MAX	J	L MAX	L1	KG
0199 04 10	4	G1/8	14	10	23	16	17	8	19	9.5	.023
0199 04 13	4	G1/4	19	10	30.5	22	23.5	10	19	11	.043
0199 06 10	6	G1/8	14	13	23	16	17	8	22	11	.027
0199 06 13	6	G1/4	19	13	30.5	22	23.5	10	22	12	.047
0199 08 10	8	G1/8	14	14	24	17	18	10	28	15	.033
0199 08 13	8	G1/4	19	14	30.5	22	23.5	10	28	15	.051
0199 08 17	8	G3/8	22	14	33.5	24	25.5	12	28	15	.065
0199 10 13	10	G1/4	19	19	31	22.5	24	12	30	14.5	.068
0199 10 17	10	G3/8	22	19	33.5	24	25.5	12	30	14.5	.079
0199 10 21	10	G1/2	27	19	40	29.5	31	19	37	22	.138
0199 14 17	14	G3/8	22	24	35.5	26	27.5	19	35	18	.119
0199 14 21	14	G1/2	27	24	40	29.5	31	19	35	18	.141
0199 18 21	18	G1/2	27	30	40	29	30.5	23	41	21.5	.187
0199 18 27	18	G3/4	32	30	43.5	32	33.5	23	41	21.5	.222
0199 22 27	22	G3/4	32	36	45.5	34	36	32	51	31	.382
0199 22 34	22	G1	41	36	54	40.5	43	32	51	31	.408
0199 28 34	28	G1	41	42	54	40.5	43	32	54	30	.420

The body will orientate for positioning purposes

**WARNING** These products can expose you to chemicals including LEAD which is known to the state of California to cause cancer and birth defects or other reproductive harm. For more information go to [www.P65Warnings.ca.gov](http://www.P65Warnings.ca.gov).



Click here for CADs, Product Specifications or to Configure Parts Online

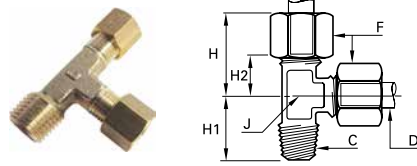

**0103 Male Run Tee BSPT**

PART NO.	OD	C	F	H MAX	H1	H2	J	KG
0103 04 10	4	R1/8	10	19	17	9.5	8	.025
0103 06 10	6	R1/8	13	22	18	11	8	.033
0103 06 13	6	R1/4	13	27	21.5	16	10	.048
0103 08 13	8	R1/4	14	28	22	15	10	.050
0103 08 17	8	R3/8	14	28	24	15	12	.061
0103 10 13	10	R1/4	19	30	25	14.5	12	.084
0103 12 13	12	R1/4	22	30	26	15	15	.114
0103 14 17	14	R3/8	24	35	30	18	19	.161
0103 14 21	14	R1/2	24	35	32	18	19	.169
0103 15 17	15	R3/8	24	35	30	18	19	.148
0103 15 21	15	R1/2	24	35	32	18	19	.158
0103 16 17	16	R3/8	27	39	30	21	19	.192
0103 18 21	18	R1/2	30	41	35.5	21.5	23	.269
0103 18 27	18	R3/4	30	41	36.5	21.5	23	.282
0103 20 27	20	R3/4	32	42	38	21.5	23	.298
0103 22 27	22	R3/4	36	50	40	29	27	.435
0108 22 34	22	R1	36	44	27	29	50	.466

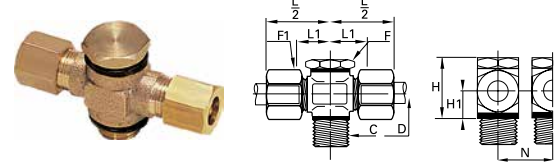

**0119 Double Banjo with Captive Sealing Washer Male BSPP**

PART NO.	OD	C	F	F1	H	H1	L1	L2	N	KG
0119 06 10	6	G1/8	14	13	24	9.5	14.5	25	17.5	.056
0119 08 13	8	G1/4	17	14	25	10	15.5	28	21	.074
0119 08 17	8	G3/8	22	14	32	13	18	30.5	26.5	.140
0119 10 13	10	G1/4	17	19	31	13	19	34	23	.156
0119 10 17	10	G3/8	22	19	32	13	19	34	26.5	.165
0119 12 13	12	G1/4	17	22	34	14.5	19	34	23	.180
0119 12 17	12	G3/8	22	22	35	14.5	19	34	26.5	.182
0119 14 13	14	G1/4	17	24	37	16	20.5	37.5	28	.246
0119 14 17	14	G3/8	22	24	38	16	20.5	37.5	28	.247
0119 14 21	14	G1/2	27	24	40	16	20.5	38	32.5	.219

Zinc plated steel with NBR seal. Thread with pre-assembled polymer washer

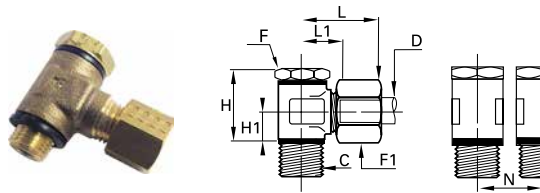

**0118 Single Banjo with Captive Sealing Washer Male BSPP**

PART NO.	OD	C	F	F1	H	H1	L1 MAX	L1	N	KG
0118 05 10	5	G1/8	14	12	24	9.5	25	14.5	17.5	.041
0118 05 13	5	G1/4	17	12	25	10	26	16	21	.058
0118 14 13	14	G1/4	17	24	37	16	37	20.5	28	.154
0118 14 17	14	G3/8	22	24	38	16	37	20.5	28	.195
0118 14 21	14	G1/2	27	24	40	16	38	20.5	32.5	.208
0118 15 17	15	G3/8	22	24	38	16	37	20.5	28	.190
0118 15 21	15	G1/2	27	24	40	16	38	20.5	32.5	.198
0118 16 21	16	G1/2	27	27	42	16	38	21	32.5	.221
0118 18 21	18	G1/2	27	30	46	19.5	43	24.5	36	.366
0118 20 27	20	G3/4	32	32	49	20	44	24.5	39	.403
0118 22 27	22	G3/4	32	36	53	22	45	24.5	39	.459

With pre-assembled captive polymer sealing washer

**WARNING** These products can expose you to chemicals including LEAD which is known to the state of California to cause cancer and birth defects or other reproductive harm. For more information go to [www.P65Warnings.ca.gov](http://www.P65Warnings.ca.gov).

[Click here for CADs, Product Specifications or to Configure Parts Online](#)

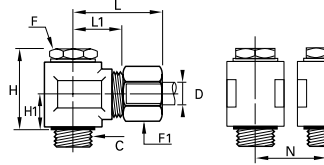

**0118 Single Banjo with Bi-Material Seal Male BSPP**

PART NO.	OD	C	F	F1	H	H1	L1 MAX	L1	N	KG
0118 04 10 39	4	G1/8	14	10	23	9.5	24	14.5	17.5	.038
0118 05 10 39	5	G1/8	14	12	23	9.5	25	14.5	17.5	.041
0118 05 13 39	5	G1/4	17	12	24	10	26	16	21	.064
0118 06 10 39	6	G1/8	14	13	23	9.5	25	14.5	17.5	.042
0118 06 13 39	6	G1/4	17	13	24	10	26	16	21	.057
0118 08 10 39	8	G1/8	14	14	23	9.5	28	15.5	17.5	.055
0118 08 13 39	8	G1/4	17	14	24	10	28	15.5	21	.058
0118 08 17 39	8	G3/8	22	14	31.5	13.5	30	18	26.5	.113
0118 10 13 39	10	G1/4	17	19	30	13	34	19	23	.118
0118 10 17 39	10	G3/8	22	19	31.5	13.5	34	19	26.5	.128
0118 12 13 39	12	G1/4	17	22	33	14.5	34	19	23	.128
0118 12 17 39	12	G3/8	22	22	34.5	15	34	19	26.5	.140
0118 14 13 39	14	G1/4	17	24	36	16	37	20.5	28	.189
0118 14 17 39	14	G3/8	22	24	37.5	16.5	37	20.5	28	.198
0118 14 21 39	14	G1/2	27	24	39	16.5	38	20.5	32.5	.205
0118 15 17 39	15	G3/8	22	24	37.5	16.5	37	20.5	28	.389
0118 15 21 39	15	G1/2	27	24	40	16.5	38	20.5	32.5	.202
0118 16 21 39	16	G1/2	27	27	40	16.5	38	21	32.5	.225
0118 18 21 39	18	G1/2	27	30	47	20	43	24.5	36	.369
0118 20 27 39	20	G3/4	32	32	50	20.5	44	24.5	39	.394
0118 22 27 39	22	G3/4	32	36	54	22.5	45	24.5	39	.462

Zinc plated steel with NBR seal

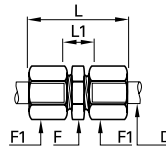

**0106 Equal Tube-to-Tube Connector**

PART NO.	OD	F	F1	L MAX	L1	KG
0106 04 00	4	10	10	28	10	.016
0106 05 00	5	11	12	31	11	.023
0106 06 00	6	11	13	32	11	.026
0106 08 00	8	13	14	36	10	.031
0106 10 00	10	17	19	42	13	.070
0106 12 00	12	19	22	42	13	.092
0106 14 00	14	22	24	45	11	.104
0106 15 00	15	22	24	45	11	.097
0106 16 00	16	24	27	48	13	.141
0106 18 00	18	27	30	53	14	.186
0106 20 00	20	30	32	56	14	.211
0106 22 00	22	32	36	60	14	.283
0106 25 00	25	36	41	64	14	.396
0106 28 00	28	41	42	64	14	.399

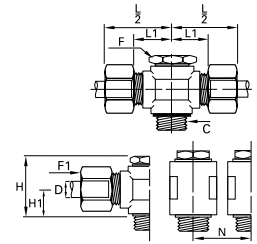

**0119 Double Banjo with Bi-Material Seal Male BSPP**

PART NO.	OD	C	F	F1	H	H1	L1	L2	N	KG
0119 04 10 39	4	G1/8	14	10	23	9.5	14.5	24	17.5	.050
0119 05 10 39	5	G1/8	14	12	23	9.5	14.5	25	17.5	.049
0119 05 13 39	5	G1/4	17	12	24	10	126	26	21	.072
0119 06 10 39	6	G1/8	14	13	23	9.5	14.5	25	17.5	.056
0119 06 13 39	6	G1/4	17	13	24	10	16	26	21	.071
0119 08 10 39	8	G1/8	14	14	23	9.5	15.5	28	17.5	.072
0119 08 13 39	8	G1/4	17	14	24	10	15.5	28	21	.080
0119 08 17 39	8	G3/8	22	14	31.5	13.5	18	30	26.5	.118
0119 10 13 39	10	G1/4	17	19	30	13	19	34	23	.156
0119 10 17 39	10	G3/8	22	19	31.5	13.5	19	34	26.5	.167
0119 12 13 39	12	G1/4	17	22	33	14.5	19	34	23	.180
0119 12 17 39	12	G3/8	22	22	34.5	15	19	34	26.5	.183
0119 14 13 39	14	G1/4	17	24	36	16	20.5	37	28	.248
0119 14 17 39	14	G3/8	22	24	37.5	16.5	20.5	37	28	.247
0119 14 21 39	14	G1/2	27	24	39	16.5	20.5	38	32.5	.262
0119 15 17 39	15	G3/8	22	24	37.5	16.5	20.5	37	28	.246
0119 15 21 39	15	G1/2	27	24	40	16.5	20.5	38	32.5	.251
0119 18 21 39	18	G1/2	27	30	47	20	24.5	43	36	.469
0119 20 27 39	20	G3/4	32	32	50	20.5	24.5	44	39	.638
0119 22 27 39	22	G3/4	32	36	54	22.5	24.5	45	39	.610

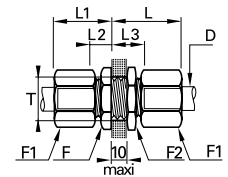

**0116 Bulkhead Union**

PART NO.	OD	F	F1	F2	L MAX	L1 MAX	L2	L3	OT MIN	KG
0116 04 00	4	10	10	13	27	17	7	17	8.3	.024
0116 05 00	5	13	12	14	28	18	7.5	17.5	10.3	.035
0116 06 00	6	13	13	14	28	19	7.5	17.5	10.3	.037
0116 08 00	8	14	14	17	29	20	7	17	12.3	.045
0116 10 00	10	19	19	22	33	25	9	19	16.5	.101
0116 12 00	12	22	22	22	33	25	9	19	18.5	.121
0116 14 00	14	24	24	24	35	25	8	18	20.5	.145
0116 15 00	15	24	24	24	35	25	8	18	20.5	.134
0116 16 00	16	27	27	27	36	28	9.5	19.5	22.5	.189
0116 18 00	18	27	30	30	40	30	10.5	20.5	24.5	.237
0116 20 00	20	32	30	32	41	31	11	21	27.5	.274
0116 22 00	22	36	36	36	42	32	11	21	30.5	.372
0116 25 00	25	36	41	38	46	36	11	21	33.5	.469

**WARNING** These products can expose you to chemicals including LEAD which is known to the state of California to cause cancer and birth defects or other reproductive harm. For more information go to [www.P65Warnings.ca.gov](http://www.P65Warnings.ca.gov).



[Click here for CADs, Product Specifications or to Configure Parts Online](#)

- A
- B
- C
- D
- E
- F
- G
- H
- I
- J
- K
- L
- M
- N
- O

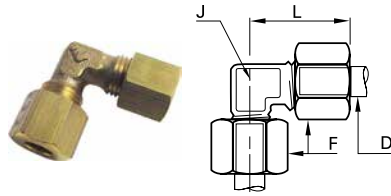

### 0102 Union Elbow

PART NO.	OD	F	J	L MAX	KG
0102 04 00	4	10	5	19	.016
0102 05 00	5	12	8	21	.024
0102 06 00	6	13	8	22	.027
0102 08 00	8	14	10	28	.038
0102 10 00	10	19	12	30	.073
0102 12 00	12	22	15	30	.098
0102 14 00	14	24	19	35	.133
0102 15 00	15	24	19	35	.122
0102 16 00	16	27	19	39	.164
0102 18 00	18	30	23	41	.231
0102 20 00	20	32	23	42	.233
0102 22 00	22	36	27	50	.371
0102 25 00	25	41	27	54	.446
0102 28 00	28	42	32	54.5	.478

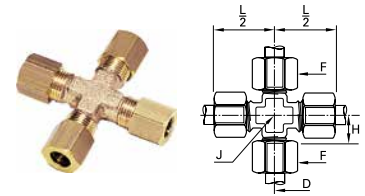

### 0107 Union Cross

PART NO.	OD	F	H	J	L2	KG
0107 04 00	4	10	9.5	8	19	.035
0107 05 00	5	12	11	8	21	.047
0107 08 00	8	14	15	11	28	.073
0107 10 00	10	19	14.5	14	30	.142
0107 12 00	12	22	15	15	35	.096
0107 14 00	14	24	18	20	35	.246
0107 15 00	15	24	18	20	35	.227
0107 16 00	16	27	21	20	39	.312
0107 18 00	18	30	21.5	25	41	.426
0107 20 00	20	32	21.5	25	42	.429
0107 22 00	22	36	29	27	50	.676
0107 25 00	25	41	29	27	50	.819

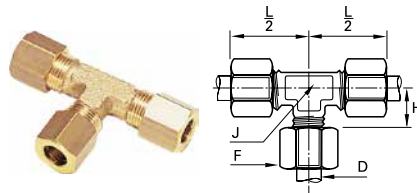

### 0104 Union Tee

PART NO.	OD	F	H	J	L 2	KG
0104 04 00	4	10	9.5	8	19	.028
0104 05 00	5	12	11	8	21	.036
0104 06 00	6	13	11	8	22	.040
0104 08 00	8	14	15	10	28	.055
0104 10 00	10	19	14.5	12	30	.105
0104 12 00	12	22	15	15	30	.142
0104 14 00	14	24	18	19	35	.190
0104 15 00	15	24	18	19	35	.175
0104 16 00	16	27	21	19	39	.239
0104 18 00	18	30	21.5	23	41	.330
0104 20 00	20	32	21.5	23	42	.330
0104 22 00	22	36	29	27	50	.518
0104 25 00	25	41	29	27	54	.630

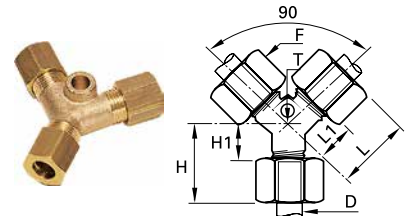

### 0142 Union Y with Mounting Boss

PART NO.	OD	F	H MAX	H1	L MAX	L1	OT	KG
0142 04 00	4	10	16.5	7	26.5	17	4.2	.032
0142 06 00	6	13	19.5	8.5	28	17	4.2	.049
0142 10 00	10	19	24.5	9	37.5	22	6.2	.128
0142 12 00	12	22	26	11	38	23	6.2	.110
0142 14 00	14	24	28	11	41.5	24.5	6.2	.201
0142 15 00	15	24	28	11	41.5	24.5	6.2	.204
0142 16 00	16	27	30	12	43	25	6.2	.252
0142 18 00	18	30	31.5	12	50.5	31	10.2	.220
0142 25 00	25	41	39	14	59	34	10.2	.728

**WARNING** These products can expose you to chemicals including LEAD which is known to the state of California to cause cancer and birth defects or other reproductive harm. For more information go to [www.P65Warnings.ca.gov](http://www.P65Warnings.ca.gov).



[Click here for CADs, Product Specifications or to Configure Parts Online](#)

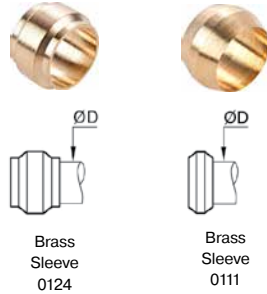

**0124 Suffix 40, 0111 Sleeves**

OD MM	PART NO.	WT	PART NO.	WT
4	0124 04 40	.001	0111 04 00	.001
5	0124 05 40	.001	0111 05 00	.001
6	0124 06 40	.001	0111 06 00	.001
8	0124 08 40	.002	0111 08 00	.002
10	0124 10 40	.003	0111 10 00	.002
12	0124 12 40	.004	0111 12 00	.003
14	0124 14 40	.004	0111 14 00	.003
15	0124 15 40	.004	0111 15 00	.003
16	0124 16 40	.006	0111 16 00	.004
18	0124 18 40	.007	-	-
20	0124 20 40	.009	-	-
22	0124 22 40	.012	-	-
25	0124 25 40	.017	-	-
28	0124 28 40	.017	-	-

**Technical Specifications of Nuts**

**Tightening Torque**

- Maximum kg = tightening torque for nut 0110 and sleeve 0124 on copper, brass or steel tube

OD MM	MAX KG. TORQUE
4	.7
5	.7
6	1.5
8	1.5
10	1.8
12	3
14	3.5
15	4
16	5
18	6
20	6
22	7
25	8
28	9

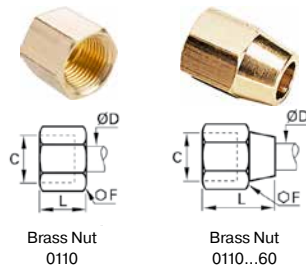

**0110, 0110 Suffix 60 Nuts**

OD MM	C	PART NO.	WT	PART NO.	WT
4	M8X1	0110 04 00	.005	0110 04 00 60	.006
5	M10X1	0110 05 00	.006	0110 05 00 60	.009
6	M10X1	0110 06 00	.008	0110 06 00 60	.011
8	M12X1	0110 08 00	.008	0110 08 00 60	.012
10	M16X1.5	0110 10 00	.019	0110 10 00 60	.027
12	M18X1.5	0110 12 00	.026	0110 12 00 60	.041
14	M20X1.5	0110 14 00	.029	-	-
15	M20X1.5	0110 15 00	.028	0110 15 00 60	.050
16	M22X1.5	0110 16 00	.043	0110 16 00 60	.072
18	M24X1.5	0110 18 00	.059	-	-
20	M27X1.5	0110 20 00	.057	-	-
22	M30X1.5	0110 22 00	.079	-	-
25	M33X1.5	0110 25 00	.121	-	-
28	M36X1.5	0110 28 00	.109	-	-

**WARNING** These products can expose you to chemicals including LEAD which is known to the state of California to cause cancer and birth defects or other reproductive harm. For more information go to [www.P65Warnings.ca.gov](http://www.P65Warnings.ca.gov).



Click here for CADs, Product Specifications or to Configure Parts Online

## Complementary Brass Fittings – Assembly Configuration

The table and information given below illustrate the large number of options available with Parker Legris brass compression fittings. To these must be added the advantages specific to the original Parker Legris reducer shown on the previous page.



0110 BRASS			0110..60 BRASS		0110..40 STEEL	0110..70* POLYMER
	0124 BRASS	0111 BNA** BRAS		0111 BNA** BRAS	01 24...40 STEEL	
No olive required to assemble the plug						No olive required to assemble the tube
Brass plug: 0126	Copper, cold-rolled brass, polymer tube and barb connectors 0122 and 0165	Coiled annealed copper tube	Cold-rolled copper tube for vibration and side loading, etc.	Coiled annealed copper tube for vibration and side loading, etc.	Steel or copper tube: low/medium hydraulic pressure, lubricate before assembly	Polymer tube

### \*Assembly specifications for nut-olive 0110 ..70

This part functions as both olive and nut for flexible polymer tube assemblies:

1. Hand tighten the polymer nut-olive a few turns onto the body of the fitting; the knurling makes this easier.
2. Then introduce the polymer tube and push home into the body of the fitting.
3. Continue manually tightening the polymer nut-olive.
4. Finish tightening using a spanner until the nut body disengages and turns freely, which acts as a torque limiter.

**N.B.:** To avoid damaging the threads, do not insert the tube before hand tightening the nut-olive into the body of the fitting.

\*\*Bureau de Normalisation de l'Automobile (French Automotive Bureau of Standards)

## Recommended Tightening Torque

**Tightening torque in daN.m** = maximum tightening torque of a 0110 nut and 0124 olive with copper, brass or steel tube.

**Nut 0110 and 0110..40**

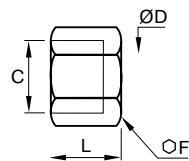

**Nut 0110..60**

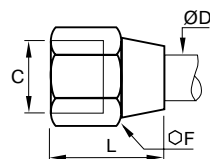

Ø D (MM)	F 0110	F 0110..60	MAX. DAN.M COPPER OR BRASS	F 0110..40	MAX. DAN.M STEEL
4	10	11	.7	10	1.5
5	12	12	.7	12	1.5
6	13	12	1.5	13	2.5
8	14	16	1.5	14	2.5
10	19	20	1.8	19	3
12	22	22	3	22	4.5
14	24	24	3.5	24	5.5
15	24	24	4	24	6
16	27	27	5	27	7
18	30	30	6	30	9
20	32	32	6	32	10
22	36	36	7	36	12
25	41	42	8	41	13
28	42		9		

**WARNING** These products can expose you to chemicals including LEAD which is known to the state of California to cause cancer and birth defects or other reproductive harm. For more information go to [www.P65Warnings.ca.gov](http://www.P65Warnings.ca.gov).



Click here for CADs, Product Specifications or to Configure Parts Online

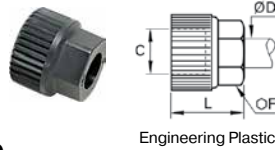

Engineering Plastic

### 0110 Suffix 70 Nut Sleeve

PART NO.	OD MM	C	F MM	L MM	WT
0110 04 00 70	4	M8X1	8	13	.001
0110 06 00 70	6	M10X1	11	15	.002
0110 08 00 70	8	M12X1	13	16	.002
0110 10 00 70	10	M16X1.5	17	19	.004
0110 12 00 70	12	M18X1.5	19	19	.005
0110 14 00 70	14	M20X1.5	22	20	.007
0110 16 00 70	16	M22X1.5	24	21	.009

Plastic nut-sleeve should not be used on metal tubes.

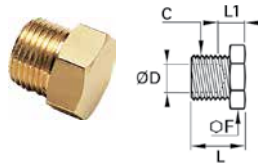

### 0125 End Plug Metric

PART NO.	OD MM	C	F MM	L MM	L1 MM	WT
0125 06 00	6	M10X1	11	13.5	9.5	.009
0125 08 00	8	M12X1	14	14	9	.012
0125 10 00	10	M16X1.5	17	18	11	.025

The plug enables unused tubes to be blanked off. The male thread on the plug has the same pitch as the female thread on the nut of a standard Legris fitting. Therefore, the plug screwed into the nut blanks off the tube.

To reopen the passage, simply unscrew the plug and fit the required connector. No further treatment of the tube is required.

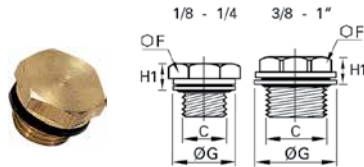

Brass with Bi-Material Seal

### 0220 Male Plug BSPP

PART NUMBER	C BSPP	F MM	G MM	H1 MM	WT
0220 10 00 39	G 1/8	14	14	6.5	.005
0220 13 00 39	G 1/4	17	17	6.5	.016
0220 17 00 39	G 3/8	17	22	8	.021
0220 21 00 39	G 1/2	22	26	9	.045
0220 27 00 39	G 3/4	22	32	10	.053
0220 34 00 39	G 1	27	39.5	10.5	.067

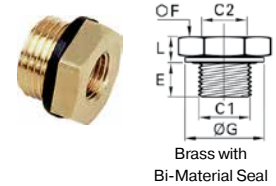

Brass with Bi-Material Seal

### 0168 Reducer Male To Female BSPP

PART NO.	C1 BSPP	C2 BSPP	E MM	F MM	G MM	L MM	WT
0168 10 19 39	G 1/8	M5X.8	8	14	14	4.5	.010
0168 13 19 39	G 1/4	M5X.8	8	17	17	5	.012
0168 13 10 39	G 1/4	G 1/8	8	17	17	5	.020
0168 17 10 39	G 3/8	G 1/8	10	19	22	5	.028
0168 17 13 39	G 3/8	G 1/4	10	19	22	5	.035
0168 21 10 39	G 1/2	G 1/8	12	24	26	7.5	.039
0168 21 13 39	G 1/2	G 1/4	12	24	26	7.5	.056
0168 21 17 39	G 1/2	G 3/8	12	24	26	7.5	.062
0168 27 13 39	G 3/4	G 1/4	12	32	32	9.5	.067
0168 27 17 39	G 3/4	G 3/8	12	32	32	9.5	.097
0168 27 21 39	G 3/4	G 1/2	12	32	32	9.5	.116



### 0127 Tube Support for Plastic Tube

PART NO.	ØD1 MM	ØD2 MM	WT
0127 04 00	4	2	.001
0127 04 27	4	2.7	.001
0127 05 03	5	3	.001
0127 05 00	5	3.3	.001
0127 06 00	6	4	.001
0127 08 55	8	5.5	.001
0127 08 00	8	6	.001
0127 10 07	10	7	.002
0127 10 75	10	7.5	.002
0127 10 00	10	8	.002
0127 12 08	12	8	.002
0127 12 09	12	9	.002
0127 12 00	12	10	.002
0127 14 11	14	11	.003
0127 14 00	14	12	.003
0127 15 12	15	12	.003
0127 16 13	16	13	.003
0127 18 14	18	14	.004
0127 20 15	20	15	.004
0127 22 16	22	16	.005
0127 25 19	25	19	.005

At high temperature and pressure or during oscillating movements, the use of tube supports prevents distortion of the tube and guarantees effective gripping and sealing.

**WARNING** These products can expose you to chemicals including LEAD which is known to the state of California to cause cancer and birth defects or other reproductive harm. For more information go to [www.P65Warnings.ca.gov](http://www.P65Warnings.ca.gov).



A  
B  
C  
D  
E  
F  
G  
H  
I  
J  
K  
L  
M  
N  
O



# Poly-Tite Fittings

Parker's Poly-Tite Fittings are compact, pre-assembled compression style fittings designed for fast assembly. An exclusive acetal copolymer sleeve has superior resilience to resist creeping and stress caused from compression.

## Product Features:

- Self aligning captive sleeve
- Built-in tube support
- Knurled nuts for hand tightening
- Plastic and brass sleeves available
- Chrome plated and stainless steel side latch couplers available

## Markets:

- Dental
- Packaging
- Machine Tools
- Car Wash
- Printing

## Applications:

- Pneumatic Systems
- Water Lines
- Dental Equipment

## Specifications:

<b>Pressure Range</b>	Up to 150 PSI (10.3 bar)
<b>Temperature Range</b>	0° to +150° F (-17.7° to +65.5° C)
<b>O-rings</b>	Buna N on chrome plated couplers Fluorocarbon on Stainless Steel couplers

## Compatible Tubing:

- Polyethylene
- Nylon
- Polypropylene
- Vinyl

## Assembly Instructions

Polyethylene, polypropylene and vinyl tubing:

1. Cut tubing squarely—maximum of 15° angle allowable.
2. Check that port or mating part is clean and free of debris.
3. Insert tube end until it bottoms in the Poly-Tite fitting and tighten knurl/hex nut finger-tight — plus one wrench turn.

## Tube Support O.D.

TUBE SIZE INCHES	* D1 TUBE SUPPORT O.D.
1/4	.168
5/16	.185
3/8	.248
1/2	.373

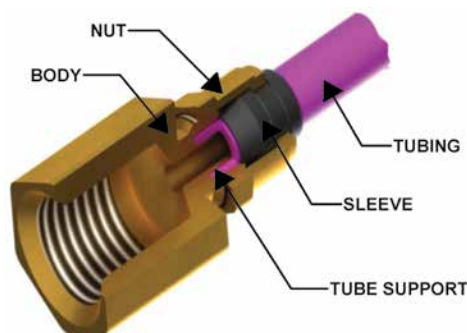
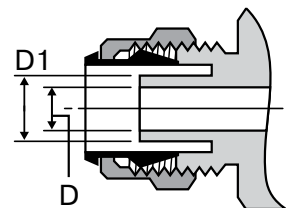

**WARNING** These products can expose you to chemicals including NICKEL or LEAD, which are known to the state of California to cause cancer, and LEAD which is known to cause birth defects or other reproductive harm. For more information go to [www.P65Warnings.ca.gov](http://www.P65Warnings.ca.gov).



Click here for CADs, Product Specifications or to Configure Parts Online

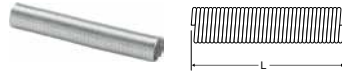

### Spring Guard 56PSG

PART NO.	TUBE O.D.	L
56PSG-4	1/4	3.000
56PSG-6	3/8	3.000

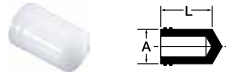

### Plastic Cap 59P

PART NO.	TUBE SIZE	A	L
59P-4	1/4	.247	.50
59P-6	3/8	.372	.56

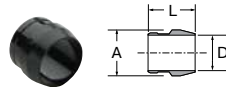

### Acetal Plastic Sleeve 60P

PART NO.	TUBE SIZE	A	D	L
60P-4	1/4	.334	.261	.338
60P-5	5/16	.405	.321	.340
60P-6	3/8	.465	.381	.367
60P-8	1/2	.628	.514	.399

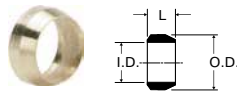

### Sleeve 60PB

PART NO.	L	O.D.	I.D.
60PB-4	.187	.336	.255
60PB-5	.187	.400	.318
60PB-6	.218	.460	.382
60PB-8	.250	.620	.507

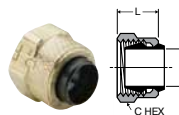

### Nut and Plastic Sleeve Assembly 61P

PART NO.	TUBE SIZE	STRAIGHT THREAD	C HEX	D	L
61P-4	1/4	3/8-24	7/16	.261	.38
61P-5	5/16	7/16-24	1/2	.321	.34
61P-6	3/8	1/2-24	9/16	.380	.38
61P-8	1/2	11/16-20	3/4	.514	.44

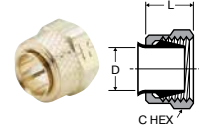

### Nut and Brass Sleeve Assembly 61PB

PART NO.	TUBE SIZE	STRAIGHT THREAD	C HEX	D	L
61PB-4	1/4	3/8-24	7/16	.255	.38
61PB-5	5/16	7/16-24	1/2	.318	.34
61PB-6	3/8	1/2-24	9/16	.382	.38
61PB-8	1/2	11/16-20	3/4	.507	.44

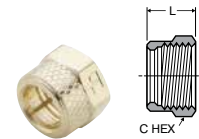

### Nut 61PN

PART NO.	TUBE SIZE	STRAIGHT THREAD	C HEX	L
61PN-4	1/4	3/8-24	7/16	.38
61PN-5	5/16	7/16-24	1/2	.34
61PN-6	3/8	1/2-24	9/16	.38
61PN-8	1/2	11/16-20	3/4	.44



### Nut only for use with Spring Gaurd 61PSGN

PART NO.	TUBE O.D.	L	C HEX
61PSGN-4	1/4	.625	.437
61PSGN-6	3/8	.656	.562

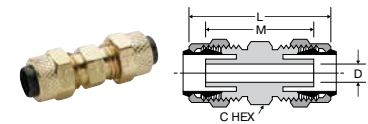

### Union 62P

PART NO.	TUBE SIZE	STRAIGHT THREAD	C HEX	L	M	FLOW DIA. D
62P-4	1/4	3/8-24	3/8	1.17	.96	.125
62P-5	5/16	7/16-24	7/16	1.16	.96	.144
62P-6	3/8	1/2-24	1/2	1.23	.99	.204
62P-8	1/2	11/16-20	11/16	1.47	1.24	.323

**WARNING** These products can expose you to chemicals including NICKEL or LEAD, which are known to the state of California to cause cancer, and LEAD which is known to cause birth defects or other reproductive harm. For more information go to [www.P65Warnings.ca.gov](http://www.P65Warnings.ca.gov).



- A
- B
- C
- D
- E
- F
- G
- H
- I
- J
- K
- L
- M
- N
- O

Click here for CADs, Product Specifications or to Configure Parts Online

- A
- B
- C
- D
- E
- F
- G
- H
- I
- J
- K
- L
- M
- N
- O

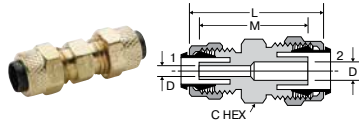

### Union Reducer 62P

PART NO.	1 TUBE SIZE	2 TUBE SIZE	1 STRAIGHT THREAD	2 STRAIGHT THREAD	C HEX	L	M	FLOW DIA. D
62P-6-4	1/4	3/8	3/8-24	1/2-24	1/2	1.22	.99	.125

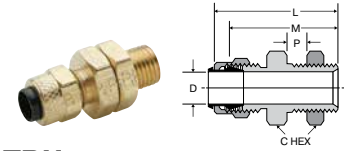

### Bulkhead Union 62PTBH

(Straight Through)

PART NO.	TUBE SIZE	STRAIGHT THREAD	C HEX	P MAX.	L	M	BULKHEAD HOLE DIA.	FLOW DIA. D
62PTBH-4	1/4	3/8-24	9/16	.31	1.19	.93	3/8	.260
62PTBH-5	5/16	7/16-24	5/8	.31	1.19	.93	7/16	.323
62PTBH-6	3/8	1/2-24	11/16	.34	1.26	.99	1/2	.387

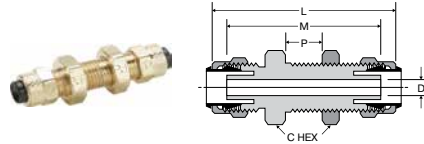

### Bulkhead Union 62PBH

PART NO.	TUBE SIZE	STRAIGHT THREAD	C HEX	P MAX.	L	M	BULKHEAD HOLE DIA.	FLOW DIA. D
62PBH-4	1/4	3/8-24	9/16	.38	1.75	1.53	3/8	.125
62PBH-5	5/16	7/16-24	5/8	.38	1.71	1.52	7/16	.144
62PBH-6	3/8	1/2-24	11/16	.47	1.89	1.65	1/2	.204
62PBH-8	1/2	11/16-20	7/8	.63	2.28	2.05	11/16	.323

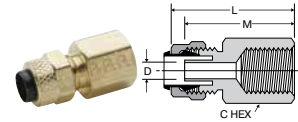

### Female Connector 66P

PART NO.	TUBE SIZE	PIPE THREAD	STRAIGHT THREAD	C HEX	L	M	FLOW DIA. D
66P-4-2	1/4	1/8	3/8-24	9/16	.97	.86	.125
66P-4-4	1/4	1/4	3/8-24	5/8	1.18	1.07	.125
66P-5-2	5/16	1/8	7/16-24	9/16	.97	.86	.144
66P-6-4	3/8	1/4	1/2-24	5/8	1.18	1.07	.204
66P-8-6	1/2	3/8	11/16-20	13/16	1.31	1.20	.323

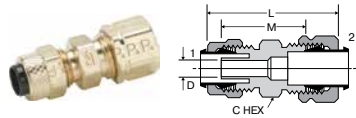

### Union 62PCA

(Tube to Compress-Align)

PART NO.	TUBE SIZE	1 STRAIGHT THREAD	2 STRAIGHT THREAD	C HEX	L	M	FLOW DIA. D
62PCA-4	1/4	3/8-24	7/16-24	7/16	1.25	.89	.125
62PCA-5	5/16	7/16-24	1/2-24	1/2	1.30	.92	.144
62PCA-6	3/8	1/2-24	9/16-24	9/16	1.37	.98	.204

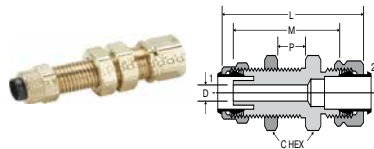

### Bulkhead Union 62PCABH

(Tube to Compress-Align)

PART NO.	TUBE SIZE	1 STR THD	2 STR THD	C HEX	P MAX	L	M	BLKHD HOLE DIA.	FLOW DIA. D
62PCABH-4	1/4	3/8-24	7/16-24	9/16	.38	1.81	1.45	3/8	.125
62PCABH-6	3/8	1/2-24	9/16-24	11/16	.47	2.03	1.64	1/2	.204

**WARNING** These products can expose you to chemicals including NICKEL or LEAD, which are known to the state of California to cause cancer, and LEAD which is known to cause birth defects or other reproductive harm. For more information go to [www.P65Warnings.ca.gov](http://www.P65Warnings.ca.gov).



[Click here for CADs, Product Specifications or to Configure Parts Online](#)

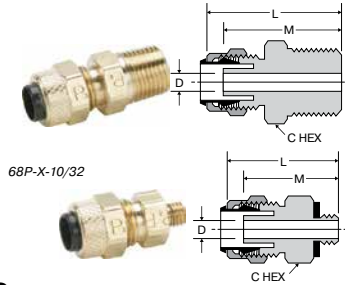

### Male Connector 68P

PART NO.	TUBE SIZE	PIPE THREAD	STRAIGHT THREAD	C HEX	L	M	FLOW DIA. D
68P-4-1	1/4	1/16	3/8-24	3/8	1.06	.95	.125
68P-4-10X32	1/4	10-32	3/8-24	3/8	.86	.75	.094
68P-4-2	1/4	1/8	3/8-24	7/16	1.06	.95	.125
68P-4-4	1/4	1/4	3/8-24	9/16	1.25	1.14	.125
68P-4-6	1/4	3/8	3/8-24	11/16	1.28	1.17	.125
68P-5-2	5/16	1/8	7/16-24	7/16	1.05	.95	.144
68P-5-4	5/16	1/4	7/16-24	9/16	1.24	1.14	.144
68P-6-2	3/8	1/8	1/2-24	1/2	1.10	.98	.204
68P-6-4	3/8	1/4	1/2-24	9/16	1.29	1.17	.204
68P-6-6	3/8	3/8	1/2-24	11/16	1.29	1.17	.204
68P-8-4	1/2	1/4	11/16-20	11/16	1.46	1.29	.320
68P-8-6	1/2	3/8	11/16-20	11/16	1.37	1.29	.323

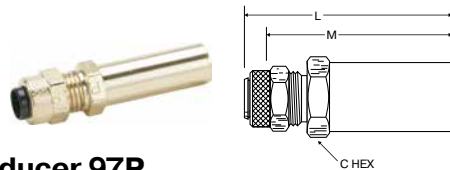

### Tube End Reducer 97P

PART NO.	TUBE O.D.	L	M	C HEX
97P-4-6	3/8 X 1/4	1.718	1.625	.437
97P-6-8	1/2 X 3/8	1.875	1.781	.562

### Pipe Coupler Body 391P

(Chrome Plated)

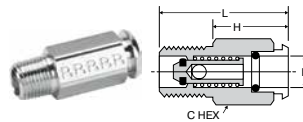

PART NO.	D-INSERT DIA.	PIPE THREAD	C HEX	H	L
391P-4-2	1/4	1/8	1/2	.91	1.29
391P-4-4	1/4	1/4	9/16	.73	1.29
391P-6-4	3/8	1/4	11/16	.85	1.41

### Pipe Coupler Body 391PSS

(Stainless Steel)

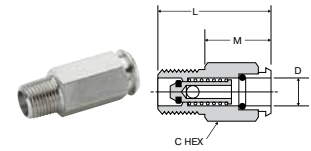

PART NO.	D INSERT DIA.	PIPE THREAD	L	C HEX	M
391PSS-4-2	1/4	1/8	1.271	.500	.900
391PSS-4-4	1/4	1/4	1.271	.562	.710
391PSS-6-4	3/8	1/4	1.40	.625	.840

### Bulkhead Coupler Body 392P

(Chrome Plated)

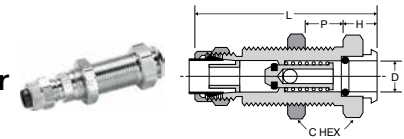

PART NO.	TUBE SIZE	D-INSERT DIA.	STRAIGHT THREAD	C HEX	P MAX.	H	L	BULKHEAD HOLE DIA.
392P-4-4	1/4	1/4	1/2-24	5/8	.84	.39	2.13	1/2
392P-6-6	3/8	3/8	11/16-24	13/16	.93	.37	2.01	11/16

### Bulkhead Coupler Body 392PSS

(Stainless Steel)

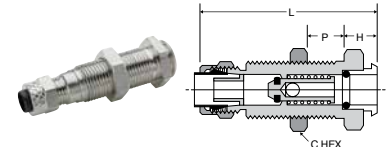

PART NO.	TUBE O.D.	BULKHEAD THREAD	L	C HEX	H	P MAX	BULKHEAD HOLE DIA.
392PSS-4-4	1/4	1/2-24	2.03	.625	.28	.84	1/2
392PSS-6-6	3/8	11/16-24	2.20	.812	.31	.93	11/16

### Through Type Insert 393P

(Chrome Plated)

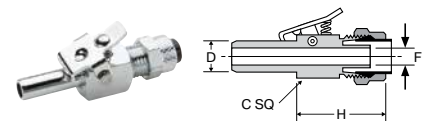

PART NO.	TUBE SIZE	D-INSERT DIA.	STRAIGHT THREAD	C SQUARE	H	FLOW DIA. F
393P-4-4	1/4	1/4	3/8-24	7/16	1.12	.125
393P-6-6	3/8	3/8	1/2-24	1/2	1.34	.203

### Through Type Insert 393PSS

(Stainless Steel)

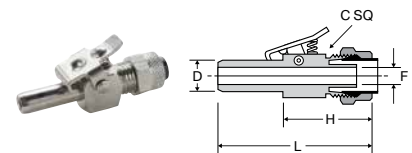

PART NO.	TUBE O.D.	D-INSERT DIA.	L	C SQUARE	H	FLOW DIA. F
393PSS-4-4	1/4	1/4	1.677	7/16	.99	.125
393PSS-6-6	3/8	3/8	2.030	1/2	1.27	.203

**WARNING** These products can expose you to chemicals including NICKEL or LEAD, which are known to the state of California to cause cancer, and LEAD which is known to cause birth defects or other reproductive harm. For more information go to [www.P65Warnings.ca.gov](http://www.P65Warnings.ca.gov).



- A
- B
- C
- D
- E
- F
- G
- H
- I
- J
- K
- L
- M
- N
- O

Click here for CADs, Product Specifications or to Configure Parts Online

- A
- B
- C
- D
- E
- F
- G
- H
- I
- J
- K
- L
- M
- N
- O

### Shutoff Type Insert 393PD

(Chrome Plated)

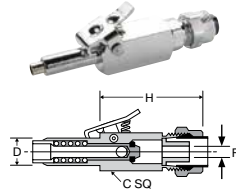

PART NO.	TUBE SIZE	D-INSERT DIA.	STRAIGHT THREAD	C SQUARE	H	FLOW DIA. F
393PD-4-4	1/4	1/4	3/8-24	7/16	1.61	.110
393PD-6-6	3/8	3/8	1/2-24	1/2	1.45	.187

### Double End Shutoff Bulkhead Quick Coupler 394PD

(Chrome Plated)

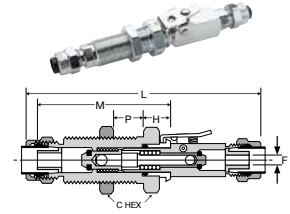

PART NO.	TUBE SIZE	STRAIGHT THREAD	C HEX	P MAX	H	L	M	BULKHEAD HOLE DIA.	FLOW DIA. F
394PD-4-4	1/4	1/2-24	5/8	.84	.39	3.77	2.13	1/2	.125
394PD-6-6	3/8	11/16-24	13/16	.93	.37	3.48	2.01	11/16	.204

### Shut-Off Type Insert 393PDSS

(Stainless Steel)

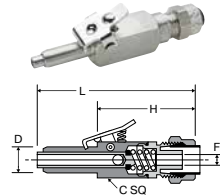

PART NO.	TUBE O.D.	D-INSERT DIA.	L	C SQUARE	H	FLOW DIA. F
393PDSS-4-4	1/4	1/4	2.46	.500	1.62	.116
393PDSS-6-6	3/8	3/8	2.60	.500	1.67	.157

### Double End Shut-Off Bulkhead Quick Coupler 394PDSS

(Stainless Steel)

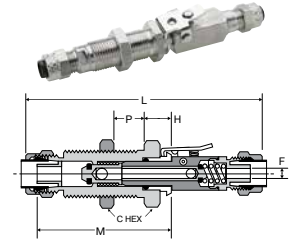

PART NO.	TUBE O.D.	BULKHEAD THREAD	L	M	C HEX	H	P MAX	FLOW DIA. F
394PDSS-4-4	1/4	1/2-24	3.69	2.67	.625	.32	.84	.125
394PDSS-6-6	3/8	11/16-24	3.91	2.24	.812	.34	.93	.203

### Single End Shutoff Bulkhead Quick Coupler 394P

(Chrome Plated)

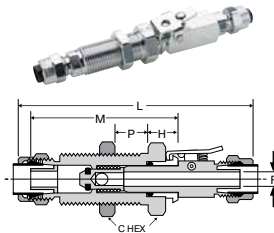

PART NO.	TUBE SIZE	STRAIGHT THREAD	C HEX	P MAX	H	L	M	BULKHEAD HOLE DIA.	FLOW DIA. F
394P-4-4	1/4	1/2-24	5/8	.84	.39	3.28	2.13	1/2	.125
394P-6-6	3/8	11/16-24	13/16	.93	.37	3.41	2.01	11/16	.203

### Single End Shutoff Pipe Connector Quick Coupler 398P

(Chrome Plated)

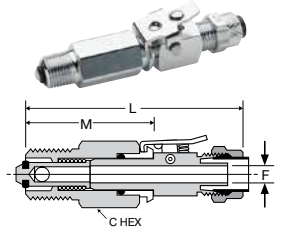

PART NO.	TUBE SIZE	PIPE THREAD	STRAIGHT THREAD	C HEX	L	M	FLOW DIA. F
398P-4-2	1/4	1/8	3/8-24	1/2	2.45	1.32	.125
398P-4-4	1/4	1/4	3/8-24	9/16	2.45	1.32	.125
398P-6-4	3/8	1/4	1/2-24	5/8	2.80	1.46	.203

### Coupler Single End Shut-Off Bulkhead 394PSS

(Stainless Steel)

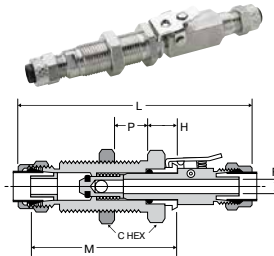

PART NO.	TUBE O.D.	BULKHEAD THREAD	L	M	C HEX	H	P MAX	FLOW DIA. F
394PSS-4-4	1/4	1/2-24	3.05	2.06	.625	.31	.84	.125
394PSS-6-6	3/8	11/16-24	3.50	2.23	.812	.34	.93	.203

### Single End Shut-Off Connector Quick Coupler 398PSS

(Stainless Steel)

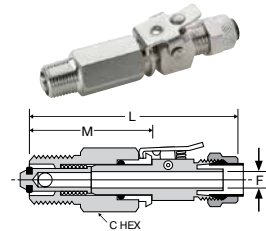

PART NO.	TUBE O.D.	PIPE THREAD	L	M	C HEX	FLOW DIA. F
398PSS-4-2	1/4	1/8	2.30	1.32	.500	.125
398PSS-4-4	1/4	1/4	2.30	1.32	.562	.125
398PSS-6-4	3/8	1/4	2.70	1.43	.625	.203

**WARNING** These products can expose you to chemicals including NICKEL or LEAD, which are known to the state of California to cause cancer, and LEAD which is known to cause birth defects or other reproductive harm. For more information go to [www.P65Warnings.ca.gov](http://www.P65Warnings.ca.gov).



Click here for CADs, Product Specifications or to Configure Parts Online

### Double End Shutoff Pipe Connector Quick Coupler 398PD

(Chrome Plated)

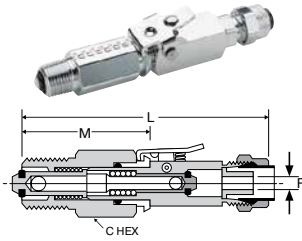

PART NO.	TUBE SIZE	PIPE THREAD	STRAIGHT THREAD	C HEX	L	M	FLOW DIA. F
398PD-4-2	1/4	1/8	3/8-24	1/2	2.93	1.31	.125
398PD-4-4	1/4	1/4	3/8-24	9/16	2.93	1.32	.125
398PD-6-4	3/8	1/4	1/2-24	5/8	2.88	1.43	.204

### Double End Shut-Off Pipe Connector Quick Coupler 398PDSS

(Stainless Steel)

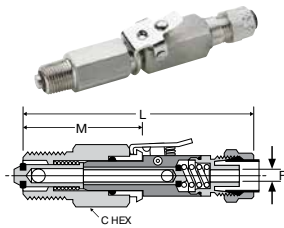

PART NO.	TUBE O.D.	PIPE THREAD	L	M	C HEX	FLOW DIA. D
398PDSS-4-2	1/4	1/8	2.93	1.31	.500	.125
398PDSS-4-4	1/4	1/4	2.93	1.31	.562	.125
398PDSS-6-4	3/8	1/4	3.10	1.43	.625	.125

### Union Tee 164P

PART NO.	TUBE SIZE	STRAIGHT THREAD	L	M	FLOW DIA. D
164P-4	1/4	3/8-24	.84	.73	.125
164P-5	5/16	7/16-24	.83	.73	.144
164P-6	3/8	1/2-24	.98	.86	.203
164P-8	1/2	11/16-20	1.12	1.04	.323

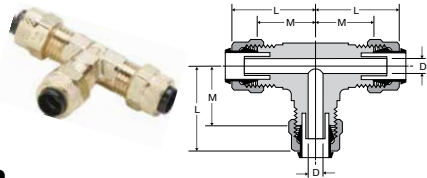

### Union Tee 164P combination size

PART NO.	1 TUBE SIZE	2 TUBE SIZE	3 TUBE SIZE	L	L1	M	M1	FLOW DIA. D
164P-6-4	3/8	3/8	1/4	.98	.90	.86	.79	.125

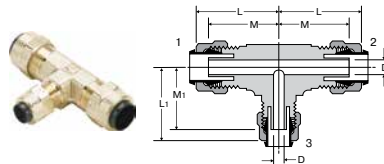

### Male Elbow 169P

PART NO.	TUBE SIZE	PIPE THREAD	STRAIGHT THREAD	L	M	N	FLOW DIA. D
169P-4-1	1/4	1/16	3/8-24	.92	.58	.67	.130
169P-4-2	1/4	1/8	3/8-24	.84	.73	.75	.121
169P-4-4	1/4	1/4	3/8-24	.90	.79	.92	.125
169P-4-6	1/4	3/8	3/8-24	.93	.84	1.08	.125
169P-5-2	5/16	1/8	7/16-24	.87	.73	.68	.144
169P-6-2	3/8	1/8	1/2-24	.93	.81	.73	.203
169P-6-4	3/8	1/4	1/2-24	.98	.86	1.05	.203
169P-6-6	3/8	3/8	1/2-24	.98	.86	1.08	.203
169P-8-6	1/2	3/8	11/16-20	1.12	1.04	1.13	.323

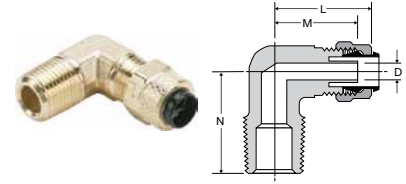

### Long Male Elbow 169LP

PART NO.	TUBE SIZE	PIPE THREAD	STRAIGHT THREAD	L	M	N	FLOW DIA. D
169LP-4-4	1/4	1/4	3/8-24	.90	.79	1.38	.125

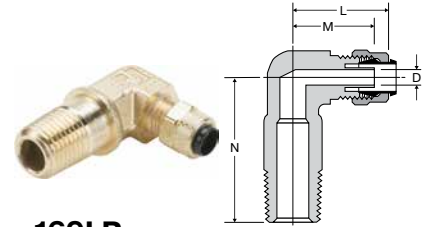

### Male Elbow Swivel 169PS

PART NO.	TUBE O.D.	PIPE THREAD	A	B	C HEX	D	E
169PS-4-2	1/4	1/8	.812	.594	.375	.862	.437
169PS-4-4	1/4	1/4	.906	.688	.562	1.218	.562
169PS-6-2	3/8	1/8	.875	.625	.437	.904	.437
169PS-6-4	3/8	1/4	.937	.685	.562	1.218	.562
169PS-6-6	3/8	3/8	.859	.602	.562	1.190	.687
169PS-8-6	1/2	3/8	1.031	.782	.500	1.218	.687

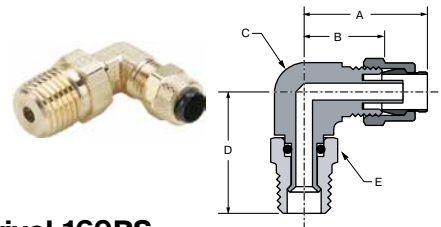

**WARNING** These products can expose you to chemicals including NICKEL or LEAD, which are known to the state of California to cause cancer, and LEAD which is known to cause birth defects or other reproductive harm. For more information go to [www.P65Warnings.ca.gov](http://www.P65Warnings.ca.gov).



- A
- B
- C
- D
- E
- F
- G
- H
- I
- J
- K
- L
- M
- N
- O

[Click here for CADs, Product Specifications or to Configure Parts Online](#)

- A
- B
- C
- D
- E
- F
- G
- H
- I
- J
- K
- L
- M
- N
- O

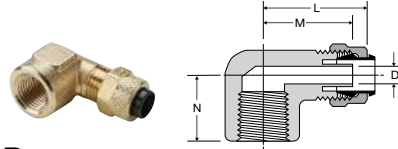

**Female Elbow 170P**

PART NO.	TUBE SIZE	PIPE THREAD	STRAIGHT THREAD	L	M	N	FLOW DIA. D
170P-4-2	1/4	1/8	3/8-24	.90	.79	.56	.125
170P-4-4	1/4	1/4	3/8-24	1.00	.89	.69	.125
170P-6-4	3/8	1/4	1/2-24	1.01	.89	.69	.204
170P-8-6	1/2	3/8	11/16-20	1.19	1.11	1.13	.323

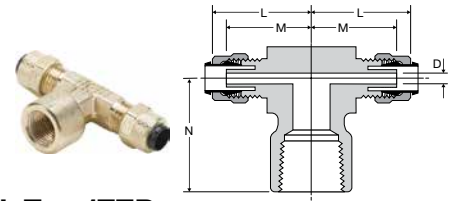

**Female Branch Tee 177P**

PART NO.	TUBE SIZE	PIPE THREAD	STRAIGHT THREAD	L	M	N	FLOW DIA. D
177P-4-2	1/4	1/8	3/8-24	.92	.81	.88	.125
177P-4-4	1/4	1/4	3/8-24	.92	.81	1.03	.125
177P-4-6	1/4	3/8	3/8-24	1.03	.92	1.13	.125

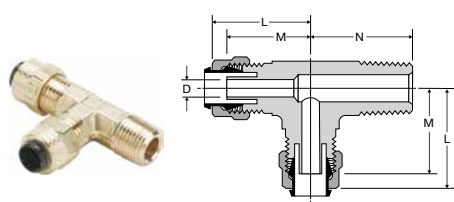

**Male Run Tee 171P**

PART NO.	TUBE SIZE	PIPE THREAD	STRAIGHT THREAD	L	M	N	FLOW DIA. D
171P-4-2	1/4	1/8	3/8-24	.84	.73	.72	.125
171P-4-4	1/4	1/4	3/8-24	.92	.81	.92	.125
171P-5-2	5/16	1/8	7/16-24	.83	.73	.72	.144
171P-6-4	3/8	1/4	1/2-24	.98	.86	1.03	.203
171P-8-6	1/2	3/8	11/16-20	1.12	1.04	1.13	.323

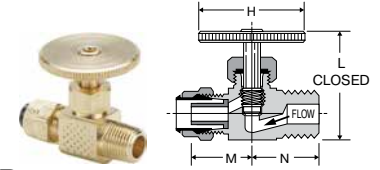

**Needle Valve NV311P**

PART NO.	TUBE SIZE	PIPE THREAD	H	L OPEN	L CLOSED	M	N
NV311P-4-2	1/4	1/8	1.06	1.36	1.16	.64	.63
NV311P-4-4	1/4	1/4	1.06	1.38	1.18	.64	.72
NV311P-6-4	3/8	1/4	1.06	1.38	1.18	.64	.72

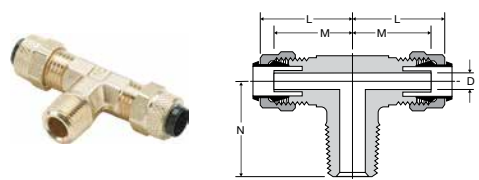

**Male Branch Tee 172P**

PART NO.	TUBE SIZE	PIPE THREAD	STRAIGHT THREAD	L	M	N	FLOW DIA. D
172P-4-2	1/4	1/8	3/8-24	.84	.73	.72	.125
172P-4-4	1/4	1/4	3/8-24	.92	.81	.92	.125
172P-5-2	5/16	1/8	7/16-24	.83	.73	.72	.144
172P-6-2	3/8	1/8	1/2-24	.88	.86	.74	.204
172P-6-4	3/8	1/4	1/2-24	.98	.86	1.03	.204
172P-8-6	1/2	3/8	11/16-20	1.12	1.04	1.13	.323

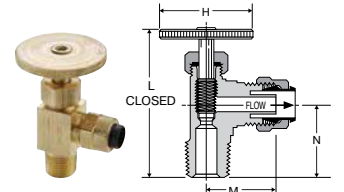

**Angle Needle Valve NV312P**

PART NO.	TUBE SIZE	PIPE THREAD	H	L OPEN	L CLOSED	M	N
NV312P-4-2	1/4	1/8	1.06	1.70	1.50	.63	.68
NV312P-4-4	1/4	1/4	1.06	2.07	1.82	.71	.86
NV312P-6-4	3/8	1/4	1.06	2.00	1.75	.74	.86

**WARNING** These products can expose you to chemicals including NICKEL or LEAD, which are known to the state of California to cause cancer, and LEAD which is known to cause birth defects or other reproductive harm. For more information go to [www.P65Warnings.ca.gov](http://www.P65Warnings.ca.gov).







# Hi-Duty Flareless Tube Fittings

Parker's Hi-Duty Fittings are preassembled with the sleeve machined onto the nut. During assembly the sleeve breaks away from the nut and creates a seal on the tubing. Rated to a much higher pressure rating than compression fittings, Hi-Duty will work with seamless steel tubing as well as copper, brass and thermoplastic tubing.

## Product Features:

- All brass construction
- Two piece fitting
- Higher pressure rating
- Easy assembly

## Markets:

- Mobile
- Industrial
- Compressors
- Lubrication

## Applications:

- Lubrication Lines
- Coolant Lines
- Oil Lines
- Engines

## Compatible Tubing:

- Copper
- Brass
- Seamless Steel
- Thermoplastic Tubing

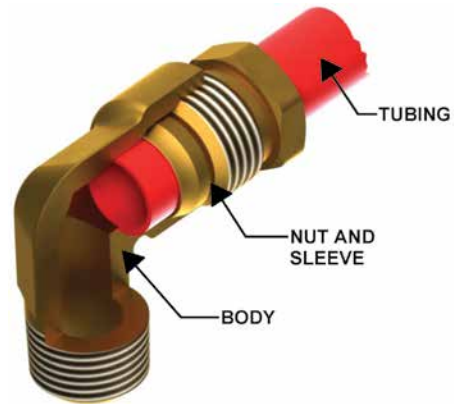

## Specifications:

**Temperature Range:** -65° to +250° F (-53.8° to +121.1° C)

## Pressure Range:

TUBE SIZE	PSI	bar	TUBE SIZE	PSI	bar
1/8	4300	296.4	3/8	1500	103.4
3/16	2850	196.5	1/2	1150	79.2
1/4	2100	144.7	5/8	1000	68.9
5/16	1800	124.1			

## Assembly Instructions

1. Cut tube squarely and cleanly removing all burrs.
2. Grasp fitting. Do not remove nut.
3. Insert tube in fitting through nut until tube seats firmly against tube shoulder in body.
4. Grip tube firmly to prevent turning and tighten nut to finger-tight. Continue to tighten for one and three-quarter additional turns (one and one-half turns for 1/2" size fittings) for a positive, leak proof seal. During tightening a slight "give" will be felt. This "give" indicates the sleeve has been sheared from the nut. It is not necessary to tighten the nut all the way down.



**WARNING** These products can expose you to chemicals including LEAD which is known to the state of California to cause cancer and birth defects or other reproductive harm. For more information go to [www.P65Warnings.ca.gov](http://www.P65Warnings.ca.gov).



Click here for CADs, Product Specifications or to Configure Parts Online

- A
- B
- C
- D
- E
- F
- G
- H
- I
- J
- K
- L
- M
- N
- O

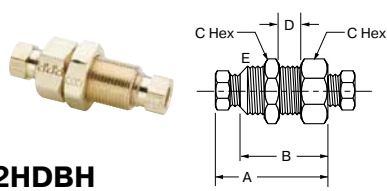

**Bulkhead Union 62HDBH**

PART NO.	TUBE SIZE	MIN. ORIFICE SIZE	A	B	C	D	E
62HDBH-2	1/8	.093	1.781	1.156	.562	.625	7/16-24
62HDBH-4	1/4	.187	1.968	1.156	.687	.625	9/16-24

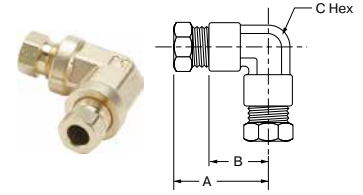

**Union Elbow 165HD**

PART NO.	TUBE SIZE	MIN. ORIFICE SIZE	A	B	C HEX
165HD-4	1/4	.187	1.084	.690	.552
165HD-6	3/8	.312	1.376	.970	.615
165HD-8	1/2	.437	1.546	1.060	.750

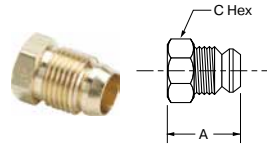

**Nut/Sleeve 61HD**

PART NO.	TUBE SIZE	PIPE THREAD	A	C
61HD-2	1/8	5/16-24	.656	.312
61HD-3	3/16	3/8-24	.687	.375
61HD-4	1/4	7/16-24	.734	.437
61HD-5	5/16	1/2-20	.765	.500
61HD-6	3/8	9/16-20	.843	.562
61HD-8	1/2	1 1/16-16	.921	.688
61HD-10	5/8	7/8-18	1.078	.875

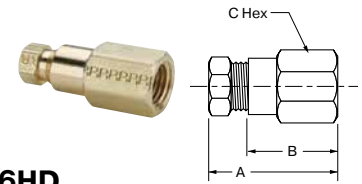

**Female Connector 66HD**

PART NO.	TUBE SIZE	PIPE THREAD	MIN. ORIFICE SIZE	A	B	C HEX
66HD-2-2	1/8	1/8	.093	1.312	1.000	.500
66HD-4-2	1/4	1/8	.187	1.406	1.000	.562
66HD-4-4	1/4	1/4	.187	1.593	1.187	.687
66HD-6-2	3/8	1/8	.312	1.531	1.125	.625
66HD-6-4	3/8	1/4	.312	1.718	1.312	.625
66HD-6-6	3/8	3/8	.312	1.750	1.343	.812

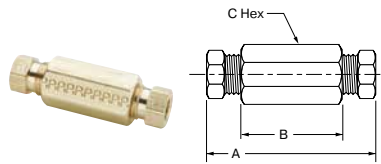

**Union 62HD**

PART NO.	TUBE SIZE	MIN. ORIFICE SIZE	A	B	C
62HD-2	1/8	.093	1.687	1.062	.375
62HD-3	3/16	.125	1.781	1.031	.437
62HD-4	1/4	.187	1.906	1.093	.562
62HD-6	3/8	.312	2.187	1.375	.625
62HD-8	1/2	.437	2.437	1.562	.812
62HD-10	5/8	.500	2.937	1.812	1.062

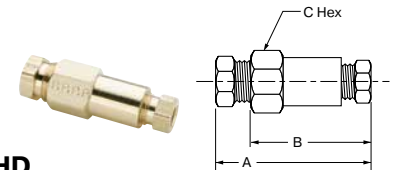

**Reducing Union 62HD**

PART NO.	TUBE SIZE	MIN. ORIFICE SIZE	A	B	C HEX
62HD-6-4	3/8 X 1/4	.187	2.000	1.187	.625
62HD-8-4	1/2 X 1/4	.187	2.125	1.281	.812
62HD-8-6	1/2 X 3/8	.312	2.656	1.406	.812

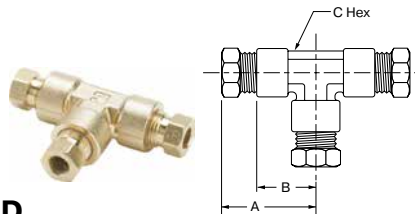

**Union Tee 164HD**

PART NO.	TUBE SIZE	MIN. ORIFICE SIZE	A	B	C HEX
164HD-4	1/4	.187	1.082	.687	.500
164HD-6	3/8	.312	1.357	.970	.562
164HD-8	1/2	.437	1.481	1.060	.750

**WARNING** These products can expose you to chemicals including LEAD which is known to the state of California to cause cancer and birth defects or other reproductive harm. For more information go to [www.P65Warnings.ca.gov](http://www.P65Warnings.ca.gov).



[Click here for CADs, Product Specifications or to Configure Parts Online](#)

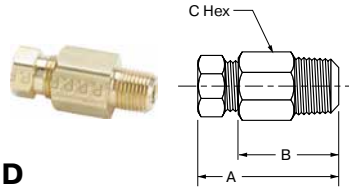

**Male Connector 68HD**

PART NO.	TUBE SIZE	PIPE THREAD	MIN. ORIFICE SIZE	A	B	C HEX
68HD-2-2	1/8	1/8	.093	1.062	.750	.437
68HD-3-2	3/16	1/8	.125	1.140	.765	.437
68HD-4-2	1/4	1/8	.187	1.343	.937	.562
68HD-4-4	1/4	1/4	.187	1.468	1.062	.562
68HD-4-6	1/4	3/8	.187	1.343	.937	.687
68HD-4-8	1/4	1/2	.187	1.531	1.125	.875
68HD-5-2	5/16	1/8	.218	1.406	1.000	.562
68HD-5-4	5/16	1/4	.218	1.500	1.093	.562
68HD-6-2	3/8	1/8	.218	1.531	1.125	.625
68HD-6-4	3/8	1/4	.312	1.656	1.250	.625
68HD-6-6	3/8	3/8	.312	1.531	1.125	.687
68HD-6-8	3/8	1/2	.312	1.531	1.125	.875
68HD-8-4	1/2	1/4	.312	1.813	1.375	.812
68HD-8-6	1/2	3/8	.406	1.750	1.312	.812
68HD-8-8	1/2	1/2	.437	1.812	1.375	.875
68HD-8-12	1/2	3/4	.437	1.625	1.187	1.062
68HD-10-6	5/8	3/8	.406	2.031	1.468	1.062
68HD-10-8	5/8	1/2	.500	2.156	1.593	1.062

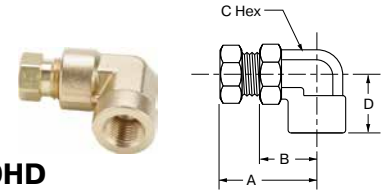

**Female Elbow 170HD**

PART NO.	TUBE SIZE	PIPE THREAD	MIN. ORIFICE SIZE	A	B	C HEX	D
170HD-2-2	1/8	1/8	.093	1.005	.690	.500	.750
170HD-4-2	1/4	1/8	.187	1.084	.687	.500	.750
170HD-4-4	1/4	1/4	.187	1.234	.843	.562	.875
170HD-6-2	3/8	1/8	.312	1.281	.875	.562	.937
170HD-6-4	3/8	1/4	.312	1.376	.970	.615	1.093
170HD-6-6	3/8	3/8	.312	1.526	1.120	.690	1.150
170HD-8-6	1/2	3/8	.437	1.481	1.062	.740	1.281

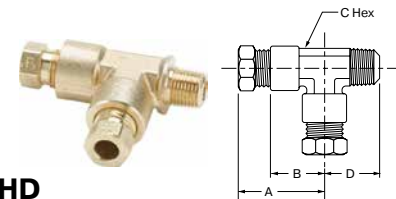

**Male Run Tee 171HD**

PART NO.	TUBE SIZE	PIPE THREAD	MIN. ORIFICE SIZE	A	B	C HEX	D
171HD-4-2	1/4	1/8	.187	1.144	.750	.500	.780
171HD-4-4	1/4	1/4	.187	1.207	.812	.500	.937
171HD-6-4	3/8	1/4	.312	1.376	.970	.562	1.000

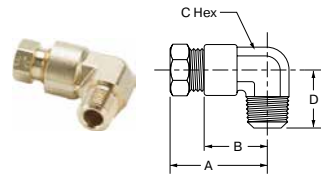

**Male Elbow 169HD**

PART NO.	TUBE SIZE	PIPE THREAD	MIN. ORIFICE SIZE	A	B	C HEX	D
169HD-2-2	1/8	1/8	.093	.975	.656	.438	.720
169HD-3-2	3/16	1/8	.125	1.056	.687	.437	.750
169HD-4-2	1/4	1/8	.187	1.084	.687	.500	.750
169HD-4-4	1/4	1/4	.187	1.144	.750	.500	.937
169HD-5-2	5/16	1/8	.218	1.144	.750	.562	.810
169HD-5-4	5/16	1/4	.250	1.206	.812	.562	1.000
169HD-6-2	3/8	1/8	.218	1.281	.875	.562	.875
169HD-6-4	3/8	1/4	.312	1.281	.875	.562	1.000
169HD-6-6	3/8	3/8	.312	1.376	.970	.615	1.031
169HD-6-8	3/8	1/2	.312	1.526	1.120	.687	1.310
169HD-8-4	1/2	1/4	.312	1.421	1.000	.678	1.062
169HD-8-6	1/2	3/8	.406	1.421	1.000	.678	1.062
169HD-8-8	1/2	1/2	.437	1.481	1.060	.740	1.420
169HD-10-6	5/8	3/8	.406	1.818	1.270	.875	1.340
169HD-10-8	5/8	1/2	.500	1.818	1.270	.875	1.480

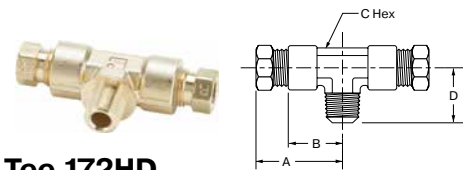

**Male Branch Tee 172HD**

PART NO.	TUBE SIZE	PIPE THREAD	MIN. ORIFICE SIZE	A	B	C HEX	D
172HD-4-2	1/4	1/8	.187	1.082	.687	.500	.780
172HD-4-4	1/4	1/4	.187	1.269	.875	.500	.937
172HD-6-6	3/8	3/8	.312	1.406	1.000	.562	1.125

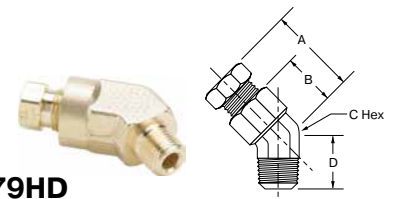

**45° Male Elbow 179HD**

PART NO.	TUBE SIZE	PIPE THREAD	MIN. ORIFICE SIZE	A	B	C HEX	D
179HD-4-2	1/4	1/8	.187	1.093	.687	.562	.750
179HD-6-4	3/8	1/4	.280	1.138	.710	.550	.850

**WARNING** These products can expose you to chemicals including LEAD which is known to the state of California to cause cancer and birth defects or other reproductive harm. For more information go to [www.P65Warnings.ca.gov](http://www.P65Warnings.ca.gov).



- A
- B
- C
- D
- E
- F
- G
- H
- I
- J
- K
- L
- M
- N
- O

[Click here for CADs, Product Specifications or to Configure Parts Online](#)

- A
- B
- C
- D
- E
- F
- G
- H
- I
- J
- K
- L
- M
- N
- O

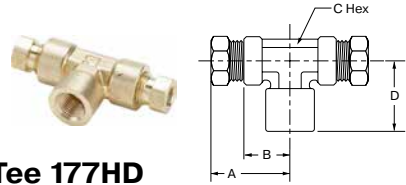

**Female Branch Tee 177HD**

PART NO.	TUBE SIZE	PIPE THREAD	MIN. ORIFICE SIZE	A	B	C HEX	D
177HD-4-2	1/4	1/8	.187	1.082	.687	.500	.750
177HD-4-4	1/4	1/4	.187	1.144	.750	.562	1.093
177HD-6-4	3/8	1/4	.312	1.376	.970	.562	1.093

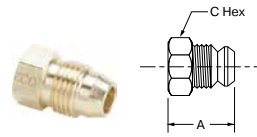

**Plug 59HD**

PART NO.	TUBE SIZE	A	C
59HD-4	1/4	.734	.437
59HD-6	3/8	.843	.625

**WARNING** These products can expose you to chemicals including LEAD which is known to the state of California to cause cancer and birth defects or other reproductive harm. For more information go to [www.P65Warnings.ca.gov](http://www.P65Warnings.ca.gov).







# Industrial Flare Fittings

45° Flare Fittings

Inverted Flared Fittings

Access Valves



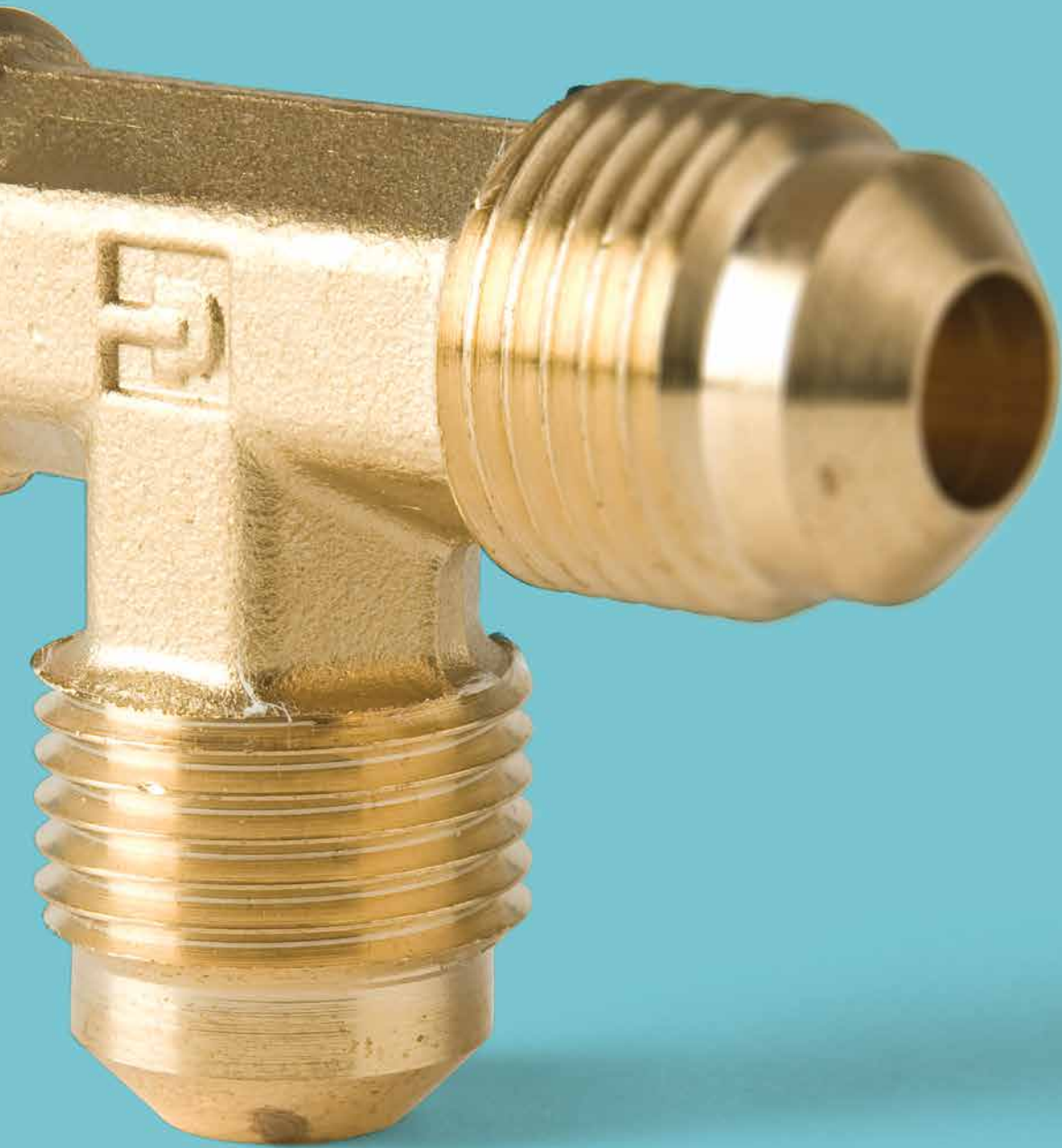

**Flare to Male NPT**

**48F**

Male Connector  
p. H9



**145F**

Branch Tee  
p. H10



**149F-249F**

Male Elbow  
p. H10



**151F**

Run Tee  
p. H11



**159F-259F**

45° Male Elbow  
p. H12



**256F**

Adapter Tee  
p. H13



**48IFHD**

Male Connector  
p. H15



**245IFHD**

Branch Tee  
p. H16



**249IFHD-249IF**

Male Elbow  
p. H16



**251IFHD**

Run Tee  
p. H16



**259IFHD**

45° Male Elbow  
p. H16



**AVU1**

Male Connector  
p. H18



**AVE1**

Male Elbow  
p. H18



**AVT3**

Run Tee  
p. H18



**AVC1**

Cross  
p. H18



**Flare to Straight Thread**

**485F**

Male Connector  
p. H9



**1495F**

Male Elbow  
p. H12



**1595F**

45° Male Elbow  
p. H12



**AVUIFI**

Male Connector  
p. H18



**Flare to Solder**

**US5**

Flare Adapter  
p. H7



**43F**

Connector  
p. H8



**AVUSE**

Extended Copper  
Tube  
p. H18



**AVTS**

Solder Tee  
p. H18



**AVUS3**

3 Way Solder  
p. H19



**AVUS**

Solder Connector  
p. H19



**Flare to Female NPT**

**46F**

Female Connector  
p. H9



**150F**

Female Elbow  
p. H11



**46IFHD**

Female Connector  
p. H15



**250IFHD**

Female Elbow  
p. H16



**252IFHD**

Branch Tee  
p. H16



**WARNING** These products can expose you to chemicals including LEAD which is known to the state of California to cause cancer and birth defects or other reproductive harm. For more information go to [www.P65Warnings.ca.gov](http://www.P65Warnings.ca.gov).





**Flare to Flare**

**14FSV**  
Swivel Nut Connector  
p. H7



**42F**  
Union  
p. H8



**144F-244F**  
Union Tee  
p. H10



**155F**  
Union Elbow  
p. H11



**166FSV**  
Swivel Elbow  
p. H12



**660FHD**  
Union  
p. H13



**421FHD**  
Union  
p. H15



**2441FHD**  
Union Tee  
p. H15



**2551FHD**  
Branch Tee  
p. H16



**AVU2**  
Union  
p. H18



**AVUR3**  
Female Connector  
p. H18



**AVUS4D**  
Swivel Connector  
p. H19



**AVTS4**  
Run Tee  
p. H19



**AVTS6**  
Branch Tee  
p. H19



**Flare to Metric Straight Thread**

**48F-X-MIX**  
Male Connector  
p. H9



**149F-X-MIX**  
Male Elbow  
p. H12



**159F-X-MIX**  
45° Male Elbow  
p. H12



**Bulkhead Union**

**AVU2BH**  
Bulkhead Union  
p. H18



**AVUS3BH**  
Bulkhead Union  
p. H18



**Adapter**

**1F**  
Refrigerant Drum  
p. H7



**661FHD**  
Reducer  
p. H13



**664FHD**  
Female Flare – Pipe  
p. H13



**88AC**  
Refrigerant Adapter  
p. H19



**880AC**  
Refrigerant Adapter  
p. H19



**881AC**  
Refrigerant Adapter  
p. H19



**Accessories**

**2GF**  
Flare Gasket  
p. H7



**3GF**  
Seal Bonnet  
p. H7



**14FL**  
Long Forged Nut  
p. H7



**14FS**  
Short Forged Nut  
p. H7



**14FSX**  
Short Forged Nut  
p. H7



**41FL**  
Long Nut  
p. H8



**41FS/41FX**  
Short Nut  
p. H8



**639F**  
Seal Plug  
p. H13



**640F**  
Cap Nut  
p. H13



**411F**  
Inverted Flare Nut  
p. H15



**411FS**  
Inverted Flare Nut  
p. H15



**411FF**  
Inverted Flare  
Pilot Nut  
p. H15



**640QS**  
Seal Cap  
p. H19



**640QSFCR**  
Seal Cap with Core  
Remover  
p. H19



**CR**  
Core Remover  
p. H19



**VC**  
Valve Core  
p. H19



**WARNING** These products can expose you to chemicals including LEAD which is known to the state of California to cause cancer and birth defects or other reproductive harm. For more information go to [www.P65Warnings.ca.gov](http://www.P65Warnings.ca.gov).

A  
B  
C  
D  
E  
F  
G  
H  
I  
J  
K  
L  
M  
N  
O

A  
B  
C  
D  
E  
F  
G  
H  
I  
J  
K  
L  
M  
N  
O



# 45° Flare Fittings

Parker's Flare Fittings is an economical choice for a metal-to-metal seal that resists mechanical pullout. Meets functional requirements of SAE J512 and SAE J513.

### Product Features:

- All brass construction
- Resists vibration with use of long nut
- UL listing
- Functional requirements of SAE J512 and J513

### Applications:

- Refrigerant Lines
- Propane
- Fuels
- Adapters
- Natural Gas

### Markets:

- Refrigeration
- Heavy Duty Truck
- Mobile
- Industrial
- Heating
- Air Conditioning

### Compatible Tubing:

- Copper
- Brass
- Aluminum
- Welded Steel Hydraulic Tubing



### Specifications:

**Temperature Range:** -65° to +250° F (-53.8° to 121.1° C)

### Pressure Range:

TUBE SIZE	PSI	bar	TUBE SIZE	PSI	bar
1/8	2800	193.0	3/8	1000	68.9
3/16	1900	131.0	1/2	750	51.7
1/4	1400	96.5	5/8	650	44.8
5/16	1200	82.7	3/4	550	37.9

### Assembly Instructions

1. Cut tubing squarely and clean tube end thoroughly to remove burrs.
2. Place nut onto tube. Place threaded end of nut toward end of tube.
3. Flare tube end with flaring tool to provide 45° flare.
4. Clamp tube flare between nut and nose of fitting body by screwing nut on finger-tight. Tighten with a wrench an additional 1/4 to 1/2 turn past finger-tight for a metal-to-metal seal.



**WARNING** These products can expose you to chemicals including LEAD which is known to the state of California to cause cancer and birth defects or other reproductive harm. For more information go to [www.P65Warnings.ca.gov](http://www.P65Warnings.ca.gov).



Click here for CADs, Product Specifications or to Configure Parts Online

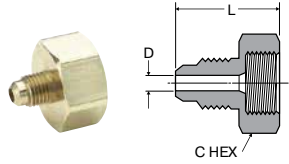

### Refrigerant Drum Adapter 1F

Ref. SAE 010165

PART NO.	TUBE O.D.	PIPE THREAD	C HEX	L	FLOW DIA. D
1F-4-8	1/4	1/2	1-1/8	1.12	.189
1F-4-12*	1/4	3/4	1-1/4	1.12	.189
1F-6-12*	3/8	3/4	1-1/4	1.24	.282
1F-8-12*	1/2	3/4	1-1/4	1.37	.407

Gasket Furnished with each 1F adapter

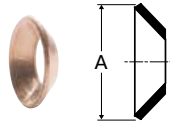

### Copper Flare Gasket 2GF

REF. SAE 010113

PART NO.	TUBE SIZE	A
2GF-3	3/16	.32
2GF-4	1/4	.36
2GF-5	5/16	.43
2GF-6	3/8	.56
2GF-8	1/2	.67
2GF-10	5/8	.78
2GF-12	3/4	.97

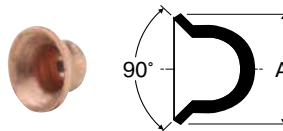

### Seal Bonnet 3GF

REF. SAE 010114

PART NO.	TUBE SIZE	A
3GF-3	3/16	.32
3GF-4	1/4	.37
3GF-5	5/16	.43
3GF-6	3/8	.56
3GF-8	1/2	.67
3GF-10	5/8	.78
3GF-12	3/4	.97

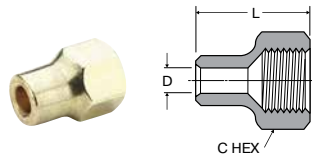

### Long Forged Nut 14FL

REF. SAE 010167

PART NO.	TUBE SIZE	STRAIGHT THREAD	C HEX	D	L
14FL-4	1/4	7/16-20	5/8	.257	.94
14FL-6	3/8	5/8-18	13/16	.382	1.06
14FL-8	1/2	3/4-16	15/16	.507	1.19
14FL-10	5/8	7/8-14	1-1/16	.632	1.44

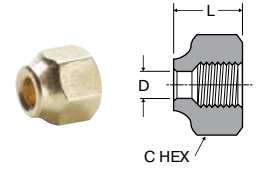

### Short Forged Nut 14FSX

REF. SAE 010166

PART NO.	TUBE SIZE	STRAIGHT THREAD	C HEX	D	L
14FSX-4	1/4	7/16-20	5/8	.257	.63
14FSX-5	5/16	1/2-20	11/16	.320	.67
14FSX-6	3/8	5/8-18	13/16	.382	.74
14FSX-8	1/2	3/4-16	15/16	.507	.86
14FSX-10	5/8	7/8-14	1-1/16	.632	.97
14FSX-12	3/4	1-1/16-14	1-5/16	.757	1.17

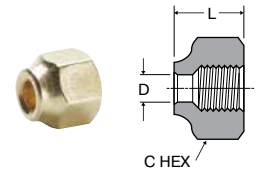

### Short Forged Reducing Nuts 14FS

PART NO.	TUBE SIZE	STRAIGHT THREAD	C HEX	D	L
14FS-6-4	3/8 TO 1/4	5/8-18	13/16	.257	.74
14FS-8-6	1/2 TO 3/8	3/4-16	15/16	.382	.86
14FS-10-8	5/8 TO 1/2	7/8-14	1-1/16	.507	.99

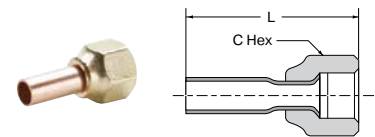

### Flare Adapter US5

PART NO.	TUBE SIZE	STRAIGHT THREAD	C HEX	L
US5-4	1/4	7/16-20	5/8	1.50
US5-6	3/8	5/8-18	13/16	1.58
US5-8	1/2	3/4-16	15/16	1.80

**WARNING** These products can expose you to chemicals including LEAD which is known to the state of California to cause cancer and birth defects or other reproductive harm. For more information go to [www.P65Warnings.ca.gov](http://www.P65Warnings.ca.gov).



- A
- B
- C
- D
- E
- F
- G
- H
- I
- J
- K
- L
- M
- N
- O

[Click here for CADs, Product Specifications or to Configure Parts Online](#)

- A
- B
- C
- D
- E
- F
- G
- H
- I
- J
- K
- L
- M
- N
- O

### Long Nut 41FL

REF. SAE 010111

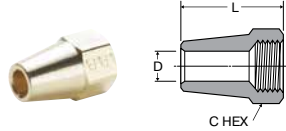

PART NO.	TUBE SIZE	STRAIGHT THREAD	C HEX	D	L
41FL-2	1/8	5/16-24	3/8	.133	.75
41FL-3	3/16	3/8-24	7/16	.195	.81
41FL-4	1/4	7/16-20	9/16	.257	.94
41FL-5	5/16	1/2-20	5/8	.320	1.12
41FL-6	3/8	5/8-18	3/4	.382	1.31
41FL-8	1/2	3/4-16	7/8	.507	1.62
41FL-10	5/8	7/8-14	1-1/16	.632	1.88
41FL-12	3/4	1-1/16-14	1-1/4	.757	2.19

### Short Nut 41FS / Shorter Nut 41FX

REF. SAE 010110

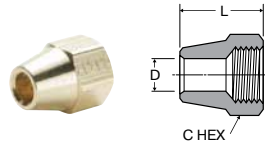

PART NO.	TUBE SIZE	STRAIGHT THREAD	C HEX	D	L
41FS-2	1/8	5/16-24	3/8	.132	.50
41FS-3	3/16	3/8-24	7/16	.195	.62
41FS-4	1/4	7/16-20	9/16	.257	.75
41FS-5	5/16	1/2-20	5/8	.320	.88
41FS-6	3/8	5/8-18	3/4	.382	1.00
41FX-6	3/8	5/8-18	3/4	.382	.91
41FS-8	1/2	3/4-16	7/8	.507	1.12
41FX-8	1/2	3/4-16	7/8	.507	1.00
41FS-10	5/8	7/8-14	1-1/16	.632	1.31
41FX-10	5/8	7/8-14	1-1/16	.632	1.06
41FX-12	3/4	1-1/16-14	1-1/4	.757	1.17
41FS-12	3/4	1-1/16-14	1-1/4	.757	1.50
41FS-14	7/8	1-1/4-12	1-1/2	.882	1.62

### Union 42F

REF. SAE 010101 \*THREAD PROTECTORS

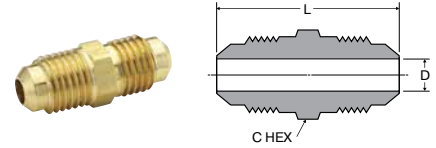

PART NO.	TUBE SIZE	STRAIGHT THREAD	C HEX	L	D
42F-2	1/8	5/16-24	5/16	.90	.079
42F-3	3/16	3/8-24	3/8	1.04	.125
42F-4	1/4	7/16-20	7/16	1.17	.189
42F-5	5/16	1/2-20	1/2	1.32	.220
42F-6	3/8	5/8-18	5/8	1.48	.282
42F-8	1/2	3/4-16	3/4	1.79	.407
42F-10	5/8	7/8-14	7/8	2.10	.501
42F-12*	3/4	1-1/16-14	1-1/16	2.42	.626
42F-14*	7/8	1-1/4-12	1-1/4	2.72	.751

### Union Reducers 42F

REF. SAE 010101

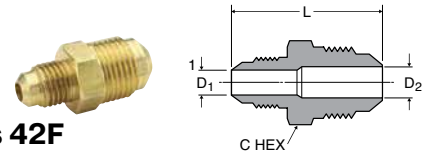

PART NO.	1 TUBE SIZE	2 TUBE SIZE	1 STRAIGHT THREAD	2 STRAIGHT THREAD	C HEX	L	FLOW DIA. D1	FLOW DIA. D2
42F-6-4	1/4	3/8	7/16-20	5/8-18	5/8	1.36	.189	.282
42F-6-5	5/16	3/8	1/2-20	5/8-18	5/8	1.42	.220	.282
42F-8-4	1/4	1/2	7/16-20	3/4-16	3/4	1.54	.189	.407
42F-8-6	3/8	1/2	5/8-18	3/4-16	3/4	1.67	.282	.407
42F-10-6	3/8	5/8	5/8-18	7/8-14	7/8	1.86	.282	.501
42F-10-8	1/2	5/8	3/4-16	7/8-14	7/8	1.98	.407	.501

### Flare to Solder 43F

REF. SAE 010104

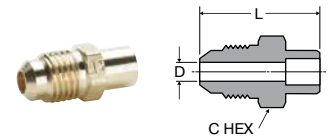

PART NO.	TUBE SIZE	SOLDER OD	STRAIGHT THREAD	C HEX	L	FLOW DIA. D
43F-4-4	1/4	1/4	7/16-20	7/16	.98	.189
43F-4-5	1/4	5/16	7/16-20	7/16	.98	.189
43F-4-6	1/4	3/8	7/16-20	1/2	.98	.189
43F-6-4	3/8	1/4	5/8-18	5/8	1.17	.189
43F-6-5	3/8	5/16	5/8-18	5/8	1.17	.252
43F-6-6	3/8	3/8	5/8-18	5/8	1.17	.282
43F-6-8	3/8	1/2	5/8-18	5/8	1.23	.282
43F-6-10	3/8	5/8	5/8-18	3/4	1.36	.282
43F-8-6	1/2	3/8	3/4-16	3/4	1.36	.314
43F-8-8	1/2	1/2	3/4-16	3/4	1.42	.407
43F-8-10	1/2	5/8	3/4-16	3/4	1.54	.407
43F-10-8	5/8	1/2	7/8-14	7/8	1.60	.440
43F-10-10	5/8	5/8	7/8-14	7/8	1.73	.501
43F-10-12*	5/8	3/4	7/8-14	7/8	1.86	.501
43F-12-12*	3/4	3/4	1-1/16-14	1-1/16	2.04	.626
43F-12-14*	3/4	7/8	1-1/16-14	1-1/16	2.17	.626

\*Comes standard with thread protectors

**WARNING** These products can expose you to chemicals including LEAD which is known to the state of California and birth defects or other reproductive harm. For more information go to [www.P65Warnings.ca.gov](http://www.P65Warnings.ca.gov).



[Click here for CADs, Product Specifications or to Configure Parts Online](#)

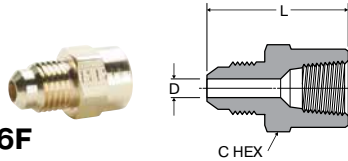

### Female Connector 46F

REF. SAE 010103

PART NO.	TUBE SIZE	PIPE THREAD	STRAIGHT THREAD	C HEX	L	FLOW DIA. D
46F-2-2	1/8	1/8	5/16-24	9/16	.91	.078
46F-3-2	3/16	1/8	3/8-24	9/16	.95	.125
46F-4-2	1/4	1/8	7/16-20	9/16	1.01	.189
46F-4-4	1/4	1/4	7/16-20	11/16	1.23	.189
46F-4-6	1/4	3/8	7/16-20	13/16	1.26	.189
46F-5-2	5/16	1/8	1/2-20	9/16	1.05	.220
46F-5-4	5/16	1/4	1/2-20	11/16	1.26	.220
46F-6-2	3/8	1/8	5/8-18	5/8	1.10	.282
46F-6-4	3/8	1/4	5/8-18	11/16	1.29	.282
46F-6-6	3/8	3/8	5/8-18	13/16	1.36	.282
46F-6-8	3/8	1/2	5/8-18	1	1.60	.282
46F-8-4	1/2	1/4	3/4-16	3/4	1.39	.407
46F-8-6	1/2	3/8	3/4-16	13/16	1.48	.407
46F-8-8	1/2	1/2	3/4-16	1	1.73	.407
46F-8-12*	1/2	3/4	3/4-16	1-1/4	1.79	.407
46F-10-6	5/8	3/8	7/8-14	7/8	1.57	.501
46F-10-8	5/8	1/2	7/8-14	1	1.80	.501
46F-10-12*	5/8	3/4	7/8-14	1-1/4	1.89	.501

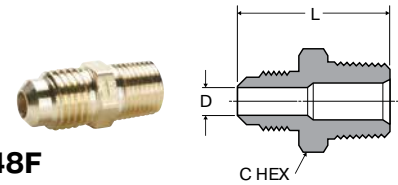

### Male Connector 48F

REF. SAE 010102

PART NO.	TUBE SIZE	PIPE THREAD	STRAIGHT THREAD	C HEX	L	FLOW DIA. D
48F-2-2	1/8	1/8	5/16-24	7/16	.91	.078
48F-3-2	3/16	1/8	3/8-24	7/16	.98	.125
48F-3-4	3/16	1/4	3/8-24	9/16	1.17	.125
48F-4-2	1/4	1/8	7/16-20	7/16	1.04	.189
48F-4-4	1/4	1/4	7/16-20	9/16	1.23	.189
48F-4-6	1/4	3/8	7/16-20	11/16	1.29	.189
48F-4-8	1/4	1/2	7/16-20	7/8	1.54	.189
48F-5-2	5/16	1/8	1/2-20	1/2	1.14	.220
48F-5-4	5/16	1/4	1/2-20	9/16	1.32	.220
48F-5-6	5/16	3/8	1/2-20	11/16	1.36	.220
48F-6-2	3/8	1/8	5/8-18	5/8	1.23	.220
48F-6-4	3/8	1/4	5/8-18	5/8	1.42	.282
48F-6-6	3/8	3/8	5/8-18	11/16	1.42	.282
48F-6-8	3/8	1/2	5/8-18	7/8	1.67	.282
48F-6-12*	3/8	3/4	5/8-18	1-1/16	1.79	.282
48F-8-4	1/2	1/4	3/4-16	3/4	1.60	.407
48F-8-6	1/2	3/8	3/4-16	3/4	1.60	.407
48F-8-8	1/2	1/2	3/4-16	7/8	1.79	.407
48F-8-12	1/2	3/4	3/4-16	1-1/16	1.92	.407
48F-10-4	5/8	1/4	7/8-14	7/8	1.79	.313
48F-10-6	5/8	3/8	7/8-14	7/8	1.79	.408
48F-10-8	5/8	1/2	7/8-14	7/8	1.98	.501
48F-10-12*	5/8	3/4	7/8-14	1-1/16	2.04	.501
48F-12-8*	3/4	1/2	1-1/16-14	1-1/16	2.17	.563
48F-12-12*	3/4	3/4	1-1/16-14	1-1/16	2.17	.626
48F-14-12*	7/8	3/4	1-1/4-12	1-1/4	2.35	.751

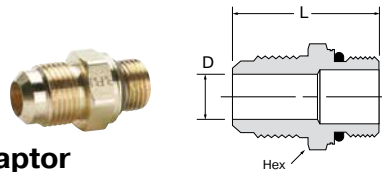

### Flare to Metric Adaptor 48F-X-MIX

PART NUMBER	TUBE SIZE	METRIC THREAD	STRAIGHT THREAD TUBE	HEX	L	D
48F-8-MI16	1/2	M16 X 1.5	3/4-16	7/8	1.60	.35
48F-10-MI27	5/8	M27 X 2.0	7/8-14	1 1/4	1.87	.50
48F-12-MI27*	3/4	M27 X 2.0	1 1/16-14	1 1/4	1.99	.63

Note: Fluorocarbon o-ring is standard

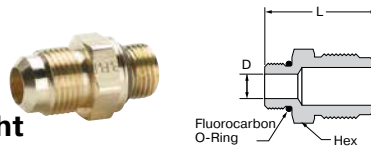

### Flare to SAE Straight Thread 485F

PART NO.	TUBE SIZE	STRAIGHT THREAD	STRAIGHT THREAD TUBE	HEX	L	FLOW DIA. D
485F-12-8*	3/4	3/4-16	1 1/16-14	1 1/16	1.80	.397
485F-12-12*	3/4	1 1/16-12	1 1/16-14	1 1/4	2.03	.615

\*Comes standard with thread protectors

**WARNING** These products can expose you to chemicals including LEAD which is known to the state of California to cause cancer and birth defects or other reproductive harm. For more information go to [www.P65Warnings.ca.gov](http://www.P65Warnings.ca.gov).

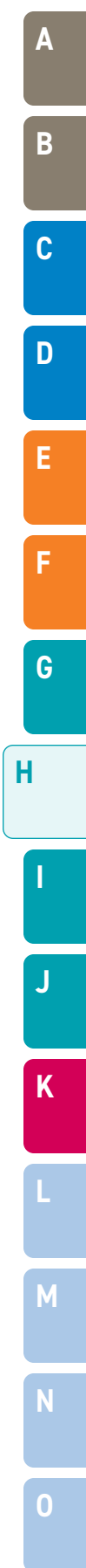

[Click here for CADs, Product Specifications or to Configure Parts Online](#)

- A
- B
- C
- D
- E
- F
- G
- H
- I
- J
- K
- L
- M
- N
- O

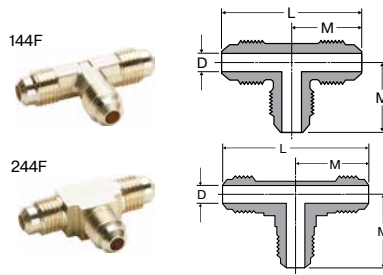

**Union Tee 144F-244F**

REF. SAE 010401

PART NO.	TUBE SIZE	STRAIGHT THREAD	L	M	FLOW DIA. D
144F-3	3/16	3/8-24	1.46	.73	.125
144F-4	1/4	7/16-20	1.72	.86	.189
244F-4	1/4	7/16-20	1.72	.86	.189
144F-5	5/16	1/2-20	1.82	.91	.220
144F-6	3/8	5/8-18	2.08	1.04	.282
144F-8	1/2	3/4-16	2.46	1.23	.407
144F-10	5/8	7/8-14	2.78	1.39	.501

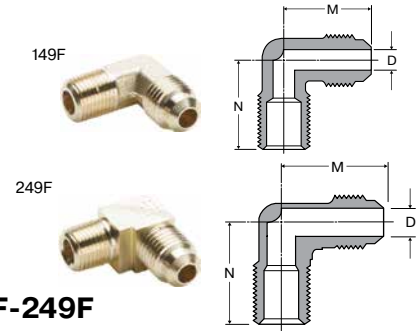

**Male Elbow 149F-249F**

REF. SAE 010202

PART NO.	TUBE SIZE	PIPE THREAD	STRAIGHT THREAD	M	N	FLOW DIA. D
149F-2-2	1/8	1/8	5/16-24	.63	.69	.079
149F-3-2	3/16	1/8	3/8-24	.75	.75	.125
249F-3-2	3/16	1/8	3/8-24	.73	.73	.125
149F-4-2	1/4	1/8	7/16-20	.79	.76	.189
249F-4-2	1/4	1/8	7/16-20	.79	.76	.189
149F-4-4	1/4	1/4	7/16-20	.89	.92	.189
249F-4-4	1/4	1/4	7/16-20	.89	.92	.189
149F-4-6	1/4	3/8	7/16-20	.92	1.01	.189
249F-4-6	1/4	3/8	7/16-20	.92	1.01	.189
149F-4-8	1/4	1/2	7/16-20	1.02	1.26	.189
149F-5-2	5/16	1/8	1/2-20	.90	.79	.220
249F-5-2	5/16	1/8	1/2-20	.89	.77	.220
149F-5-4	5/16	1/4	1/2-20	.95	.95	.220
249F-5-4	5/16	1/4	1/2-20	.95	.92	.220
149F-5-6	5/16	3/8	1/2-20	.98	1.01	.220
149F-6-2*	3/8	1/8	5/8-18	1.01	.90	.220
249F-6-2*	3/8	1/8	5/8-18	1.01	.89	.220
149F-6-4	3/8	1/4	5/8-18	1.01	1.05	.282
249F-6-4	3/8	1/4	5/8-18	.98	1.04	.282
149F-6-6	3/8	3/8	5/8-18	1.04	1.07	.282
249F-6-6	3/8	3/8	5/8-18	1.04	1.07	.282
149F-6-8	3/8	1/2	5/8-18	1.15	1.26	.282
249F-6-8	3/8	1/2	5/8-18	1.14	1.26	.282
149F-6-12*	3/8	3/4	5/8-18	1.25	1.38	.282
149F-8-4*	1/2	1/4	3/4-16	1.20	1.17	.314
149F-8-6	1/2	3/8	3/4-16	1.20	1.10	.407
249F-8-6	1/2	3/8	3/4-16	1.20	1.10	.407
149F-8-8	1/2	1/2	3/4-16	1.28	1.38	.407
249F-8-8	1/2	1/2	3/4-16	1.26	1.36	.407
149F-8-12*	1/2	3/4	3/4-16	1.38	1.38	.407
149F-10-4*	5/8	1/4	7/8-14	1.41	1.25	.314
149F-10-6*	5/8	3/8	7/8-14	1.41	1.25	.407
149F-10-8	5/8	1/2	7/8-14	1.40	1.39	.501
249F-10-8	5/8	1/2	7/8-14	1.39	1.36	.501
149F-10-12*	5/8	3/4	7/8-14	1.42	1.48	.501
149F-12-8**	3/4	1/2	1-1/16-14	1.60	1.48	.563
149F-12-12*	3/4	3/4	1-1/16-14	1.60	1.62	.626



**Union Tee 144F combination sizes**

PART NO.	1 TUBE SIZE	2 TUBE SIZE	3 TUBE SIZE	L	M	M1	FLOW DIA. D
144F-6-6-4	3/8	3/8	1/4	2.08	1.04	.89	.189
144F-8-8-6	1/2	1/2	3/8	2.40	1.20	1.10	.282

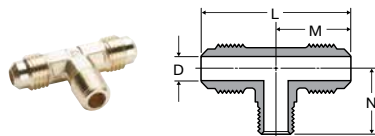

**Male Branch Tee 145F**

REF. SAE 010425

PART NO.	TUBE SIZE	PIPE THREAD	STRAIGHT THREAD	L	M	N	FLOW DIA. D
145F-2-2	1/8	1/8	5/16-24	1.26	.63	.69	.079
145F-4-2	1/4	1/8	7/16-20	1.58	.79	.76	.189
145F-4-4	1/4	1/4	7/16-20	1.78	.89	.92	.189
145F-5-4	5/16	1/4	1/2-20	1.90	.95	.96	.220
145F-6-4	3/8	1/4	5/8-18	1.96	.98	1.05	.282
145F-6-6	3/8	3/8	5/8-18	2.00	1.00	.98	.282
145F-6-8	3/8	1/2	5/8-18	2.28	1.14	1.26	.282
145F-8-6	1/2	3/8	3/4-16	2.40	1.20	1.10	.407
145F-8-8	1/2	1/2	3/4-16	2.46	1.23	1.36	.407
145F-10-8	5/8	1/2	7/8-14	2.78	1.39	1.36	.501

\* For these parts the pipe thread through hole is smaller than the through hole on the flare end.

\*Comes standard with thread protectors

**WARNING** These products can expose you to chemicals including LEAD which is known to the state of California to cause cancer and birth defects or other reproductive harm. For more information go to [www.P65Warnings.ca.gov](http://www.P65Warnings.ca.gov).



Click here for CADs, Product Specifications or to Configure Parts Online

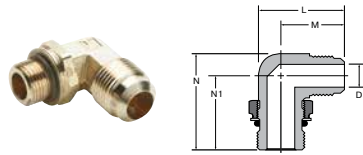

### Flare Elbow to SAE Metric Straight Thread 149F-X-MIX

PART NUMBER	TUBE SIZE	METRIC THREAD	STRAIGHT THREAD TUBE	L	M	N	N1	D
149F-10-MI27	5/8	M27 X 2.0	7/8-14	1.95	1.46	2.12	1.63	.501

Note: Fluorocarbon o-ring is standard

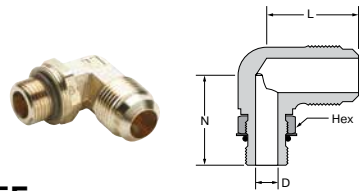

### Flare Elbow to SAE Straight Thread 1495F

PART NO.	TUBE SIZE	STRAIGHT THREAD	STRAIGHT THREAD TUBE	HEX	L	N	FLOW DIA. D
1495F-12-8*	3/4	3/4-16	1 1/16-14	7/8	1.60	1.60	.398
1495F-12-12*	3/4	1-1/16-12	1 1/16-14	1 1/4	1.59	2.12	.616

Note: Fluorocarbon o-ring is standard

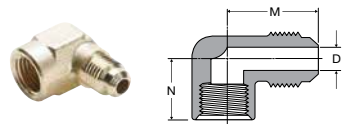

### Female Elbow 150F

REF. SAE 010203

PART NO.	TUBE SIZE	PIPE THREAD	STRAIGHT THREAD	M	N	FLOW DIA. D
150F-4-2	1/4	1/8	7/16-20	.86	.50	.189
150F-4-4	1/4	1/4	7/16-20	.95	.67	.189
150F-5-4	5/16	1/4	1/2-20	1.01	.67	.220
150F-6-2	3/8	1/8	5/8-18	1.08	.48	.282
150F-6-4	3/8	1/4	5/8-18	1.07	.67	.282
150F-6-6	3/8	3/8	5/8-18	1.14	.67	.282
150F-6-8	3/8	1/2	5/8-18	1.23	.86	.282
150F-8-6	1/2	3/8	3/4-16	1.25	.69	.407
150F-8-8	1/2	1/2	3/4-16	1.36	.92	.407
150F-8-12	1/2	3/4	3/4-16	1.51	.92	.407
150F-10-8*	5/8	1/2	7/8-14	1.48	.98	.501
150F-10-12*	5/8	3/4	7/8-14	1.64	.98	.501

\*Comes standard with thread protectors

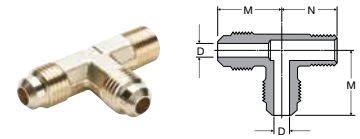

### Male Run Tee 151F

REF. SAE 010424

PART NO.	TUBE SIZE	PIPE THREAD	STRAIGHT THREAD	M	N	FLOW DIA. D
151F-4-2	1/4	1/8	7/16-20	.86	.76	.189
151F-4-4	1/4	1/4	7/16-20	.89	.92	.189
151F-5-4	5/16	1/4	1/2-20	.95	.92	.220
151F-6-4	3/8	1/4	5/8-18	1.04	1.04	.282
151F-6-6	3/8	3/8	5/8-18	1.00	.98	.282
151F-6-8	3/8	1/2	5/8-18	1.16	1.26	.282
151F-8-6	1/2	3/8	3/4-16	1.20	1.10	.407
151F-8-8	1/2	1/2	3/4-16	1.23	1.36	.407
151F-10-8	5/8	1/2	7/8-14	1.39	1.36	.501

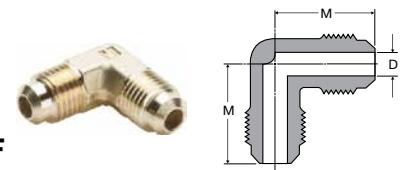

### Union Elbow 155F

REF. SAE 010201

PART NO.	TUBE SIZE	STRAIGHT THREAD	M	FLOW DIA. D
155F-2	1/8	5/16-24	.64	.079
155F-3	3/16	3/8-24	.73	.125
155F-4	1/4	7/16-20	.86	.189
155F-5	5/16	1/2-20	.92	.220
155F-6	3/8	5/8-18	1.04	.282
155F-8	1/2	3/4-16	1.20	.407
155F-10	5/8	7/8-14	1.39	.501
155F-12*	3/4	1-1/16-14	1.64	.626

**WARNING** These products can expose you to chemicals including LEAD which is known to the state of California to cause cancer and birth defects or other reproductive harm. For more information go to [www.P65Warnings.ca.gov](http://www.P65Warnings.ca.gov).



- A
- B
- C
- D
- E
- F
- G
- H
- I
- J
- K
- L
- M
- N
- O

[Click here for CADs, Product Specifications or to Configure Parts Online](#)

- A
- B
- C
- D
- E
- F
- G
- H
- I
- J
- K
- L
- M
- N
- O

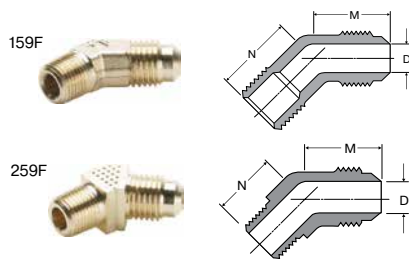

### 45° Elbow 159F-259F

REF. SAE 010302

PART NO.	TUBE SIZE	PIPE THREAD	STRAIGHT THREAD	M	N	FLOW DIA. D
159F-4-2	1/4	1/8	7/16-20	.78	.56	.189
259F-4-2	1/4	1/8	7/16-20	.65	.62	.189
159F-4-4	1/4	1/4	7/16-20	.75	.84	.189
259F-4-4	1/4	1/4	7/16-20	.73	.84	.189
159F-5-2	5/16	1/8	1/2-20	.76	.65	.220
159F-5-4	5/16	1/4	1/2-20	.75	.81	.220
159F-6-2*	3/8	1/8	5/8-18	.89	.67	.220
159F-6-4	3/8	1/4	5/8-18	.89	.86	.282
259F-6-4	3/8	1/4	5/8-18	.91	.86	.282
159F-6-6	3/8	3/8	5/8-18	.91	.93	.282
259F-6-6	3/8	3/8	5/8-18	.91	.93	.282
159F-8-4*	1/2	1/4	3/4-16	1.06	.95	.314
159F-8-6	1/2	3/8	3/4-16	1.06	.95	.407
259F-8-6	1/2	3/8	3/4-16	1.04	.93	.407
159F-8-8	1/2	1/2	3/4-16	1.12	1.16	.407
159F-10-6*	5/8	3/8	7/8-14	1.13	.95	.407
159F-10-8	5/8	1/2	7/8-14	1.21	1.16	.501
159F-12-8**	3/4	1/2	1-1/16-14	1.28	1.16	.560

+ For these parts the pipe thread through hole is smaller than the through hole on the flare end.

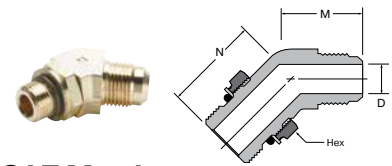

### 45° Flare Elbow to SAE Metric Straight Thread 159F-X-MIX

PART NUMBER	TUBE SIZE	METRIC THREAD	STRAIGHT THREAD TUBE	HEX	M	N	D
159F-8-MII6	1/2	M16 X 1.5	3/4-16	22MM	1.10	1.16	.36
159F-10-MI27	5/8	M27 X 2.0	7/8-14	1 1/4	1.21	1.50	.50

Note: Fluorocarbon o-ring is standard

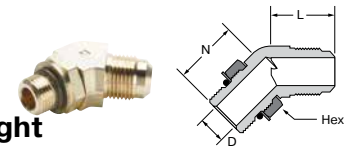

### 45° Flare to SAE Straight Thread 1595F

PART NO.	TUBE SIZE	STRAIGHT THREAD	STRAIGHT THREAD TUBE	HEX	L	N	FLOW DIA. D
1595F-8-8	1/2	3/4-16	3/4-16	7/8	1.00	1.16	.398
1595F-12-8*	3/4	3/4-16	1 1/16-14	7/8	1.41	1.30	.398
1595F-12-12*	3/4	1 1/16-12	1 1/16-14	1 1/4	1.41	1.45	.615

Note: Fluorocarbon o-ring is standard

\* Comes standard with thread protectors

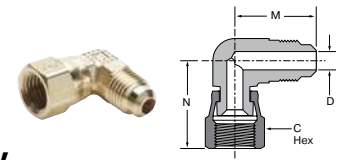

### 90° Swivel Elbow 166FSV

PART NO.	TUBE SIZE	STRAIGHT THREAD	C HEX	M	N	FLOW DIA. D
166FSV-4-4	1/4	7/16-20	9/16	.86	.93	.189
166FSV-6-6	3/8	5/8-18	3/4	1.04	1.12	.282
166FSV-8-8	1/2	3/4-16	7/8	1.20	1.29	.407
166FSV-10-10	5/8	7/8-14	1	1.39	1.50	.501
166FSV-12-12*	3/4	1-1/16-14	1-1/4	1.60	1.83	.626

\* Comes standard with thread protectors

**WARNING** These products can expose you to chemicals including LEAD which is known to the state of California to cause cancer and birth defects or other reproductive harm. For more information go to [www.P65Warnings.ca.gov](http://www.P65Warnings.ca.gov).





Click here for CADs, Product Specifications or to Configure Parts Online

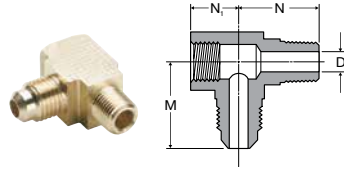

### Adapter Tee 256F

PART NO.	TUBE SIZE	PIPE THREAD	STRAIGHT THREAD	M	N	N1	FLOW DIA. D
256F-4-2	1/4	1/8	7/16-20	.86	.77	.47	.220

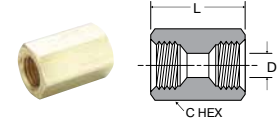

### Flared Union-Female Flare to Female Flare 660FHD

REF. SAE 010107

PART NO.	TUBE SIZE	STRAIGHT THREAD	C HEX	L	FLOW DIA. D
660FHD-4†	1/4	7/16-20	5/8	.98	.251
660FHD-6†	3/8	5/8-18	13/16	1.24	.376
660FHD-8†	1/2	3/4-16	15/16	1.43	.501
660FHD-10†	5/8	7/8-14	1-1/16	1.67	.626

† Should be used with 2GF flare gasket

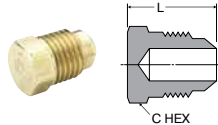

### Flared Seal Plug 639F

REF. SAE 010109

PART NO.	TUBE SIZE	STRAIGHT THREAD	C HEX	L
639F-4	1/4	7/16-20	7/16	.69
639F-5	5/16	1/2-20	1/2	.78
639F-6	3/8	5/8-18	5/8	.88
639F-8	1/2	3/4-16	3/4	1.06
639F-10	5/8	7/8-14	7/8	1.19

\* Comes standard with thread protectors  
 † Should be used with 2GF flare gasket

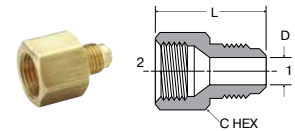

### Male Flare to Female Flare 661FHD

REF. SAE 010105

PART NO.	1 TUBE SIZE	2 TUBE SIZE	1 STRAIGHT THREAD	2 STRAIGHT THREAD	C HEX	L	FLOW DIA. D
661FHD-4-6†	1/4	3/8	7/16-20	5/8-18	13/16	1.20	.189
661FHD-4-8†	1/4	1/2	7/16-20	3/4-16	15/16	1.36	.189
661FHD-6-4†	3/8	1/4	5/8-18	7/16-20	5/8	1.10	.282
661FHD-6-8†	3/8	1/2	5/8-18	3/4-16	15/16	1.42	.282
661FHD-8-6†	1/2	3/8	3/4-16	5/8-18	13/16	1.39	.407
661FHD-8-10†	1/2	5/8	3/4-16	7/8-14	1-1/16	1.67	.407
661FHD-10-8†	5/8	1/2	7/8-14	3/4-16	15/16	1.60	.501
661FHD-10-12*†	5/8	3/4	7/8-14	1-1/16-14	1-5/16	1.95	.501
661FHD-12-10*†	3/4	5/8	1-1/16-14	7/8-14	1-1/16	1.86	.626

\* Comes standard with thread protectors  
 † Should be used with 2GF flare gasket

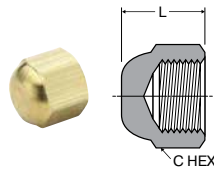

### Cap Nut 640F

REF. SAE 010112

PART NO.	TUBE SIZE	STRAIGHT THREAD	C HEX	L
640F-3†	3/16	3/8-24	1/2	.47
640F-4†	1/4	7/16-20	9/16	.53
640F-5†	5/16	1/2-20	5/8	.62
640F-6†	3/8	5/8-18	3/4	.69
640F-8†	1/2	3/4-16	7/8	.84
640F-10†	5/8	7/8-14	1-1/16	.97

† Should be used with 2GF flare gasket

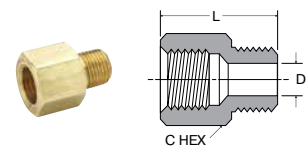

### Female Flare to Male Pipe Thread 664FHD

REF. SAE 010106

PART NO.	TUBE SIZE	PIPE THREAD	STRAIGHT THREAD	C HEX	L	FLOW DIA. D
664FHD-4-2†	1/4	1/8	7/16-20	5/8	.91	.220
664FHD-4-4†	1/4	1/4	7/16-20	5/8	1.01	.252
664FHD-6-4†	3/8	1/4	5/8-18	13/16	1.28	.345
664FHD-8-6†	1/2	3/8	3/4-16	15/16	1.31	.407

† Should be used with 2GF flare gasket

**WARNING** These products can expose you to chemicals including LEAD which is known to the state of California to cause cancer and birth defects or other reproductive harm. For more information go to [www.P65Warnings.ca.gov](http://www.P65Warnings.ca.gov).

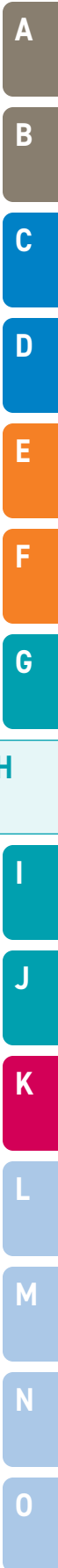

A  
B  
C  
D  
E  
F  
G  
H  
I  
J  
K  
L  
M  
N  
O



# Inverted Flared Fittings

Parker's Inverted Flare Fittings offers a metal-to-metal seal that is internal to the fitting for tighter tube bends. These fittings are listed with UL and meets the functional requirements of SAE J512.

### Product Features:

- All brass construction
- UL listed for flammable liquid and gas
- Meets functional requirements of SAE J512
- Steel nut for economy

### Markets:

- Air Conditioning
- Marine
- Mobile
- Engines

### Applications:

- Refrigerant Lines
- Brake Lines
- Fuel Lines

### Compatible Tubing:

- Copper
- Brass
- Aluminum
- Welded Steel Hydraulic Tubing



### Specifications:

**Temperature Range:** -65° to +250° F (-53.8° to 121.1° C)

### Pressure Range:

TUBE SIZE	PSI	bar	TUBE SIZE	PSI	bar
1/8	2800	193.0	3/8	1000	68.9
3/16	1900	131.0	1/2	750	51.7
1/4	1400	96.5	5/8	650	44.8
5/16	1200	82.7	3/4	550	37.9

### Assembly Instructions

1. Cut tubing squarely and clean to remove burrs
2. Place nut onto tube. Place threaded end of nut toward end of tube.
3. Flare tube end with flaring tool to provide 45° flare
4. On thin wall copper, welded or brazed tubing, use double flare to prevent pinch-off or cracked flares
5. Clamp tube flare between nut and nose of fitting body by screwing nut on finger tight. Tighten nut with a wrench an additional 1/4 to 1/2 turn past finger tight for a metal-to-metal seal.



**WARNING** These products can expose you to chemicals including LEAD which is known to the state of California to cause cancer and birth defects or other reproductive harm. For more information go to [www.P65Warnings.ca.gov](http://www.P65Warnings.ca.gov).



[Click here for CADs, Product Specifications or to Configure Parts Online](#)

### Nut 41IF

REF. SAE 040110

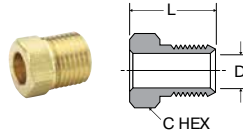

PART NO.	TUBE SIZE	STRAIGHT THREAD	C HEX	L	D
41IF-2	1/8	5/16-28	5/16	.52	.133
41IF-3	3/16	3/8-24	3/8	.56	.196
41IF-4	1/4	7/16-24	7/16	.56	.259
41IF-5	5/16	1/2-20	1/2	.62	.321
41IF-6	3/8	5/8-18	5/8	.66	.384
41IF-8	1/2	3/4-18	3/4	.74	.508
41IF-10	5/8	7/8-18	7/8	.80	.633

### Union 42IFHD

REF. SAE 040101

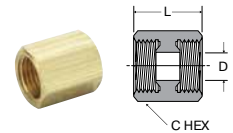

PART NO.	TUBE SIZE	STRAIGHT THREAD	C HEX	L	D
42IFHD-2	1/8	5/16-28	13/32	.60	.078
42IFHD-3	3/16	3/8-24	15/32	.63	.125
42IFHD-4	1/4	7/16-24	17/32	.63	.189
42IFHD-5	5/16	1/2-20	19/32	.71	.220
42IFHD-6	3/8	5/8-18	3/4	.81	.282
42IFHD-8	1/2	3/4-18	29/32	.92	.407

### Steel Nut-Zinc 41IFS

REF. SAE 040110

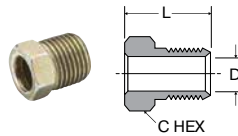

PART NO.	TUBE SIZE	STRAIGHT THREAD	C HEX	L	D
41IFS-3	3/16	3/8-24	3/8	.56	.196

### Female Connector 46IFHD

REF. SAE 040103

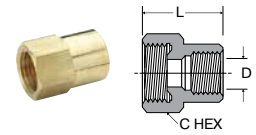

PART NO.	TUBE SIZE	PIPE THREAD	STRAIGHT THREAD	C HEX	L	FLOW DIA. D
46IFHD-3-2	3/16	1/8	3/8-24	1/2	.76	.125
46IFHD-4-2	1/4	1/8	7/16-24	17/32	.78	.189
46IFHD-5-2	5/16	1/8	1/2-20	19/32	.79	.220
46IFHD-6-4	3/8	1/4	5/8-18	3/4	1.04	.282
46IFHD-8-6	1/2	3/8	3/4-18	29/32	1.10	.407

### Piloted Nut 41IFF for Single Flared Tubing

REF. SAE 040110

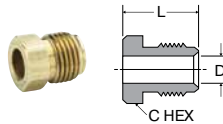

PART NO.	TUBE SIZE	STRAIGHT THREAD	C HEX	L	D
41IFF-2	1/8	5/16-28	5/16	.52	.133
41IFF-3	3/16	3/8-24	3/8	.56	.196
41IFF-4	1/4	7/16-24	7/16	.56	.259
41IFF-5	5/16	1/2-20	1/2	.62	.321
41IFF-6	3/8	5/8-18	5/8	.66	.384
41IFF-8	1/2	3/4-18	3/4	.74	.508

### Male Connector 48IFHD

REF. SAE 040102

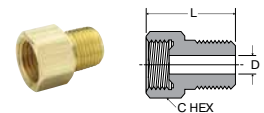

PART NO.	TUBE SIZE	PIPE THREAD	STRAIGHT THREAD	C HEX	L	FLOW DIA. D
48IFHD-2-2	1/8	1/8	5/16-28	13/32	.63	.078
48IFHD-3-2	3/16	1/8	3/8-24	15/32	.70	.125
48IFHD-4-2	1/4	1/8	7/16-24	17/32	.74	.189
48IFHD-4-4	1/4	1/4	7/16-24	9/16	.89	.189
48IFHD-5-2	5/16	1/8	1/2-20	19/32	.79	.220
48IFHD-5-4	5/16	1/4	1/2-20	19/32	.98	.220
48IFHD-6-2	3/8	1/8	5/8-18	3/4	.89	.220
48IFHD-6-4	3/8	1/4	5/8-18	3/4	1.03	.282
48IFHD-6-6	3/8	3/8	5/8-18	3/4	1.03	.282
48IFHD-8-4	1/2	1/4	3/4-18	29/32	1.07	.346
48IFHD-8-6	1/2	3/8	3/4-18	29/32	1.07	.407
48IFHD-8-8	1/2	1/2	3/4-18	29/32	1.26	.407
48IFHD-10-8	5/8	1/2	7/8-18	1-1/16	1.32	.533
48IFHD-12-12	3/4	3/4	1-1/16-16	1 1/4	1.38	.626

**WARNING** These products can expose you to chemicals including LEAD which is known to the state of California to cause cancer and birth defects or other reproductive harm. For more information go to [www.P65Warnings.ca.gov](http://www.P65Warnings.ca.gov).



Click here for CADs, Product Specifications or to Configure Parts Online

- A
- B
- C
- D
- E
- F
- G
- H
- I
- J
- K
- L
- M
- N
- O

### Union Tee 244IFHD

REF. SAE 040401

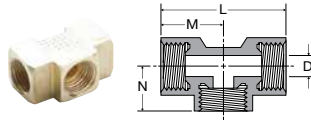

PART NO.	TUBE SIZE	STRAIGHT THREAD	L	M	N	FLOW DIA. D
244IFHD-3	3/16	3/8-24	1.10	.55	.39	.125
244IFHD-4	1/4	7/16-24	1.13	.56	.42	.189
244IFHD-5	5/16	1/2-20	1.26	.63	.45	.220
244IFHD-6	3/8	5/8-18	1.48	.74	.56	.282
244IFHD-8*	1/2	3/4-18	1.76	.88	.67	.407

\*Does not meet SAE or UL.

### Male Branch Tee 245IFHD

REF. SAE 040425

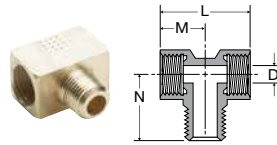

PART NO.	TUBE SIZE	PIPE THREAD	STRAIGHT THREAD	L	M	N	FLOW DIA. D
245IFHD-4-2	1/4	1/8	7/16-24	.85	.43	.64	.189
245IFHD-6-4	3/8	1/4	5/8-18	1.17	.58	.94	.282

### Male Elbow 249IFHD-249IF

REF. SAE 040202

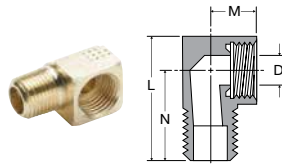

PART NO.	TUBE SIZE	PIPE THREAD	STRAIGHT THREAD	L	M	N	FLOW DIA. D
249IFHD-2-2	1/8	1/8	5/16-28	.79	.27	.58	.078
249IFHD-3-2	3/16	1/8	3/8-24	.85	.27	.61	.125
249IFHD-4-2†	1/4	1/8	7/16-24	.92	.33	.65	.189
249IFHD-4-4	1/4	1/4	7/16-24	1.10	.28	.82	.189
249IFHD-5-4	5/16	1/4	1/2-20	1.16	.45	.86	.220
249IFHD-6-2†	3/8	1/8	5/8-18	1.13	.53	.76	.220
249IF-6-4†	3/8	1/4	5/8-18	1.26	.45	.92	.282
249IFHD-6-4	3/8	1/4	5/8-18	1.32	.53	.95	.282
249IFHD-6-6	3/8	3/8	5/8-18	1.32	.50	.94	.282
249IFHD-8-4*	1/2	1/4	3/4-18	1.48	.59	1.02	.407
249IF-8-6*	1/2	3/8	3/4-18	1.42	.53	.99	.407
249IFHD-8-6†	1/2	3/8	3/4-18	1.48	.59	1.02	.407
249IFHD-8-8	1/2	1/2	3/4-18	1.67	.66	1.22	.407
249IFHD-10-6*	5/8	3/8	7/8-18	1.62	.67	1.09	.531
249IFHD-10-8*	5/8	1/2	7/8-18	1.82	.67	1.29	.533

† Light Duty Series

+ For these parts the pipe thread through hole is smaller than the through hole on the flare end.

### Female Elbow 250IFHD

REF. SAE 040203

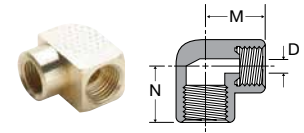

PART NO.	TUBE SIZE	PIPE THREAD	STRAIGHT THREAD	M	N	FLOW DIA. D
250IFHD-3-2	3/16	1/8	3/8-24	.50	.49	.125
250IFHD-4-2	1/4	1/8	7/16-24	.53	.53	.189
250IFHD-5-2	5/16	1/8	1/2-20	.59	.59	.220
250IFHD-6-4	3/8	1/4	5/8-18	.67	.68	.282

### Male Run Tee 251IFHD

REF. SAE 040424

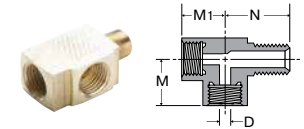

PART NO.	TUBE SIZE	PIPE THREAD	STRAIGHT THREAD	M	M1	N	FLOW DIA. D
251IFHD-3-2	3/16	1/8	3/8-24	.39	.53	.72	.125
251IFHD-5-2	5/16	1/8	1/2-20	.45	.62	.85	.220
251IFHD-6-4	3/8	1/4	5/8-18	.56	.75	1.08	.282

### Female Branch Tee 252IFHD

REF. SAE 040427

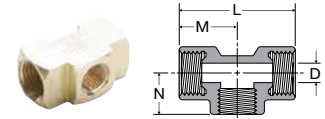

PART NO.	TUBE SIZE	PIPE THREAD	STRAIGHT THREAD	L	M	N	FLOW DIA. D
252IFHD-5-2	5/16	1/8	1/2-20	1.26	.63	.45	.220
252IFHD-6-4	3/8	1/4	5/8-18	1.48	.74	.56	.282

### Union Elbow 255IFHD

PART NO.	TUBE SIZE	STRAIGHT THREAD	M	FLOW DIA. D
255IFHD-4*	1/4	7/16-24	.55	.189

\*Does not meet SAE or UL.

### 45° Elbow 259IFHD

REF. SAE 040302

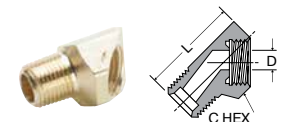

PART NO.	TUBE SIZE	PIPE THREAD	STRAIGHT THREAD	C HEX	L	FLOW DIA. D
259IFHD-3-2	3/16	1/8	3/8-24	17/32	.88	.125
259IFHD-4-2	1/4	1/8	7/16-24	9/16	.94	.189
259IFHD-5-2	5/16	1/8	1/2-20	5/8	1.00	.220
259IFHD-5-4	5/16	1/4	1/2-20	5/8	1.16	.220
259IFHD-6-4*	3/8	1/4	5/8-18	13/16	1.34	.282
259IFHD-8-6	1/2	3/8	3/4-18	7/8	1.44	.407
259IFHD-10-8	5/8	1/2	7/8-18	1-1/16	1.75	.533

\*Does not meet SAE or UL.

**WARNING** These products can expose you to chemicals including LEAD which is known to the state of California to cause cancer and birth defects or other reproductive harm. For more information go to [www.P65Warnings.ca.gov](http://www.P65Warnings.ca.gov).





# Access Valves

Parker's Access Valves are designed to offer convenient, low cost access ports for refrigeration service. Access valves may be installed in any position on either high or low side for quick testing, pressure checking, purging or charging.

## Product Features:

- All brass construction
- 1/4" SAE male flare access ports
- Finger tight quick seal caps
- Access valves with pipe connections have internal ODS solder cups

## Markets:

- Refrigeration
- Air Conditioning

## Applications:

- Pressure Testing
- Purging
- Charging Refrigeration Lines

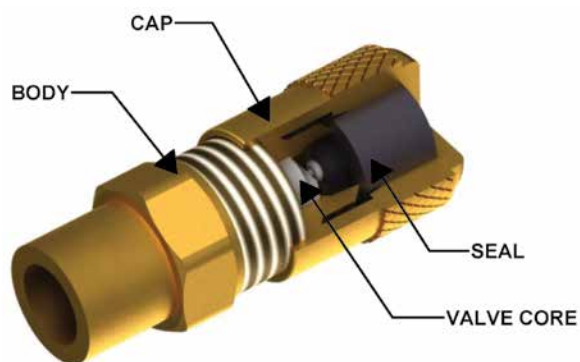

## Specifications:

**Pressure Range** Up to 500 PSI (34.3 bar)

**Temperature Range** -20° to +220° F (-28.8° to +104.4° C)

## Compatible Tubing:

- Copper

**WARNING** These products can expose you to chemicals including LEAD which is known to the state of California to cause cancer and birth defects or other reproductive harm. For more information go to [www.P65Warnings.ca.gov](http://www.P65Warnings.ca.gov).

[Click here for CADs, Product Specifications or to Configure Parts Online](#)

A

B

C

D

E

F

G

H

I

J

K

L

M

N

O

### Extended Copper Tube AVUSE



PART NO.	CONNECTION SIZE
AVUSE-2	1/8" O.D. TUBE
AVUSE-3	3/16" O.D. TUBE
AVUSE-4	1/4" O.D. TUBE
AVUSE-6	3/8" O.D. TUBE
AVUSE-8	1/2" O.D. TUBE

Product comes with valve core loose and should be torqued after brazing to ARI 720 standard.

### Solder Tee AVTS



PART NO.	CONNECTION SIZE
AVTS-4	1/4" O.D. TUBE OR 3/8" SOLDER FITTING/SWAGED TUBE
AVTS-6	3/8" O.D. TUBE OR 1/2" SOLDER FITTING/SWAGED TUBE
AVTS-8	1/2" O.D. TUBE

Product comes with valve core loose and should be torqued after brazing to ARI 720 standard.

### Full Union AVU2



PART NO.	CONNECTION SIZE
AVU2-4	1/4" O.D. FLARE TUBE WITH FORGED FLARE NUT

### Bulkhead Union AVU2BH



PART NO.	CONNECTION SIZE
AVU2BH-4	1/4" BULKHEAD ACCESS X 1/4" SAE WITH FORGED NUT

### Bulkhead Solder Union AVUS3BH



PART NO.	CONNECTION SIZE
AVUS3BH-4	1/4" BULKHEAD ACCESS X 3 WAY ODS

Product comes with valve core loose and should be torqued after brazing to ARI 720 standard.

### Male Connector AVU1



PART NO.	CONNECTION SIZE
AVU1-2	1/8" MALE PIPE OR 1/4" O.D. SOLDER
AVU1-4	1/4" MALE PIPE OR 5/16" O.D. SOLDER

Product comes with valve core loose and should be torqued after brazing to ARI 720 standard.

### Access Valve Assembly AVUIFI



PART NO.	CONNECTION SIZE
AVUIFI-4	7/16-20 SAE STRAIGHT THREAD O-RING PORT

Note: Standard o-ring is neoprene. Consult Brass Products Division for optional o-rings



### Forged Male Elbow AVE1

PART NO.	CONNECTION SIZE
AVE1-2	1/8" MALE PIPE OR 1/4" O.D. SOLDER

Product comes with valve core loose and should be torqued after brazing to ARI 720 standard.

### Forged Male Run Tee AVT3



PART NO.	CONNECTION SIZE
AVT3-2	1/8" MALE PIPE OR 1/4" O.D. SOLDER ON RUN X 1/4" ACCESS ON RUN AND BRANCH WITH ONE CORE AND CAP
AVT3-4	1/4" MALE PIPE OR 5/16" O.D. SOLDER ON RUN X 1/4" ACCESS ON RUN AND BRANCH WITH ONE CORE AND CAP

Product comes with valve core loose and should be torqued after brazing to ARI 720 standard.

### Forged Male Cross AVC1



PART NO.	CONNECTION SIZE
AVC1-4	1/4" MALE PIPE OR 5/16" O.D. SOLDER X 1/4" ACCESS ON ALL FLARE ENDS WITH ONE CORE AND CAP

Product comes with valve core loose and should be torqued after brazing to ARI 720 standard.

### Female Connector AVUR3



PART NO.	CONNECTION SIZE
AVUR3-4	1/4" FEMALE FLARE WITH COPPER GASKET

**WARNING** These products can expose you to chemicals including LEAD which is known to the state of California to cause cancer and birth defects or other reproductive harm. For more information go to [www.P65Warnings.ca.gov](http://www.P65Warnings.ca.gov).



Click here for CADs, Product Specifications or to Configure Parts Online

### 3 Way Solder Connector AVUS3



PART NO.	CONNECTION SIZE
AVUS3-40	FOR 3/16" O.D. TUBE OR 1/4" AND 3/8" SOLDER FITTING/SWAGED TUBE

Product comes with valve core loose and should be torqued after brazing to ARI 720 standard.

### Straight Solder Connector AVUS



PART NO.	CONNECTION SIZE
AVUS-42	1/8" O.D. TUBE OR 1/4" SOLDER FITTING/SWAGED TUBE
AVUS-43	3/16" O.D. TUBE OR 1/4" SOLDER FITTING/SWAGED TUBE
AVUS-44	1/4" O.D. TUBE OR 3/8" SOLDER FITTING/SWAGED TUBE
AVUS-46	3/8" O.D. TUBE OR 1/2" SOLDER FITTING/SWAGED TUBE

Product comes with valve core loose and should be torqued after brazing to ARI 720 standard.

### Swivel Connector AVUS4D



PART NO.	CONNECTION SIZE
AVUS4D-4	1/4" FORGED FEMALE FLARE SWIVEL NUT WITH DEPRESSOR

### Forged Female Run Swivel Tee AVTS4



PART NO.	CONNECTION SIZE
AVTS4-4	1/4" FEMALE FLARE SWIVEL X 1/4" ACCESS ON BOTH RUN AND BRANCH
AVTS4D-4	1/4" FEMALE FLARE SWIVEL ON RUN WITH DEPRESSOR X 1/4" ACCESS ON BOTH RUN AND BRANCH

### Forged Female Branch Tee AVTS6



PART NO.	CONNECTION SIZE
AVTS6-4	1/4" FEMALE FLARE SWIVEL X 1/4" ACCESS ON BOTH ENDS
AVTS6D-4	1/4" FEMALE FLARE SWIVEL ON BRANCH WITH DEPRESSOR X 1/4" ACCESS ON BOTH ENDS

### Quick Seal Caps 640QSF



PART NO.	CONNECTION SIZE
640QSF-4	1/4" SAE SEAL CAP WITH SEAL GASKET
640QSF-6	3/8" SAE SEAL CAP WITH SEAL GASKET

### Quick Seal Cap with Core Remover 640QSFCR



PART NO.	CONNECTION SIZE
640QSFCR-4	1/4" SAE SEAL CAP CORE REMOVER WITH INTERNAL SEAL GASKET

### Core Remover CR



PART NO.	CONNECTION SIZE
CR-001	STANDARD CORE REMOVER

### Valve Cores VC



PART NO.	CONNECTION SIZE
VC-001	REPLACEMENT VALVE CORES FOR ALL 1/4" ACCESS VALVES

### Refrigerant Adapter 88AC



PART NO.	CONNECTION SIZE
88AC-8-2	1/8" MALE PIPE TO SAE J2197 ACME THREADED MALE CONNECTOR

### Refrigerant Adapter 880AC



PART NO.	CONNECTION SIZE
880AC-8-4	1/4" FEMALE SAE FLARE TO SAE J2197 ACME THREADED MALE CONNECTOR

### Refrigerant Adapter 881AC



PART NO.	CONNECTION SIZE
881AC-8-4	1/4" SAE MALE FLARE TO SAE J2197 ACME THREADED FEMALE CONNECTOR

**WARNING** These products can expose you to chemicals including LEAD which is known to the state of California to cause cancer and birth defects or other reproductive harm. For more information go to [www.P65Warnings.ca.gov](http://www.P65Warnings.ca.gov).

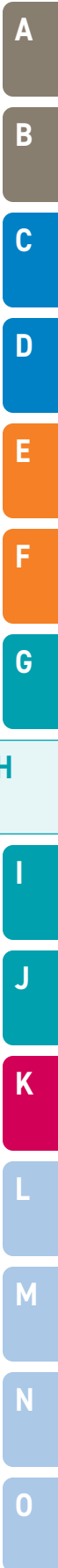



# Industrial Barbed Fittings

Dubl-Barb<sup>®</sup> Fittings

Hose Barb Fittings

Pneumatic Hose Fittings

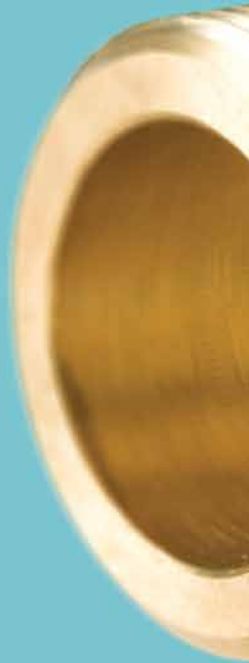



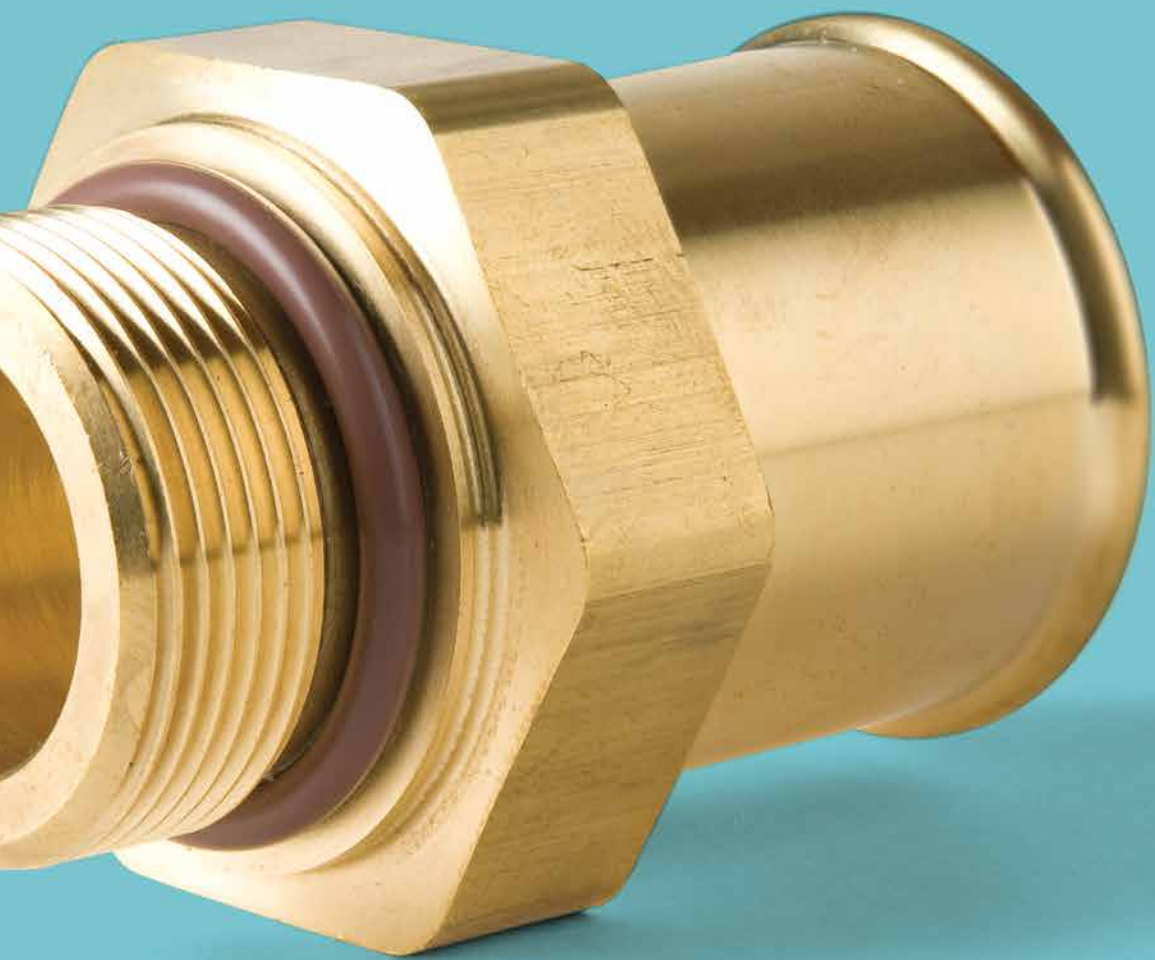







**Threaded Fittings**

<p><b>26</b> Female Connector NPT p. 16</p> 	<p><b>27</b> Male Connector p. 16</p> 	<p><b>28</b> Male Connector NPT p. 17</p> 	<p><b>228</b> Gauge Tee NPT p. 18</p> 	<p><b>229</b> Male Elbow NPT p. 18</p> 	<p><b>230</b> Female Elbow NPT p. 18</p> 	<p><b>231</b> Run Tee NPT p. 18</p> 
<p><b>232</b> Branch Tee NPT p. 18</p> 	<p><b>237</b> Female Tee NPT p. 18</p> 	<p><b>68HB</b> Male Connector NPT p. 110</p> 	<p><b>685HB</b> Male Connector p. 110</p> 	<p><b>68HB-X-MIX</b> Male Connector p. 110</p> 	<p><b>125HB</b> Male Connector NPT p. 110</p> 	<p><b>125HBL</b> Male Connector NPT p. 110</p> 
<p><b>125HBLSV</b> Swivel Connector NPT p. 111</p> 	<p><b>126HBL</b> Female Connector NPT p. 111</p> 	<p><b>127HB</b> Ball-End Adapter NPT p. 111</p> 	<p><b>129HB</b> Male Elbow NPT p. 111</p> 	<p><b>1295HB</b> Male Elbow p. 111</p> 	<p><b>139HB</b> 45° Male Elbow NPT p. 112</p> 	<p><b>1695HB</b> Male Elbow p. 112</p> 
<p><b>169HB-X-MIX</b> Male Elbow p. 112</p> 	<p><b>1725HB</b> Tee p. 112</p> 	<p><b>171HB</b> Run Tee NPT p. 112</p> 	<p><b>179HB</b> 45° Male Elbow NPT p. 112</p> 	<p><b>1795HB</b> 45° Male Elbow p. 113</p> 	<p><b>179HB-X-MIX</b> 45° Male Elbow p. 113</p> 	<p><b>269HB</b> Male Elbow p. 113</p> 
<p><b>279HB</b> 45° Male Elbow p. 113</p> 	<p><b>0123</b> Male Connector BSPT p. 113</p> 	<p><b>0136</b> Metric Hose to BSPT p. 114</p> 	<p><b>0191</b> Metric Hose to BSPP p. 114</p> 	<p><b>0931</b> Metric Hose to BSPP p. 114</p> 		

**Barb to Barb**

<p><b>22</b> Union p. 16</p> 	<p><b>224</b> Union Tee p. 17</p> 	<p><b>225</b> Union Elbow p. 17</p> 	<p><b>122HBL</b> Union p. 110</p> 
--	---	---	---

**Bulkhead Unions**

<p><b>22BH</b> Bulkhead Union p. 16</p> 	<p><b>22CABH</b> Bulkhead Union p. 16</p> 
---	---



**Adapters**

<p><b>22CA</b> Mixed Union p. 16</p> 	<p><b>220</b> Adapter Tee p. 17</p> 	<p><b>238</b> Solder Connector p. 18</p> 
--	---	--

**Swivel**

<p><b>128HBLSV</b> Female Ball-End p. 111</p> 	<p><b>146HBLFSV</b> 45° Female Flare p. 112</p> 
---	---

**Accessories**

<p><b>20</b> Plug p. 16</p> 	<p><b>97HC</b> Clamp p. 113</p> 
---	---

**WARNING** These products can expose you to chemicals including NICKEL or LEAD, which are known to the state of California to cause cancer, and LEAD which is known to cause birth defects or other reproductive harm. For more information go to [www.P65Warnings.ca.gov](http://www.P65Warnings.ca.gov).

A  
B  
C  
D  
E  
F  
G  
H  
I  
J  
K  
L  
M  
N  
O



# Dubl-Barb® Fittings

Parker's Dubl-Barb Fittings are an economical one piece, push-on brass barbed fitting that does not require any type of clamp. These fittings are a quick way to connect polyethylene tubing.

### Product Features:

- Compact
- One piece
- No clamp required
- Good vibration resistance

### Applications:

- Pneumatic Systems
- Climate Control
- Humidifiers
- Filters

### Markets:

- Pneumatic
- Environmental control

### Compatible Tubing:

- Polyethylene



### Specifications:

#### Pressure Range:

TUBE SIZE	PSI	bar	TUBE SIZE	PSI	bar
5/32	150	10.3	3/8	150	10.3
1/4	150	10.3	1/2	100	6.8

#### Temperature Range:

TUBE SIZE	TEMPERATURE IN FAHRENHEIT	TEMPERATURE IN CELSIUS
5/32	-65° to +90° F	-53.8° to +32.2° C
1/4	-65° to +90° F	-53.8° to +32.2° C
3/8	-65° to +90° F	-53.8° to +32.2° C
1/2	-65° to +75° F	-53.8° to +23.8° C

### Assembly Instructions

Cut tube squarely and simply push tube over the two barbs



See Parker Legris Fit Kit on p. I12

**WARNING** These products can expose you to chemicals including LEAD which is known to the state of California to cause cancer and birth defects or other reproductive harm. For more information go to [www.P65Warnings.ca.gov](http://www.P65Warnings.ca.gov).

Click here for CADs, Product Specifications or to Configure Parts Online

- A
- B
- C
- D
- E
- F
- G
- H
- I
- J
- K
- L
- M
- N
- O

### Plug 20

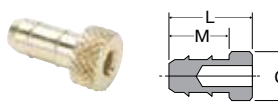

PART NO.	TUBE O.D.	TUBE I.D.	C DIA.	L	M
20-4	1/4	.170	.32	.56	.41
20-6	3/8	.250	.390	.68	.44
20-8	1/2	.377	.577	.81	.56

### Plug Adapter 20

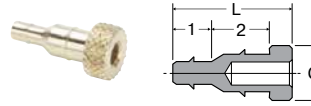

PART NO.	TUBE O.D. 1	TUBE I.D. 1	TUBE O.D. 2	TUBE I.D. 2	C DIA.	L
20-4-5/32	5/32	.096	1/4	.170	.32	.65

### Union 22

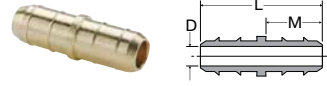

PART NO.	TUBE O.D.	TUBE I.D.	L	M	FLOW DIA. D
22-5/32	5/32X5/32	.096X.096	.59	.28	.062
22-4	1/4X1/4	.170X.170	.84	.41	.120
22-6	3/8X3/8	.250X.250	.94	.44	.187
22-8	1/2X1/2	.375X.375	1.19	.56	.312

### Union Reducer 22

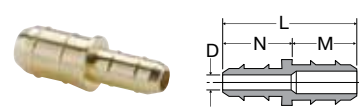

PART NO.	TUBE O.D.	TUBE I.D.	L	M	N	FLOW DIA. D
22-4-5/32	1/4X5/32	.170X.096	.72	.41	.28	.062
22-4-6	1/4X3/8	.170X.250	.88	.44	.41	.120
22-4-8	1/4X1/2	.170X.375	1.06	.56	.41	.120
22-6-8	3/8X1/2	.250X.375	1.06	.56	.44	.187

### Bulkhead Union 22BH

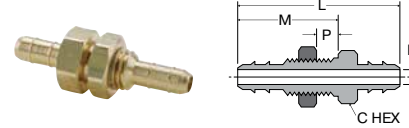

PART NO.	TUBE O.D.	TUBE I.D.	ST. THD.	C HEX	P MAX.	L	M	FLOW DIA. D	BLKHD HOLE DIA.
22BH-4-4	1/4	.170	5/16-24	7/16	.219	1.38	.78	.120	5/16
22BH-6-6	3/8	.250	3/8-24	7/16	.375	1.63	1.00	.187	3/8

### Union 22CA

Tube to Compress-Align

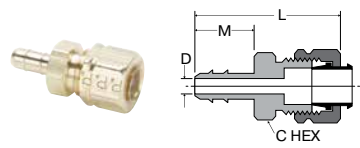

PART NO.	TUBE O.D.	TUBE I.D.	CA TUBE	C HEX	L	M	FLOW DIA. D
22CA-4-4	1/4	.170	1/4	7/16	1.15	.41	.120

### Bulkhead Union 22CABH

Tube to Compress-Align

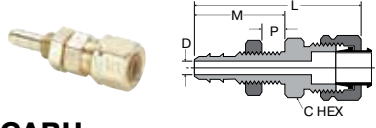

PART NO.	TUBE O.D.	TUBE I.D.	CA TUBE	ST. THD.	C HEX	P MAX	L	M	FLW DIA. D	BKHD HOLE DIA.
22CABH-4-4	1/4	.170	1/4	5/16-24	7/16	.219	1.53	.78	.120	5/16
22CABH-6-6	3/8	.250	3/8	3/8-24	9/16	.375	1.87	1.00	.187	3/8

### Female Connector 26

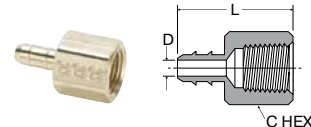

PART NO.	TUBE O.D.	TUBE I.D.	PIPE THREAD	C HEX	L	FLOW DIA. D
26-5/32-2	5/32	.096	1/8	1/2	.79	.062
26-4-2	1/4	.170	1/8	1/2	.91	.120
26-6-2	3/8	.250	1/8	1/2	.93	.187
26-6-4	3/8	.250	1/4	11/16	1.06	.187

### Male Connector 27



PART NO.	TUBE O.D.	TUBE I.D.	STRAIGHT THREAD	C HEX	L	FLOW DIA. D
27-1*	1/8	.062	10-32	1/4	.61	.052
27-2*	1/4	.125	10-32	1/4	.74	.093

\*For vinyl tubing only.

**WARNING** These products can expose you to chemicals including LEAD which is known to the state of California to cause cancer and birth defects or other reproductive harm. For more information go to [www.P65Warnings.ca.gov](http://www.P65Warnings.ca.gov).

Click here for CADs, Product Specifications or to Configure Parts Online

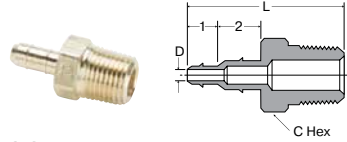

### Barb-to-Pipe Adapter 28

PART NO.	TUBE O.D. 1	TUBE I.D. 1	TUBE O.D. 2	TUBE I.D. 2	PIPE THD.	C HEX	L	FLOW DIA. D
28-4-5/32-2	5/32	.096	1/4	.170	1/8	7/16	1.07	.062

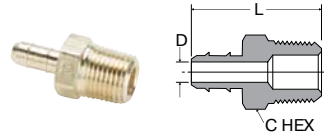

### Male Connector 28

PART NO.	TUBE O.D.	TUBE I.D.	PIPE THREAD	C HEX	L	FLOW DIA. D
28-5/32-2	5/32	.096	1/8	7/16	.84	.062
28-4-1	1/4	.170	1/16	3/8	.93	.120
28-4-2	1/4	.170	1/8	7/16	.97	.120
28-4-4	1/4	.170	1/4	9/16	1.09	.120
28-4-10X32*	1/4	.170	10-32	1/4	.71	.093
28-6-2	3/8	.250	1/8	7/16	1.00	.187
28-6-4	3/8	.250	1/4	9/16	1.13	.187
28-8-4	1/2	.375	1/4	9/16	1.25	.312
28-8-6	1/2	.375	3/8	11/16	1.28	.312
28-8-8	1/2	.375	1/2	7/8	1.44	.312

\*Straight thread

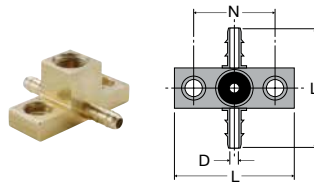

### Adapter Tee 220

PART NO.	TUBE O.D.	TUBE I.D.	PIPE THREAD	L	N	FLOW DIA. D
220-4-2	1/4	.170	1/8	1.50	1.00	.120

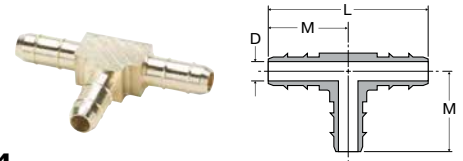

### Union Tee 224

PART NO.	TUBE O.D.	TUBE I.D.	L	M	FLOW DIA. D
224-5/32	5/32	.096	1.00	.50	.062
224-4	1/4	.170	1.25	.63	.120
224-6	3/8	.250	1.38	.69	.187
224-8	1/2	.375	1.63	.81	.312

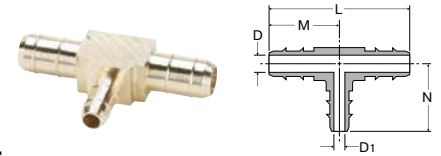

### Union Tee 224 Combination Sizes

PART NO.	TUBE O.D.	TUBE I.D.	L	M	N	FLOW DIA. D	FLOW DIA. D1
224-4-4-5/32	1/4X5/32	.170X.096	1.25	.63	.50	.120	.062
224-6-6-5/32	3/8X5/32	.250X.096	1.38	.69	.50	.187	.062
224-6-6-4	3/8X1/4	.250X.170	1.38	.69	.62	.187	.120
224-8-8-4	1/2X1/4	.375X.170	1.62	.81	.65	.312	.120
224-8-8-6	1/2X3/8	.375X.250	1.62	.81	.69	.312	.187

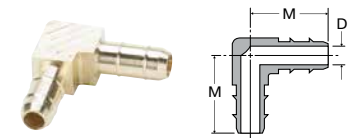

### Union Elbow 225

PART NO.	TUBE O.D.	TUBE I.D.	M	FLOW DIA. D
225-5/32	5/32	.096	.50	.062
225-4-4	1/4	.170	.63	.120
225-6-6	3/8	.250	.69	.187
225-8-8	1/2	.375	.81	.312

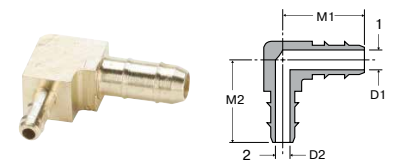

### Union Elbow 225 Combination Size

PART NO.	TUBE O.D. 1	TUBE O.D. 2	TUBE I.D. 1	TUBE I.D. 2	M1	M2	FLOW DIA. D1	FLOW DIA. D2
225-4-5/32	1/4	5/32	.170	.096	.63	.50	.120	.062

**WARNING** These products can expose you to chemicals including LEAD which is known to the state of California to cause cancer and birth defects or other reproductive harm. For more information go to [www.P65Warnings.ca.gov](http://www.P65Warnings.ca.gov).



- A
- B
- C
- D
- E
- F
- G
- H
- I
- J
- K
- L
- M
- N
- O

[Click here for CADs, Product Specifications or to Configure Parts Online](#)

- A
- B
- C
- D
- E
- F
- G
- H
- I
- J
- K
- L
- M
- N
- O

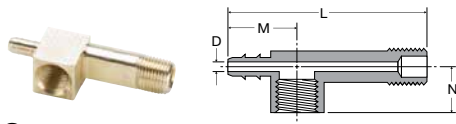

**Gauge Tee 228**

PART NO.	TUBE O.D.	TUBE I.D.	PIPE THREAD	L	M	N	FLOW DIA. D
228-4-2	1/4	.170	1/8	1.91	.66	.44	.120

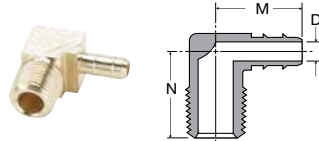

**Male Elbow 229**

PART NO.	TUBE O.D.	TUBE I.D.	PIPE THREAD	M	N	FLOW DIA. D
229-5/32-2	5/32	.096	1/8	.56	.63	.062
229-4-1	1/4	.170	1/16	.62	.60	.120
229-4-2	1/4	.170	1/8	.69	.63	.120
229-4-4	1/4	.170	1/4	.72	.72	.120
229-6-2	3/8	.250	1/8	.69	.69	.187
229-6-4	3/8	.250	1/4	.75	.75	.187
229-8-4	1/2	.375	1/4	.94	.74	.312
229-8-6	1/2	.375	3/8	.94	.81	.312

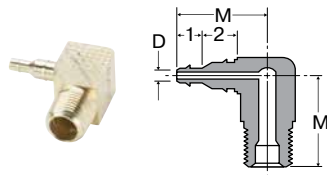

**90° Elbow Barb Adapter 229**

PART NO.	TUBE O.D. 1	TUBE I.D. 1	TUBE O.D. 2	TUBE I.D. 2	PIPE THREAD	M	FLOW DIA. D
229-4-5/32-2	5/32	.096	1/4	.170	1/8	.78	.062

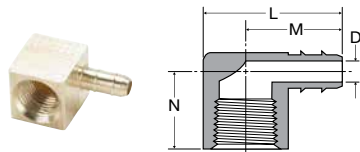

**Female Elbow 230**

PART NO.	TUBE O.D.	TUBE I.D.	PIPE THREAD	L	M	N	FLOW DIA. D
230-4-2	1/4	.170	1/8	.91	.66	.44	.120
230-6-4	3/8	.250	1/4	1.12	.78	.63	.187

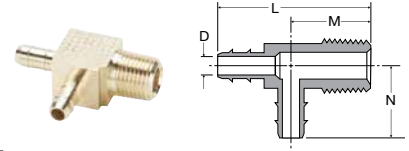

**Male Run Tee 231**

PART NO.	TUBE O.D.	TUBE I.D.	PIPE THREAD	L	M	N	FLOW DIA. D
231-4-2	1/4	.170	1/8	1.28	.66	.69	.120
231-6-2	3/8	.250	1/8	1.38	.69	.69	.187
231-6-4	3/8	.250	1/4	1.44	.75	.75	.187

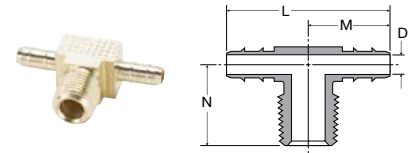

**Male Branch Tee 232**

PART NO.	TUBE O.D.	TUBE I.D.	PIPE THREAD	L	M	N	FLOW DIA. D
232-4-1	1/4	.170	1/16	1.33	.66	.65	.120
232-4-2	1/4	.170	1/8	1.38	.69	.66	.120
232-6-2	3/8	.250	1/8	1.38	.69	.69	.187
232-6-4	3/8	.250	1/4	1.50	.75	.75	.187

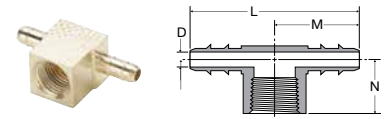

**Female Branch Tee 237**

PART NO.	TUBE O.D.	TUBE I.D.	PIPE THREAD	L	M	N	FLOW DIA. D
237-5/32-2	5/32	.096	1/8	1.06	.53	.44	.062
237-4-2	1/4	.170	1/8	1.34	.67	.49	.120

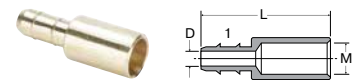

**Solder Connector 238**

PART NO.	TUBE O.D. 1	TUBE I.D. 1	L	M	FLOW DIA. D
238-4-4	1/4	.170	.91	.25	.120

**WARNING** These products can expose you to chemicals including LEAD which is known to the state of California to cause cancer and birth defects or other reproductive harm. For more information go to [www.P65Warnings.ca.gov](http://www.P65Warnings.ca.gov).



# Hose Barb Fittings

Parker's Hose Barb Fittings are an economical choice for general purpose fluid handling and pneumatics. Manufactured in both regular hose barb and beaded hose barb styles. Fittings are intended for use with 97HC hose clamps, similar type clamp or a crimped ferrule.

## Product Features:

- All brass construction
- Fluorocarbon O-rings
- NPTF, SAE straight thread, metric thread ends
- Reusable
- Clamp required

## Compatible Tubing:

- Rubber Hose
- GPH Hose

## Markets:

- Industrial
- Construction
- Heavy duty truck
- Mobile

## Applications:

- Air Lines
- Water Line
- Cooling Lines

## Specifications:

**Pressure Range** Up to 150 PSI (10.3 bar)

**Temperature Range** -40° to +160° F (-40° to +71.1° C)

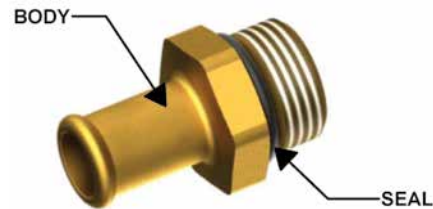

## Assembly Instructions

1. Cut hose cleanly and squarely to length.
2. Slide clamp on hose.
3. Lubricate hose. Push hose on fitting until bottomed against stop ring or hex.
4. Position hose clamp as shown and secure with a screwdriver or wrench. Maintain "A" dimension for proper clamp positioning.



HOSE SIZE	HOSE CLAMP	A
3/16	97 HC-3	1/4
1/4	97 HC-3	1/4
5/16	97 HC-6	1/4
3/8	97 HC-6	1/8
1/2	97 HC-8	1/8
5/8	97 HC-12	1/8
3/4	97 HC-12	1/8

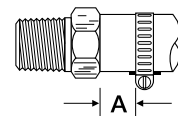

**WARNING** These products can expose you to chemicals including NICKEL or LEAD, which are known to the state of California to cause cancer, and LEAD which is known to cause birth defects or other reproductive harm. For more information go to [www.P65Warnings.ca.gov](http://www.P65Warnings.ca.gov).



Click here for CADs, Product Specifications or to Configure Parts Online

- A
- B
- C
- D
- E
- F
- G
- H
- I
- J
- K
- L
- M
- N
- O

### Beaded Hose Barb to Male Pipe 68HB

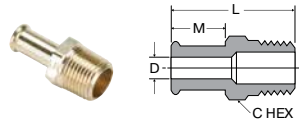

PART NO.	I.D. HOSE SIZE	PIPE THREAD	C HEX	L	M	FLOW DIA. D
68HB-6-6	3/8	3/8	11/16	1.53	.78	.281
68HB-8-4	1/2	1/4	5/8	1.56	.78	.375
68HB-8-6	1/2	3/8	11/16	1.53	.78	.406
68HB-8-8	1/2	1/2	7/8	1.84	.78	.406
68HB-10-6	5/8	3/8	3/4	1.62	.88	.501
68HB-10-8	5/8	1/2	7/8	1.92	.88	.501
68HB-12-8	3/4	1/2	7/8	1.98	.88	.564
68HB-12-12	3/4	3/4	1 1/16	2.04	.97	.625
68HB-16-12	1	3/4	1 1/8	2.12	1.00	.750
68HB-16-16	1	1	1.38	2.31	1.00	.812

### Beaded Hose Barb to SAE Straight Thread 685HB

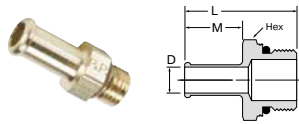

PART NO.	I.D. HOSE SIZE	STRAIGHT THREAD	C HEX	L	M	FLOW DIA. D
685HB-4-4	1/4	7/16-20	9/16	1.40	.78	.18
685HB-6-4	3/8	7/16-20	9/16	1.39	.78	.18
685HB-8-8	1/2	3/4-16	7/8	1.48	.78	.40
685HB-10-8	5/8	3/4-16	7/8	1.56	.78	.40
685HB-12-8	3/4	3/4-16	7/8	1.75	.97	.40
685HB-12-12	3/4	1 1/16-12	1 1/4	1.82	.97	.62
685HB-16-8	1	3/4-16	1 1/8	1.79	.97	.40
685HB-16-12	1	1 1/16-12	1 1/4	1.99	.97	.62

Note: Fluorocarbon o-ring is standard

### Hose Barb to Metric Adaptor 68HB-X-MIX

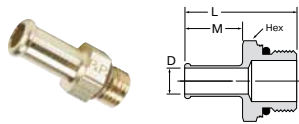

PART NUMBER	I.D. HOSE SIZE	METRIC THREAD	HEX	L	M	D
68HB-6-MI12	3/8	M12 X 1.5	11/16	1.50	.78	.24
68HB-6-MI14	3/8	M14 1.5	3/4	1.51	.78	.29
68HB-8-MI12	1/2	M12 X 1.5	11/16	1.50	.78	.24

Note: Fluorocarbon o-ring is standard

### Hose Mender 122HBL

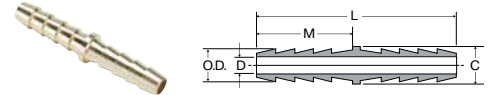

PART NO.	I.D. HOSE SIZE	C DIA.	L	M	O.D.	FLOW DIA. D
122HB-3	3/16	5/16	1.44	.69	.227	.125
122HBL-4	1/4	3/8	2.00	.97	.290	.187
122HBL-5	5/16	7/16	2.00	.97	.353	.250
122HBL-6	3/8	1/2	2.00	.97	.415	.281
122HBL-8	1/2	5/8	2.00	.97	.530	.375
122HBL-12	3/4	7/8	2.00	.97	.790	.562

### Hose Barb to Male Pipe 125HB

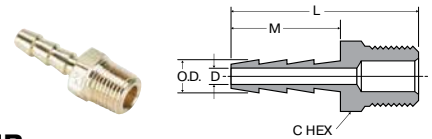

PART NO.	I.D. HOSE SIZE	PIPE THREAD	C HEX	L	M	O.D.	FLOW DIA. D
125HB-2-2	1/8	1/8	7/16	1.07	.50	.185	.093
125HB-3-2	3/16	1/8	7/16	1.25	.69	.227	.125
125HB-3-4	3/16	1/4	9/16	1.44	.69	.227	.125

### Hose Barb to Male Pipe 125HBL

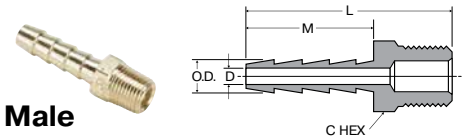

PART NO.	I.D. HOSE SIZE	PIPE THREAD	C HEX	L	M	O.D.	FLOW DIA. D
125HBL-4-2	1/4	1/8	7/16	1.54	.97	.290	.187
125HBL-4-4	1/4	1/4	9/16	1.72	.97	.290	.187
125HBL-4-6	1/4	3/8	11/16	1.77	.97	.290	.187
125HBL-5-2	5/16	1/8	7/16	1.54	.97	.353	.250
125HBL-5-4	5/16	1/4	9/16	1.72	.97	.353	.250
125HBL-5-6	5/16	3/8	11/16	1.77	.97	.353	.250
125HBL-6-2	3/8	1/8	7/16	1.54	.97	.415	.281
125HBL-6-4	3/8	1/4	9/16	1.72	.97	.415	.281
125HBL-6-6	3/8	3/8	11/16	1.77	.97	.415	.281
125HBL-6-8	3/8	1/2	7/8	1.97	.97	.415	.281
125HBL-8-4	1/2	1/4	9/16	1.72	.97	.530	.375
125HBL-8-6	1/2	3/8	11/16	1.77	.97	.530	.375
125HBL-8-8	1/2	1/2	7/8	1.97	.97	.530	.375
125HBL-8-12	1/2	3/4	1-1/16	1.98	.97	.530	.375
125HBL-10-6	5/8	3/8	11/16	1.77	.97	.645	.468
125HBL-10-8	5/8	1/2	7/8	1.97	.97	.645	.468
125HBL-10-12	5/8	3/4	1-1/16	1.98	.97	.645	.468
125HBL-12-8	3/4	1/2	7/8	1.97	.97	.790	.562
125HBL-12-12	3/4	3/4	1-1/16	1.98	.97	.790	.562
125HBL-16-12	1	3/4	1-1/16	2.18	1.17	1.02	.750
125HBL-16-16	1	1	1-3/8	2.36	1.17	1.02	.875

**WARNING** These products can expose you to chemicals including NICKEL or LEAD, which are known to the state of California to cause cancer, and LEAD which is known to cause birth defects or other reproductive harm. For more information go to [www.P65Warnings.ca.gov](http://www.P65Warnings.ca.gov).





Click here for CADs, Product Specifications or to Configure Parts Online

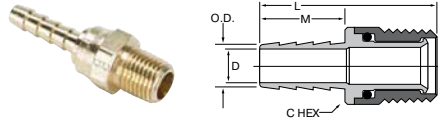

### Male Swivel Hose Barb 125HBLSV

PART NO.	I.D. HOSE SIZE	PIPE THREAD	C HEX	L	M	O.D.	FLOW DIA. D
125HBLSV-4-4	1/4	1/4	9/16	1.73	.97	.290	.187
125HBLSV-6-4	3/8	1/4	9/16	1.73	.97	.415	.212
125HBLSV-6-6	3/8	3/8	11/16	1.80	.97	.415	.280
125HBLSV-8-8	1/2	1/2	7/8	2.01	.97	.530	.375

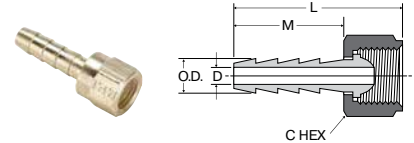

### Hose Barb to Swivel Female Ball-End 128HBLSV

PART NO.	I.D. HOSE SIZE	FEMALE N. P.S.M. THREAD	C HEX	L	M	O.D.	FLOW DIA. D
128HBLSV-4-4	1/4	1/4	5/8	1.50	.97	.290	.187
128HBLSV-5-4	5/16	1/4	5/8	1.50	.97	.353	.250
128HBLSV-6-4	3/8	1/4	5/8	1.63	.97	.415	.250
128HBLSV-6-6	3/8	3/8	3/4	1.50	.97	.415	.281
128HBLSV-8-8	1/2	1/2	29/32	1.52	.97	.530	.375

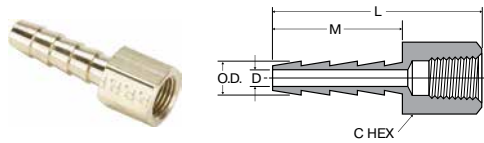

### Hose Barb to Female Pipe 126HBL

PART NO.	I.D. HOSE SIZE	PIPE THREAD	C HEX	L	M	O.D.	FLOW DIA. D
126HBL-4-2	1/4	1/8	1/2	1.47	.97	.290	.187
126HBL-4-4	1/4	1/4	11/16	1.66	.97	.290	.187
126HBL-5-4	5/16	1/4	11/16	1.58	.97	.353	.250
126HBL-6-2	3/8	1/8	1/2	1.47	.97	.415	.281
126HBL-6-4	3/8	1/4	11/16	1.66	.97	.415	.281
126HBL-6-6	3/8	3/8	13/16	1.69	.97	.415	.281
126HBL-8-6	1/2	3/8	13/16	1.69	.97	.530	.375
126HBL-8-8	1/2	1/2	1	1.73	.97	.530	.375
126HBL-12-12	3/4	3/4	1-1/4	1.92	.97	.790	.562

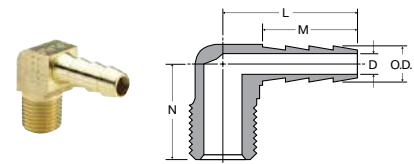

### Hose Barb 90° Elbow to Male Pipe 129HB

PART NO.	I.D. HOSE SIZE	PIPE THREAD	L	M	N	O.D.	FLOW DIA. D
129HB-3-2	3/16	1/8	.97	.69	.66	.227	.173
129HB-4-2	1/4	1/8	1.04	.76	.66	.290	.187
129HB-4-4	1/4	1/4	1.06	.76	.82	.290	.187
129HB-4-6	1/4	3/8	1.19	.76	.84	.290	.187
129HB-5-2	5/16	1/8	1.06	.76	.66	.353	.234
129HB-5-4	5/16	1/4	1.12	.76	.84	.353	.234
129HB-5-6	5/16	3/8	1.19	.76	.84	.353	.234
129HB-6-2	3/8	1/8	1.32	.97	.75	.415	.219
129HB-6-4	3/8	1/4	1.32	.97	.94	.415	.281
129HB-6-6	3/8	3/8	1.50	.97	1.06	.415	.281
129HB-6-8	3/8	1/2	1.52	.97	1.25	.415	.281
129HB-8-4	1/2	1/4	1.53	.97	1.06	.530	.375
129HB-8-6	1/2	3/8	1.53	.97	1.06	.530	.375
129HB-8-8	1/2	1/2	1.53	.97	1.25	.530	.375
129HB-12-12	3/4	3/4	1.33	.79	1.27	.790	.562

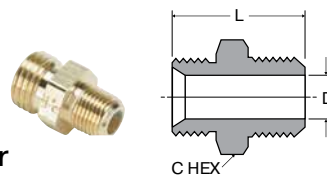

### Ball-End Joint Adapter to Male Pipe 127HB

For use with 128HBLSV

PART NO.	MALE N. P.S.M. THREAD	MALE N. P.T. THREAD	C HEX	L	FLOW DIA. D
127HB-4-2	1/4	1/8	9/16	.91	.219
127HB-4-4	1/4	1/4	9/16	1.10	.281
127HB-6-4	3/8	1/4	11/16	1.10	.312
127HB-6-6	3/8	3/8	11/16	1.15	.406
127HB-8-6	1/2	3/8	7/8	1.25	.406
127HB-8-8	1/2	1/2	7/8	1.50	.531

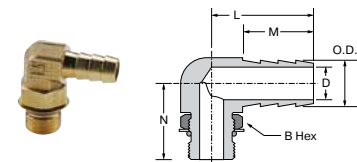

### Hose Barb Elbow to SAE Straight Thread 1295HB

PART NO.	I.D. HOSE SIZE	STRAIGHT THREAD	B HEX	L	M	N	O.D.	FLOW DIA. D
1295HB-6-6	3/8	9/16-18	11/16	1.10	.76	1.10	.42	.280

Note: Fluorocarbon o-ring is standard

**WARNING** These products can expose you to chemicals including NICKEL or LEAD, which are known to the state of California to cause cancer, and LEAD which is known to cause birth defects or other reproductive harm. For more information go to [www.P65Warnings.ca.gov](http://www.P65Warnings.ca.gov).

- A
- B
- C
- D
- E
- F
- G
- H
- I
- J
- K
- L
- M
- N
- O

Click here for CADs, Product Specifications or to Configure Parts Online

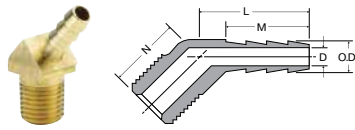

**Hose Barb 45° Elbow to Male Pipe 139HB**

PART NO.	I.D. HOSE SIZE	PIPE THREAD	L	M	N	O.D.	FLOW DIA. D
139HB-4-2	1/4	1/8	.91	.76	.68	.290	.187
139HB-4-4	1/4	1/4	1.00	.76	.68	.290	.187
139HB-6-4	3/8	1/4	1.00	.76	.68	.415	.281

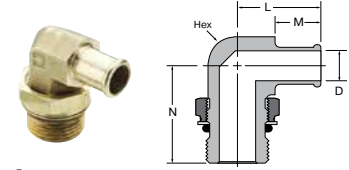

**Beaded Elbow to Metric Adaptor 169HB-X-MIX**

PART NUMBER	HOSE SIZE	METRIC THREAD	HEX	L	M	N	D
169HB-10-MI27	5/8	M27 X 2.0	7/8	1.41	.78	1.63	.50
169HB-16-MI27	1	M27 X 2.0	1	1.67	.97	1.68	.71
169HB-16-MI33	1	M33 X 2.0	1 5/16	1.75	.97	1.90	.84

Note: Fluorocarbon o-ring is standard

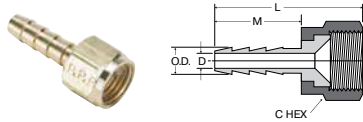

**Hose Barb to Swivel 45° Female Flare 146HBLFSV**

PART NO.	I.D. HOSE SIZE	STRAIGHT THREAD	C HEX	L	M	O.D.	FLOW DIA. D
146HBLFSV-4-4	1/4	7/16-20	9/16	1.55	.97	.290	.187
146HBLFSV-4-6	1/4	5/8-18	3/4	1.72	.97	.290	.187
146HBLFSV-6-6	3/8	5/8-18	3/4	1.72	.97	.415	.281

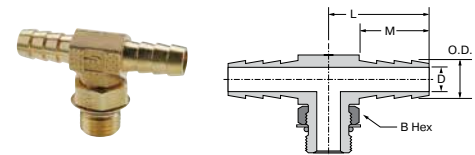

**Hose Barb Tee to SAE Straight Thread 1725HB**

PART NO.	I.D. HOSE SIZE	STRAIGHT THREAD	B HEX	L	M	O.D.	FLOW DIA. D
1725HB-6-6	3/8	9/16-18	11/16	1.10	.76	.420	.280

Note: Fluorocarbon o-ring is standard

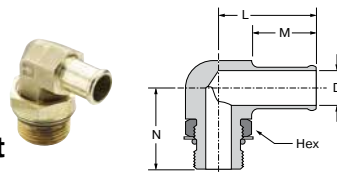

**Beaded Hose Barb Elbow to SAE Straight Thread 1695HB**

PART NUMBER	HOSE SIZE	STRAIGHT THREAD	HEX	L	M	N	D
1695HB-6-4	3/8	7/16-20	9/16	1.09	.78	1.10	.18
1695HB-8-6	1/2	9/16-18	9/16	1.10	.78	1.11	.30
1695HB-8-8	1/2	3/4-16	7/8	1.28	.78	1.42	.40
1695HB-10-8	5/8	3/4-16	7/8	1.47	.88	1.47	.40
1695HB-10-10	5/8	7/8-14	1	1.41	.88	1.60	.50
1695HB-12-8	3/4	3/4-16	7/8	1.47	.97	1.47	.40
1695HB-12-10	3/4	7/8-14	1	1.60	.97	1.62	.50
1695HB-12-12	3/4	1 1/16-12	1	1.60	.97	1.64	.62
1695HB-16-12	1	1 1/16-12	1 1/4	1.60	.97	1.75	.60

Note: Fluorocarbon o-ring is standard

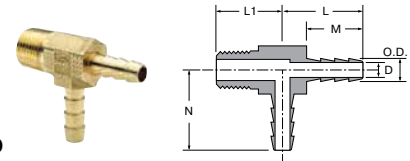

**Hose Barb Tee to Male Pipe 171HB**

PART NO.	I.D. HOSE SIZE	PIPE THREAD	L	L1	M	N	O.D.	FLOW DIA. D
171HB-4-4	1/4	1/4	1.10	.85	.76	1.10	.290	.187

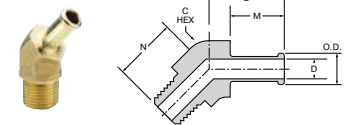

**Beaded Hose Barb 45° Elbow Tube to Male Pipe 179HB**

PART NO.	I.D. HOSE SIZE	NPTF THREAD	C HEX	L	M	N	O.D.	FLOW DIA. D
179HB-6-4	3/8	1/4-18	.75	1.09	.78	.93	.45	.28
179HB-6-6	3/8	3/8-18	.75	1.09	.78	.93	.45	.28
179HB-10-8	5/8	1/2-14	.81	1.19	.78	1.13	.70	.50
179HB-12-8	3/4	1/2-14	.81	1.19	.78	1.13	.83	.56

**WARNING** These products can expose you to chemicals including NICKEL or LEAD, which are known to the state of California to cause cancer, and LEAD which is known to cause birth defects or other reproductive harm. For more information go to [www.P65Warnings.ca.gov](http://www.P65Warnings.ca.gov).



Click here for CADs, Product Specifications or to Configure Parts Online

**Beaded Hose Barb 45° Elbow Tube to Straight Thread 1795HB**

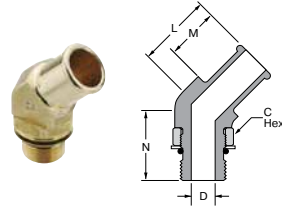

PART NO.	I.D. HOSE SIZE	STRAIGHT THREAD	C HEX	L	M	N	FLOW DIA. D
1795HB-8-8	1/2	3/4-16	7/8	1.12	.78	1.16	.400
1795HB-10-8	5/8	3/4-16	7/8	1.22	.88	1.16	.398
1795HB-12-8	3/4	3/4-16	7/8	1.22	.88	1.16	.398
1795HB-12-12	3/4	1 1/16-12	1 1/4	1.35	.97	1.65	.620
1795HB-16-12	1	1 1/16-12	1 1/4	1.38	.97	1.47	.620

Note: Fluorocarbon o-ring is standard

**Stainless Steel Worm Drive Clamp 97HC**

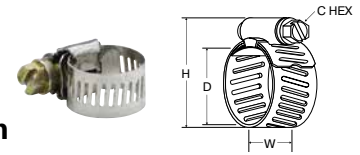

PART NO.	D MAX.	D MIN.	C HEX	H MAX.	W
97HC-3	.62	.25	.25	1.00	.31
97HC-6	.87	.38	.31	1.40	.50
97HC-8	1.00	.44	.31	1.53	.50
97HC-12	1.25	.50	.31	1.80	.50

**Beaded Hose Barb 45° Elbow to Metric Thread 179HB-X-MIX**

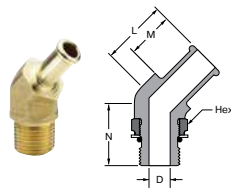

PART NUMBER	HOSE SIZE	METRIC THREAD	HEX	L	M	N	D
179HB-12-MI18	3/4	M18 X 1.5	13/16	1.15	.78	1.16	.44
179HB-16-MI27	1	M27 X 2.0	1 1/16	1.51	.97	1.71	.71

Note: Fluorocarbon o-ring is standard

**Beaded Hose Barb 90° Elbow Tube to Male Pipe 269HB**

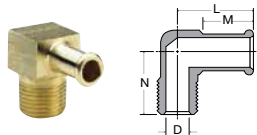

PART NO.	I.D. HOSE SIZE	PIPE THREAD	L	M	N	FLOW DIA. D
269HB-6-6	3/8	3/8	1.19	.78	.88	.281
269HB-8-4	1/2	1/4	1.16	.78	.99	.310
269HB-8-6	1/2	3/8	1.16	.78	1.08	.406
269HB-8-8	1/2	1/2	1.28	.78	1.25	.406
269HB-10-4	5/8	1/4	1.13	.78	.99	.312
269HB-10-6	5/8	3/8	1.16	.78	.99	.406
269HB-10-8	5/8	1/2	1.28	.78	1.25	.501
269HB-12-8	3/4	1/2	1.28	.78	1.25	.563
269HB-12-12	3/4	3/4	1.33	.78	1.27	.625

**Beaded Hose Barb 45° Elbow Tube to Male Pipe 279HB**

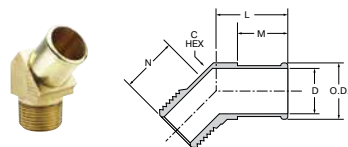

PART NO.	I.D. HOSE SIZE	NPTF THREAD	C HEX	L	M	N	O.D.	FLOW DIA. D
279HB-16-12	1	3/4-14	1.12	1.38	.97	1.13	1.06	.720

**0123 Barbed Adapter for Rubber Hose BSPT**

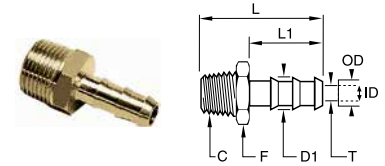

PART NO.	D MM	C BSPT	D1 MM	F MM	L MM	L1 MM	T MIN MM	WT. KG
0123 04 10	4	R1/8	6	10	34	22.5	3.3	.008
0123 06 10	6	R1/8	8	10	34	22.5	5	.009
0123 07 10	7	R1/8	9	10	34	22.5	5	.009
0123 07 13	7	R1/4	9	14	38.5	22.5	6	.018
0123 07 17	7	R3/8	9	17	39	22.5	6	.023
0123 10 10	10	R1/8	12.2	13	34	22.5	5	.014
0123 10 13	10	R1/4	12.2	14	38.5	22.5	7	.021
0123 10 17	10	R3/8	12.2	17	39	22.5	9.5	.023
0123 12 17	12	R3/8	14	17	46	29.5	11	.026
0123 13 13	13	R1/4	15	17	45.5	29.5	7	.027
0123 13 17	13	R3/8	15	17	46	29.5	11	.027
0123 13 21	13	R1/2	15	22	50.5	29.5	12	.047
0123 16 17	16	R3/8	18.5	19	54.5	38	11	.040
0123 16 21	16	R1/2	18.5	22	59	38	14	.056
0123 16 27	16	R3/4	18.5	27	62	38	15	.082
0123 19 17	19	R3/8	21.5	22	54.5	38	11	.046
0123 19 21	19	R1/2	21.5	22	59	38	14	.058
0123 19 27	19	R3/4	21.5	27	62	38	18	.083
0123 25 27	25	R3/4	26.7	27	62	38	18	.083
0123 25 34	25	R1	27	36	65	38	24	.124
0123 32 34	32	R1	34.5	36	70	43	24	.144

**WARNING** These products can expose you to chemicals including NICKEL or LEAD, which are known to the state of California to cause cancer, and LEAD which is known to cause birth defects or other reproductive harm. For more information go to [www.P65Warnings.ca.gov](http://www.P65Warnings.ca.gov).



[Click here for CADs, Product Specifications or to Configure Parts Online](#)

- A
- B
- C
- D
- E
- F
- G
- H
- I
- J
- K
- L
- M
- N
- O

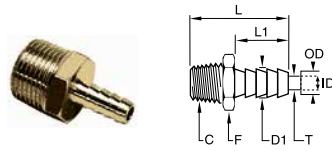

**0136 Barbed Adapter for Nylon Tube BSPT**

PART NO.	D MM	C BSPT	D1 MM	F MM	L MM	L1 MM	T MIN MM	WT. KG
0136 06 10	6	R1/8	6.4	10	26.5	15	4	.007
0136 06 13	6	R1/4	6.4	14	31	15	4	.015
0136 06 17	6	R3/8	6.4	17	31.5	15	4	.020
0136 08 13	8	R1/4	8.4	14	31	15	6	.016
0136 08 17	8	R3/8	8.4	17	31.5	15	6	.020
0136 08 21	8	R1/2	8.4	22	36	15	6	.039
0136 10 13	10	R1/4	10.7	14	36	20	7	.019
0136 10 17	10	R3/8	10.7	17	36.5	20	8	.023
0136 10 21	10	R1/2	10.7	22	41	20	8	.040
0136 12 13	12	R1/4	12.7	14	36	20	7	.019
0136 12 17	12	R3/8	12.7	17	36.5	20	10	.023
0136 12 21	12	R1/2	12.7	22	41	20	10	.042
0136 12 27	12	R3/4	12.7	27	44	20	10	.072
0136 13 17	13	R3/8	13.7	17	36.5	20	11	.023
0136 13 21	13	R1/2	13.7	22	41	20	11	.041
0136 13 27	13	R3/4	13.7	27	44	20	11	.071

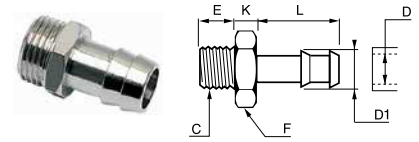

**0931 Nickel Plated Hose to Male BSPP**

PART NO.	D MM	C BSPP	D1 MM	E MM	F MM	K MM	L MM	WT. KG
0931 06 10	6	G1/8	7	6	12	4	20	0.008
0931 06 13	6	G1/4	7	8	14	5	20	0.013
0931 07 10	7	G1/8	8	6	12	4	20	0.009
0931 07 13	7	G1/4	8	8	14	5	20	0.017
0931 07 17	7	G3/8	8	9	19	5	20	0.022
0931 08 10	8	G1/8	9	6	12	4	20	0.009
0931 08 13	8	G1/4	9	8	14	5	20	0.014
0931 08 17	8	G3/8	9	9	19	5	20	0.022
0931 10 13	10	G1/4	12	8	14	5	20	0.016
0931 10 17	10	G3/8	12	9	19	5	20	0.023
0931 10 21	10	G1/2	12	10	22	6	22	0.032
0931 15 17	15	G3/8	17	9	19	6	24	0.030
0931 15 21	15	G1/2	17	10	22	6	24	0.036
0931 18 21	18	G1/2	20	10	22	6	24	0.043

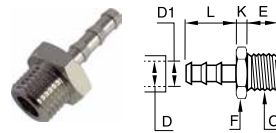

**0191 Nickel Plated Hose to Male BSPP**

PART NO.	D MM	C BSPP	D1 MM	E MM	F MM	K MM	L MM	WT. KG
0191 04 13	4	G1/4	6	9.5	17	5	22.5	.019
0191 07 13	7	G1/4	9	9.5	17	5	22.5	.021
0191 07 21	7	G1/2	9	11	27	7	29.5	.065
0191 10 13	10	G1/4	12.2	9.5	17	5	22.5	.021
0191 10 21	10	G1/2	12.2	11	27	7	29.5	.060
0191 13 13	13	G1/4	15.2	9.5	17	5	22.5	.023
0191 13 21	13	G1/2	15.2	11	27	7	29.5	.058
0191 16 21	16	G1/2	18.5	11	27	7	36.5	.069

**WARNING** These products can expose you to chemicals including NICKEL or LEAD, which are known to the state of California to cause cancer, and LEAD which is known to cause birth defects or other reproductive harm. For more information go to [www.P65Warnings.ca.gov](http://www.P65Warnings.ca.gov).



[Click here for CADs, Product Specifications or to Configure Parts Online](#)



# Pneumatic Hose Fittings

Parker's Pneumatic Hose Fittings are manufactured from heavy duty brass for dependable, leak-free usage.

### Product Features:

- All Brass Construction

### Markets:

- Industrial Pneumatics
- Industrial Automation
- Construction & Carpentry

### Applications:

- Air Hose
- Blow Guns
- Pneumatic Assembly Tools
- Construction & carpentry tools
- Manufacturing air drops

### Specifications:

**Pressure Range** Dependent on hose end connection

**Temperature Range** Dependent on hose end connection

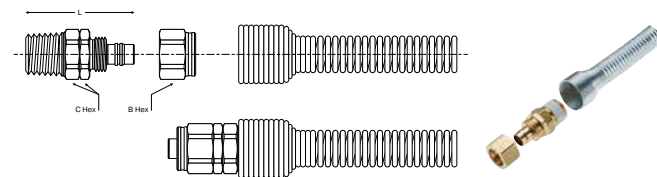
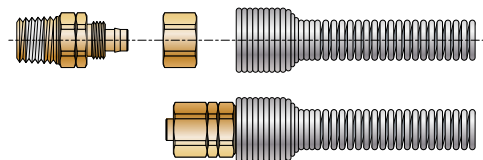

### Field Attachable Fittings (Nylon Hose)

PART NO.	THD SIZE (NPT)	HOSE SIZE (IN)	B HEX (IN)	C HEX (IN)	L (IN)
01200	1/8	1/8	7/16	7/16	1.31
01300	1/4	3/16	9/16	9/16	1.31
01400-XX	1/4	1/4	9/16	9/16	1.37
01500	1/4	5/16	9/16	5/8	1.56
01640	1/4	3/8	9/16	11/16	1.48
01600	3/8	3/8	11/16	11/16	1.53
01700	1/2	1/2	15/16	15/16	1.93
01802*	3/4	3/4	1 1/4	1 1/4	2.98

Includes Nut & Spring Guard

\*Spring Guard Not Required

**WARNING** These products can expose you to chemicals including NICKEL or LEAD, which are known to the state of California to cause cancer, and LEAD which is known to cause birth defects or other reproductive harm. For more information go to [www.P65Warnings.ca.gov](http://www.P65Warnings.ca.gov).





# Industrial Adapters

Pipe Fittings

Metric Adapters

Nickel Plated Metric Adapters

ISO Port Adapters

Garden Hose Fittings



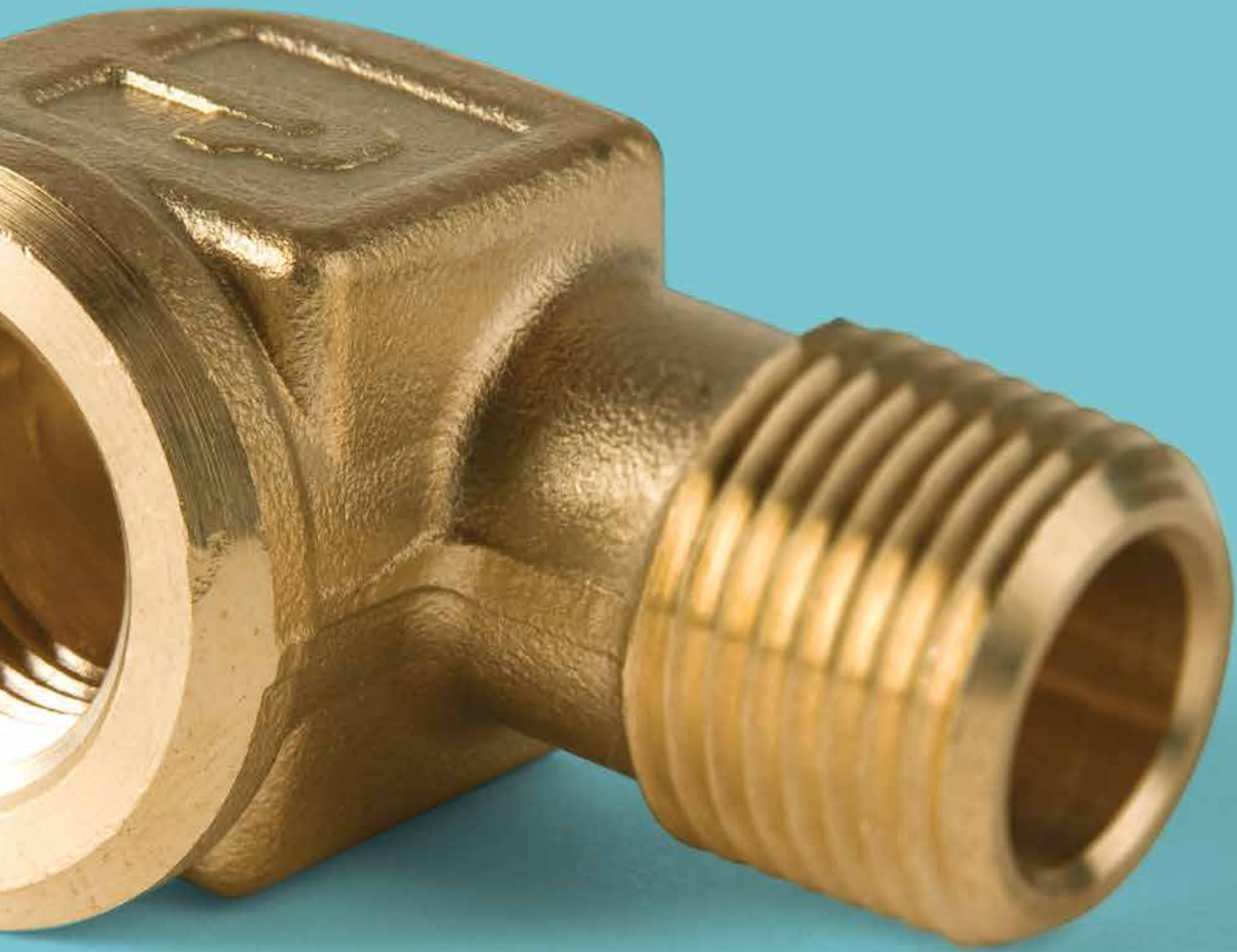

**Male to Male**

**215PN**

Close Nipple  
Pipe to Pipe  
p. J9



**215PNL**

Long Nipple  
Pipe to Pipe  
p. J9



**216P**

Hex Nipple  
Pipe to Pipe  
p. J10



**1204P**

Male Elbow  
Pipe to Pipe  
p. J11



**0152**

Union Elbow  
BSPT to BSPT  
p. J14



**0121**

Hex Nipple  
NPT to BSPT  
p. J15



**0929**

3 Piece Adapter  
BSPT to BSPT  
p. J15



**0914/0922**

Union Elbow  
BSPT to BSPT  
p. J17



**0927**

Union Tee  
BSPT to BSPT  
p. J18



**0900**

Hex Nipple  
BSPT to BSPT  
p. J19



**0901**

Hex Nipple  
BSPP to BSPP  
p. J20



**0192**

Hex Nipple  
BSPT to BSPP  
p. J20



**Male to Female**

**209P**

Bushing  
Pipe to Pipe  
p. J8



**222P**

Adapter  
Pipe to Pipe  
p. J10



**1202P-2202P**

Street Elbow  
Pipe to Pipe  
p. J11



**2224P**

Male Branch Tee  
Pipe to Pipe  
p. J11



**2225P**

Street Tee  
Pipe to Pipe  
p. J11



**2214P**

45° Street Elbow  
Pipe to Pipe  
p. J12



**F3HG**

Adapter - Male  
BSPT to NPT  
p. J14



**0164**

Female BSPP  
NPT to BSPP  
p. J14



**0144**

Street Elbow  
BSPT to BSPP  
p. J14



**0158**

Male Branch Tee  
BSPT to BSPP  
p. J15



**0163**

Bushing  
BSPT to BSPP  
p. J16



**0169**

Adapter  
BSPP to BSPP  
p. J16



**0913/0921**

Street Elbow  
BSPT to BSPP  
p. J17



**0911**

Y Connector  
BSPT to BSPP  
p. J17



**0916/0923**

Male Branch Tee  
BSPT to BSPP  
p. J18



**0917/0924**

Male Run Tee  
BSPT to BSPP  
p. J18



**0928**

Female Branch Tee  
BSPT to BSPP  
p. J18



**0909**

Cross  
BSPT to BSPP  
p. J18



**0903**

Adapter Reducer  
BSPP to BSPP  
p. J18



**0904**

Bushing  
BSPT to BSPP  
p. J19



**0905**

Bushing  
BSPP to BSPP  
p. J19



**0906**

Adapter  
BSPP to BSPP  
p. J19



**0907**

Extended Adapter  
BSPP to BSPP  
p. J19



**WARNING** These products can expose you to chemicals including CARBON BLACK, or LEAD, which are known to the state of California to cause cancer, and LEAD which is known to cause birth defects or other reproductive harm. For more information go to [www.P65Warnings.ca.gov](http://www.P65Warnings.ca.gov).



**Female to Female**

**207ACBH**  
Anchor Coupling  
Pipe to Pipe  
p. J8



**207ACBH-S**  
Sealed Bulkhead  
p. J8



**207P**  
Coupling  
Pipe to Pipe  
p. J8



**208P**  
Reducer Coupling  
Pipe to Pipe  
p. J8



**212P**  
Union  
Pipe to Pipe  
p. J9



**1200P-2200P**  
Union Elbow  
Pipe to Pipe  
p. J10



**1203P-2203P**  
Union Tee  
Pipe to Pipe  
p. J11



**2200PDE**  
Drop-Ear Elbow  
Pipe to Pipe  
p. J12



**1201-2201P**  
45° Female Elbow  
Pipe to Pipe  
p. J12



**2205P**  
Cross  
Pipe to Pipe  
p. J12



**0143**  
Union Elbow  
BSPP to BSPP  
p. J14



**0145**  
Union Tee  
BSPP to BSPP  
p. J14



**0117**  
Bulkhead  
BSPP to BSPP  
p. J15



**0155**  
Coupling  
BSPP to BSPP  
p. J16



**0168**  
Adapter  
BSPP to BSPP  
p. J16



**0912**  
Union Elbow  
BSPP to BSPP  
p. J17



**0910**  
Union Y  
BSPP to BSPP  
p. J17



**0915**  
Union Tee  
BSPP to BSPP  
p. J17



**0908**  
Cross  
BSPP to BSPP  
p. J18



**0920**  
Bulkhead  
BSPP to BSPP  
p. J19



**0902**  
Coupling  
BSPP to BSPP  
p. J20



**Threaded Fittings (ISO Port Adapters)**

**222P-X-MIX**  
Adapter  
p. J14, J24



**48F-X-MIX**  
Male Connector  
p. J24



**149F-X-MIX**  
Male Elbow  
p. J24



**159F-X-MIX**  
45° Male Elbow  
p. J24



**68HB-X-MIX**  
Male Connector  
p. J24



**169HB-X-MIX**  
Male Elbow  
p. J24



**68NTA-X-MIX**  
Male Connector  
p. J24



**179HB-X-MIX**  
45° Male Elbow  
p. J24



**Garden Hose Fittings**

**50GHSV**  
Swivel Connector  
p. J26



**54GH-55GH**  
Hose Barb  
p. J26



**69GH-70GH-71GH**  
Male Pipe  
p. J26



**75GH**  
Connector  
p. J26



**78GH-79GH-80GH-81GH**  
Female Pipe  
p. J26



**82GH-83GH**  
Female Hose  
p. J26



**88GH**  
Swivel Connector  
p. J26



**90GH**  
Swivel Connector  
p. J26



**98GH-99GH**  
Hose to Pipe  
p. J27



**98GHSV-99GHSV**  
Swivel Connector  
p. J27



**101GHSV**  
Swivel Nut  
Connector  
p. J27



**WARNING** These products can expose you to chemicals including CARBON BLACK, or LEAD, which are known to the state of California to cause cancer, and LEAD which is known to cause birth defects or other reproductive harm. For more information go to [www.P65Warnings.ca.gov](http://www.P65Warnings.ca.gov).

A  
B  
C  
D  
E  
F  
G  
H  
I  
J  
K  
L  
M  
N  
O

**Accessories**

**207ACBH-WSHR**

Sealing Washer Kit  
p. J8



**210P**

Lock Nut  
p. J9



**211P**

Square Head Plug  
p. J9



**213P**

Cap  
p. J9



**218P**

Hex Head Plug  
p. J10



**219P**

Countersunk Plug  
p. J10



**220P**

Slotted Head Plug  
p. J10



**0200**

Hex Head Plug  
BSPP, Metric  
p. J20



**0205**

Internal Hex Head  
Plug – NPT, BSPT  
p. J20



**0285**

Internal Hex Head  
Plug – NPT, BSPT  
p. J21



**0206**

Internal Hex Head  
NPT, BSPT  
p. J21



**0138**

Copper Washer  
BSPP, Metric  
p. J21



**0139**

Bi-Material Captive  
Sealing Washer  
BSPP  
p. J21



**0602**

Captive Sealing  
Washer – BSPP, M5  
p. J21



**94GH**

Hose Nut  
p. J26



**95GH**

Hose Nut Reducer  
p. J27



**96GH**

Hose Cap  
p. J27



**901GH**

Washer  
p. J27



**1163-60-BPD**

Coupler  
p. J27



**1163-61-BPD**

Nipple  
p. J27



**WARNING** These products can expose you to chemicals including CARBON BLACK, or LEAD, which are known to the state of California to cause cancer, and LEAD which is known to cause birth defects or other reproductive harm. For more information go to [www.P65Warnings.ca.gov](http://www.P65Warnings.ca.gov).





# Pipe Fittings

Parker's Pipe Fittings meet all functional requirements of SAE J530 and SAE J531. All threads on the pipe fittings are made to dryseal standards.

## Product Features:

- All brass construction
- Meets functional requirements of SAE J530 and SAE J531
- Threads made to dryseal standards
- Both forgings and extrusions available

## Markets:

- Industrial
- Construction
- Heavy duty truck
- Mobile
- Factory/process automation

## Applications:

- Air Lines
- Water Line
- Cooling Lines

## Specifications:

**Pressure Range** Up to 1000 PSI (68.9 bar)

**Temperature Range** -65° to +250° F (-53.9° to +121.1° C)

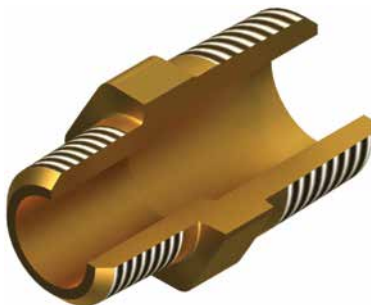

## Assembly Instructions

### Straight Fittings

1. Hand tighten external thread into internal thread
2. Tighten an additional 2 turns with a wrench up to 1/2" male pipe thread.
3. Above 1/2" 1 1/2 to 2 1/2 turns.

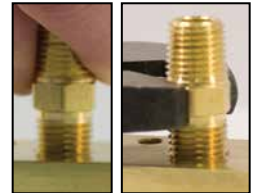

### Elbow or Tee Fittings

1. Hand tighten external thread into internal thread
2. Tighten an additional 1 to 1 1/2 turns with a wrench
3. Tighten fitting, clockwise to align with tubing. (Never counter clockwise)



Note: To minimize the possibility of a leaking threaded joint after assembling Male to female pipe threads, neither end should be backed out (loosened) Once the assembly has been made.

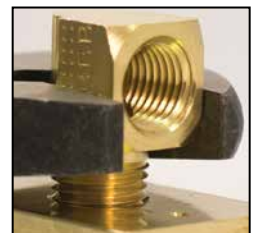

**WARNING** These products can expose you to chemicals including LEAD which is known to the state of California to cause cancer and birth defects or other reproductive harm. For more information go to [www.P65Warnings.ca.gov](http://www.P65Warnings.ca.gov).



A

B

C

D

E

F

G

H

I

J

K

L

M

N

O

Click here for CADs, Product Specifications or to Configure Parts Online

- A
- B
- C
- D
- E
- F
- G
- H
- I
- J
- K
- L
- M
- N
- O

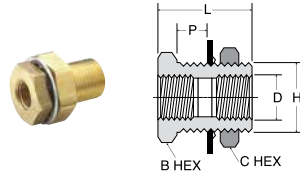

### Bulkhead 207ACBH

PART NO.	FEAMLE PIPE THREAD	STRAIGHT THREAD	MAX. BULK HEAD P	B HEX	C HEX	L	BLKHD HOLE DIA. H	FLOW DIA. D
207ACBH-2	1/8	5/8-18	.89	7/8	15/16	1.50	5/8	.339
207ACBHS-2	1/8	5/8-18	.35	7/8	15/16	.96	5/8	.339
207ACBH-4	1/4	3/4-16	.81	1	1-1/8	1.50	3/4	.441
207ACBHS-4	1/4	3/4-16	.26	1	1	.94	3/4	.441
207ACBH-6	3/8	1-14	.62	1-1/8	1-1/4	1.31	1	.571
207ACBH-8	1/2	1-1/8-14	.75	1-1/4	1-3/8	1.50	1-1/8	.703
207ACBH-12	3/4	1-5/16-12	.65	1-1/2	1-1/2	1.50	1-5/16	.906
207ACBH-16*	1	1-5/8-14	1.00	2	2	1.68	1-5/8	1.140

\*Lock Washer not Available

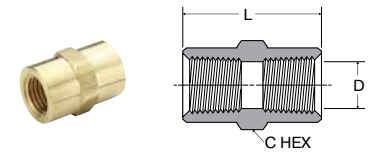

### Coupling 207P

PART NO.	PIPE THREAD	C HEX	L	FLOW DIA. D
207P-2	1/8	9/16	.75	.339
207P-4	1/4	3/4	1.12	.441
207P-6	3/8	7/8	1.12	.571
207P-8	1/2	1-1/16	1.50	.703
207P-12	3/4	1-3/8	1.53	.906

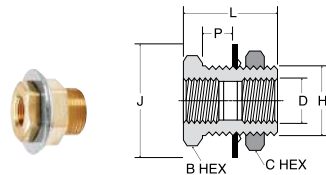

### Sealed Bulkhead 207ACBH-S

PART NO.	FEAMLE PIPE THREAD	STRAIGHT THREAD	MAX. BULK HEAD P	B HEX	C HEX	J	L	BLKHD HOLE DIA. H	FLOW DIA. D
207ACBH-2-S	1/8	5/8-18	.84	7/8	15/16	1.19	1.50	.656	.339
207ACBHS-2-S	1/8	5/8-18	.30	7/8	15/16	1.19	.96	.656	.339
207ACBH-4-S	1/4	3/4-16	.75	1	1-1/8	1.31	1.50	.781	.441
207ACBHS-4-S	1/4	3/4-16	.20	1	1	1.31	.94	.781	.441
207ACBH-6-S	3/8	1-14	.56	1-1/8	1-1/4	1.75	1.31	1.031	.571

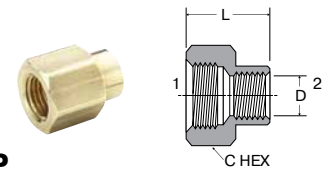

### Reducer Coupling 208P

PART NO.	1 PIPE THREAD	2 PIPE THREAD	C HEX	L	FLOW DIA. D
208P-4-2	1/4	1/8	3/4	.97	.339
208P-6-4	3/8	1/4	7/8	1.16	.441
208P-8-4	1/2	1/4	1-1/16	1.28	.441
208P-8-6	1/2	3/8	1-1/16	1.38	.571
208P-12-6	3/4	3/8	1-3/8	1.32	.571
208P-12-8	3/4	1/2	1-3/8	1.50	.703

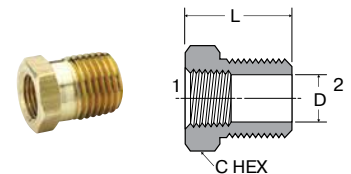

### Bushing 209P

PART NO.	1 PIPE THREAD	2 PIPE THREAD	C HEX	L	FLOW DIA. D
209P-4-2	1/8	1/4	9/16	.75	.339
209P-6-2	1/8	3/8	11/16	.75	.339
209P-6-4	1/4	3/8	3/4	.75	.441
209P-8-2	1/8	1/2	7/8	1.00	.339
209P-8-4	1/4	1/2	7/8	1.00	.441
209P-8-6	3/8	1/2	7/8	1.00	.571
209P-12-2	1/8	3/4	1-1/8	1.00	.339
209P-12-4	1/4	3/4	1-1/8	1.00	.441
209P-12-6	3/8	3/4	1-1/8	1.00	.571
209P-12-8	1/2	3/4	1-1/8	1.00	.703
209P-16-8	1/2	1	1-3/8	1.31	.703
209P-16-12	3/4	1	1-3/8	1.31	.906

### Sealing Washer Kit (10 pcs)



PART NO.	INNER DIA.	OUTER DIA.
207ACBH-WSHR-2	.625	1.19
207ACBH-WSHR-4	.75	1.31
207ACBH-WSHR-6	1.00	1.75

**WARNING** These products can expose you to chemicals including LEAD which is known to the state of California to cause cancer and birth defects or other reproductive harm. For more information go to [www.P65Warnings.ca.gov](http://www.P65Warnings.ca.gov).

Click here for CADs, Product Specifications or to Configure Parts Online

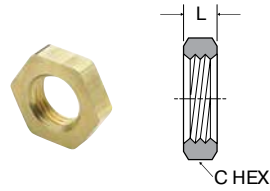

### Lock Nut 210P

PART NO.	PIPE THREAD	C HEX	L
210P-2	1/8 NPSL	11/16	.19
210P-4	1/4 NPSL	7/8	.25
210P-6	3/8 NPSL	1	.25
210P-8	1/2 NPSL	1-1/8	.25

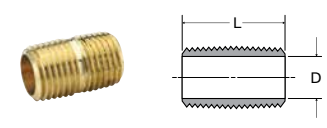

### Close Nipple 215PN

PART NO.	PIPE THREAD	L	FLOW DIA. D
215PN-2	1/8	.75	.281
215PN-4	1/4	.88	.375
215PN-6	3/8	1.00	.500
215PN-8	1/2	1.13	.625
215PN-12	3/4	1.31	.750

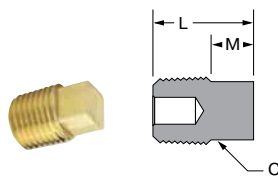

### Square-Head Plug 211P

PART NO.	PIPE THREAD	C	L	M
211P-2	1/8	9/32	.59	.25
211P-4	1/4	3/8	.80	.29
211P-6	3/8	7/16	.83	.32
211P-8	1/2	9/16	1.07	.39
211P-12	3/4	5/8	1.14	.45

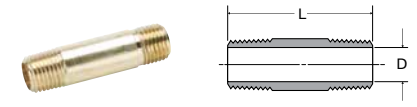

### Long Nipple 215PNL

PART NO.	PIPE THREAD	L	FLOW DIA. D
215PNL-2-15	1/8	1-1/2	.250
215PNL-4-15	1/4	1-1/2	.375
215PNL-6-15	3/8	1-1/2	.500
215PNL-8-15	1/2	1-1/2	.625
215PNL-2-20	1/8	2	.250
215PNL-4-20	1/4	2	.375
215PNL-6-20	3/8	2	.500
215PNL-8-20	1/2	2	.625
215PNL-2-25	1/8	2-1/2	.250
215PNL-4-25	1/4	2-1/2	.375
215PNL-6-25	3/8	2-1/2	.500
215PNL-8-25	1/2	2-1/2	.625
215PNL-2-30	1/8	3	.250
215PNL-4-30	1/4	3	.375
215PNL-6-30	3/8	3	.500
215PNL-8-30	1/2	3	.625
215PNL-2-35	1/8	3-1/2	.250
215PNL-4-35	1/4	3-1/2	.375
215PNL-6-35	3/8	3-1/2	.500
215PNL-8-35	1/2	3-1/2	.625

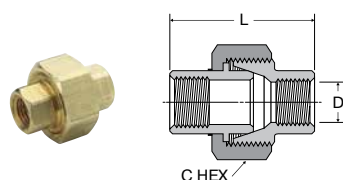

### Union 212P

PART NO.	PIPE THREAD	C HEX	L	D
212P-4	1/4	1-3/16	1.54	.441
212P-6	3/8	1-1/4	1.76	.571

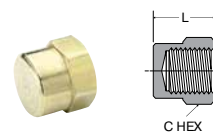

### Cap 213P

PART NO.	PIPE THREAD	C HEX	L
213P-2	1/8	9/16	.50
213P-4	1/4	11/16	.63
213P-6	3/8	13/16	.63
213P-8	1/2	1-1/16	.87
213P-12	3/4	1-1/4	.89

**WARNING** These products can expose you to chemicals including LEAD which is known to the state of California to cause cancer and birth defects or other reproductive harm. For more information go to [www.P65Warnings.ca.gov](http://www.P65Warnings.ca.gov).



[Click here for CADs, Product Specifications or to Configure Parts Online](#)

- A
- B
- C
- D
- E
- F
- G
- H
- I
- J
- K
- L
- M
- N
- O

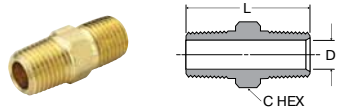

### Hex Nipple 216P

PART NO.	PIPE THREAD	C HEX	L	FLOW DIA. D
216P-2	1/8	7/16	.97	.220
216P-4	1/4	9/16	1.38	.314
216P-6	3/8	11/16	1.41	.440
216P-8	1/2	7/8	1.81	.564
216P-12	3/4	1-1/16	1.81	.752

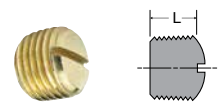

### Slotted-Head Plug 220P

PART NO.	PIPE THREAD	L
220P-2	1/8	.31
220P-4	1/4	.42
220P-6	3/8	.43

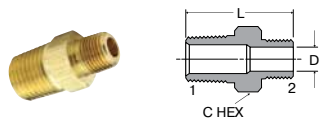

### Hex Nipple Reducers 216P

PART NO.	1 PIPE THREAD	2 PIPE THREAD	C HEX	L	FLOW DIA. D
216P-4-2	1/4	1/8	9/16	1.19	.220
216P-6-2	3/8	1/8	11/16	1.22	.220
216P-6-4	3/8	1/4	11/16	1.41	.314
216P-8-4	1/2	1/4	7/8	1.62	.314
216P-8-6	1/2	3/8	7/8	1.62	.440
216P-12-8	3/4	1/2	1-1/16	1.80	.564

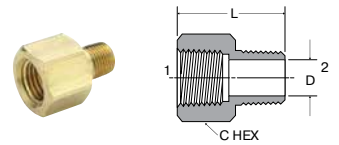

### Adapter 222P

PART NO.	1 PIPE THREAD	2 PIPE THREAD	C HEX	L	FLOW DIA. D
222P-2-2	1/8	1/8	9/16	.88	.220
222P-4-2	1/4	1/8	3/4	1.06	.220
222P-4-4	1/4	1/4	3/4	1.25	.314
222P-6-2	3/8	1/8	7/8	1.10	.220
222P-6-4	3/8	1/4	7/8	1.25	.314
222P-6-6	3/8	3/8	7/8	1.25	.440
222P-8-4	1/2	1/4	1	1.47	.314
222P-8-6	1/2	3/8	1-1/16	1.47	.440
222P-8-8	1/2	1/2	1-1/16	1.66	.564
222P-12-6	3/4	3/8	1-3/8	1.50	.440
222P-12-8	3/4	1/2	1-3/8	1.69	.564
222P-12-12	3/4	3/4	1-3/8	1.69	.752

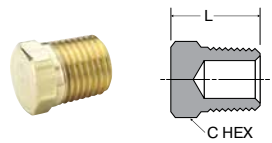

### Hex-Head Plug 218P

PART NO.	PIPE THREAD	C HEX	L
218P-2	1/8	7/16	.560
218P-4	1/4	9/16	.747
218P-6	3/8	11/16	.780
218P-8	1/2	7/8	.970
218P-12	3/4	1-1/16	1.054

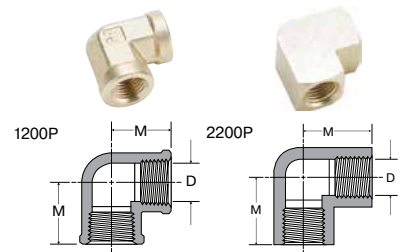

### 90° Union Elbow 1200P-2200P

PART NO.	PIPE THREAD	M	FLOW DIA. D
1200P-2-2	1/8	.56	.329
2200P-2-2	1/8	.55	.339
1200P-4-4	1/4	.81	.441
2200P-4-4	1/4	.78	.441
1200P-6-6	3/8	.84	.571
2200P-6-6	3/8	.84	.571
2200P-8-8	1/2	1.07	.703

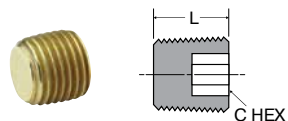

### Countersunk Hex-Head Plug 219P

PART NO.	PIPE THREAD	C HEX	L
219P-2	1/8	3/16	.30
219P-4	1/4	1/4	.46
219P-6	3/8	5/16	.46
219P-8	1/2	3/8	.61
219P-12	3/4	9/16	.62

**WARNING** These products can expose you to chemicals including LEAD which is known to the state of California to cause cancer and birth defects or other reproductive harm. For more information go to [www.P65Warnings.ca.gov](http://www.P65Warnings.ca.gov).

Click here for CADs, Product Specifications or to Configure Parts Online

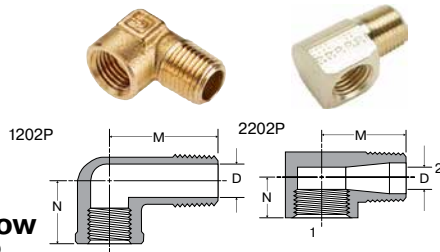

**90° Street Elbow  
1202P-2202P**

PART NO.	1 PIPE THREAD	2 PIPE THREAD	M	N	FLOW DIA. D
1202P-2-2	1/8	1/8	.81	.56	.22
2202P-2-2	1/8	1/8	.62	.48	.22
2202PA-2-2*	1/8	1/8	.66	.48	.22
2202P-4-2	1/4	1/8	.72	.45	.23
1202P-4-4	1/4	1/4	1.08	.69	.31
2202P-4-4	1/4	1/4	.91	.45	.34
2202PA-4-4*	1/4	1/4	.91	.72	.31
2202P-4-6	1/4	3/8	.97	.78	.43
1202P-6-4	3/8	1/4	1.25	.78	.31
1202P-6-6	3/8	3/8	1.25	.78	.42
2202P-6-6	3/8	3/8	.98	.54	.41
2202PA-6-6*	3/8	3/8	.97	.78	.43
1202P-6-8	3/8	1/2	1.53	1.01	.56
1202P-8-6	1/2	3/8	1.25	.97	.42
2202P-8-8	1/2	1/2	1.25	1.03	.56
2202P-12-8	3/4	1/2	1.39	1.10	.56
2202P-12-12	3/4	3/4	1.39	1.10	.75

\*Meets SAE Dimensions

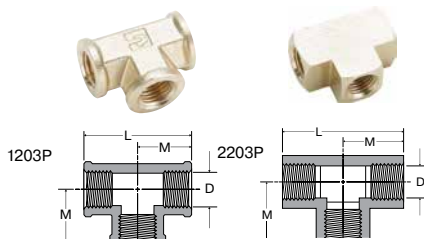

**Union Tee  
1203P-2203P**

PART NO.	PIPE THREAD	L	M	FLOW DIA. D
1203P-2	1/8	1.12	.56	.339
2203P-2	1/8	1.06	.53	.339
1203P-4	1/4	1.38	.69	.441
2203P-4	1/4	1.52	.76	.441
2203P-6	3/8	1.68	.84	.571
1203P-8	1/2	2.14	1.07	.703
2203P-8	1/2	2.14	1.07	.703
2203P-12	3/4	2.28	1.14	.906

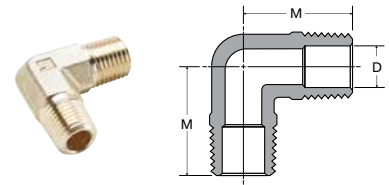

**Male Elbow 1204P**

PART NO.	PIPE THREAD	M	FLOW DIA. D
1204P-2	1/8	.71	.220
1204P-4	1/4	1.09	.312
1204P-6	3/8	1.09	.408
1204P-8	1/2	1.41	.502

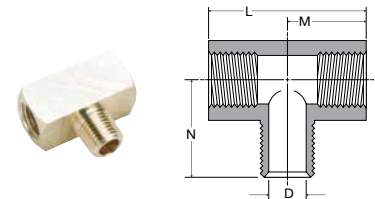

**Male Branch Tee 2224P**

PART NO.	PIPE THREAD	L	M	N	FLOW DIA. D
2224P-2	1/8	1.06	.53	.66	.220
2224P-4	1/4	1.52	.76	.91	.314
2224P-6	3/8	1.68	.84	.97	.440
2224P-8	1/2	2.18	1.09	1.25	.564
2224P-12	3/4	2.32	1.16	1.38	.752

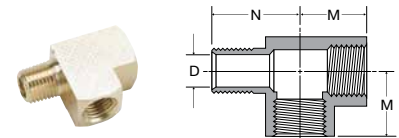

**Street Tee 2225P**

PART NO.	PIPE THREAD	M	N	DIA. D
2225P-2	1/8	.53	.66	.220
2225P-4	1/4	.76	.91	.314
2225P-6	3/8	.84	.98	.440
2225P-8	1/2	1.07	1.26	.564
2225P-12	3/4	1.14	1.38	.752

**WARNING** These products can expose you to chemicals including LEAD which is known to the state of California to cause cancer and birth defects or other reproductive harm. For more information go to [www.P65Warnings.ca.gov](http://www.P65Warnings.ca.gov).



[Click here for CADs, Product Specifications or to Configure Parts Online](#)

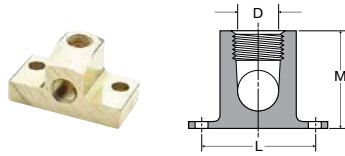

**Drop-ear 90° Elbow  
2200PDE**

PART NO.	PIPE THREAD	L	M	FLOW DIA. D
2200PDE-2	1/8	1.38	1.00	.339

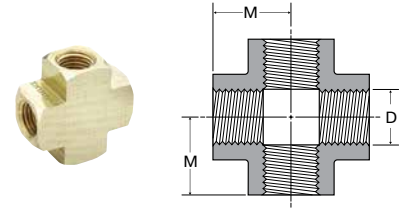

**Cross 2205P**

PART NO.	PIPE THREAD	M	FLOW DIA. D
2205P-2	1/8	.53	.339
2205P-4	1/4	.75	.441
2205P-6	3/8	.81	.571
2205P-8	1/2	1.07	.703
2205P-12	3/4	1.14	.906

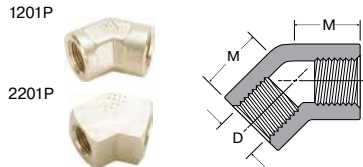

**45° Female Elbow  
1201P-2201P**

PART NO.	PIPE THREAD	M	FLOW DIA. D
2201P-2-2	1/8	.43	.339
1201P-8-8	1/2	.89	.703

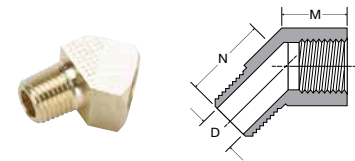

**45° Street Elbow  
2214P**

PART NO.	PIPE THREAD	M	N	FLOW DIA. D
2214P-2-2	1/8	.38	.50	.220
2214P-4-4	1/4	.54	.70	.314
2214P-6-6	3/8	.56	.78	.440
2214P-8-8	1/2	.73	1.00	.564
2214P-12-12	3/4	.75	1.35	.750

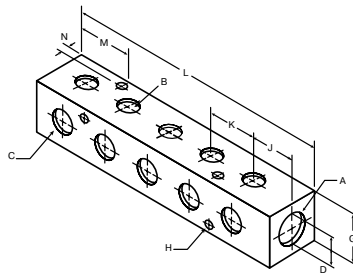

**Brass Manifold 255M**

PART NO.	PIPE THREAD A	PIPE THREAD B	PIPE THREAD C	G	MOUNTING HOLE DIA. H	J	K	L	M	N	D
X255MP-6-4-2	3/8	1/8	1/4	1.25	.22	.88	1.13	6.25	1.45	.25	.25

**WARNING** These products can expose you to chemicals including LEAD which is known to the state of California to cause cancer and birth defects or other reproductive harm. For more information go to [www.P65Warnings.ca.gov](http://www.P65Warnings.ca.gov).







# Metric Adapters

Parker's Metric Adapters offers a comprehensive range of NPT, BSPT, BSPP and metric pipe threads. Metric adapters are produced in both forgings and extrusions.

## Product Features:

- All brass construction
- Nickel plated adapters
- Robust design
- Reusable

## Markets:

- Industrial
- Construction
- Heavy duty truck
- Mobile
- Factory/process automation

## Applications:

- Air Lines
- Water Line
- Cooling Lines

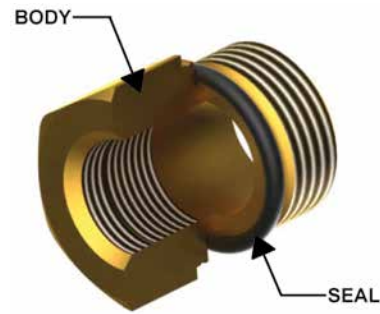

## Specifications:

	Pressure Range	Temperature Range
<b>Brass</b>	1/8" to 1/2": 2900 PSI (200 bar)	-76F to +302F (-60°C to +150°C)
	3/4" and 1": 2175 PSI (150 bar) without sealing washer	-4F to +34F (-20°C to +100°C) with sealing washer
<b>Nickel-plated Brass</b>	870 PSI (59.9 bar)	+14F to +176F (-10°C to +80°C)

**WARNING** These products can expose you to chemicals including LEAD which is known to the state of California to cause cancer and birth defects or other reproductive harm. For more information go to [www.P65Warnings.ca.gov](http://www.P65Warnings.ca.gov).



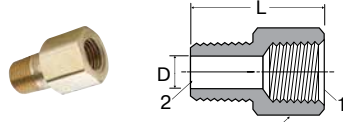

**F3HG Adapter NPTF Male BSPT**

PART NO.	NPTF 1	BSPT 2	C HEX	L	FLOW D
1/8F3HG-B	1/8	1/8	9/16	.93	.22
1/4F3HG-B	1/4	1/4	3/4	1.35	.31
3/8F3HG-B	3/8	3/8	7/8	1.35	.44
1/2F3HG-B	1/2	1/2	1-1/16	1.76	.56

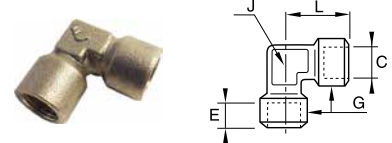

**0143 90° Union Elbow BSPP**

PART NO.	C BSPP	E MM	G MM	J MM	L MM	WT. KG
0143 10 10	G1/8	7.5	16.5	12	22.5	.042
0143 13 13	G1/4	11	18.5	15	26.5	.055
0143 17 17	G3/8	11.5	23.5	19	31.5	.098
0143 21 21	G1/2	15	28	23	35.5	.158
0143 27 27	G3/4	16.5	34	27	43.5	.256

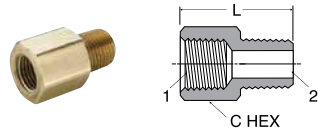

**0164 Adapter Male NPT/Female BSPP**

PART NO.	BSPP 1	NPTF 2	C HEX	L
0164 11 10	1/8	1/8	14	20
0164 14 13	1/4	1/4	17	27.5
0164 18 17	3/8	3/8	22	28.5
0164 22 21	1/2	1/2	27	36.5
0164 28 27	3/4	3/4	32	38.5

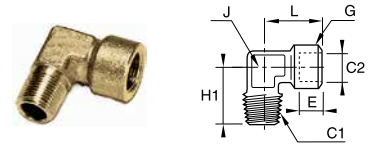

**0144 Street Elbow Female BSPP to Male BSPT**

PART NO.	C1 BSPT	C2 BSPP	E MM	G MM	H1 MM	J MM	L MM	WT. KG
0144 10 10	R1/8	G1/8	7.5	16.5	23	12	22.5	.033
0144 13 13	R1/4	G1/4	11	18.5	26	15	26.5	.050
0144 17 17	R3/8	G3/8	11.5	23.5	30	19	31.5	.085
0144 21 21	R1/2	G1/2	15	28	35	23	34.5	.138
0144 27 27	R3/4	G3/4	16.5	34	40	27	43.5	.229

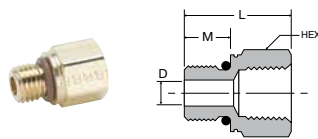

**Pipe to Metric Adaptor 222P-X-MIX**

PART NO.	NPTF	METRIC THREAD	HEX	L	M	D
222P-2-MI10	1/8-27	M10 X 1.0	9/16	.75	.34	.18
222P-2-MI14	1/8-27	M14 X 1.5	3/4	.91	.43	.30
222P-4-MI12	1/4-18	M12 X 1.5	11/16	1.09	.43	.24
222P-6-MI16	3/8-18	M16 X 1.5	7/8	1.10	.45	.35
222P-6-MI22	3/8-18	M22 X 1.5	1 1/16	1.05	.37	.47
222P-8-MI27	1/2-14	M27 X 2.0	1 1/4	1.32	.63	.60

Note: Fluorocarbon o-ring is standard

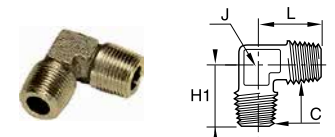

**0152 Union Elbow Male BSPT**

PART NO.	C BSPT	H1 MM	J MM	L MM	WT. KG
0152 10 10	R1/8	19.5	10	19.5	.018
0152 13 13	R1/4	25	15	25	.045
0152 17 17	R3/8	26.5	15	26.5	.056
0152 21 21	R1/2	31.5	19	31.5	.087
0152 27 27	R3/4	35.5	23	35.5	.153

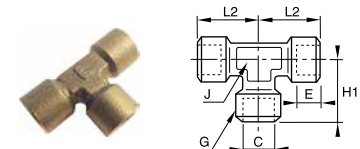

**0145 Female Union Tee BSPP**

PART NO.	C BSPP	E MM	G MM	H1 MM	J MM	L2 MM	WT. KG
0145 10 10	G1/8	7.5	16.5	22.5	12	22.5	.051
0145 13 13	G1/4	11	18.5	26.5	15	26.5	.074
0145 17 17	G3/8	11.5	23.5	31	19	31	.147
0145 21 21	G1/2	15	28	38	23	38	.231
0145 27 27	G3/4	16.5	34	47.5	27	47.5	.381

**WARNING** These products can expose you to chemicals including LEAD which is known to the state of California to cause cancer and birth defects or other reproductive harm. For more information go to [www.P65Warnings.ca.gov](http://www.P65Warnings.ca.gov).



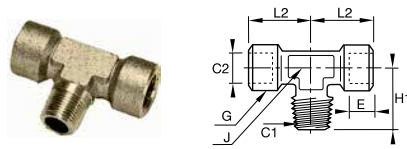

**0158 Branch Tee Female BSPP to Male BSPT**

PART NO.	C1 BSPT	C2 BSPP	E MM	G MM	H1 MM	J MM	L2 MM	WT. KG
0158 10 10	R1/8	G1/8	7.5	16.5	21.5	12	21.5	.045
0158 13 13	R1/4	G1/4	11	18.5	26	15	26	.071
0158 17 17	R3/8	G3/8	11.5	23.5	30	19	30	.118
0158 21 21	R1/2	G1/2	15	28	36	23	36	.203
0158 27 27	R3/4	G3/4	16.5	34	44	27	44	.320

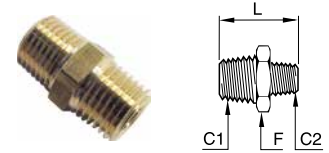

**0121 Hex Nipple Male BSPT**

PART NO.	C1 BSPT	C2 BSPT	F MM	L MM	WT. KG
0121 10 10	R1/8	R1/8	11	19	.009
0121 13 13	R1/4	R1/4	14	27	.021
0121 13 10	R1/4	R1/8	14	23.5	.021
0121 17 17	R3/8	R3/8	17	28	.025
0121 17 13	R3/8	R1/4	17	27.5	.024
0121 17 10	R3/8	R1/8	17	24	.022
0121 21 21	R1/2	R1/2	22	36	.053
0121 21 17	R1/2	R3/8	22	32.5	.045
0121 21 13	R1/2	R1/4	22	32	.045
0121 21 10	R1/2	R1/8	22	28.5	.041
0121 27 27	R3/4	R3/4	27	40	.092
0121 27 21	R3/4	R1/2	27	39	.084
0121 27 17	R3/4	R3/8	27	35.5	.076
0121 27 13	R3/4	R1/4	27	35	.079
0121 34 34	R1	R1	36	46	.156
0121 34 27	R1	R3/4	36	43	.143
0121 34 21	R1	R1/2	36	42	.133
0121 34 17	R1	R3/8	36	38.5	.126
0121 42 42	R1-1/4	R1-1/4	46	53	.233
0121 42 34	R1-1/4	R1	46	50.5	.237
0121 42 27	R1-1/4	R3/4	46	47.5	.229
0121 42 21	R1-1/4	R1/2	46	46.5	.219

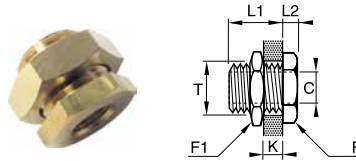

**0117 Bulkhead BSPP and M5**

PART NO.	C BSPP/M5	F MM	F1 MM	K MAX MM	L1 MM	L2 MM	T MAX MM	WT. KG
0117 00 19	M5X0.8	14	14	7	10.5	3.5	10.5	.013
0117 00 10	G1/8	19	22	9	14	4	16.5	.033
0117 00 13	G1/4	24	27	15	21	4	20.5	.057
0117 00 17	G3/8	30	32	14	21	5	26.5	.096
0117 00 21	G1/2	32	36	20	27	6	28.5	.117
0117 00 27	G3/4	41	41	22.5	30	6	34.5	.162
0117 00 34	G1	46	50	24.5	34	8	42.5	.270
0117 00 42	G1-1/4	55	55	29.5	39	8	49.5	.300
0117 00 49	G1-1/2	60	60	29.5	39	8	54.5	.306

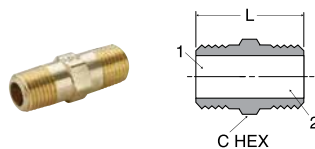

**0121 Hex Nipple NPT/BSPT**

PART NO.	NPT 1	BSPT 2	C HEX	L
0121 11 10	1/8	1/8	11	19
0121 14 13	1/4	1/4	14	27
0121 18 17	3/8	3/8	17	28
0121 22 21	1/2	1/2	22	36
0121 28 27	3/4	3/4	27	40

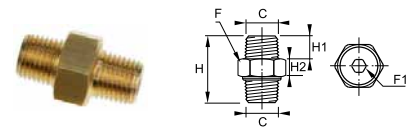

**0929 3 Piece Adapter Double Male BSPT**

PART NO.	C BSPT	F MM	F1 MM	H MM	H1 MM	H2 MM	WT. KG
0929 00 13	R1/4	19	6	33.5	11.5	9.5	0.100
0929 00 17	R3/8	22	8	36.5	13	10	0.010
0929 00 21	R1/2	27	12	45	15.5	12	0.088

Note: This connection accessory makes assembly easier thanks to its 3-piece design. To join the 2 threaded components, simply push together and tighten the nut.

**WARNING** These products can expose you to chemicals including LEAD which is known to the state of California to cause cancer and birth defects or other reproductive harm. For more information go to [www.P65Warnings.ca.gov](http://www.P65Warnings.ca.gov).



- A
- B
- C
- D
- E
- F
- G
- H
- I
- J
- K
- L
- M
- N
- O

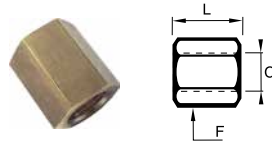

**0155 Coupling BSPP**

PART NO.	C BSPP	F MM	L MM	WT. KG
0155 10 10	G1/8	14	17	.015
0155 13 13	G1/4	17	24	.025
0155 17 17	G3/8	22	25	.045
0155 21 21	G1/2	27	32	.084
0155 27 27	G3/4	32	35	.109

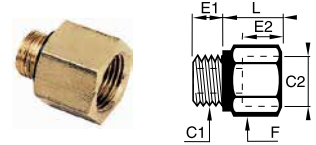

**0169 Expander Female BSPP to Male BSPP**

PART NO.	C1 BSPP	C2 BSPP	E1 MM	E2 MM	F MM	L MM	WT. KG
0169 10 13	G1/8	G1/4	5	11	17	16	.020
0169 10 17	G1/8	G3/8	5	14	22	19.5	.038
0169 13 17	G1/4	G3/8	7	14	22	19.5	.042
0169 13 21	G1/4	G1/2	7	14.5	27	20.5	.061
0169 17 21	G3/8	G1/2	8	14.5	27	20.5	.062
0169 17 27	G3/8	G3/4	8	15.5	32	22	.082
0169 21 27	G1/2	G3/4	9.5	15.5	32	22.5	.088

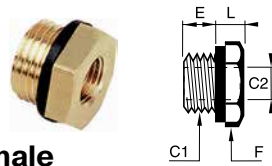

**0168 Adapter Reducer Female BSPP to Male BSPP**

PART NO.	C1 BSPP	C2 BSPP	E MM	F MM	L MM	WT. KG
0168 10 19	G1/8	M5X0.8	7	14	6	.008
0168 13 19	G1/4	M5X0.8	7	17	7	.010
0168 13 10	G1/4	G1/8	7	17	7	.010
0168 17 10	G3/8	G1/8	9	19	6	.020
0168 17 13	G3/8	G1/4	9	19	6	.013
0168 21 10	G1/2	G1/8	11	24	10	.046
0168 21 13	G1/2	G1/4	11	24	10	.038
0168 21 17	G1/2	G3/8	11	24	10	.026
0168 27 13	G3/4	G1/4	11	32	12	.090
0168 27 17	G3/4	G3/8	11	32	12	.078
0168 27 21	G3/4	G1/2	11	32	12	.058

\* With captive polymer seal

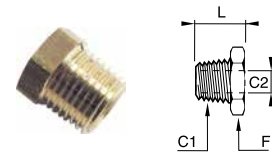

**0163 Adapter Reducer Female BSPP to Male BSPT**

PART NO.	C1 BSPT	C2 BSPP	F MM	L MM	WT. KG
0163 13 10	R1/4	G1/8	14	16	.009
0163 17 10	R3/8	G1/8	17	16.5	.020
0163 17 13	R3/8	G1/4	17	16.5	.012
0163 21 10	R1/2	G1/8	22	21	.047
0163 21 13	R1/2	G1/4	22	21	.038
0163 21 17	R1/2	G3/8	22	21	.025
0163 27 13	R3/4	G1/4	27	24	.086
0163 27 17	R3/4	G3/8	27	24	.069
0163 27 21	R3/4	G1/2	27	24	.048

**WARNING** These products can expose you to chemicals including LEAD which is known to the state of California to cause cancer and birth defects or other reproductive harm. For more information go to [www.P65Warnings.ca.gov](http://www.P65Warnings.ca.gov).



# Nickel Plated Metric Adapters

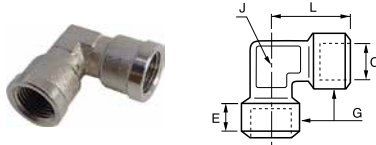

**0912 Female Elbow BSPP and M5**

PART NO.	C BSPP/M5	E MM	G MM	J MM	L MM	WT. KG
0912 00 19	M5	4	8	9	11	.037
0912 00 10	G1/8	8	13	10	21	.042
0912 00 13	G1/4	11	17	13	25.5	.055
0912 00 17	G3/8	11.5	21	17	28	.098
0912 00 21	G1/2	14	26	21	33.5	.158
0912 00 27	G3/4	15	31	27	36.5	.256

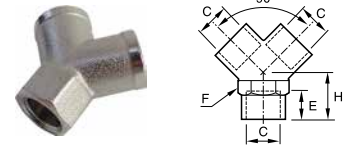

**0910 "Y" Connector Female BSPP**

PART NO.	C BSPP	E MM	F MM	H MM	WT. KG
0910 00 10	1/8	8	13	12	.055
0910 00 13	1/4	11	17	14	.081
0910 00 17	3/8	11.5	20	16	.128
0910 00 21	1/2	14	25	19	.213

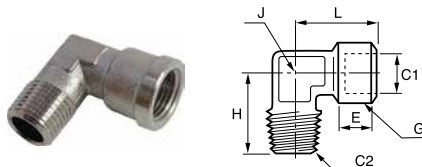

**0913 / 0921 Street Elbow Female BSPP to Male BSPT and M5**

PART NO.	C1 BSPP/M5	C2 BSPT	E MM	G MM	H MM	J MM	L MM	WT. KG
0921 00 19	M5		4	8	11	9	11	.037
0913 00 10	G1/8	R1/8	8	13	18.5	10	21	.033
0913 00 13	G1/4	R1/4	11	17	23.5	13	25.5	.050
0913 00 17	G3/8	R3/8	11.5	21	26	17	28	.085
0913 00 21	G1/2	R1/2	14	26	31	21	33.5	.138
0913 00 27	G3/4	R3/4	15	31	35	27	36.5	.229

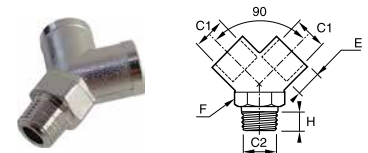

**0911 "Y" Connector Female BSPP to Male BSPT**

PART NO.	C1 BSPP	C2 BSPT	E	F	H	WT.
0911 00 10	G1/8	R1/8	8	13	12	.055
0911 00 13	G1/4	R1/4	11	17	14	.081
0911 00 17	G3/8	R3/8	11.5	20	16	.128
0911 00 21	G1/2	R1/2	14	25	19	.213

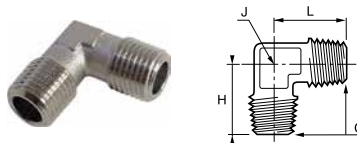

**0914 / 0922 Equal Elbow Male BSPT or M5**

PART NO.	C BSPT/M5	H MM	J MM	L MM	WT. KG
0922 00 19	M5	11	9	11	.037
0914 00 10	R1/8	18.5	10	18.5	.018
0914 00 13	R1/4	23.5	13	23.5	.045
0914 00 17	R3/8	26	17	26	.056
0914 00 21	R1/2	31	21	31	.087
0914 00 27	R3/4	35	27	35	.153

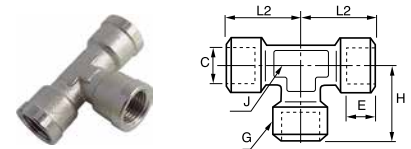

**0915 Female Tee BSPP or M5**

PART NO.	C BSPP/M5	E MM	G MM	H MM	J MM	L2 MM	WT. KG
0915 00 19	M5	4	8	11	9	11	.047
0915 00 10	G1/8	8	13	21	10	21	.051
0915 00 13	G1/4	11	17	25.5	13	25.5	.074
0915 00 17	G3/8	11.5	21	28	17	28	.147
0915 00 21	G1/2	14	26	33.5	21	33.5	.231
0915 00 27	G3/4	15	31	36.5	27	36.5	.381

**WARNING** These products can expose you to chemicals including LEAD which is known to the state of California to cause cancer and birth defects or other reproductive harm. For more information go to [www.P65Warnings.ca.gov](http://www.P65Warnings.ca.gov).



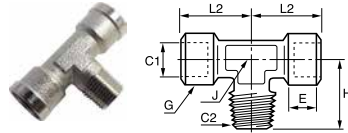

**0916 / 0923 Branch Tee Female BSPP to Male BSPT**

PART NO.	C1 BSPP/M5	C2 BSPT	E MM	G MM	H MM	J MM	L2 MM	WT. KG
0923 00 19	M5		4	8	11	9	11	.040
0916 00 10	G1/8	R1/8	8	13	18.5	10	21	.045
0916 00 13	G1/4	R1/4	11	17	23.5	13	25.5	.071
0916 00 17	G3/8	R3/8	11.5	21	26	17	28	.118
0916 00 21	G1/2	R1/2	14	26	31	21	33.5	.203
0916 00 27	G3/4	R3/4	15	31	36.5	27	36.5	.320

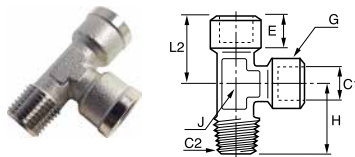

**0917 / 0924 Run Tee Female BSPP to Male BSPT or M5**

PART NO.	C1 BSPP/M5	C2 BSPT	E MM	G MM	H MM	J MM	L2 MM	WT. KG
0924 00 19	M5		4	8	11	9	11	.040
0917 00 10	G1/8	R1/8	8	13	18.5	10	21	.045
0917 00 13	G1/4	R1/4	11	17	23.5	13	25.5	.071
0917 00 17	G3/8	R3/8	11.5	21	26	17	28	.118
0917 00 21	G1/2	R1/2	14	26	31	21	33.5	.203
0917 00 27	G3/4	R3/4	15	31	36.5	27	36.5	.320

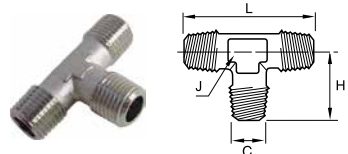

**0927 Equal Male Tee BSPT**

PART NO.	C BSPT	H MM	J MM	L MM	WT. KG
0927 00 10	R1/8	18.5	10	37	.017
0927 00 13	R1/4	23.5	13	47	.038
0927 00 17	R3/8	26	17	52	.057
0927 00 21	R1/2	31	21	62	.093

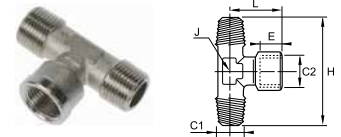

**0928 Male Stud Branch Tee BSPT Female BSPP**

PART NO.	C1 BSPT	C2 BSPP	E MM	H MM	J MM	L MM	WT. KG
0928 00 10	R1/8	G1/8	8	37	10	21	0.021
0928 00 13	R1/4	G1/4	11	47	13	25.5	0.044
0928 00 17	R3/8	G3/8	11.5	52	17	28	0.066
0928 00 21	R1/2	G1/2	14	62	21	33.5	0.109

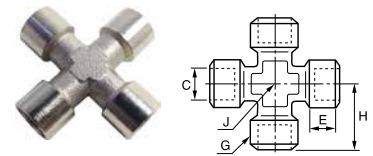

**0908 Cross Female BSPP**

PART NO.	C BSPP	E MM	G MM	H MM	J MM	WT. KG
0908 00 10	G1/8	8	13	21	10	.055
0908 00 13	G1/4	11	17	25.5	13	.081
0908 00 17	G3/8	11.5	21	28	17	.128
0908 00 21	G1/2	14	26	33.5	21	.213

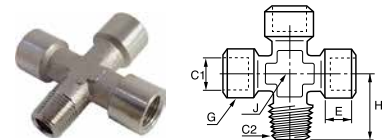

**0909 Cross Female BSPP to Male BSPT**

PART NO.	C1 BSPP	C2 BSPT	E MM	G MM	H MM	J MM	WT. KG
0909 00 10	G1/8	R1/8	8	13	18.5	10	.055
0909 00 13	G1/4	R1/4	11	17	23.5	13	.081
0909 00 17	G3/8	R3/8	11.5	21	26	17	.128
0909 00 21	G1/2	R1/2	14	26	31	21	.213

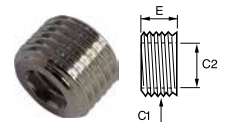

**0903 Adapter Reducer BSPP**

PART NO.	C1 BSPP	C2 BSPP	E MM	WT. KG
0903 10 13	G1/4	G1/8	8	.009
0903 13 17	G3/8	G1/4	9	.020
0903 17 21	G1/2	G3/8	10	.025
0903 21 27	G3/4	G1/2	14	.048
0903 27 34	G1"	G3/4	20	.060

**WARNING** These products can expose you to chemicals including LEAD which is known to the state of California to cause cancer and birth defects or other reproductive harm. For more information go to [www.P65Warnings.ca.gov](http://www.P65Warnings.ca.gov).

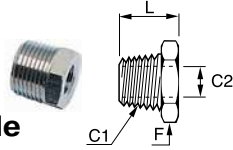

**0904 Adapter Reducer Female BSPP to Male BSPT**

PART NO.	C1 BSPT	C2 BSPP	F MM	L MM	WT. KG
0904 10 13	R1/4	G1/8	14	16	.009
0904 10 17	R3/8	G1/8	17	16.5	.020
0904 13 17	R3/8	G1/4	17	16.5	.012
0904 13 21	R1/2	G1/4	22	19.5	.038
0904 17 21	R1/2	G3/8	22	19.5	.025
0904 17 27	R3/4	G3/8	27	23.5	.069
0904 21 27	R3/4	G1/2	27	23.5	.048

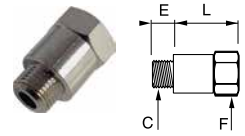

**0907 Extended Adapter BSPP**

PART	C BSPP	E MM	F MM	L MM	WT. KG
0907 00 10	G1/8	6	14	16	.009
0907 00 10 01	G1/8	6	14	36	.009
0907 00 13	G1/4	8	17	23	.020
0907 00 13 01	G1/4	8	17	43	.020

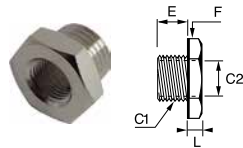

**0905 Adapter Reducer Male BSPP to Female BSPP or M5**

PART NO.	C1 BSPP	C2 BSPP M5	E MM	F MM	L MM	WT. KG
0905 19 10	G1/8	M5	6	14	4.5	.009
0905 10 13	G1/4	G1/8	8	17	5	.009
0905 10 17	G3/8	G1/8	9	19	5	.020
0905 13 17	G3/8	G1/4	9	19	5	.012
0905 13 21	G1/2	G1/4	10	24	5.5	.038
0905 17 21	G1/2	G3/8	10	24	5.5	.025
0905 17 27	G3/4	G3/8	12	30	5.5	.069
0905 21 27	G3/4	G1/2	12	30	5.5	.048

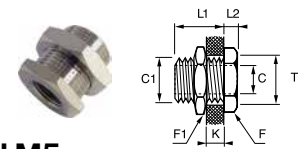

**0920 Bulkhead BSPP and M5**

PART NO.	C1 METRIC	C BSPP M5	F MM	F1 MM	K MAX MM	L1 MM	L2 MM	T MIN MM	WT. KG
0920 00 19	M10X1	M5	14	14	7	10.5	3.5	10.5	.013
0920 00 10	M16X1.5	G1/8	19	22	9	14	4	16.5	.033
0920 00 13	M20X1.5	G1/4	24	27	15	21	4	20.5	.057
0920 00 17	M26X1.5	G3/8	30	32	14	21	5	26.5	.096
0920 00 21	M28X1.5	G1/2	32	36	20	27	6	28.5	.117

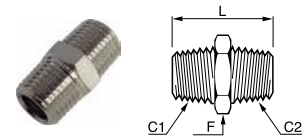

**0900 Male Straight Adapter BSPT**

PART NO.	C1 BSPT	C2 BSPT	F MM	L MM	WT. KG
0900 00 10	R1/8	R1/8	12	19.5	.009
0900 10 13	R1/8	R1/4	14	23.5	.021
0900 00 13	R1/4	R1/4	14	27	.021
0900 10 17	R1/8	R3/8	17	24	.022
0900 13 17	R1/4	R3/8	17	27.5	.024
0900 00 17	R3/8	R3/8	17	28	.025
0900 13 21	R1/4	R1/2	22	30.5	.045
0900 17 21	R3/8	R1/2	22	31	.045
0900 00 21	R1/2	R1/2	22	33.5	.055
0900 21 27	R1/2	R3/4	27	37.5	.084
0900 00 27	R3/4	R3/4	27	40	.092
0900 27 34	R3/4	R1	34	43	.143
0900 00 34	R1	R1	34	45.5	.156

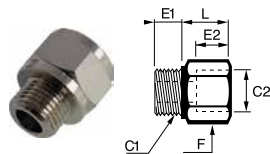

**0906 Expander Female BSPP to Male BSPP**

PART NO.	C1 BSPP/M5	C2 BSPP	E1 MM	E2 MM	F MM	L MM	WT. KG
0906 10 19	M5	G1/8	4	8	14	10	.009
0906 00 10	G1/8	G1/8	6	8.5	14	10	.009
0906 10 13	G1/8	G1/4	6	11.5	17	14	.020
0906 10 17	G1/8	G3/8	6	11.5	22	14.5	.038
0906 00 13	G1/4	G1/4	8	11.5	17	14	.040
0906 13 17	G1/4	G3/8	8	11.5	22	14.5	.042
0906 13 21	G1/4	G1/2	8	15	27	18	.061
0906 00 17	G3/8	G3/8	9	11.5	22	14.5	.061
0906 17 21	G3/8	G1/2	9	15	27	18	.062
0906 00 21	G1/2	G1/2	10	15	27	18	.070

**WARNING** These products can expose you to chemicals including LEAD which is known to the state of California to cause cancer and birth defects or other reproductive harm. For more information go to [www.P65Warnings.ca.gov](http://www.P65Warnings.ca.gov).



- A
- B
- C
- D
- E
- F
- G
- H
- I
- J
- K
- L
- M
- N
- O

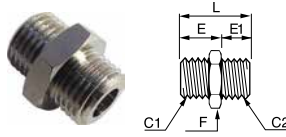

### 0901 Male Straight Adapter M5 or BSPP

PART NO.	C1 BSPP M5	C2 BSPP M5	E MM	E1 MM	F MM	L MM	WT. KG
0901 00 19	M5	M5	4	4	8	11.5	.002
0901 19 10	M5	G1/8	4	6	14	14.5	.008
0901 00 10	G1/8	G1/8	6	6	14	16.5	.008
0901 10 13	G1/8	G1/4	6	8	17	19	.014
0901 00 13	G1/4	G1/4	8	8	17	21	.016
0901 13 17	G1/4	G3/8	8	9	19	22	.021
0901 00 17	G3/8	G3/8	9	9	19	23	.024

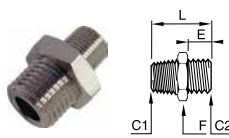

### 0192 Male Straight Adapter BSPT to BSPP

PART NO.	C1 BSPT	C2 BSPP	E MM	F MM	L MM	WT. KG
0192 10 13	R1/8	G1/4	9.5	17	23.5	.019
0192 13 13	R1/4	G1/4	9.5	17	27.5	.024
0192 13 21	R1/4	G1/2	27	27	31.5	.067
0192 17 13	R3/8	G1/4	9.5	17	45	.025
0192 17 21	R3/8	G1/2	27	27	31.5	.061
0192 21 21	R1/2	G1/2	27	27	34	.060

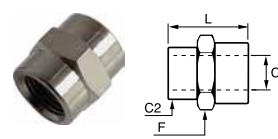

### 0902 Female Sleeve BSPP and M5

PART NO.	C1 BSPP/M5	C2 BSPP/M5	F MM	L MM	WT. KG
0902 00 19	M5	M5	8	11	.009
0902 19 10	M5	G1/8	14	13	.009
0902 00 10	G1/8	G1/8	14	15	.015
0902 10 13	G1/8	G1/4	17	19.5	.020
0902 00 13	G1/4	G1/4	17	22	.025
0902 10 17	G1/8	G3/8	22	20	.030
0902 13 17	G1/4	G3/8	22	23	.040
0902 00 17	G3/8	G3/8	22	24	.045
0902 13 21	G1/4	G1/2	27	27	.050
0902 17 21	G3/8	G1/2	27	27.5	.060
0902 00 21	G1/2	G1/2	27	30	.084
0902 21 27	G1/2	G3/4	30	30	.090
0902 00 27	G3/4	G3/4	30	32	.109

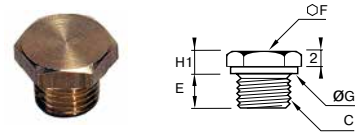

### 0200 Hex Head Plug BSPP and Metric

PART NO.	C BSPP	E MM	F MM	G MM	H1 MM	H2 MM	WT. KG
0200 10 00	G1/8	7	14	13.7	5.5	4	.012
0200 13 00	G1/4	8.5	17	16.7	5.5	4	.019

PART NO.	C METRIC	E MM	F MM	G MM	H1 MM	H2 MM	WT. KG
0200 52 00	M6X1	6	10	10	4	3.5	.004
0200 57 00	M8X1.25	7	13	13	4	3.5	.007
0200 60 00	M10X1	8	14	14	5	4.5	.012
0200 65 00	M12X1	9	17	17	5	4.5	.018
0200 66 00	M10X1.25	9	17	17	5	4.5	.018

Parallel metric threads ISO – standards NFE 03-054 and BNA 541. Parallel metric threads – standards NFE 03-005 and BNA 541.

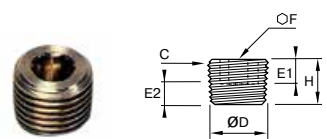

### 0205 Internal Hex Head Plug NPT and BSPT

PART NO.	C NPT	OD IN	E1 IN	E2 MIN IN	E2 MAX IN	F IN	H IN	WT. OZ
0205 11 00	1/8	.40	.24	.12	.20	.79	.31	.141
0205 14 00	1/4	.54	.31	.17	.28	.94	.39	.282
0205 18 00	3/8	.67	.31	.18	.29	1.22	.43	.494
0205 22 00	1/2	.93	.31	.25	.39	1.53	.51	.917
0205 28 00	3/4	1.04	.43	.27	.41	2.16	.67	1.834
0205 35 00	1	1.31	.51	.31	.49	2.95	.75	3.245

PART NO.	C BSPT	OD MM	E1 MM	E2 MIN MM	E2 MAX MM	F MM	H MM	WT. KG
0205 10 00	R1/8	9.728	6	3.1	4.9	5	8	.004
0205 13 00	R1/4	13.157	8	4.7	7.3	6	10	.008
0205 17 00	R3/8	16.662	8	5.1	7.7	8	11	.014
0205 21 00	R1/2	20.955	8	6.4	10	10	13	.027
0205 27 00	R3/4	26.441	11	7.7	11.3	14	17	.053
0205 34 00	R1	33.249	13	8.1	12.7	17	19	.092
0205 42 00	R1-1/4	41.910	14	10.4	15	22	22	.183
0205 49 00	R1-1/2	47.803	14	10.4	15	24	22	.250
0205 48 00	R2	59.614	16	13.6	18.2	30	25	.440

For BSP taper plus 1/2" - 1 1/2" inclusive - thread standard NFE 03-004 - DIN906

**WARNING** These products can expose you to chemicals including LEAD which is known to the state of California to cause cancer and birth defects or other reproductive harm. For more information go to [www.P65Warnings.ca.gov](http://www.P65Warnings.ca.gov).



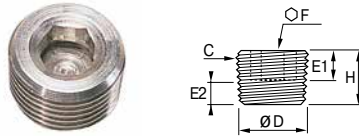

**0285 Internal Hex Head Plug NPT or BSPT**

PART NO.	C NPT	OD IN	E1 IN	E2 MIN IN	E2 MAX IN	F MM	H IN	WT. OZ
0285 11 00	1/8	.40	.24	.13	.20	5	.31	.14
0285 14 00	1/4	.54	.31	.17	.28	6	.39	.25
0285 18 00	3/8	.67	.31	.19	.30	8	.43	.49
0285 22 00	1/2	.84	.31	.25	.39	10	.51	.88

PART NO.	C BSPT	OD MM	E1 MM	E2 MIN MM	E2 MAX MM	F MM	H MM	WT. KG
0285 10 00	R1/8	9.72	6	3.1	4.9	5	8	.003
0285 13 00	R1/4	13.15	8	4.7	7.3	6	10	.007
0285 17 00	R3/8	16.66	8	5.1	7.7	8	11	.013
0285 21 00	R1/2	20.95	8	6.4	10	10	13	.025
0285 27 00	R3/4	26.44	11	7.7	11.3	14	17	.057
0285 34 00	R1	33.25	13	8.1	12.7	17	19	.098

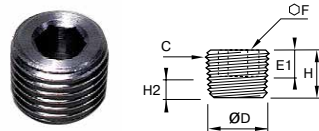

**0206 Internal Hex Head NPT and BSPT**

PART NO.	C NPT	OD IN	E1 IN	E2 MIN IN	E2 MAX IN	F MM	H IN	WT. OZ
0206 08 00	1/16	.31	.24	.15	.25	.16	.26	.070
0206 11 00	1/8	.40	.24	.12	.20	.20	.31	.106
0206 14 00	1/4	.54	.31	.17	.28	.24	.39	.247
0206 18 00	3/8	.67	.31	.18	.29	.31	.43	.423
0206 22 00	1/2	.83	.31	.25	.39	.39	.51	.847
0206 28 00	3/4	1.04	.43	.27	.41	.55	.67	1.658
0206 25 00	1	1.31	.51	.31	.49	.67	.75	2.928

PART NO.	C BSPT	OD MM	E1 MM	E2 MIN MM	E2 MAX MM	F MM	H MM	WT. KG
0285 10 00	R1/8	9.728	6	3.1	4.9	5	8	.003
0285 13 00	R1/4	13.157	8	4.7	7.3	6	10	.007
0285 17 00	R3/8	16.662	8	5.1	7.7	8	11	.013
0285 21 00	R1/2	20.955	8	6.4	10	10	13	.024
0285 27 00	R3/4	26.441	11	7.7	11.3	14	17	.048
0285 34 00	R1	33.249	13	8.1	12.7	17	19	.086
0285 34 00	R1-1/4	41.910	14	10.4	15	22	22	.162
0285 34 00	R1-1/2	47.803	14	10.4	15	24	22	.222

For BSP taper plugs 1/2" - 1 1/2" inclusive - conform to standard BNA 247 - thread - DIN 906 standard NFE 03-004

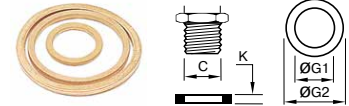

**0138 Copper Washer BSPP and Metric**

PART NO.	C BSPP/M5	G1 MM	G2 MM	K MM	WT. OZ
	M6	6.3	9	1	.033
	M8	8.3	11	1	.001
	M12	12.3	15.5	1.5	.072
	M14	14.3	18	1.5	.001
	M16	16.3	20	1.5	.001
	M18	18.3	22	1.5	.001
	M20	20.3	24	1.5	.001
	M22	22.3	27	1.5	.002
	M24	24.3	29	2	.003
	M26	26.3	31	2	.003
	M30	30.3	36	2	.004
	M36	36.3	42	2	.005
	M39	39.3	44	2	.007
	M45	45.3	52	2	.007
	M52	52.3	60	2	.009
	G1/8	10.3	13.5	1	.001
	G1/4	13.5	18	1.3	.001
	G3/8	17.3	21	1.5	.001
	G1/2	21.3	26	1.5	.002
	G3/4	27.3	32	2	.003
	G1	33.5	39	2	.005
	G1-1/4	42.5	49	2	.007
	G1-1/2	48.3	55	2	.008
	G2	60	68	2.5	.014

**WARNING** These products can expose you to chemicals including LEAD which is known to the state of California to cause cancer and birth defects or other reproductive harm. For more information go to [www.P65Warnings.ca.gov](http://www.P65Warnings.ca.gov).



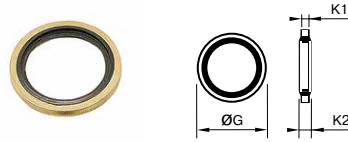

**0139 Bi-Material Captive Sealing Washer BSPP**

PART NO.	C BSPP	G MM	G2 MM	K MM	WT. OZ
0139 10 00	G1/8	14	1	1.8	.001
0139 13 00	G1/4	17	1	1.8	.001
0139 17 00	G3/8	22	1.3	2.1	.001
0139 21 00	G1/2	26	1.6	2.4	.002
0139 27 00	G3/4	32	1.6	2.4	.002
0139 34 00	G1	43	3.5	2.5	.002

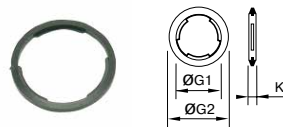

**0602 Captive Sealing Washer BSPP and M5**

PART NO.	C BSPP/M5	G1 MM	G2 MM	K MM	WT. OZ
0602 29 93 15	M5X0.8	5.2	7.8	1.5	.001
0602 23 10 20	G1/8	10.3	14	2	.001
0602 23 11 20	G1/4	13.7	17.5	2	.001
0602 23 12 20	G3/8	17.2	21	2	.001
0602 23 13 20	G1/2	21.5	25.5	2.5	.001
0602 27 32 20	G3/4	27	32	2.5	.001
0602 30 60 20	G1	33.8	39	3	.001

**WARNING** These products can expose you to chemicals including LEAD which is known to the state of California to cause cancer and birth defects or other reproductive harm. For more information go to [www.P65Warnings.ca.gov](http://www.P65Warnings.ca.gov).





# ISO Port Adapters

Parker's ISO Port Adapters meet dimensional requirements of ISO 6149-3.

## Product Features:

- All brass construction
- Fluorocarbon O-ring
- NPTF, flare, hose barb, NTA end configurations

## Markets:

- Industrial
- Construction
- Mobile
- Factory/process automation

## Applications:

- Air Lines
- Water Line
- Cooling Line

## Specifications:

<b>Pressure Range</b>	Dependent on tubing or hose end connection
<b>Temperature Range</b>	Dependent on tubing or hose end connection



**WARNING** These products can expose you to chemicals including LEAD which is known to the state of California to cause cancer and birth defects or other reproductive harm. For more information go to [www.P65Warnings.ca.gov](http://www.P65Warnings.ca.gov).



Click here for CADs, Product Specifications or to Configure Parts Online

- A
- B
- C
- D
- E
- F
- G
- H
- I
- J
- K
- L
- M
- N
- O

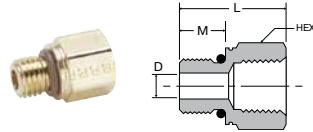

### Pipe to Metric Adaptor 222P-X-MIX

PART NUMBER	NPTF	METRIC THREAD	HEX	L	M	D
222P-2-MI10	1/8-27	M10 X 1.0	9/16	.75	.34	.18
222P-2-MI14	1/8-27	M14 X 1.5	3/4	.91	.43	.30
222P-4-MI12	1/4-18	M12 X 1.5	11/16	1.09	.43	.24
222P-4-MI14	1/4-18	M14 X 1.5	3/4	1.09	.43	.30
222P-6-MI16	3/8-18	M16 X 1.5	7/8	1.16	.45	.35
222P-6-MI22	3/8-18	M22 X 1.5	1 1/16	1.05	.51	.47
222P-8-MI27	1/2-14	M27 X 2.0	1 1/4	1.32	.63	.60

Note: Fluorocarbon o-ring is standard  
For working pressure and Temperature see Metric Adapters Section

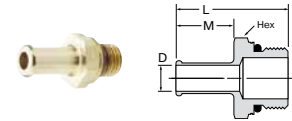

### Hose Barb to Metric Adaptor 68HB-X-MIX

PART NUMBER	TUBE SIZE	METRIC THREAD	HEX	L	M	D
68HB-6-MI12	3/8	M12 X 1.5	11/16	1.50	.78	.24
68HB-6-MI14	3/8	M14 1.5	3/4	1.51	.78	.30
68HB-8-MI12	1/2	M12 X 1.5	11/16	1.50	.78	.24
68HB-10-MI27	5/8	M27 X 2.0	1 1/4	1.77	.78	.50

Note: Fluorocarbon o-ring is standard  
For working pressure and Temperature see Hose Barb Section

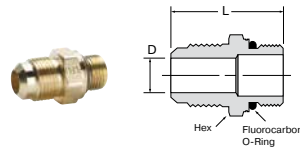

### Flare to Metric Adaptor 48F-X-MIX

PART NUMBER	TUBE SIZE	METRIC THREAD	HEX	L	D
48F-8-MI16	1/2	M16 X 1.5	7/8	1.60	.35
48F-10-MI27	5/8	M27 X 2.0	1 1/4	1.87	.50
48F-12-MI27	3/4	M27 X 2.0	1 1/4	1.99	.63

Note: Fluorocarbon o-ring is standard  
For working pressure and Temperature see SAE Flare Section

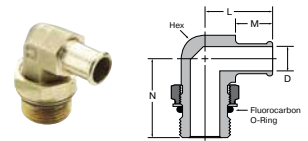

### Beaded Elbow to Metric Adaptor 169HB-X-MIX

PART NUMBER	HOSE SIZE	METRIC THREAD	HEX	L	M	N	D
169HB-10-MI27	5/8	M27 X 2.0	7/8	1.41	.78	1.63	.50
169HB-16-MI27	1	M27 X 2.0	1	1.67	.97	1.68	.71

Note: Fluorocarbon o-ring is standard  
For working pressure and Temperature see Hose Barb Section

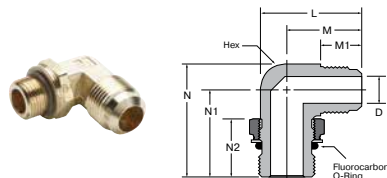

### Flare Elbow to Metric Adaptor 149F-X-MIX

PART NUMBER	TUBE SIZE	METRIC THREAD	HEX	L	M	M1	N	N1	N2	D
149F-10-MI27	5/8	M27 X 2.0	7/8	1.95	1.46	.88	2.12	1.63	1.09	.50

Note: Fluorocarbon o-ring is standard  
For working pressure and Temperature see SAE Flare Section

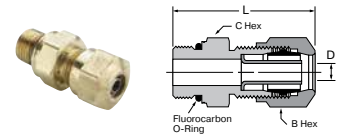

### NTA to Metric Adaptor 68NTA-X-MIX

PART NUMBER	TUBE SIZE	METRIC THREAD	B HEX	C HEX	L	D
68NTA-4-MI10	1/4	M10 X 1.0	9/16	9/16	1.33	.140

Note: Fluorocarbon o-ring is standard  
For working pressure and Temperature see Air Brake-NTA Section

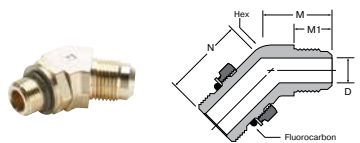

### 45° Flare Elbow to Metric Adaptor 159F-X-MIX

PART NUMBER	TUBE SIZE	METRIC THREAD	HEX	M	M1	N	D
159F-8-MI16	1/2	M16 X 1.5	13/16	1.10	.75	1.16	.36
159F-10-MI27	5/8	M27 X 2.0	1 1/8	1.21	.88	1.50	.50

Note: Fluorocarbon o-ring is standard  
For working pressure and Temperature see SAE Flare Section

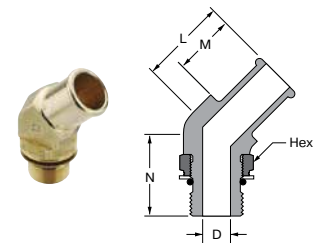

### Beaded Hose Barb 45° Elbow to Metric Thread 179HB-X-MIX

PART NUMBER	HOSE SIZE	METRIC THREAD	HEX	L	M	N	D
179HB-12-MI18	3/4	M18 X 1.5	13/16	1.15	.78	1.16	.44
179HB-16-MI27	1	M27 X 2.0	1 1/16	1.51	.97	1.71	.71

Note: Fluorocarbon o-ring is standard

**WARNING** These products can expose you to chemicals including LEAD which is known to the state of California to cause cancer and birth defects or other reproductive harm. For more information go to [www.P65Warnings.ca.gov](http://www.P65Warnings.ca.gov).



- A
- B
- C
- D
- E
- F
- G
- H
- I
- J
- K
- L
- M
- N
- O



# Garden Hose Fittings

Parker's Garden Hose Fittings connect garden hose to other garden hose, to pipe or to tubing. Swivel connections allow hose to twist without kinking.

## Product Features:

- All brass construction
- 3/4" garden hose thread
- Rubber washer
- Flare, hose barb and pipe end configurations
- High Flow couplings

## Markets:

- Industrial
- Mobile
- Factory/process automation

## Applications:

- Water Line

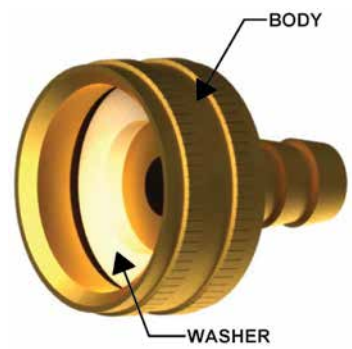

## Specifications:

<b>Pressure Range</b>	Up to 150 PSI (10.3 bar)
<hr/>	
<b>Temperature Range</b>	+35° to +100° F at 75 PSI (+1.6° to +37.7° C at 5.1 bar)
<hr/>	

## Compatible Tubing:

- Garden Hose

**Note:** 90Gh is intended for use with the 97HC hose clamp or crimped ferrule. All female connector ends should have a rubber washer(901GH-12) inserted prior to use.

**WARNING** These products can expose you to chemicals including CARBON BLACK, or LEAD, which are known to the state of California to cause cancer, and LEAD which is known to cause birth defects or other reproductive harm. For more information go to [www.P65Warnings.ca.gov](http://www.P65Warnings.ca.gov).

[Click here for CADs, Product Specifications or to Configure Parts Online](#)

### Hose Barb to Male Hose Thread 53GH, 54GH & 55GH

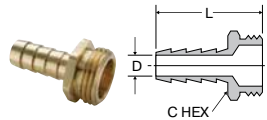

PART NO.	I.D. HOSE SIZE	HOSE THREAD	C HEX	L	FLOW DIA. D
53GH-8-12	1/2	3/4	1-1/16	1.88	.375
54GH-10-12	5/8	3/4	1-1/16	1.88	.500
55GH-12-12	3/4	3/4	1-1/16	1.88	.625

### Female Hose to Male Pipe 82GH & 83GH

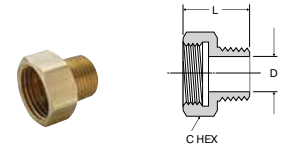

PART NO.	HOSE THREAD	PIPE THREAD	C HEX	L	FLOW DIA. D
82GH-12-8	3/4	1/2	1-3/16	1.20	.562
83GH-12-12	3/4	3/4	1-3/16	1.22	.750

### Male Hose to Male Pipe 69GH, 70GH, 71GH

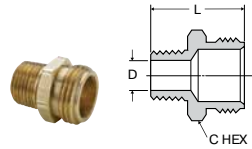

PART NO.	HOSE THREAD	PIPE THREAD	C HEX	L	FLOW DIA. D
69GH-12-4	3/4	1/4	1-1/16	1.25	.410
69GH-12-6	3/4	3/8	1-1/16	1.25	.406
70GH-12-8	3/4	1/2	1-1/16	1.39	.531
71GH-12-12	3/4	3/4	1-1/16	1.41	.750

### Swivel Connector Female Garden Hose to Male Pipe 88GH

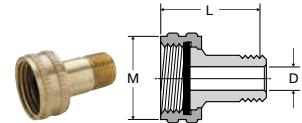

PART NO.	HOSE THREAD	PIPE THREAD	L	M	FLOW DIA. D
88GH-12-4	3/4	1/4	1.69	1.15	.312
88GH-12-6	3/4	3/8	1.69	1.15	.406

### Male Hose to Male Hose 75GH

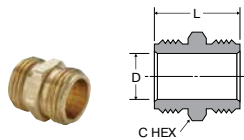

PART NO.	HOSE THREAD	C HEX	L	FLOW DIA. D
75GH-12	3/4	1-1/16	1.25	.750

### Swivel Connector Female Garden Hose to Hose Barb 90GH

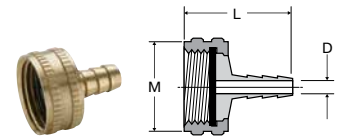

PART NO.	HOSE THREAD	I.D. HOSE SIZE	L	M	FLOW DIA. D
90GH-12-3	3/4	3/16	1.29	1.15	.125
90GH-12-4	3/4	1/4	1.21	1.15	.187
90GH-12-6	3/4	3/8	1.21	1.15	.281
90GH-12-8	3/4	1/2	1.21	1.15	.375
90GH-12-10*	3/4	5/8	1.93	1.19	.500
90GH-12-12*	3/4	3/4	1.93	1.19	.625

\*Denotes hex body

### Male Hose to Female Pipe 78GH, 79GH, 80GH & 81GH

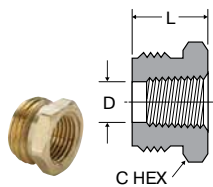

PART NO.	HOSE THREAD	PIPE THREAD	C HEX	L	FLOW DIA. D
78GH-12-4	3/4	1/4	1-1/16	.75	.422
79GH-12-6	3/4	3/8	1-1/16	.75	.562
80GH-12-8	3/4	1/2	1-1/16	.75	.687
81GH-12-12	3/4	3/4	1-3/16	1.28	.719

### Knurled Hose Nut 94GH

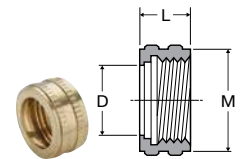

PART NO.	HOSE THREAD	L	M	FLOW DIA. D
94GH-12	3/4	.57	1.15	.808

**WARNING** These products can expose you to chemicals including CARBON BLACK, or LEAD, which are known to the state of California to cause cancer, and LEAD which is known to cause birth defects or other reproductive harm. For more information go to [www.P65Warnings.ca.gov](http://www.P65Warnings.ca.gov).



Click here for CADs, Product Specifications or to Configure Parts Online

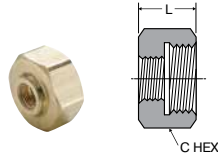

### Hose Nut Reducer 95GH

PART NO.	HOSE THREAD	PIPE THREAD	C HEX	L
95GH-12-2	3/4	1/8	1-1/8	.63

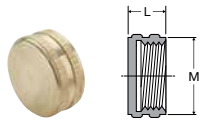

### Hose Cap Nut 96GH

PART NO.	HOSE THREAD	L	M
96GH-12	3/4	.50	1.15

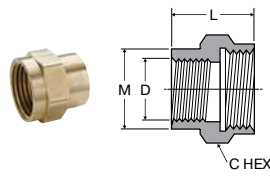

### Female Hose to Female Pipe 98GH & 99GH

PART NO.	HOSE THREAD	PIPE THREAD	C HEX	L	M	FLOW DIA. D
98GH-12-8	3/4	1/2	1-3/16	1.14	1.01	.687
99GH-12-12	3/4	3/4	1-3/16	1.25	1.17	.750

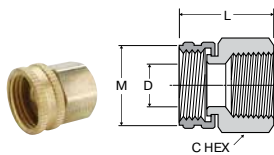

### Swivel Connector Female Hose to Female Pipe 98GHSV & 99GHSV

PART NO.	HOSE THREAD	PIPE THREAD	C HEX	L	M	FLOW DIA. D
98GHSV-12-8	3/4	1/2	1	1.27	1.21	.687
99GHSV-12-12	3/4	3/4	1-3/16	1.34	1.21	.687

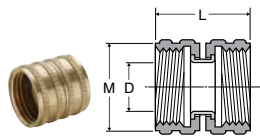

### Swivel Nut Connector 101GHSV

PART NO.	HOSE THREAD	L	M	FLOW DIA. D
101GHSV-12	3/4	1.25	1.15	.625



### Rubber Garden Hose Coupling Washer 901GH

PART NO.	HOSE THREAD
901GH-12	3/4

NOTE: All female connector ends should have this rubber washer

## Hydraulic Quick Couplings/ High Flow Couplings

#### Applications

Parker Water Service Couplings are used anywhere water hoses are connected and disconnected frequently. They are used on a wide variety of applications including garden hoses, wash down systems, and mobile water tank lines. The unvalved design permits maximum flow with minimum pressure drop.

#### Features

- Brass and stainless steel construction for heavy duty service.
- Durable 4-ball locking mechanism for secure connections.
- Quality, temperature-resistant nitrile seals for a leak-free service life.

#### Specifications

- Body Size 3/4"
- Rated Pressure PSI 200 (13.7 bar)
- Rated Flow GPM 28
- Temperature Range (std seals) -40° to +250° F (-40° to 121.1° C)

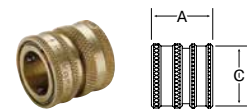

### High Flow Coupler 1163-60-BPD

PART NO.	BODY SIZE	THREAD SIZE NH	A	C
1163-60-BPD	3/4	3/4-11 1/2	1.12	1.21

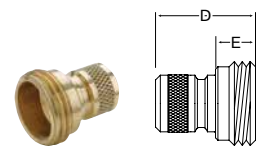

### High Flow Nipple 1163-61-BPD

PART NO.	BODY SIZE	THREAD SIZE NH	D	E
1163-61-BPD	3/4	3/4-11 1/2	1.25	.5

**WARNING** These products can expose you to chemicals including CARBON BLACK, or LEAD, which are known to the state of California to cause cancer, and LEAD which is known to cause birth defects or other reproductive harm. For more information go to [www.P65Warnings.ca.gov](http://www.P65Warnings.ca.gov).





# Industrial Valves

Standard Ball Valves

Carbon Steel Ball Valves

Mini Ball Valves

Polypropylene Ball Valves:  
LIQUIfit, TrueSeal, and  
Par-Barb

Axial Valves

Replacement Componentry

Ball Valve Stem Extensions  
Series STX

Needle Valves

Drain Cocks/  
Ground Plug Shutoff







**Female Ports**

**V500P**

Female-Female  
p. K8



**V502P**

Panel Mount  
p. K14



**V520P**

Economy Series  
p. K21



**V525P**

Female-Female  
p. K22



**V533P**

3 Way Diversion  
p. K24



**V540P**

4 Way  
p. K24



**V600P**

6 Port Diversion  
p. K29



**V633P**

6 Port Diversion  
p. K29



**V500CS**

Carbon Steel  
p. K31



**V502CS**

Panel Mount  
Carbon Steel  
p. K31



**V502SS**

Panel Mount  
Stainless  
p. K39



**MV709**

Micro Valve  
p. K40



**MV200**

Mini Valve  
p. K42



**MV609**

Mini Valve  
p. K42



**PV609**

Plug Valve  
p. K50



**4203**

Axial Valve-NPT  
p. K60



**4202**

Axial Valve-BSP  
p. K60



**Male – Male Ports**

**V591P**

90° Valve  
p. K26



**V591P-X-04**

90° Valve  
p. K26



**PV607**

Plug Valve  
p. K50



**Male – Female Compact High Pressure**

**XV501PCHP**

p. K12



**Male-Female Ports**

**V501P**

Male-Female  
p. K11



**V590P**

90° Valve  
p. K26



**V590P-X-04**

90° Valve  
p. K26



**V501SS**

Stainless Steel  
p. K37



**MV708**

Micro Valve  
p. K40



**MV608**

Mini Valve  
p. K42



**PV608**

Plug Valve  
p. K50



**Barb to Female Port**

**V500P-HB**

Barb to Female Port  
p. K27



**Solder Ports**

**V509P**

Solder - Solder  
p. K17



**Straight Thread Ports**

**V506P**

Female - Female  
p. K16



**V510P**

Male - Female  
p. K19



**V506CS**

Carbon Steel  
p. K33



**Female Ports – High Pressure**

**V500HP**

Female Ports  
p. K35



**VP500HP**

Female Ports-  
Padlocking  
p. K35



**Straight Thread Ports – High Pressure**

**V506HP**

Female Ports  
p. K36



**VP506HP**

Female Ports-  
Padlocking  
p. K36



**WARNING** These products can expose you to chemicals including NICKEL, CARBON BLACK, or LEAD, which are known to the state of California to cause cancer, and LEAD which is known to cause birth defects or other reproductive harm. For more information go to [www.P65Warnings.ca.gov](http://www.P65Warnings.ca.gov).



**Padlocking**

**VP500P**

Female Ports  
p. K8



**VP501P**

Male - Female  
p. K12



**VP502P**

Panel Mount  
p. K14



**VP510P**

Straight Thread  
p. K19



**VP520P**

p. K21



**VP500CS**

Carbon Steel  
p. K31



**VP502CS**

Panel Mount  
p. K31



**VP502SS**

Stainless Steel  
p. K39



**Tee Handle**

**V500P-X-04**

Female Ports  
p. K9



**V501P-X-04**

Male - Female  
p. K12



**V502P-X-04**

Panel Mount  
p. K14



**V510P-X-04**

Straight Thread  
p. K19



**V500CS-X-04**

Carbon Steel  
p. K31



**Oval Handle**

**V500P-X-21**

Female Ports  
p. K9



**V501P-X-21**

Male - Female  
p. K12



**V502P-X-21**

Panel Mount  
p. K14



**V510P-X-21**

Straight Thread  
p. K19



**V500CS-X-21**

Carbon Steel  
p. K32



**V502CS-X-21**

Panel Mount -  
Carbon Steel  
p. K32



**V502SS-X-21**

Oval Handle  
p. K39



**Short Handle**

**V502SS-X-20**

Panel Mount  
p. K39



**Metric Female Ports**

**BVGL**

Female Ports Long  
p. K55



**BVGTL**

Female Ports Long  
p. K55



**Metric Padlocking**

**BVG4PLOCK**

Female Ports  
p. K57



**Vented**

**VV500P**

Female Ports  
p. K8



**VV501P**

Male-Female  
p. K12



**VV502P**

Panel Mount  
p. K14



**Vented – Padlocking**

**VVP500P**

Female Ports  
p. K8



**VVP501P**

Male-Female  
p. K12



**VVP502P**

Panel Mount  
p. K14



**WARNING** These products can expose you to chemicals including NICKEL, CARBON BLACK, or LEAD, which are known to the state of California to cause cancer, and LEAD which is known to cause birth defects or other reproductive harm. For more information go to [www.P65Warnings.ca.gov](http://www.P65Warnings.ca.gov).



**■ Polypropylene Ball Valves**

**VME**  
Male Elbow  
p. K44



**VFE**  
Female Elbow  
p. K44



**VUC**  
Union Connector  
p. K44



**VEU**  
Elbow Union  
p. K44



**VMC**  
Male Connector  
p. K45



**VFC**  
Female Connector  
p. K45



**VUCPB**  
Union Connector  
p. K45



**VAS**  
Angle Stop  
p. K45



**VME**  
Male Elbow  
p. K45



**VFE**  
Female Elbow  
p. K45



**VUC**  
Union Connector  
p. K46



**VEU**  
Elbow Union  
p. K46



**VTEU**  
Tube Elbow Union  
p. K46



**VFC**  
Female Connector  
p. K46



**VMC**  
Male Connector  
p. K46



**VEU**  
Parbarb Elbow Ball  
Valve  
p. K46



**VFE**  
Barbed Female  
Elbow  
p. K47



**VME**  
Barbed Male Elbow  
p. K47



**VFC**  
Barbed Female  
Connector  
p. K47



**VMC**  
Barbed Male  
Connector  
p. K47



**VUC**  
Barbed Union  
Connector  
p. K47



**VUCPB**  
Union Connector  
Barbed x Tube  
p. K47



**BVC**  
Ball Valve Clip  
p. K47



**VUC**  
Valve Union  
Connector  
p. K48



**VMC**  
Valve Male  
Connector  
p. K48



**VFC**  
Valve Female  
Connector  
p. K48



**VFE**  
Valve Female  
Elbow  
p. K48



**VME**  
Valve Male Elbow  
p. K48



**VEU**  
Valve Elbow Union  
p. K48



**■ Needle Valves**

**NV101F**  
Female - Male  
p. K65



**NV102F**  
Flare  
p. K65



**NV103F**  
Flare - Male Pipe  
p. K65



**HV104C**  
Humidifier Valve  
p. K65



**NV107P**  
Pipe  
p. K66



**NV108P**  
Female - Male  
p. K66



**NV109P**  
Female  
p. K66



**NV311P**  
Poly-Tite  
p. K66



**NV312P**  
Poly-Tite  
p. K66



**NV104C-NV104CA**  
Compression - Pipe  
p. K65



**NV105C-NV105CA**  
Compression  
p. K65



**NV106C-NV106CA**  
Compression - Pipe  
p. K66



**WARNING** These products can expose you to chemicals including NICKEL, CARBON BLACK, or LEAD, which are known to the state of California to cause cancer, and LEAD which is known to cause birth defects or other reproductive harm. For more information go to [www.P65Warnings.ca.gov](http://www.P65Warnings.ca.gov).

■ **Shutoff Valves**

**V203F**  
Flare  
p. K68



**V204F**  
Flare - Pipe  
p. K68



**V401P**  
Pipe  
p. K68



**V402P**  
Female - Pipe  
p. K68



**V403P**  
Female  
p. K68



**V406P**  
3 Way  
p. K68



**V407P**  
4 Way  
p. K68



**V303C-V303CA**  
Compression  
p. K68



**V304C-V304CA**  
Compression - Pipe  
p. K68



**DC601**  
Pipe  
p. K68



■ **Drain Cocks**

**DCR601**  
Internal Seal  
p. K69



**DC602**  
Internal Seal  
p. K69



**DC603**  
Internal Seal  
p. K69



**DC604**  
External Seal  
p. K69



**DC606**  
External Seal  
p. K69



**DC607**  
Bib Drain  
p. K69



■ **Auxiliary**

**PVMB-001**  
Mounting Bracket  
p. K50



**V502P-X-ACT**  
Actuator  
p. K52



**V502SS-X-ACT**  
Actuator  
p. K52



**V502P-X-SUB**  
Sub-Assembly  
p. K53



**V502SS-X-SUB**  
Sub-Assembly  
p. K53



**ACT-P-X-KIT**  
Brass Actuator Kit  
p. K53



**ACT-SS-X-KIT**  
Stainless Actuator  
Kit  
p. K53



**STX-P**  
Stem Extension  
p. K63



**HV104C-KIT**  
Humidifier Valve Kit  
p. K65



**SPV104C-KIT**  
Self Piercing Kit  
p. K65



**WARNING** These products can expose you to chemicals including NICKEL, CARBON BLACK, or LEAD, which are known to the state of California to cause cancer, and LEAD which is known to cause birth defects or other reproductive harm. For more information go to [www.P65Warnings.ca.gov](http://www.P65Warnings.ca.gov).



- A
- B
- C
- D
- E
- F
- G
- H
- I
- J
- K
- L
- M
- N
- O

A  
B  
C  
D  
E  
F  
G  
H  
I  
J  
K  
L  
M  
N  
O



# Ball Valves Brass Series 500

Parker's industrial ball valves are intended for general purpose use. Ball valves are intended for use in the fully open or closed positions. Throttling of the valve may result in premature seal failure and/or inability to turn the valve handle.

### Product Features:

- Forged brass body
- Chrome plated brass ball
- PTFE seats/seals
- Steel handle

### Style:

- V-Valve
- VP-Valve, padlocking handle
- VV-Valve, vented
- VVP-Valve, vented, padlocking handle

### Type:

- 500-Female/Female PTF ports

### Material:

- P-Brass
- PN-Nickel plated

### Options:

- 01-Stainless Steel Ball & Stem
- 02-Stainless Steel Handle & Nut
- 03-Stainless Steel Ball, Stem, Handle & Nut
- 04-Tee Handle
- 08-Unmarked yellow vinyl handle cover
- 21-Oval Handle

### Specifications:

#### Pressure Range:

- 600 WOG , Cold Non-shock
- Saturated Steam up to 150 PSI (10.3 bar)
- Vacuum Service to 29 Inches Hg
- Vented up to 250 PSI (17.2 bar)

#### Temperature Range

- 0° to +350° F (-17.7° to +176.6° C)

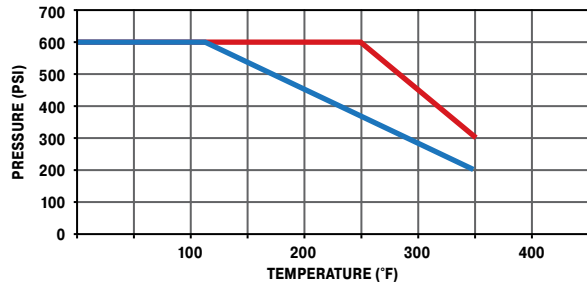

- 1/4" to 1"
- 1 1/4" to 2"

FLOW DATA	
VALVE SIZE	CV
1/4	4.0
3/8	5.8
1/2	12.0
3/4	25.0
1	35.0
1-1/4*	57.0
1-1/2*	92.0
2*	224.0

\*For these part numbers only the \* options are available.

**WARNING** These products can expose you to chemicals including NICKEL or LEAD, which are known to the state of California to cause cancer, and LEAD which is known to cause birth defects or other reproductive harm. For more information go to [www.P65Warnings.ca.gov](http://www.P65Warnings.ca.gov).



Click here for CADs, Product Specifications or to Configure Parts Online

### Female-Female Pipe Ends V500P

PART NO.	PIPE THREAD [PTF]	B HEX	C HEX	H	L	M	N	FLOW DIA. D
V500P-4	1/4	15/16	15/16	3.96	4.90	2.03	2.47	.375
V500P-6	3/8	15/16	15/16	3.96	4.90	2.03	2.47	.375
V500P-8	1/2*	1-1/16	1-1/16	3.96	5.00	2.20	2.58	.500
V500P-12	3/4**	1-1/4	1-5/16	3.96	5.25	2.42	2.81	.685
V500P-16	1**	1-1/2	1-9/16	3.96	5.34	2.75	3.08	.875

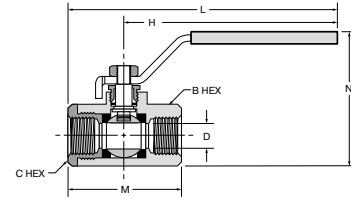

### Female-Female Pipe Ends V500P-20, V500P-24, V500P-32

PART NO.	PIPE THREAD [NPT]	OCTAGON	H	L	M	N	FLOW DIA. D
V500P-20	1-1/4	1.93	6.22	8.05	3.66	3.01	1.18
V500P-24	1-1/2	2.13	6.22	8.23	4.02	3.25	1.50
V500P-32	2	2.69	6.22	8.58	4.76	3.52	1.89

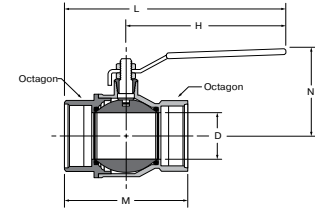

### Vented, Female Pipe Ends VV500P

PART NO.	PIPE THREAD [PTF]	B HEX	C HEX	K	H	L	M	N	D FLOW Ø
VV500P-4	1/4	15/16	15/16	1.11	3.96	4.90	2.03	2.47	.375
VV500P-6	3/8	15/16	15/16	1.11	3.96	4.90	2.03	2.47	.375
VV500P-8	1/2*	1-1/16	1-1/16	1.23	3.96	5.00	2.20	2.58	.500
VV500P-12	3/4**	1-1/4	1-5/16	1.45	3.96	5.25	2.42	2.81	.685
VV500P-16	1**	1-1/2	1-9/16	1.58	3.96	5.34	2.75	3.08	.875

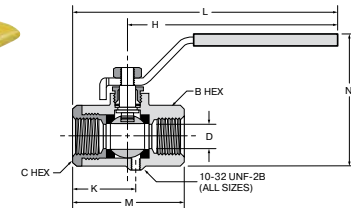

### Locking Handle, Female Pipe Ends VP500P

PART NO.	PIPE THREAD [PTF]	B HEX	C HEX	H	L	M	N	D FLOW Ø
VP500P-4	1/4	15/16	15/16	3.96	4.90	2.03	2.47	.375
VP500P-6	3/8	15/16	15/16	3.96	4.90	2.03	2.47	.375
VP500P-8	1/2*	1-1/16	1-1/16	3.96	5.00	2.20	2.58	.500
VP500P-12	3/4**	1-1/4	1-5/16	3.96	5.25	2.42	2.81	.685
VP500P-16	1**	1-1/2	1-9/16	3.96	5.34	2.75	3.08	.875
FOR USE WITH 5/16" Ø SHANK LOCK; .33Ø								
VP500P-20	1-1/4	1-15/16	1-15/16	6.22	8.05	3.66	4.04	1.180
VP500P-24	1-1/2	2-1/8	2-1/8	6.22	8.23	4.02	4.52	1.500
VP500P-32	2	2-11/16	2-11/16	6.22	8.60	4.76	5.07	1.890
FOR USE WITH 9/32" Ø SHANK LOCK; .31Ø								

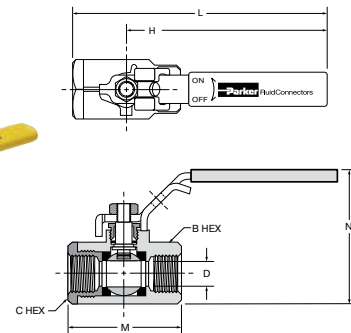

### OSHA 29 CFR Part 1910 Vented, Locking Handle, Female Pipe Ends VVP500P

PART NO.	PIPE THD [PTF]	B HEX	C HEX	K	H	L	M	N	D FLOW Ø
VVP500P-4	1/4	15/16	15/16	1.11	3.96	4.90	2.03	2.47	.375
VVP500P-6	3/8	15/16	15/16	1.11	3.96	4.90	2.03	2.47	.375
VVP500P-8	1/2*	1-1/16	1-1/16	1.23	3.96	5.00	2.20	2.58	.500
VVP500P-12	3/4**	1-1/4	1-5/16	1.45	3.96	5.25	2.42	2.81	.685
VVP500P-16	1**	1-1/2	1-9/16	1.58	3.96	5.34	2.75	3.08	.875
FOR USE WITH 5/16" Ø SHANK LOCK									

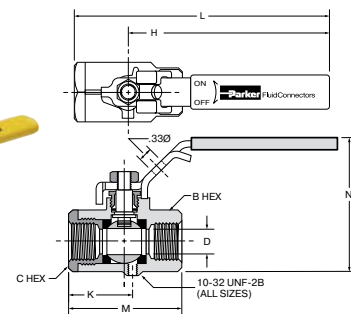

\*PTF Special Short. \*\*PTF SPL Extra Short

**WARNING** These products can expose you to chemicals including NICKEL or LEAD, which are known to the state of California to cause cancer, and LEAD which is known to cause birth defects or other reproductive harm. For more information go to [www.P65Warnings.ca.gov](http://www.P65Warnings.ca.gov).



- A
- B
- C
- D
- E
- F
- G
- H
- I
- J
- K
- L
- M
- N
- O

Click here for CADs, Product Specifications or to Configure Parts Online

### Tee Handle, Female Pipe Ends V500P-X-04

PART NO.	PIPE THREAD [PTF]	B HEX	C HEX	H	L	M	N	D FLOW Ø
V500P-4-04	1/4	15/16	15/16	1.25	2.50	2.03	1.87	.375
V500P-6-04	3/8	15/16	15/16	1.25	2.50	2.03	1.87	.375
V500P-8-04	1/2*	1-1/16	1-1/16	1.25	2.50	2.20	1.98	.500
V500P-12-04	3/4**	1-1/4	1-5/16	1.25	2.50	2.42	2.20	.685
V500P-16-04	1**	1-1/2	1-9/16	1.25	2.50	2.75	2.48	.875

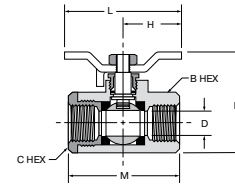

### Oval Handle, Female Pipe Ends V500P-X-21

PART NO.	PIPE THREAD [PTF]	B HEX	C HEX	H	L	M	N	D FLOW Ø
V500P-4-21	1/4	15/16	15/16	1.74	3.49	2.03	2.38	.375
V500P-6-21	3/8	15/16	15/16	1.74	3.49	2.03	2.38	.375
V500P-8-21	1/2*	1-1/16	1-1/16	1.74	3.49	2.20	2.49	.500
V500P-12-21	3/4**	1-1/4	1-5/16	1.74	3.48	2.42	2.71	.685
V500P-16-21	1**	1-1/2	1-9/16	1.74	3.48	2.75	2.99	.875

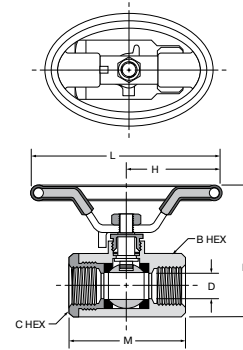

\*PTF Special Short. \*\*PTF SPL Extra Short

**WARNING** These products can expose you to chemicals including NICKEL or LEAD, which are known to the state of California to cause cancer, and LEAD which is known to cause birth defects or other reproductive harm. For more information go to [www.P65Warnings.ca.gov](http://www.P65Warnings.ca.gov).





# Ball Valves Brass Series 501



## Product Features:

- Forged brass body
- Chrome plated brass ball
- PTFE seats/seals
- Steel handle

## Style:

- V-Valve
- VP-Valve, padlocking handle
- VV-Valve, vented
- VVP-Valve, vented, padlocking handle

## Type:

- 501-Male/Female PTF ports

## Material:

- P-Brass
- PN-Nickel plated

## Options:

- 01-Stainless Steel Ball & Stem
- 02-Stainless Steel Handle & Nut
- 03-Stainless Steel Ball, Stem, Handle & Nut
- 04-Tee Handle
- 08-Unmarked yellow vinyl handle cover
- 21-Oval Handle

## Pressure Range:

- 600 WOG , Cold Non-shock
- Saturated Steam up to 150 PSI (10.3 bar)
- Vacuum Service to 29 Inches Hg
- Vented up to 250 PSI (17.2 bar)
- XV501PCHP up to 2000PSI (137.8 bar)

## Temperature Range

- 0° to +350° F (-17.7° to +176.6° C)

## Flow Data

VALVE SIZE	CV	VALVE SIZE	CV
1/4	6.3	3/4	25.0
3/8	5.7	1	35.0
1/2	10.0		

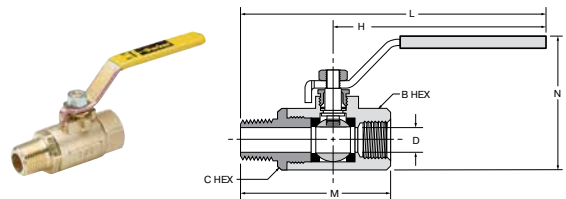
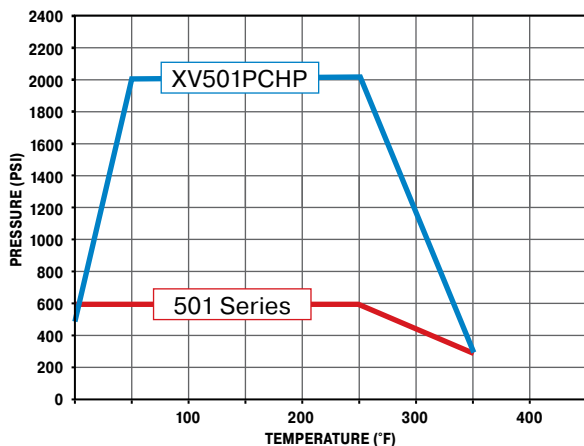

## Male-Female Pipe Ends V501P

PART NO.	FEMALE PIPE THRD [PTF]	MALE PIPE THRD [NPTF]	B HEX	C HEX	H	L	M	N	D FLOW Ø
V501P-4	1/4	1/4	15/16	15/16	3.96	5.46	2.59	2.47	.344
V501P-6	3/8	3/8	15/16	15/16	3.96	5.46	2.59	2.47	.375
V501P-8	1/2*	1/2	1-1/16	1-1/16	3.96	5.75	2.94	2.58	.500
V501P-12	3/4**	3/4*	1-1/4	1-5/16	3.96	5.83	3.00	2.81	.685
V501P-16	1**	1*	1-1/2	1-9/16	3.96	6.19	3.60	3.08	.875

\*PTF Special Short. \*\*PTF SPL Extra Short

**WARNING** These products can expose you to chemicals including NICKEL or LEAD, which are known to the state of California to cause cancer, and LEAD which is known to cause birth defects or other reproductive harm. For more information go to [www.P65Warnings.ca.gov](http://www.P65Warnings.ca.gov).



Click here for CADs, Product Specifications or to Configure Parts Online

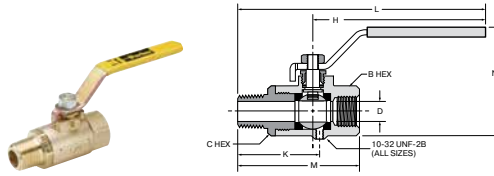

Vented, Male-Female Pipe Ends VV501P

PART NO.	FEMALE PIPE THRD [PTF]	MALE PIPE THRD [NPTF]	B HEX	C HEX	K	H	L	M	N	D FLOW Ø
VV501P-4	1/4	1/4	15/16	15/16	1.67	3.96	5.46	2.59	2.47	.344
VV501P-6	3/8	3/8	15/16	15/16	1.67	3.96	5.46	2.59	2.47	.375
VV501P-8	1/2*	1/2	1-1/16	1-1/16	1.98	3.96	5.75	2.95	2.58	.500
VV501P-12	3/4**	3/4*	1-1/4	1-5/16	2.03	3.96	5.83	3.00	2.81	.685
VV501P-16	1**	1*	1-1/2	1-9/16	2.43	3.96	6.19	3.60	3.08	.875

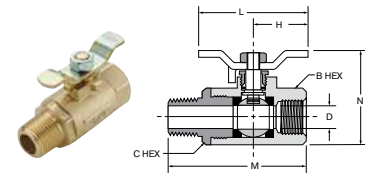

Tee Handle, Male-Female Pipe Ends V501P-X-04

PART NO.	FEMALE PIPE THRD [PTF]	MALE PIPE THRD [NPTF]	B HEX	C HEX	H	L	M	N	D FLOW Ø
V501P-4-04	1/4	1/4	15/16	15/16	1.25	2.50	2.59	1.87	.344
V501P-6-04	3/8	3/8	15/16	15/16	1.25	2.50	2.59	1.87	.375
V501P-8-04	1/2*	1/2	1-1/16	1-1/16	1.25	2.50	2.95	1.98	.500
V501P-12-04	3/4**	3/4	1-1/4	1-5/16	1.25	2.50	3.00	2.20	.685
V501P-16-04	1**	1	1-1/2	1-9/16	1.25	2.50	3.60	2.48	.875

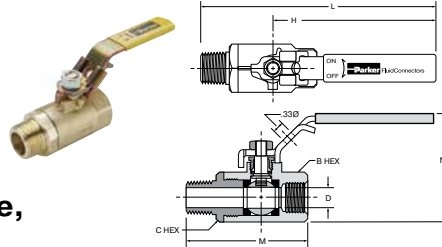

Locking Handle, Male-Female Pipe Ends VP501P

PART NO.	FEMALE PIPE THRD [PTF]	MALE PIPE THRD [NPTF]	B HEX	C HEX	H	L	M	N	D FLOW Ø
VP501P-4	1/4	1/4	15/16	15/16	3.96	5.46	2.59	2.47	.344
VP501P-6	3/8	3/8	15/16	15/16	3.96	5.46	2.59	2.47	.375
VP501P-8	1/2*	1/2	1-1/16	1-1/16	3.96	5.75	2.95	2.58	.500
VP501P-12	3/4**	3/4*	1-1/4	1-5/16	3.96	5.83	3.00	2.81	.685
VP501P-16	1**	1*	1-1/2	1-9/16	3.96	6.19	3.60	3.08	.875

For use with 5/16" Ø shank lock

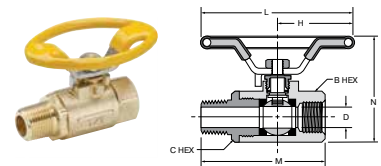

Oval Handle, Male-Female Pipe Ends V501P-X-21

PART NO.	FEMALE PIPE THRD [PTF]	MALE PIPE THRD [NPTF]	B HEX	C HEX	H	L	M	N	D FLOW Ø
V501P-4-21	1/4	1/4	15/16	15/16	1.74	3.49	2.59	2.38	.344
V501P-6-21	3/8	3/8	15/16	15/16	1.74	3.49	2.59	2.38	.375
V501P-8-21	1/2*	1/2	1-1/16	1-1/16	1.74	3.49	2.95	2.49	.500
V501P-12-21	3/4**	3/4	1-1/4	1-5/16	1.74	3.48	3.00	2.71	.685
V501P-16-21	1**	1	1-1/2	1-9/16	1.74	3.48	3.60	2.99	.875

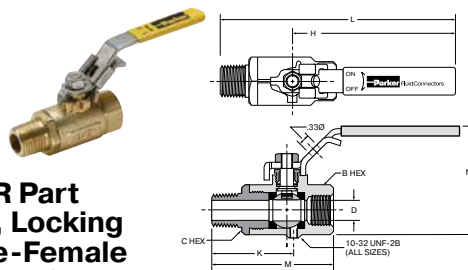

OSHA 29 CFR Part 1910 Vented, Locking Handle, Male-Female Pipe Ends VVP501P

PART NO.	FEMALE PIPE THRD [PTF]	MALE PIPE THRD [NPTF]	B HEX	C HEX	K	H	L	M	N	D FLOW Ø
VVP501P-4	1/4	1/4	15/16	15/16	1.67	3.96	5.46	2.59	2.47	.344
VVP501P-6	3/8	3/8	15/16	15/16	1.67	3.96	5.46	2.59	2.47	.375
VVP501P-8	1/2*	1/2	1-1/16	1-1/16	1.98	3.96	5.75	2.95	2.58	.500
VVP501P-12	3/4**	3/4	1-1/4	1-5/16	2.03	3.96	5.83	3.00	2.81	.685
VVP501P-16	1**	1	1-1/2	1-9/16	2.43	3.96	6.19	3.60	3.08	.875

For use with 5/16" Ø shank lock

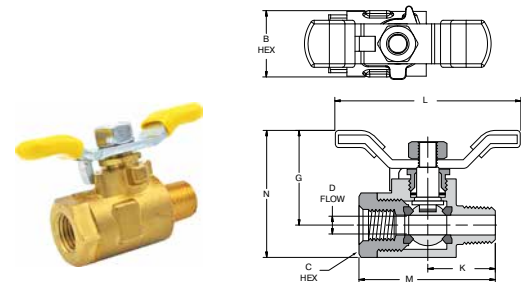

Compact High Pressure XV501PCHP

PART NO.	FEMALE PIPE THRD [PTF]	MALE PIPE THRD [NPTF]	B HEX	C HEX	G	K	L	M	N	D FLOW Ø
XV501PCHP-4	1/4	1/4	15/16	13/16	1.33	.95	2.62	1.92	1.79	.25

\*PTF Special Short. \*\*PTF SPL Extra Short

**WARNING** These products can expose you to chemicals including NICKEL or LEAD, which are known to the state of California to cause cancer, and LEAD which is known to cause birth defects or other reproductive harm. For more information go to www.P65Warnings.ca.gov.



# Ball Valves Brass Series 502



## Product Features:

- Forged brass body
- Chrome plated brass ball
- PTFE seats/seals
- Steel handle

## Style:

- V-Valve
- VP-Valve, padlocking handle
- VV-Valve, vented
- VVP-Valve, vented, padlocking handle

## Type:

- 502-Female/Female PTF ports

## Material:

- P-Brass
- PN-Nickel plated

## Options:

- 01-Stainless Steel Ball & Stem
- 02-Stainless Steel Handle & Nut
- 03-Stainless Steel Ball, Stem, Handle & Nut
- 04-Tee Handle
- 08-Unmarked yellow vinyl handle cover
- 21-Oval Handle

## Specifications:

### Pressure Range:

- 600 WOG , Cold Non-shock
- Saturated Steam up to 150 PSI (10.3 bar)
- Vacuum Service to 29 Inches Hg
- Vented up to 250 PSI (17.2 bar)

### Temperature Range

- 0° to +350° F (-17.7° to +176.6° C)

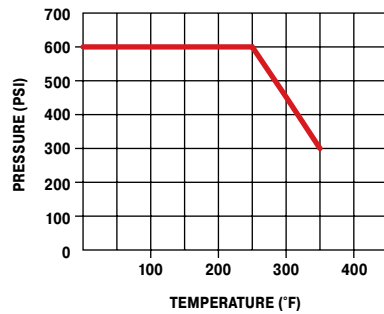

FLOW DATA	
VALVE SIZE	CV
1/4	4.0
3/8	5.8
1/2	12.0
3/4	25.0
1	35.0

## Mounting detail for all sizes

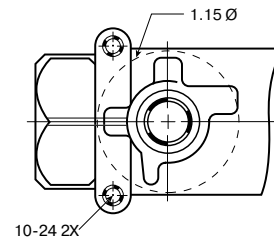

**WARNING** These products can expose you to chemicals including NICKEL or LEAD, which are known to the state of California to cause cancer, and LEAD which is known to cause birth defects or other reproductive harm. For more information go to [www.P65Warnings.ca.gov](http://www.P65Warnings.ca.gov).



A

B

C

D

E

F

G

H

I

J

K

L

M

N

O

Click here for CADs, Product Specifications or to Configure Parts Online

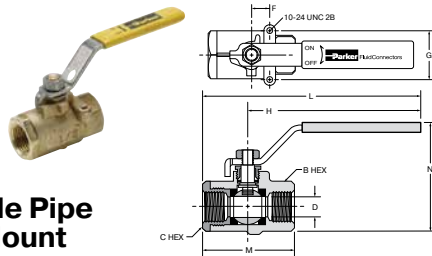

**Female-Female Pipe Ends, Panel Mount V502P**

PART NO.	PIPE THD. [PTF]	B HEX	C HEX	F	G	H	L	M	N	FLOW DIA. D
V502P-4	1/4	15/16	15/16	.50	1.12	3.96	4.90	2.03	2.47	.375
V502P-6	3/8	15/16	15/16	.50	1.12	3.96	4.90	2.03	2.47	.375
V502P-8	1/2*	1-1/16	1-1/16	.50	1.12	3.96	5.06	2.20	2.58	.500
V502P-12	3/4**	1-1/4	1-5/16	.87	1.37	3.96	5.25	2.42	2.81	.685
V502P-16	1**	1-1/2	1-9/16	.87	1.37	3.96	5.34	2.75	3.08	.875

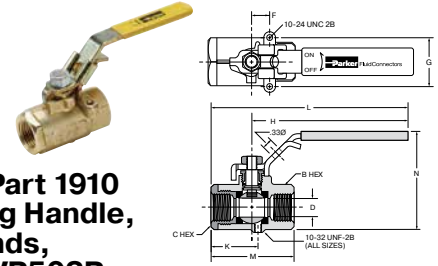

**OSHA 29 CFR Part 1910 Vented, Locking Handle, Female Pipe Ends, Panel Mount VVP502P**

PART NO.	PIPE THD. [PTF]	B HEX	C HEX	F	G	K	H	L	M	N	D FLOW Ø
VVP502P-4	1/4	15/16	15/16	.50	1.12	1.11	3.96	4.90	2.03	2.47	.375
VVP502P-6	3/8	15/16	15/16	.50	1.12	1.11	3.96	4.90	2.03	2.47	.375
VVP502P-8	1/2*	1-1/16	1-1/16	.50	1.12	1.23	3.96	5.06	2.20	2.58	.500
VVP502P-12	3/4**	1-1/4	1-5/16	.87	1.37	1.45	3.96	5.25	2.42	2.81	.685
VVP502P-16	1**	1-1/2	1-9/16	.87	1.37	1.58	3.96	5.34	2.75	3.08	.875

For use with 5/16" Ø shank lock

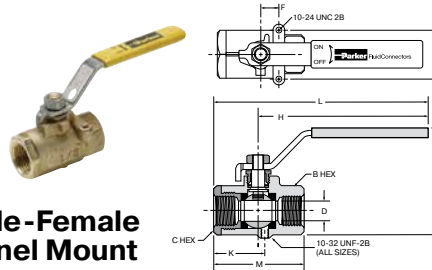

**Vented, Female-Female Pipe Ends, Panel Mount VV502P**

PART NO.	PIPE THD. [PTF]	B HEX	C HEX	F	G	K	H	L	M	N	D FLOW Ø
VV502P-4	1/4	15/16	15/16	.50	1.12	1.11	3.96	4.90	2.03	2.47	.375
VV502P-6	3/8	15/16	15/16	.50	1.12	1.11	3.96	4.90	2.03	2.47	.375
VV502P-8	1/2*	1-1/16	1-1/16	.50	1.12	1.23	3.96	5.06	2.20	2.58	.500
VV502P-12	3/4**	1-1/4	1-5/16	.87	1.37	1.45	3.96	5.25	2.42	2.81	.685
VV502P-16	1**	1-1/2	1-9/16	.87	1.37	1.58	3.96	5.34	2.75	3.08	.875

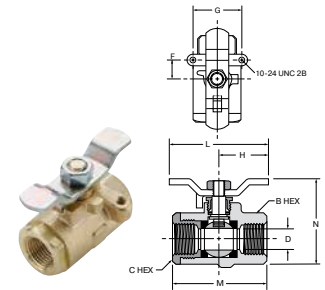

**Tee Handle, Female Pipe Ends, Panel Mount V502P-X-04**

PART NO.	PIPE THD. [PTF]	B HEX	C HEX	F	G	H	L	M	N	D FLOW Ø
V502P-4-04	1/4	15/16	15/16	.50	1.12	1.25	2.50	2.03	1.87	.375
V502P-6-04	3/8	15/16	15/16	.50	1.12	1.25	2.50	2.03	1.87	.375
V502P-8-04	1/2*	1-1/16	1-1/16	.50	1.12	1.25	2.50	2.20	1.98	.500
V502P-12-04	3/4**	1-1/4	1-5/16	.87	1.37	1.25	2.50	2.42	2.20	.685
V502P-16-04	1**	1-1/2	1-9/16	.87	1.37	1.25	2.50	2.75	2.48	.875

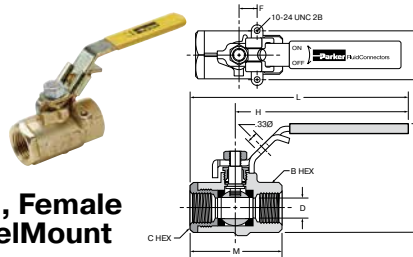

**Locking Handle, Female Pipe Ends, Panel Mount VP502P**

PART NO.	PIPE THD. [PTF]	B HEX	C HEX	F	G	H	L	M	N	D FLOW Ø
VP502P-4	1/4	15/16	15/16	.50	1.12	3.96	4.90	2.03	2.47	.375
VP502P-6	3/8	15/16	15/16	.50	1.12	3.96	4.90	2.03	2.47	.375
VP502P-8	1/2*	1-1/16	1-1/16	.50	1.12	3.96	5.06	2.20	2.58	.500
VP502P-12	3/4**	1-1/4	1-5/16	.87	1.37	3.96	5.25	2.42	2.81	.685
VP502P-16	1**	1-1/2	1-9/16	.87	1.37	3.96	5.34	2.75	3.08	.875

For use with 5/16" Ø shank lock

\*PTF Special Short. \*\*PTF SPL Extra Short

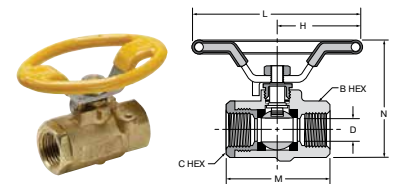

**Oval Handle, Female Pipe Ends, Panel Mount V502P-X-21**

PART NO.	PIPE THD. [PTF]	B HEX	C HEX	H	L	M	N	D FLOW Ø
V502P-4-21	1/4	15/16	15/16	1.74	3.49	2.03	2.38	.375
V502P-6-21	3/8	15/16	15/16	1.74	3.49	2.03	2.38	.375
V502P-8-21	1/2*	1-1/16	1-1/16	1.74	3.49	2.20	2.49	.500
V502P-12-21	3/4**	1-1/4	1-5/16	1.74	3.48	2.42	2.71	.685
V502P-16-21	1**	1-1/2	1-9/16	1.74	3.48	2.75	2.99	.875

**WARNING** These products can expose you to chemicals including NICKEL or LEAD, which are known to the state of California to cause cancer, and LEAD which is known to cause birth defects or other reproductive harm. For more information go to www.P65Warnings.ca.gov.



# Ball Valve Brass Series 506



## Product Features:

- Forged brass body
- Chrome plated brass ball
- PTFE seats/seals
- Steel handle

## Style:

- V-Valve
- VP-Valve, padlocking handle

## Type:

- 506-Female/Female SAE J1926-1 Ports

## Material:

- P-Brass
- PN-Nickel plated

## Options:

- 01-Stainless Steel Ball & Stem
- 02-Stainless Steel Handle & Nut
- 03-Stainless Steel Ball, Stem, Handle & Nut
- 04-Tee Handle
- 08-Unmarked yellow vinyl handle cover
- 21-Oval Handle

## Specifications:

### Pressure Range:

- 600 WOG , Cold Non-shock
- Saturated Steam up to 150 PSI (10.3 bar)
- Vacuum Service to 29 Inches Hg

### Temperature Range

- 0° to +350° F (-17.7° to +176.6° C)

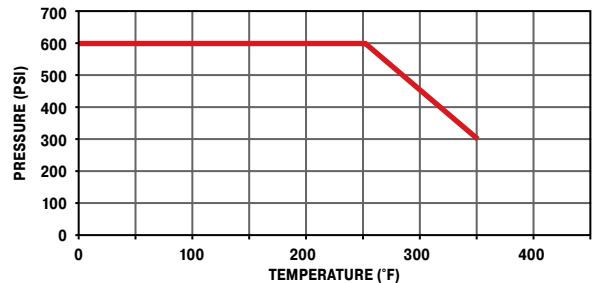

**WARNING** These products can expose you to chemicals including NICKEL or LEAD, which are known to the state of California to cause cancer, and LEAD which is known to cause birth defects or other reproductive harm. For more information go to [www.P65Warnings.ca.gov](http://www.P65Warnings.ca.gov).



A

B

C

D

E

F

G

H

I

J

K

L

M

N

O

[Click here for CADs, Product Specifications or to Configure Parts Online](#)

### Female/Female, Straight Thread O-Ring Port V506P

PART NO.	STRT. THREAD	B HEX	C HEX	H	L	M	N	D FLOW Ø
V506P-4	7/16-20	15/16	15/16	3.96	5.01	2.20	2.47	.375
V506P-6	9/16-18	15/16	15/16	3.96	5.07	2.26	2.47	.375
V506P-8	3/4-16	1-1/16	1-1/16	3.96	5.18	2.42	2.60	.500
V506P-12	1-1/16-12	1-1/4	1-5/16	3.96	5.87	3.46	2.81	.685
V506P-16	1-5/16-12	1-1/2	1-9/16	3.96	5.96	3.68	3.08	.875

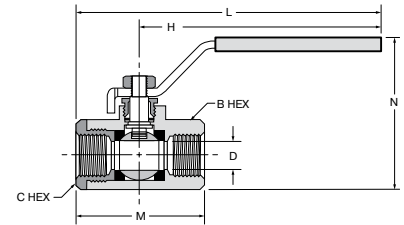

### Female/Female, Straight Thread O-Ring Port V506P-20, V506P-24, V506P-32

PART NO.	STRT. THREAD	B OCT	C OCT	H	L	M	N	D FLOW Ø
V506P-20	1 5/8-12	1.93	1.93	6.22	8.05	3.66	3.01	1.18
V506P-24	1 7/8-12	2.13	2.13	6.22	8.23	4.02	3.25	1.50
V506P-32	2 1/2-12	2.85	2.85	6.22	8.60	4.76	3.52	1.89

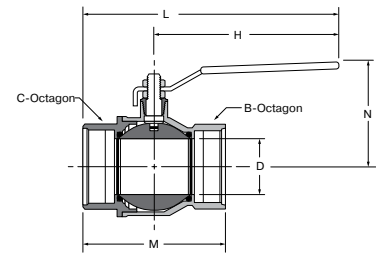

**WARNING** These products can expose you to chemicals including NICKEL or LEAD, which are known to the state of California to cause cancer, and LEAD which is known to cause birth defects or other reproductive harm. For more information go to [www.P65Warnings.ca.gov](http://www.P65Warnings.ca.gov).



# Ball Valves Brass Series 509



## Product Features:

- Forged brass body
- Chrome plated brass ball
- PTFE seats/seals
- Steel handle

## Style:

- V-Valve

## Type:

- 509-Solder Ends

## Material:

- P-Brass

## Specifications:

### Pressure Range:

- 600 WOG , Cold Non-shock
- Saturated Steam up to 150 PSI (10.3 bar)

### Temperature Range

- Nylon: 0° to +350° F (-17.7° to +176.6° C)
- Solder temperature not to exceed 470° F (243.3° C)

## Solder Cup Ends V509P

PART NO.	TUBE SIZE	E	G	H	L	M	N	FLOW DIA. D
V509P-8	1/2	.630	.49	3.94	5.00	2.24	1.69	.55
V509P-12	3/4	.877	.75	4.72	6.10	2.85	1.97	.75
V509P-16	1	1.128	.90	4.72	6.40	3.35	2.13	.94
V509P-20	1 1/4	1.378	.96	6.22	8.13	3.82	3.01	1.18
V509P-24	1 1/2	1.628	1.10	6.22	8.46	4.49	3.25	1.50
V509P-32	2	2.128	1.34	6.22	8.94	5.43	3.52	1.89

FLOW DATA	
VALVE SIZE	CV
1/2"	26
3/4"	69
1"	91
1 1/4"	127
1 1/2"	299
2"	425

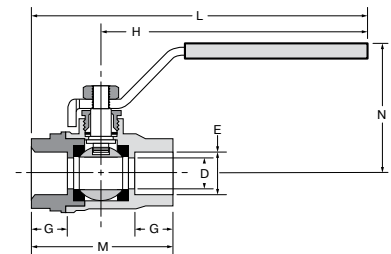

\*For these part numbers only the \* options are available.

A

B

C

D

E

F

G

H

I

J

K

L

M

N

O

A  
B  
C  
D  
E  
F  
G  
H  
I  
J  
K  
L  
M  
N  
O

# Ball Valves Brass Series 510



### Product Features:

- Forged brass body
- Chrome plated brass ball
- PTFE seats/seals
- Steel handle

### Style:

- V-Valve
- VP-Valve, padlocking handle

### Type:

- 510-Male/Female Straight Thread O-ring SAE J1926

### Material:

- P-Brass

### Options:

- 01-Stainless Steel Ball & Stem
- 02-Stainless Steel Handle & Nut
- 03-Stainless Steel Ball, Stem, Handle & Nut
- 04-Tee Handle
- 08-Unmarked yellow vinyl handle cover
- 21-Oval Handle

### Specifications:

#### Pressure Range:

- 600 WOG , Cold Non-shock
- Saturated Steam up to 150 PSI (10.3 bar)
- Vacuum Service to 29 Inches Hg
- Vented up to 250 PSI (17.2 bar)

#### Temperature Range

- 0° to +350° F (-17.7° to +176.6° C)

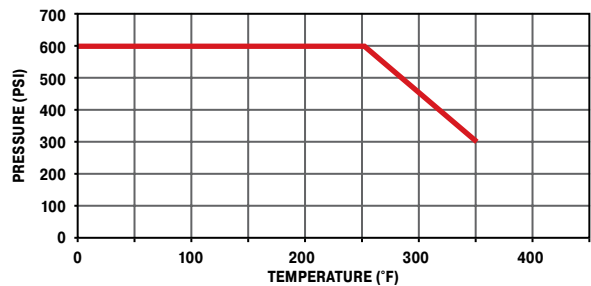

FLOW DATA	
VALVE SIZE	CV
1/4	.8
3/8	2.1
1/2	5.3
5/8	7.6
3/4	13.0
1	33.0

**WARNING** These products can expose you to chemicals including NICKEL or LEAD, which are known to the state of California to cause cancer, and LEAD which is known to cause birth defects or other reproductive harm. For more information go to [www.P65Warnings.ca.gov](http://www.P65Warnings.ca.gov).





Click here for CADs, Product Specifications or to Configure Parts Online

### Male-Female, Straight Thread O-Ring Port V510P

PART NO.	STRT. THREAD	B HEX	C HEX	H	L	M	N	D FLOW Ø
V510P-4	7/16-20	15/16	15/16	3.96	5.61	2.85	2.47	.188
V510P-6	9/16-18	15/16	15/16	3.96	5.68	2.92	2.47	.281
V510P-8	3/4-16	1-1/16	1-1/16	3.96	5.88	3.17	2.58	.422
V510P-10	7/8-14	1-1/4	1-5/16	3.96	6.31	3.90	2.81	.500
V510P-12	1-1/16-12	1-1/4	1-5/16	3.96	6.44	4.03	2.81	.656
V510P-16	1-5/16-12	1-1/2	1-9/16	3.96	6.56	4.28	3.08	.875

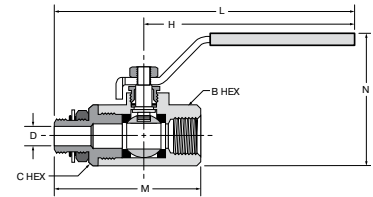

### Locking Handle, Straight Thread O-Ring Port VP510P

PART NO.	STRT. THREAD	B HEX	C HEX	H	L	M	N	D FLOW Ø
VP510P-4	7/16-20	15/16	15/16	3.96	5.61	2.85	2.47	.188
VP510P-6	9/16-18	15/16	15/16	3.96	5.68	2.92	2.47	.281
VP510P-8	3/4-16	1-1/16	1-1/16	3.96	5.88	3.17	2.58	.422
VP510P-10	7/8-14	1-1/4	1-5/16	3.96	6.31	3.90	2.81	.500
VP510P-12	1-1/16-12	1-1/4	1-5/16	3.96	6.44	4.03	2.81	.656

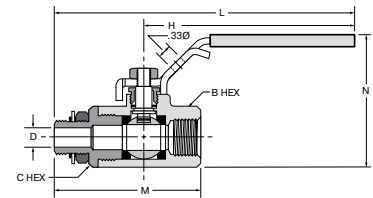

For use with 5/16" Ø shank lock

### Tee Handle, Straight Thread O-Ring Port V510P-X-04

PART NO.	STRT. THREAD	B HEX	C HEX	H	L	M	N	D FLOW Ø
V510P-4-04	7/16-20	15/16	15/16	1.25	2.50	2.85	1.87	.188
V510P-6-04	9/16-18	15/16	15/16	1.25	2.50	2.92	1.87	.281
V510P-8-04	3/4-16	1-1/16	1-1/16	1.25	2.50	3.17	1.98	.422
V510P-10-04	7/8-14	1-1/4	1-5/16	1.25	2.50	3.90	2.20	.500
V510P-12-04	1-1/16-12	1-1/4	1-5/16	1.25	2.50	4.03	2.20	.656
V510P-16-04	1-5/16-12	1-1/2	1-9/16	1.25	2.50	4.28	2.48	.875

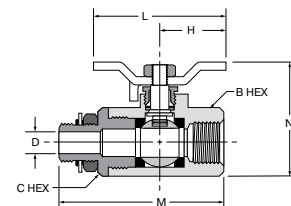

### Oval Handle, Straight Thread O-Ring Port V510P-X-21

PART NO.	STRT. THREAD	B & C HEX	H	L	M	N	D FLOW Ø
V510P-4-21	7/16-20	15/16	1.74	3.49	2.85	2.38	.188
V510P-6-21	9/16-18	15/16	1.74	3.49	2.92	2.38	.281
V510P-8-21	3/4-16	1 1/16	1.74	3.49	3.17	2.49	.422
V510P-12-21	1-1/16-12	1-1/4 (B)	1.75	3.49	4.03	2.71	.656
		1-5/16 (C)					

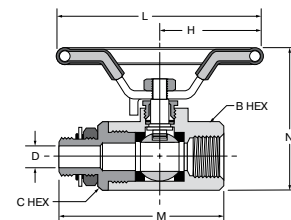

**WARNING** These products can expose you to chemicals including NICKEL or LEAD, which are known to the state of California to cause cancer, and LEAD which is known to cause birth defects or other reproductive harm. For more information go to [www.P65Warnings.ca.gov](http://www.P65Warnings.ca.gov).



- A
- B
- C
- D
- E
- F
- G
- H
- I
- J
- K
- L
- M
- N
- O

A  
B  
C  
D  
E  
F  
G  
H  
I  
J  
K  
L  
M  
N  
O

# Ball Valves Brass Series 520



## Product Features:

- Forged brass body
- Chrome plated brass ball
- PTFE seats/seals
- Fluorocarbon Stem O-rings
- Steel handle

## Style:

- V-Valve
- VP-Valve, padlocking handle

## Type:

- 520-Female/Female NPT Ports

## Material:

- P-Brass

## Options:

- 04-Tee Handle

## Specifications:

### Pressure Range:

- 600 WOG Cold Non-shock 1/4" – 2"
- 450 WOG, Cold Non-shock 2 1/2" – 3"
- Saturated Steam up to 150 PSI (10.3 bar)
- Vacuum Service to 29 Inches Hg

### Temperature Range

- -40° to +350° F (-40° to +176.6° C)

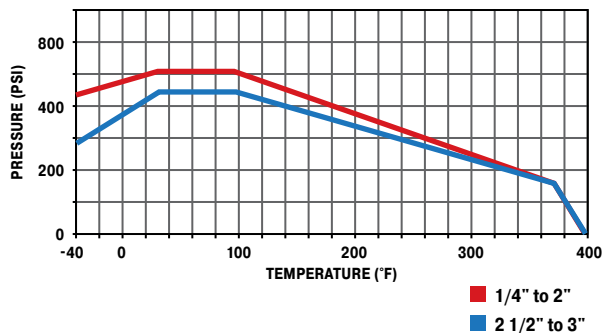

U.L. LISTED	
CATEGORY	
YSDT	LP-GAS SHUT-OFF VALVES
YRBX	FLAMMABLE LIQUID SHUT-OFF VALVES
YRPV	GAS SHUT-OFF VALVES
YQNZ	COMPRESSED GAS SHUT-OFF VALVES

**WARNING** These products can expose you to chemicals including NICKEL or LEAD, which are known to the state of California to cause cancer, and LEAD which is known to cause birth defects or other reproductive harm. For more information go to [www.P65Warnings.ca.gov](http://www.P65Warnings.ca.gov).



[Click here for CADs, Product Specifications or to Configure Parts Online](#)

### Female Pipe Ends V520P

PART NO.	PIPE THREAD [NPT]	B OCTAGON	C OCTAGON	H	L	M	N	D FLOW Ø
V520P-4	1/4-18	.67	.67	3.94	4.83	1.77	1.50	.310
V520P-6	3/8-18	.79	.79	3.94	4.83	1.77	1.50	.400
V520P-8	1/2-14	.98	.98	3.94	5.10	2.32	1.69	.600
V520P-12	3/4-14	1.22	1.22	4.72	5.98	2.52	1.97	.790
V520P-16	1-11.5	1.57	1.57	4.72	6.32	3.19	2.13	1.000
V520P-20	1-1/4	1.93	1.93	6.22	8.05	3.66	2.82	1.180
V520P-24	1-1/2	2.13	2.13	6.22	8.23	4.02	3.06	1.570
V520P-32	2	2.69	2.69	6.22	8.58	4.76	3.33	2.000
V520P-40	2-1/2	3.35	3.35	10.04	13.11	6.14	5.20	2.520
V520P-48	3	3.89	3.89	10.04	13.52	6.97	5.51	3.000

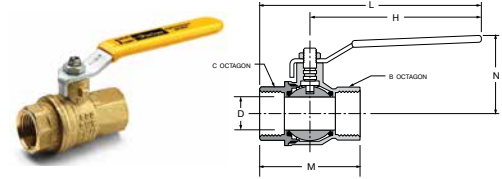

### Locking Handle, Female Pipe Ends VP520P

PART NO.	PIPE THREAD [NPT]	B OCTAGON	C OCTAGON	H	L	M	N	D FLOW Ø
VP520P-4	1/4-18	.67	.67	3.94	4.83	1.77	1.50	.310
VP520P-6	3/8-18	.79	.79	3.94	4.83	1.77	1.50	.400
VP520P-8	1/2-14	.98	.98	3.94	5.10	2.32	1.69	.600
VP520P-12	3/4-14	1.22	1.22	4.72	5.98	2.52	1.97	.790
VP520P-16	1-11.5	1.57	1.57	4.72	6.32	3.19	2.13	1.000
VP520P-20	1-1/4	1.93	1.93	6.22	8.05	3.66	2.82	1.180
VP520P-24	1-1/2	2.13	2.13	6.22	8.23	4.02	3.06	1.570
VP520P-32	2	2.69	2.69	6.22	8.58	4.76	3.33	2.000
VP520P-40	2-1/2	3.35	3.35	10.04	13.11	6.14	5.20	2.520
VP520P-48	3	3.89	3.89	10.04	13.52	6.97	5.51	3.000

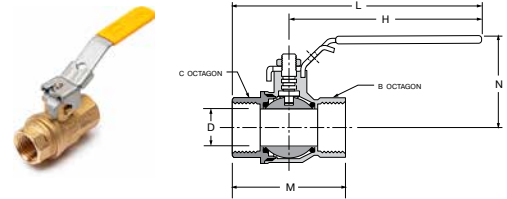

**WARNING** These products can expose you to chemicals including NICKEL or LEAD, which are known to the state of California to cause cancer, and LEAD which is known to cause birth defects or other reproductive harm. For more information go to [www.P65Warnings.ca.gov](http://www.P65Warnings.ca.gov).



- A
- B
- C
- D
- E
- F
- G
- H
- I
- J
- K
- L
- M
- N
- O

A

B

C

D

# Ball Valves Brass Series 525

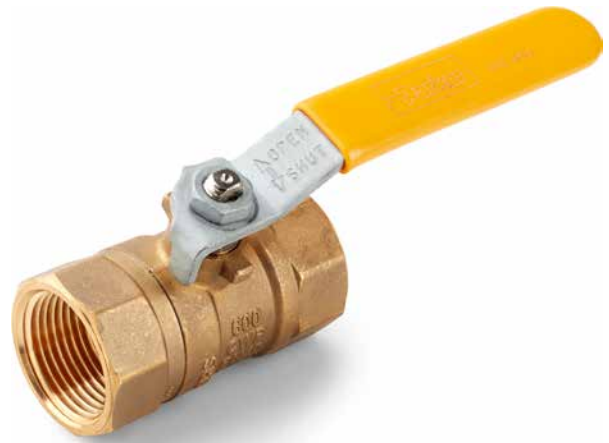

Parker's industrial ball valves are intended for general purpose use. Ball valves are intended for use in the fully open or closed positions. Throttling of the valve may result in premature seal failure and/or inability to turn the valve handle.

## Product Features:

- Forged brass body
- Chrome plated brass ball
- PTFE seats/seals
- Steel handle
- Standard Port
- Female/Female NPT Ports

## Specifications:

### Pressure Range:

- 600 WOG Cold Non-shock 1/2" – 2"
- Vacuum Service to 29 Inches Hg

### Temperature Range

- -40° to +350° F (-40° to +176.6° C)

G

H

I

J

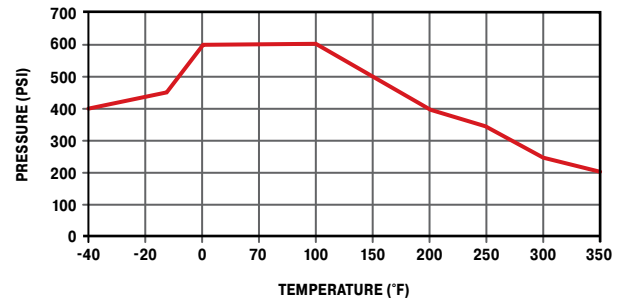

## Flow Coefficient

VALUE SIZE	1/2"	3/4"	1"	1-1/4"	1-1/2"	2"
CV	8.4	16	22	38	52	78

K

## Female Pipe Ends, V525P

PART NO.	D	DN	I	L	G	A	H	CH
V525P-8	1/2"	.453	.610	2.126	1.043	3.89	1.62	.984
V525P-12	3/4"	.590	.669	2.441	1.220	3.89	1.69	1.220
V525P-16	1"	.748	.827	2.835	1.417	4.72	1.98	1.496
V525P-20	1 1/4"	.945	.905	3.464	1.732	4.72	2.15	1.929
V525P-24	1 1/2"	1.181	.905	3.779	1.890	6.23	2.97	2.126
V525P-32	2"	1.496	1.043	4.409	2.205	6.23	3.24	2.677

Note: For larger sizes, please contact the division. Packing nut may need to be tightened depending on application temperature. Periodically check the packing nut and tighten as required

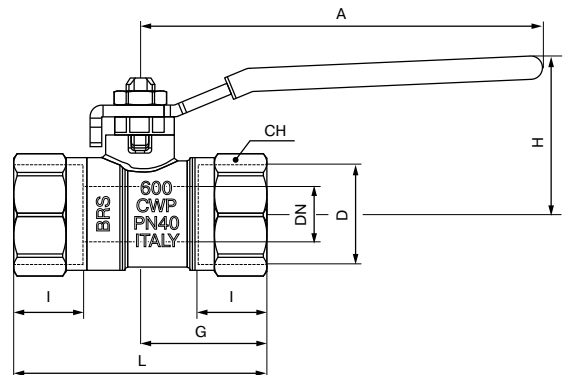

**WARNING** These products can expose you to chemicals including NICKEL or LEAD, which are known to the state of California to cause cancer, and LEAD which is known to cause birth defects or other reproductive harm. For more information go to [www.P65Warnings.ca.gov](http://www.P65Warnings.ca.gov).





# Ball Valves Brass Series 533 3-Way Diversion / Series 540 4-Way

## Product Features:

- Forged brass body
- Chrome plated brass ball
- PTFE seats/seals
- Steel handle

## Style:

- V-Valve
- VP-Valve, padlocking handle

## Type:

- 533 3-Way Diversion
- 540 4-Way

## Material:

- P-Brass

## Options:

- 02-Stainless Steel Handle & Nut
- 08-Unmarked yellow vinyl handle cover

## Specifications:

### Pressure Range:

- 400 PSI (27.5 bar)
- Vacuum Service to 29 Inches Hg

### Temperature Range

- -20° to +350° F (-6.6° to +176.6° C)

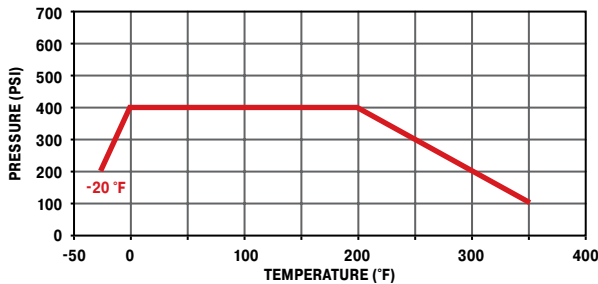

V540P FLOW INFORMATION	
POINTER OVER	FLOW PATH
A	A TO E
OFF	CLOSED
C	C TO E
D	D TO E

## V540P Handle Positions

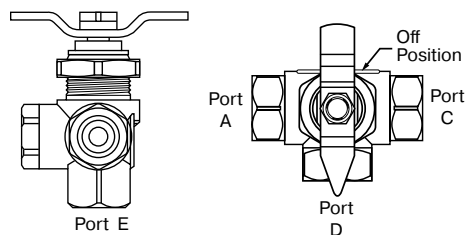

## V533P Handle Positions

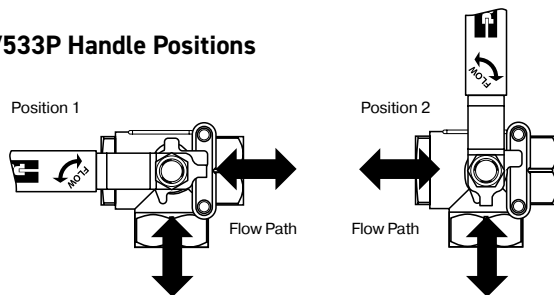

**WARNING** These products can expose you to chemicals including NICKEL or LEAD, which are known to the state of California to cause cancer, and LEAD which is known to cause birth defects or other reproductive harm. For more information go to [www.P65Warnings.ca.gov](http://www.P65Warnings.ca.gov).



[Click here for CADs, Product Specifications or to Configure Parts Online](#)

- A
- B
- C
- D
- E
- F
- G
- H
- I
- J
- K
- L
- M
- N
- O

### Female-Female-Female Pipe Ends V533P

PART NO.	PIPE THD (PTF)	B HEX	E	F	G	H	K	L	M	N	FLOW DIA. D
V533P-4	1/4	15/16	.50	1.08	1.12	3.96	1.03	2.47	2.03	1.94	.375
V533P-6	3/8	15/16	.50	1.08	1.12	3.96	1.03	2.47	2.03	1.94	.375
V533P-8	1/2	1-1/16	.50	1.18	1.12	3.96	1.11	2.58	2.20	1.98	.500
V533P-12	3/4	1-1/4	.87	1.43	1.37	3.96	1.42	2.90	2.83	2.17	.685
V533P-16	1	1-9/16	.87	1.62	1.37	3.96	1.58	3.21	3.16	2.32	.875

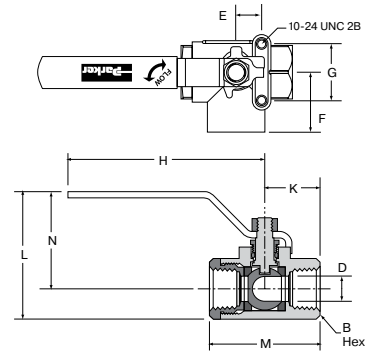

### Female-Female-Female-Female Pipe Ends V540P

PART NO.	PIPE THD (PTF)	B HEX	E	F	G	H	K	L	M	N	FLOW DIA. D
V540P-4	1/4	7/8	.32	1.00	1.76	1.25	1.98	2.49	.52	1.07	.250

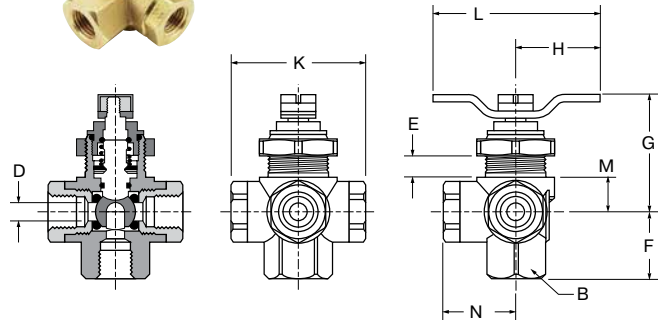

**WARNING** These products can expose you to chemicals including NICKEL or LEAD, which are known to the state of California to cause cancer, and LEAD which is known to cause birth defects or other reproductive harm. For more information go to [www.P65Warnings.ca.gov](http://www.P65Warnings.ca.gov).



# Ball Valves Brass Series 590/591



## Product Features:

- Forged brass body
- Chrome plated brass ball
- PTFE seats/seals
- Steel handle

## Style:

- V-Valve

## Type:

- 590-Male/Female
- 591-Male/Female

## Material:

- P-Brass

## Options:

- 04-Lever Handle
- 08-Unmarked yellow vinyl handle cover

## Specifications:

### Pressure Range:

- 250 PSI (17.2 bar)
- Saturated Steam up to 150 PSI (10.3 bar)
- Vacuum Service to 29 Inches Hg

### Temperature Range

- -50° to +350° F (-45.5° to +176.6° C)

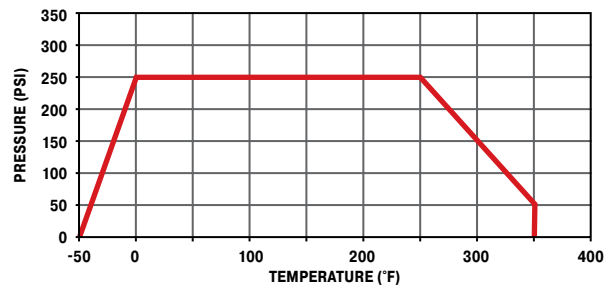

**WARNING** These products can expose you to chemicals including NICKEL or LEAD, which are known to the state of California to cause cancer, and LEAD which is known to cause birth defects or other reproductive harm. For more information go to [www.P65Warnings.ca.gov](http://www.P65Warnings.ca.gov).



A

B

C

D

E

F

G

H

I

J

K

L

M

N

O

Click here for CADs, Product Specifications or to Configure Parts Online

### 90° Flow, Male-Female Pipe Ends V590P

PART NO.	PIPE PTF THREAD	HEX	H	K	L	M	N	D FLOW Ø
V590P-4	1/4	15/16	1.25	1.08	2.50	1.00	2.42	.375
V590P-6	3/8	15/16	1.25	1.09	2.50	1.00	2.43	.375
V590P-8	1/2*	1-1/16	1.25	1.30	2.50	1.08	2.67	.500
V590P-16	1**	1-9/16"	1.30	1.90	2.60	1.38	3.62	.750

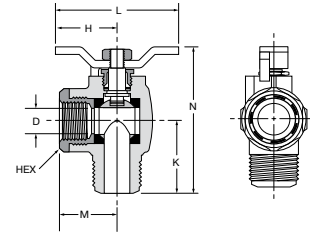

### Lever Handle, 90° Flow, Male-Female Pipe Ends V590P-X-04

PART NO.	PIPE PTF THREAD	HEX	H	K	L	M	N	D FLOW Ø
V590P-4-04	1/4	15/16	3.96	1.08	4.96	1.00	3.02	.375
V590P-6-04	3/8	15/16	3.96	1.09	4.96	1.00	3.03	.375
V590P-8-04	1/2*	1-1/16	3.80	1.30	4.88	1.08	2.95	.500
V590P-16-04	1**	1-9/16"	3.96	1.90	5.34	1.38	4.17	.750

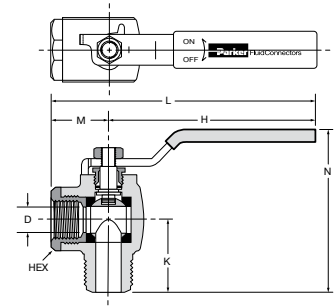

### 90° Flow, Male-Male Pipe Ends V591P

PART NO.	PIPE THREAD	HEX	H	K	L	M	N	D FLOW Ø
V591P-4	1/4	15/16	1.25	1.08	2.50	1.56	2.42	.375
V591P-6	3/8	15/16	1.25	1.09	2.50	1.56	2.43	.375
V591P-8	1/2	1-1/16	1.25	1.30	2.50	1.84	2.67	.500

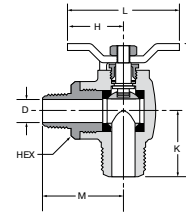

### Lever Handle, 90° Flow, Male-Male Pipe Ends V591P-X-04

PART NO.	PIPE THREAD	HEX	H	K	L	M	N	D FLOW Ø
V591P-4-04	1/4	15/16	3.96	1.08	5.52	1.56	3.02	.375
V591P-6-04	3/8	15/16	3.96	1.09	5.52	1.56	3.03	.375
V591P-8-04	1/2	1-1/16	3.80	1.30	5.64	1.84	2.95	.500

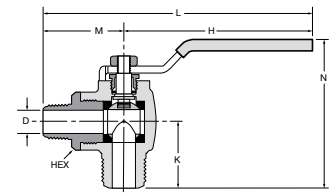

\*PTF Special Short. \*\*PTF SPL Extra Short

**WARNING** These products can expose you to chemicals including NICKEL or LEAD, which are known to the state of California to cause cancer, and LEAD which is known to cause birth defects or other reproductive harm. For more information go to [www.P65Warnings.ca.gov](http://www.P65Warnings.ca.gov).





# Ball Valves Brass Series 500HB



## Product Features:

- Forged brass body
- Chrome plated brass ball
- PTFE seats/seals
- Steel handle

## Style:

- V-Valve

## Type:

- 500HB-Female/Beaded Hose Barb

## Material:

- P-Brass

## Specifications:

### Pressure Range:

- 150 PSI (10.3 bar) WOG, Cold Non-Shock
- Saturated Steam up to 150 PSI (10.3 bar)
- Vacuum Service to 29 Inches Hg

### Temperature Range

- 0° to +350° F (-17.7° to +176.6° C)

## Brass Hose Barb Ball Valve V500P-HB

PART NO.	PORT 1	PORT 2 PTF	B HEX	C HEX	H	L	M	N	FLOW DIA. D
V500P-12-16HB	1	3/4*	1-1/4	1-5/16	3.96	6.25	3.41	2.81	.685

\*PTF special extra short

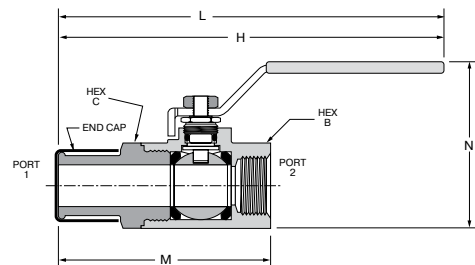

**WARNING** These products can expose you to chemicals including NICKEL or LEAD, which are known to the state of California to cause cancer, and LEAD which is known to cause birth defects or other reproductive harm. For more information go to [www.P65Warnings.ca.gov](http://www.P65Warnings.ca.gov).



# Ball Valves Brass Series 600



### Product Features:

- Forged brass body
- Chrome plated brass ball
- PTFE seats/seals
- Fluorocarbon O-rings
- Steel handle

### Style:

- V-Valve

### Type:

- 600-Three Position
- 633-Two Position

### Material:

- P-Brass

### Specifications:

#### Pressure Range:

- 150 PSI (10.3 bar)
- Vacuum Service to 29 Inches Hg

#### Temperature Range

- 0° to +250° F (-17.7° to +121.1° C)

### Series 600 Handle Positions

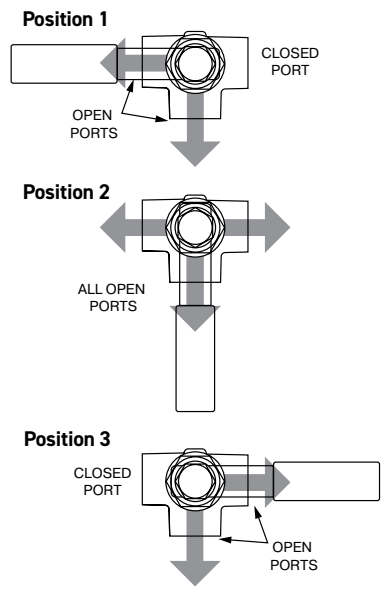

### Series 633 Handle Positions

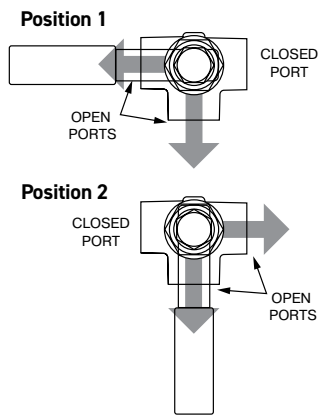

This valve can be used on applications where a fluid return or spillback is required. For use on construction equipment, chemical processing, diesel engines, filter banks, pumps and specialized industrial machinery.

NOTE: Diversion valves do not have off positions, therefore, the center ports can not be used for shut-off purposes.

**WARNING** These products can expose you to chemicals including NICKEL or LEAD, which are known to the state of California to cause cancer, and LEAD which is known to cause birth defects or other reproductive harm. For more information go to [www.P65Warnings.ca.gov](http://www.P65Warnings.ca.gov).

[Click here for CADs, Product Specifications or to Configure Parts Online](#)

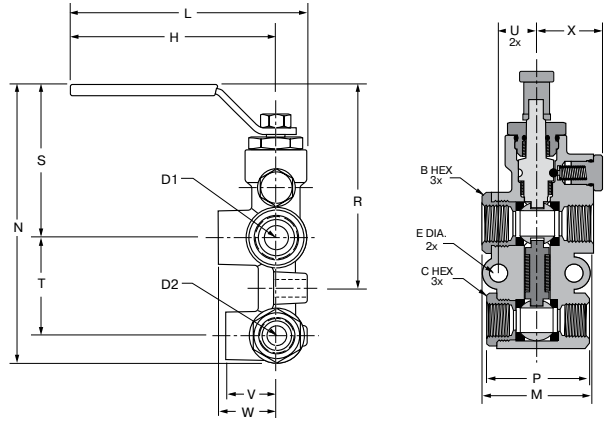

**Six Port Diversion Brass Valve V600P**

PIPE THD. PART NO.	PIPE THD. TOP PORT SPL SHORT	BOTTOM PORT PTF	B HEX	C HEX	D1 FLOW	D2 FLOW	E	H	L	M	N	P	R	S	T	U	V	W	X
V600P-8-6	1/2	3/8	1 1/16	15/16	.500	.375	.34	3.96	4.56	2.20	5.43	2.03	3.98	2.99	1.91	.73	.98	1.12	1.31

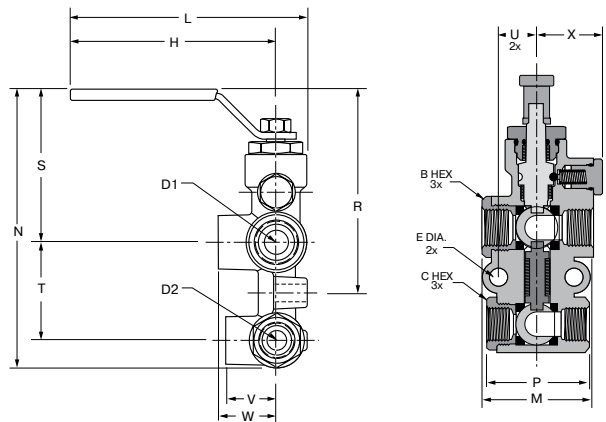

**Six Port Diversion Brass Valve V633P**

PIPE THD. PART NO.	PIPE THD. TOP PORT SPL SHORT	BOTTOM PORT PTF	B HEX	C HEX	D1 FLOW	D2 FLOW	E	H	L	M	N	P	R	S	T	U	V	W	X
V633P-8-6	1/2	3/8	1 1/16	15/16	.500	.375	.34	3.96	4.56	2.20	5.43	2.03	3.98	2.99	1.91	.73	.98	1.12	1.31

**WARNING** These products can expose you to chemicals including NICKEL or LEAD, which are known to the state of California to cause cancer, and LEAD which is known to cause birth defects or other reproductive harm. For more information go to [www.P65Warnings.ca.gov](http://www.P65Warnings.ca.gov).



- A
- B
- C
- D
- E
- F
- G
- H
- I
- J
- K
- L
- M
- N
- O

A  
B  
C  
D  
E  
F  
G  
H  
I  
J  
K  
L  
M  
N  
O



# Ball Valves

## Carbon Steel Series 500CS/502CS

### Product Features:

- Carbon Steel Phosphate Coated body
- Steel ball
- PTFE seats/seals
- Steel handle

### Style:

- V-Valve
- VP-Valve, padlocking handle

### Type:

- 500-Female/Female
- 502-Female/Female

### Material:

- CS-Carbon Steel

### Options:

- 04-Tee Handle
- 21-Oval Handle

### Specifications:

#### Pressure Range:

- 1/4" – 1": 2000 PSI (137.8 bar)
- 1 1/4" – 2": 1500 PSI (103.4 bar)
- Saturated Steam up to 150 PSI (10.3 bar)

#### Temperature Range

- 20° to +425° F (-28.8° to +218.3° C)

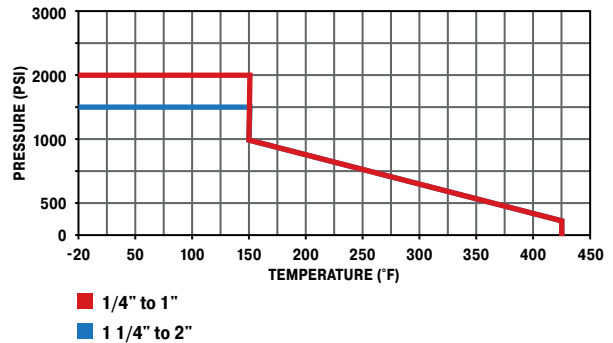

FLOW DATA	
VALVE SIZE	CV
1/4	6.0
3/8	12.8
1/2	15.0
3/4	23.0
1	36.0
1-1/4	44.0
1-1/2	64.0
2	114.0

**WARNING** These products can expose you to chemicals including NICKEL, which is known to the state of California to cause cancer. For more information go to [www.P65Warnings.ca.gov](http://www.P65Warnings.ca.gov).



Click here for CADs, Product Specifications or to Configure Parts Online

### Female-Female Pipe Ends V500CS

PART NO.	PIPE THREAD	B HEX	C HEX	H	L	M	N	D FLOW Ø
V500CS-4	1/4	1-1/16	15/16	3.78	1.00	2.00	1.63	.400
V500CS-6	3/8	1-1/16	15/16	3.78	1.00	2.00	1.63	.400
V500CS-8	1/2	1-1/4	1-1/16	3.78	1.25	2.37	1.73	.540
V500CS-12	3/4	1-5/8	1-3/8	5.10	1.50	2.90	2.08	.680
V500CS-16	1	2	1-5/8	5.10	1.76	3.41	2.30	.880

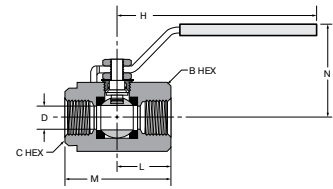

### Female-Female Pipe Ends, Panel Mount V502CS

PART NO.	PIPE THD	B HEX	C HEX	F	G	H	L	M	N	FLOW DIA. D
V502CS-20	1-1/4	2	2-1/4	.94	1.50	6.10	1.87	3.80	2.76	1.000
V502CS-24	1-1/2	2-5/16	2-1/2	.94	1.50	6.10	2.27	4.55	2.98	1.250
V502CS-32	2	2-3/4	3	1.03	2.00	8.60	2.42	4.83	3.54	1.500

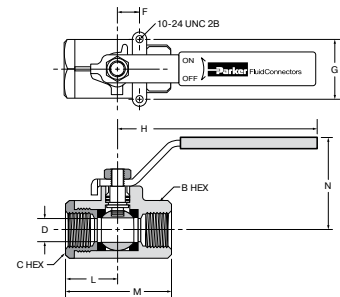

### Locking Handle, Female Pipe Ends VP500CS

PART NO.	PIPE THD	B HEX	C HEX	H	L	M	N	D FLOW Ø
VP500CS-4	1/4	1-1/16	15/16	4.13	1.00	2.00	2.23	.400
VP500CS-6	3/8	1-1/16	15/16	4.13	1.00	2.00	2.23	.400
VP500CS-8	1/2	1-1/4	1-1/16	4.13	1.25	2.37	2.33	.540
VP500CS-12	3/4	1-5/8	1-3/8	5.00	1.50	2.90	2.80	.680
VP500CS-16	1	2	1-5/8	5.00	1.76	3.41	2.97	.880

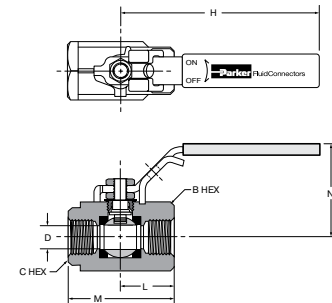

### Locking Handle, Female Pipe Ends, Panel Mount VP502CS

PART NO.	PIPE THD	B HEX	C HEX	F	G	H	L	M	N	FLOW DIA. D
VP502CS-20	1-1/4	2	2-1/4	.94	1.50	7.50	1.87	3.80	3.15	1.000
VP502CS-24	1-1/2	2-5/16	2-1/2	.94	1.50	7.50	2.27	4.55	3.37	1.250
VP502CS-32	2	2-3/4	3	1.03	2.00	8.75	2.42	4.83	3.46	1.500

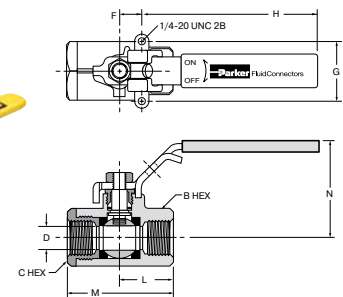

### Tee Handle, Female Pipe Ends V500CS-X-04

PART NO.	PIPE THD	B HEX	C HEX	H	L	M	N	D FLOW Ø
V500CS-4-04	1/4	1-1/16	15/16	2.16	1.08	2.00	1.41	.400
V500CS-6-04	3/8	1-1/16	15/16	2.16	1.08	2.00	1.41	.400
V500CS-8-04	1/2	1-1/4	1-1/16	2.90	1.45	2.37	1.66	.540
V500CS-12-04	3/4	1-5/8	1-3/8	3.63	1.81	2.90	2.06	.680
V500CS-16-04	1	2	1-5/8	3.63	1.81	3.41	2.23	.880

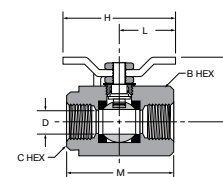

**WARNING** These products can expose you to chemicals including NICKEL, which is known to the state of California to cause cancer. For more information go to [www.P65Warnings.ca.gov](http://www.P65Warnings.ca.gov).

- A
- B
- C
- D
- E
- F
- G
- H
- I
- J
- K
- L
- M
- N
- O

Click here for CADs, Product Specifications or to Configure Parts Online

**Oval Handle, Female Pipe Ends V500CS-X-21**

PART NO.	PIPE THD	B HEX	C HEX	H	L	M	N	D FLOW Ø
V500CS-4-21	1/4	1-1/16	15/16	3.50	1.00	2.00	1.66	.400
V500CS-6-21	3/8	1-1/16	15/16	3.50	1.00	2.00	1.66	.400
V500CS-8-21	1/2	1-1/4	1-1/16	3.50	1.13	2.37	1.76	.540
V500CS-12-21	3/4	1-5/8	1-3/8	5.00	1.46	2.90	2.13	.680
V500CS-16-21	1	2	1-5/8	5.00	1.58	3.41	2.29	.880

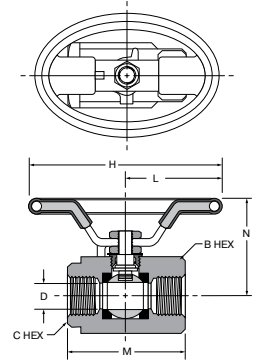

**Oval Handle, Female Pipe Ends, Panel Mount V502CS-X-21**

PART NO.	PIPE THD	B HEX	C HEX	F	G	H	L	M	N	FLOW DIA. D
V502CS-20-21	1-1/4	2	2-1/4	.94	1.50	5.07	2.53	3.80	3.04	1.000
V502CS-24-21	1-1/2	2-5/16	2-1/2	.94	1.50	5.07	2.53	4.55	3.26	1.250
V502CS-32-21	2	2-3/4	3	1.03	2.00	6.50	3.25	4.83	3.57	1.500

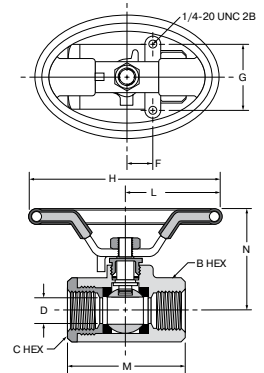

**WARNING** These products can expose you to chemicals including NICKEL, which is known to the state of California to cause cancer. For more information go to [www.P65Warnings.ca.gov](http://www.P65Warnings.ca.gov).





# Ball Valves

## Carbon Steel Series 506CS

### Product Features:

- Carbon Steel Phosphate Coated body
- Steel ball
- PTFE seats/seals
- Steel handle

### Style:

- V-Valve
- VP-Valve, padlocking handle

### Type:

- 506-Female/Female SAE Straight Thread Ports

### Material:

- CS-Carbon Steel

### Options:

- 04-Tee Handle
- 21-Oval Handle

### Specifications:

#### Pressure Range:

- 3000 PSI (206.8 bar)
- Saturated Steam up to 150 PSI (10.3 bar)

#### Temperature Range

- -20° to +425° F (-28.8° to +218.3° C)

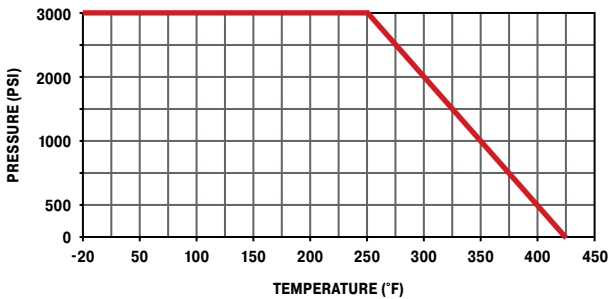

FLOW DATA	
VALVE SIZE	CV
1/4	6.0
3/8	12.0
1/2	15.0
3/4	34.0
1	54.0

### Female-Female SAE Straight Thread Ports V506CS

PART NO.	STRAIGHT THREAD	B HEX	C HEX	H	L	M	N	D FLOW Ø
V506CS-4	7/16-20	1-1/16	15/16	3.78	1.00	2.00	1.63	.400
V506CS-6	9/16-18	1-1/16	15/16	3.78	1.00	2.00	1.63	.400
V506CS-8	3/4-16	1-5/8	1-1/4	4.78	1.32	2.84	2.16	.500
V506CS-12	1-1/16-12	1-7/8	1-5/8	4.78	1.66	3.71	2.35	.750
V506CS-16	1-5/16-12	2-1/2	2-1/8	6.10	1.88	4.15	2.85	1.000

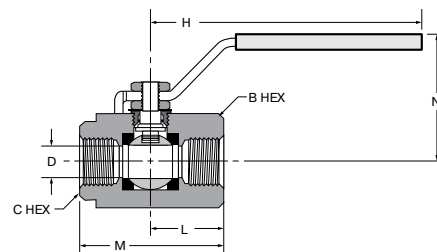

**WARNING** These products can expose you to chemicals including NICKEL, which is known to the state of California to cause cancer. For more information go to [www.P65Warnings.ca.gov](http://www.P65Warnings.ca.gov).



A

B

C

D

E

F

G

H

I

J

K

L

M

N

O

A  
B  
C  
D  
E  
F  
G  
H  
I  
J  
K  
L  
M  
N  
O



# Ball Valves

## Carbon Steel Series 500HP, 506HP

### Product Features:

- Carbon Steel Phosphate Coated body
- Steel ball
- Delrin with Molybdenum Disulphide Seats
- Nitrile O-rings Stem Seals
- Steel handle

### Style:

- V-Valve
- VP-Valve, padlocking handle

### Type:

- 500-Female/Female NPT Ports
- 506-Female/Female SAE Straight Thread Ports

### Material:

- HP-High Pressure Carbon Steel

### Specifications:

#### Pressure Range:

- 6000 PSI (413.6 bar)

#### Temperature Range

- -10° to +210° F (-23.3° to 98.8° C)

Pressure Drop (PSI)

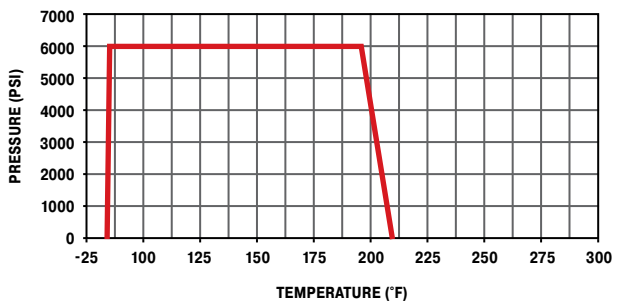
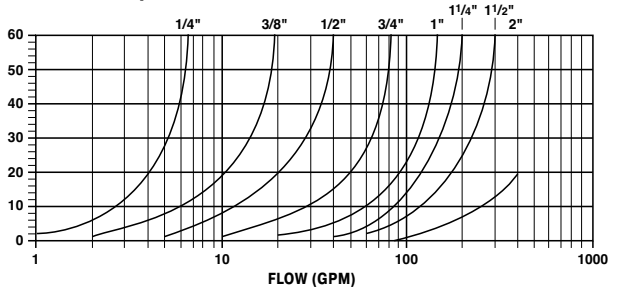

**WARNING** These products can expose you to chemicals including NICKEL, which is known to the state of California to cause cancer. For more information go to [www.P65Warnings.ca.gov](http://www.P65Warnings.ca.gov).



### 6000 PSI Female-Female Pipe Ends V500HP-X

PART NO.	PIPE THREAD [NPT]	B	C	H	L	M	N	FLOW DIA. D
V500HP-4	1/4-18	.69	1.38	4.50	1.44	2.75	2.94	.240
V500HP-6	3/8-18	.56	1.50	4.50	1.69	2.88	3.06	.390
V500HP-8	1/2-14	.75	1.63	4.50	1.88	3.38	3.19	.510
V500HP-12	3/4-14	.69	2.25	7.00	2.41	3.81	4.69	.790
V500HP-16	1-11.5	.94	2.50	7.00	2.56	4.50	4.94	.950

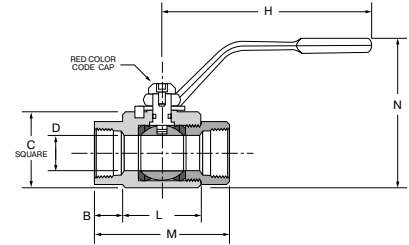

### 6000 PSI Female-Female Pipe Ends V500HP-X (LARGE)

PART NO.	PIPE THREAD [NPT]	B	C	H	L	M	N	FLOW DIA. D
V500HP-20	1 1/4-11.5	.85	3.25	10.00	3.15	4.84	6.31	1.26
V500HP-24	1 1/2-11.5	.99	3.75	10.00	3.35	5.33	6.76	1.50
V500HP-32	2-11.5	1.30	4.50	10.00	3.94	6.54	7.42	1.89

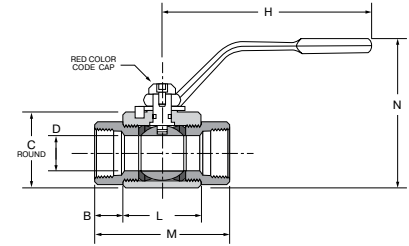

### 6000 PSI Locking-Female-Female Pipe Ends VP500HP-X

PART NO.	PIPE THREAD [NPT]	B	C	H	L	M	N	FLOW DIA. D
VP500HP-4	1/4-18	.69	1.38	4.50	1.44	2.75	2.94	.240
VP500HP-6	3/8-18	.56	1.50	4.50	1.69	2.88	3.06	.390
VP500HP-8	1/2-14	.75	1.63	4.50	1.88	3.38	3.19	.510
VP500HP-12	3/4-14	.69	2.25	7.00	2.41	3.81	4.69	.790
VP500HP-16	1-11.5	.94	2.50	7.00	2.56	4.50	4.94	.950

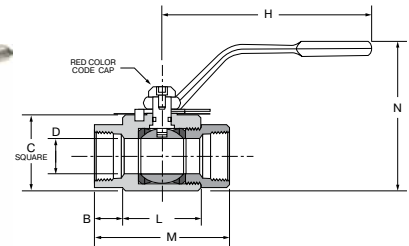

### 6000 PSI Locking-Female-Female Pipe Ends VP500HP-X (LARGE)

PART NO.	PIPE THREAD [NPT]	B	C	H	L	M	N	FLOW DIA. D
VP500HP-20	1 1/4-11.5	.85	3.25	10.00	3.15	4.84	6.31	1.26
VP500HP-24	1 1/2-11.5	.99	3.75	10.00	3.35	5.33	6.76	1.50
VP500HP-32	2-11.5	1.30	4.50	10.00	3.94	6.54	7.42	1.89

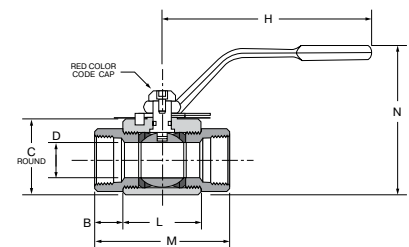

**WARNING** These products can expose you to chemicals including NICKEL, which is known to the state of California to cause cancer. For more information go to [www.P65Warnings.ca.gov](http://www.P65Warnings.ca.gov).



- A
- B
- C
- D
- E
- F
- G
- H
- I
- J
- K
- L
- M
- N
- O

### 6000 PSI Female-Female Straight Thread Ends V506HP-X

PART NO.	SAE J1926-1 THREAD	B	C	H	L	M	N	FLOW DIA. D
V506HP-4	7/16-20 UNF	.69	1.38	4.50	1.44	2.75	2.94	.240
V506HP-6	9/16-18 UNF	.56	1.50	4.50	1.69	2.88	3.06	.390
V506HP-8	3/4-16 UNF	.75	1.63	4.50	1.88	3.38	3.19	.510
V506HP-12	1 1/16-12 UNF	.69	2.25	7.00	2.41	3.81	4.69	.790
V506HP-16	1 5/16-12 UNF	.94	2.50	7.00	2.56	4.50	4.94	.950

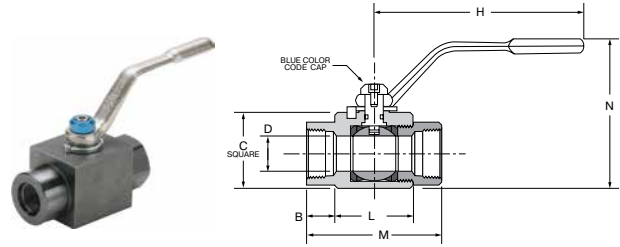

### 6000 PSI Female-Female Straight Thread Ends V506HP-X (LARGE)

PART NO.	SAE J1926-1 THREAD	B	C	H	L	M	N	FLOW DIA. D
V506HP-20	1 5/8-12 UNF	.85	3.25	10.00	3.15	4.84	6.31	1.26
V506HP-24	1 7/8-12 UNF	.99	3.75	10.00	3.35	5.33	6.76	1.50
V506HP-32	2 1/2-12 UNF	1.30	4.50	10.00	3.94	6.54	7.42	1.89

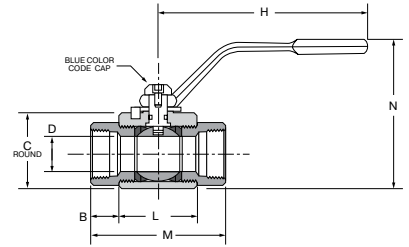

### 6000 PSI Locking-Female-Female Straight Thread Ends VP506HP-X

PART NO.	SAE J1926-1 THREAD	B	C	H	L	M	N	FLOW DIA. D
VP506HP-4	7/16-20 UNF	.69	1.38	4.50	1.44	2.75	2.94	.240
VP506HP-6	9/16-18 UNF	.56	1.50	4.50	1.69	2.88	3.06	.390
VP506HP-8	3/4-16 UNF	.75	1.63	4.50	1.88	3.38	3.19	.510
VP506HP-12	1 1/16-12 UNF	.69	2.25	7.00	2.41	3.81	4.69	.790
VP506HP-16	1 5/16-12 UNF	.94	2.50	7.00	2.56	4.50	4.94	.950

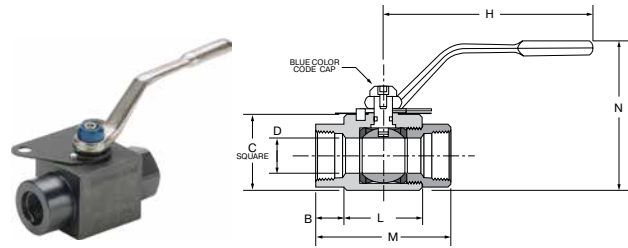

### 6000 PSI Locking-Female-Female Straight Thread Ends VP506HP-X (LARGE)

PART NO.	SAE J1926-1 THREAD	B	C	H	L	M	N	FLOW DIA. D
VP506HP-20	1 5/8-12 UNF	.85	3.25	10.00	3.15	4.84	6.31	1.26
VP506HP-24	1 7/8-12 UNF	.99	3.75	10.00	3.35	5.33	6.76	1.50
VP506HP-32	2 1/2-12 UNF	1.30	4.50	10.00	3.94	6.54	7.42	1.89

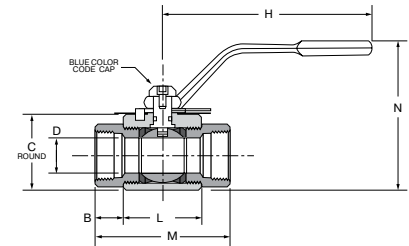

**WARNING** These products can expose you to chemicals including NICKEL, which is known to the state of California to cause cancer. For more information go to [www.P65Warnings.ca.gov](http://www.P65Warnings.ca.gov).



# Ball Valves

## Stainless Steel Series 501SS

### Product Features:

- CF-8M Stainless Steel body
- Stainless Steel ball
- PTFE Seats/Seals
- Stainless Steel handle
- Silicone Free

### Material:

- SS – Stainless Steel

### Options

- 20-Short Handle
- 21-Oval Handle
- 35-Welded Retainer Nut

### Specifications:

#### Pressure Range:

- 2000 PSI (137.8 bar)
- Vacuum service 28 inches Hg

#### Temperature Range

- 0° to +400° F (-17.7° to +204.4° C)

### Approvals

- Meets material requirements of NACE MR-01-75

### Style:

- V-Valve

### Type:

- 501-Male/Female NPT Ports

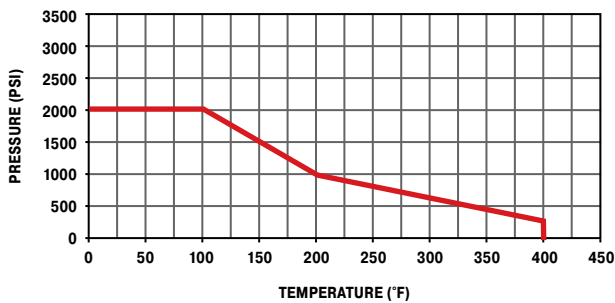

FLOW DATA	
VALVE SIZE	CV
1/4	4.0
3/8	6.0
1/2	14.0
3/4	35.0
1	54.0

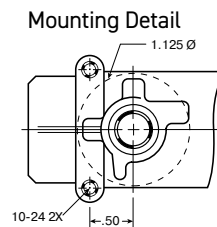

### Male-Female Pipe Ends V501SS

PART NO.	PIPE THREAD [NPT]	HEX	F	G	L	M	N	D FLOW Ø
V501SS-4	1/4	15/16	.50	1.12	5.60	2.65	1.97	.280
V501SS-6	3/8	15/16	.50	1.12	5.60	2.65	1.97	.375
V501SS-8	1/2	1-1/16	.50	1.12	5.85	3.05	2.00	.500
V501SS-12	3/4	1-3/8	.88	1.37	7.27	3.85	2.55	.720
V501SS-16	1	1-5/8	.88	1.37	7.48	4.25	2.68	.940

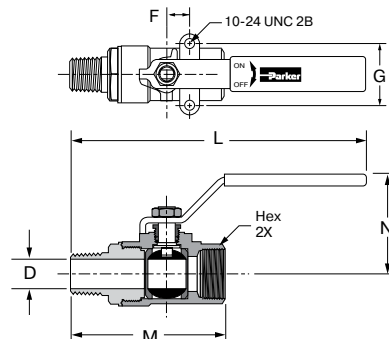

**WARNING** These products can expose you to chemicals including NICKEL, which is known to the state of California to cause cancer. For more information go to [www.P65Warnings.ca.gov](http://www.P65Warnings.ca.gov).



A

B

C

D

E

F

G

H

I

J

K

L

M

N

O

A  
B  
C  
D  
E  
F  
G  
H  
I  
J  
K  
L  
M  
N  
O



# Ball Valves

## Stainless Steel Series 502SS

### Product Features:

- CF-8M Stainless Steel body
- Stainless Steel ball
- PTFE Seats/Seals
- Stainless Steel handle
- Silicone Free

### Style:

- V-Valve
- VP-Valve, Padlocking

### Type:

- 502-Panel Mount Female/  
Female NPT Ports

### Material:

- SS – Stainless Steel

### Options

- 20-Short Handle
- 21-Oval Handle
- 35-Welded Retainer Nut

### Specifications:

#### Pressure Range:

- 1/4" – 1": 2000 PSI (137.8 bar)
- 1 1/4" – 2": 1500 PSI (103.4 bar)
- Vacuum service 28 inches Hg

#### Temperature Range

- 0° to +400° F (-17.7° to +204.4° C)

### Approvals

- Meets material requirements of NACE MR-01-75

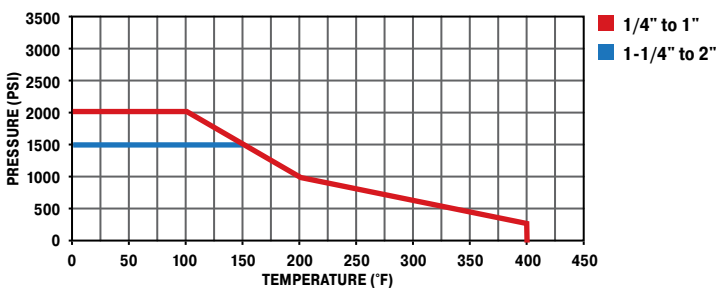

FLOW DATA	
VALVE SIZE	CV
1/4	4.0
3/8	6.0
1/2	14.0
3/4	35.0
1	54.0
1 1/4	74.0
1 1/2	120.0
2	226.0

MOUNTING HOLE DIAMETER	
VALVE SIZE	DIA. IN.
1/4	1.125
3/8	1.125
1/2	1.125
3/4	1.500
1	1.500
1 1/4	1.875
1 1/2	1.875
2	1.875

### Mounting Detail

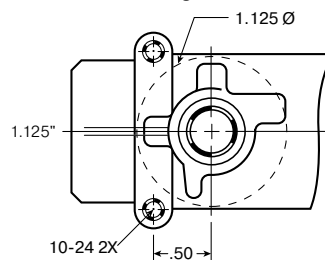

Note: Periodically check the adjustable packing nut and tighten as required.

**WARNING** These products can expose you to chemicals including NICKEL, which is known to the state of California to cause cancer. For more information go to [www.P65Warnings.ca.gov](http://www.P65Warnings.ca.gov).



Click here for CADs, Product Specifications or to Configure Parts Online

### Female Pipe Ends, Panel Mount V502SS

PART NO.	PIPE THD (NPT)	B/C HEX	F	G	H	I THREAD	L	M	N	PANEL FLOW DIA. D	HOLE DIA.
V502SS-4	1/4	15/16	.500	1.125	4.00	10-24 UNC	5.03	2.07	2.52	.380	1.125
V502SS-6	3/8	15/16	.500	1.125	4.00	10-24 UNC	5.03	2.07	2.52	.380	1.125
V502SS-8	1/2	1-1/16	.500	1.125	4.00	10-24 UNC	5.13	2.27	2.65	.500	1.125
V502SS-12	3/4	1-3/8	.875	1.375	5.00	10-24 UNC	6.67	3.35	3.46	.790	1.500
V502SS-16	1	1-5/8	.875	1.375	5.00	10-24 UNC	6.77	3.54	3.74	1.000	1.500
V502SS-20	1-1/4	2	1.000	1.500	7.00	1/4-20 UNC	9.00	4.00	4.55	1.250	2.000
V502SS-24	1-1/2	2-3/8	1.000	1.500	7.00	1/4-20 UNC	7.19	4.38	5.42	1.500	2.000
V502SS-32	2	3	1.000	1.500	7.00	1/4-20 UNC	9.75	5.50	5.68	2.000	2.000

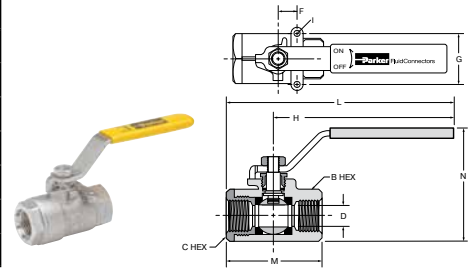

### Short Handle, Female Pipe Ends, Panel Mount V502SS-X-20

PART NO.	PIPE THD [NPT]	B/C HEX	G	H	L	M	N	FLOW DIA. D
V502SS-4-20	1/4	15/16	1.12	2.28	3.32	2.07	2.53	.375
V502SS-6-20	3/8	15/16	1.12	2.28	3.32	2.07	2.53	.375
V502SS-8-20	1/2	1-1/16	1.12	2.22	3.37	2.25	2.63	.500

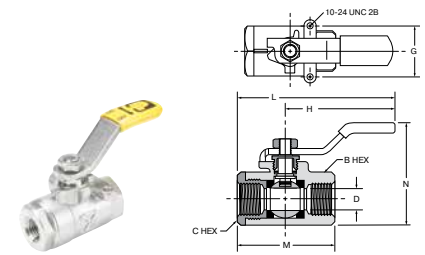

### Locking Handle, Female Pipe Ends, Panel Mount VP502SS

PART NO.	PIPE THD (NPT)	B/C HEX	F	G	H	I THREAD	L	M	N	PANEL FLOW DIA. D	HOLE DIA.
VP502SS-4	1/4	15/16	.500	1.125	4.00	10-24 UNC	5.03	2.07	2.52	.380	1.125
VP502SS-6	3/8	15/16	.500	1.125	4.00	10-24 UNC	5.03	2.07	2.52	.380	1.125
VP502SS-8	1/2	1-1/16	.500	1.125	4.00	10-24 UNC	5.13	2.27	2.65	.500	1.125
VP502SS-12	3/4	1-3/8	.875	1.375	5.00	10-24 UNC	6.67	3.35	3.46	.790	1.500
VP502SS-16	1	1-5/8	.875	1.375	5.00	10-24 UNC	6.77	3.54	3.74	1.000	1.500
VP502SS-20	1-1/4	2	1.000	1.500	7.00	1/4-20 UNC	9.00	4.00	4.55	1.250	2.000
VP502SS-24	1-1/2	2-3/8	1.000	1.500	7.00	1/4-20 UNC	7.19	4.38	5.42	1.500	2.000
VP502SS-32	2	3	1.000	1.500	7.00	1/4-20 UNC	9.75	5.50	5.68	2.000	2.000

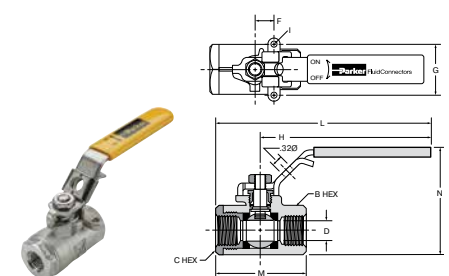

### Oval Handle, Female Pipe Ends, Panel Mount V502SS-X-21

PART NO.	PIPE THD (NPT)	B/C HEX	G	H	L	I THREAD	M	N	PANEL FLOW DIA. D	HOLE DIA.
V502SS-4-21	1/4	15/16	1.125	1.74	3.48	10-24 UNC	2.07	2.43	.380	1.125
V502SS-6-21	3/8	15/16	1.125	1.74	3.48	10-24 UNC	2.07	2.43	.380	1.125
V502SS-8-21	1/2	1-1/16	1.125	1.74	3.48	10-24 UNC	2.27	2.54	.500	1.125
V502SS-12-21	3/4	1-3/8	1.375	2.68	5.36	10-24 UNC	3.35	3.45	.790	1.500
V502SS-16-21	1	1-5/8	1.375	2.68	5.36	10-24 UNC	3.54	3.74	1.000	1.500

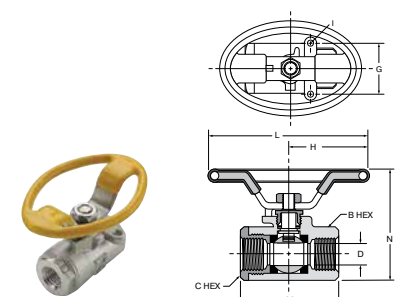

**WARNING** These products can expose you to chemicals including NICKEL, which is known to the state of California to cause cancer. For more information go to [www.P65Warnings.ca.gov](http://www.P65Warnings.ca.gov).

- A
- B
- C
- D
- E
- F
- G
- H
- I
- J
- K
- L
- M
- N
- O

# Ball Valves

## Micro Series 708/709



### Product Features:

- Brass Body
- Chrome Plated Brass Ball
- PTFE Seats/Seals
- Nitrile Stem Seal
- Chrome Plated Steel Handle

### Style:

- MV-Micro Valve

### Type:

- 708-Male/Female
- 709-Female/Female

### Specifications:

#### Pressure Range:

- Up to 500 PSI (34.4 bar)
- Vacuum service 29 inches Hg

#### Temperature Range

- -35° to +300° F (-37.2 to +148.8° C)



FLOW DATA		
VALVE SIZE	MV708 CV	MV709 CV
1/4	.95	.95

### Male-Female Pipe Ends, Mini Ball Valve MV708

PART NO.	PIPE THREAD	B HEX	H	L	M	N	P	FLOW DIA. D
MV708-2	1/8	9/16	1.18	.63	1.62	.93	.38	.180
MV708-4	1/4	11/16	1.52	.70	1.57	.79	.50	.210

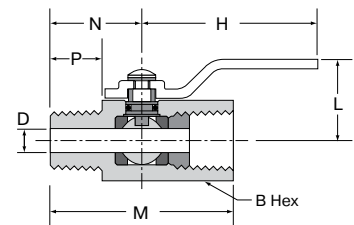

### Female Pipe Ends, Mini Ball Valve MV709

PART NO.	PIPE THREAD	B HEX	H	L	M	N	FLOW DIA. D
MV709-2	1/8	9/16	1.18	.63	1.52	.68	.180
MV709-4	1/4	11/16	1.52	.70	1.57	.76	.210

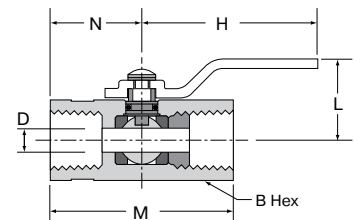

**WARNING** These products can expose you to chemicals including NICKEL or LEAD, which are known to the state of California to cause cancer, and LEAD which is known to cause birth defects or other reproductive harm. For more information go to [www.P65Warnings.ca.gov](http://www.P65Warnings.ca.gov).





# Ball Valves

## Mini Series 200/608/609

### Product Features:

- Chrome Plated Brass Body
- Chrome Plated Brass Ball
- PTFE Seats/Seals
- Fluorocarbon Stem Seal
- 608/609 Polyamide Wedge Handle
- 200 Polyamide Lever Handle

### Style:

- MV-Mini Valve

### Type:

- 608-Male/Female
- 609-Female/Female
- 200-Female/Female
- 21-Oval Handle

### Specifications:

#### Pressure Range:

- MV200: 200 PSI (13.7 bar)
- MV608/609: Vacuum Service 28 Inches Hg
- MV608/609: 450 PSI (31.0 bar)

#### Temperature Range

- 0° to +200° F (-17.7° to +93.3° C)

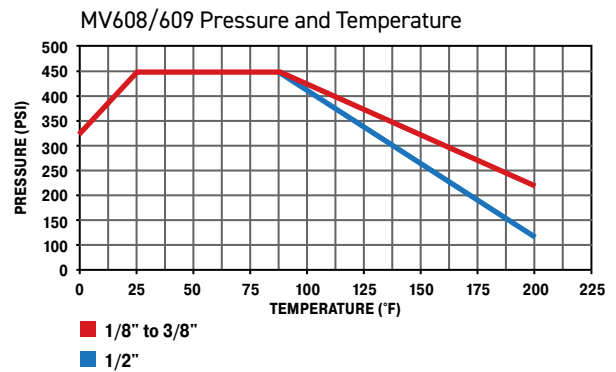
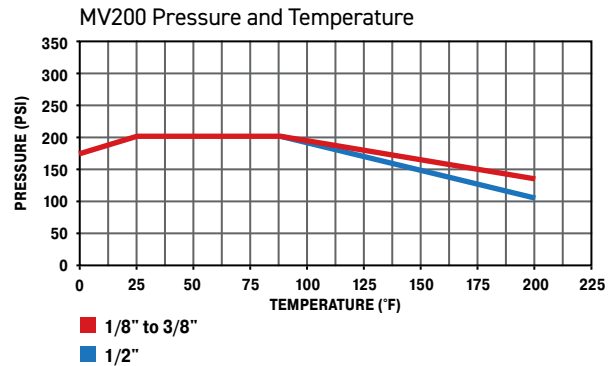

FLOW DATA			
VALVE SIZE	MV200 CV	MV608 CV	MV609 CV
1/8	1.3	1.2	1.4
1/4	4.0	5.8	4.3
3/8	3.7	3.9	3.6
1/2	5.8	5.6	6.0

**WARNING** These products can expose you to chemicals including NICKEL or LEAD, which are known to the state of California to cause cancer, and LEAD which is known to cause birth defects or other reproductive harm. For more information go to [www.P65Warnings.ca.gov](http://www.P65Warnings.ca.gov).



Click here for CADs, Product Specifications or to Configure Parts Online

- A
- B
- C
- D
- E
- F
- G
- H
- I
- J
- K
- L
- M
- N
- O

### Female Pipe Ends, Lever Handle, Mini Ball Valve MV200

PART NO.	PIPE THREAD	HEX	B	C	H	L	FLOW DIA. D
MV200-2	1/8	.83	1.71	1.20	.91	2.83	.31
MV200-4	1/4	.83	1.71	1.20	.91	2.83	.31
MV200-6	3/8	.83	1.71	1.20	.91	2.83	.31
MV200-8	1/2	.98	2.11	1.28	1.10	2.83	.39

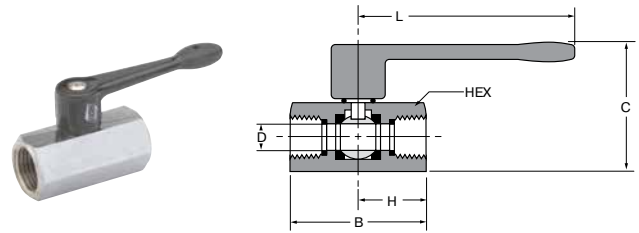

### Male-Female Pipe Ends, Compact Handle, Mini Ball Valve MV608

PART NO.	PIPE THREAD	A HEX	B	C	FLOW DIA. D
MV608-2	1/8	.83	1.72	1.22	.20
MV608-4	1/4	.83	1.72	1.22	.31
MV608-6	3/8	.83	1.72	1.22	.31
MV608-8	1/2	.98	2.11	1.30	.39

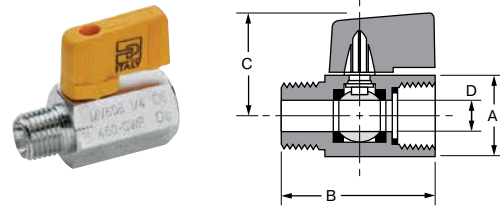

### Female Pipe Ends, Compact Handle, Mini Ball Valve MV609

PART NO.	PIPE THREAD	A HEX	B	C	FLOW DIA. D
MV609-2	1/8	.83	1.71	1.22	.24
MV609-4	1/4	.83	1.71	1.22	.31
MV609-6	3/8	.83	1.71	1.22	.31
MV609-8	1/2	.98	2.11	1.30	.39
MV609-6-4	3/8X1/4	.83	1.71	1.22	.31

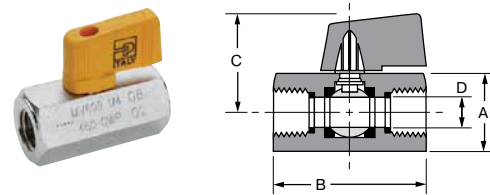

**WARNING** These products can expose you to chemicals including NICKEL or LEAD, which are known to the state of California to cause cancer, and LEAD which is known to cause birth defects or other reproductive harm. For more information go to [www.P65Warnings.ca.gov](http://www.P65Warnings.ca.gov).



# Ball Valves Polypropylene



Parker's Polypropylene Ball Valves offers a corrosion-resistant, all plastic design making them ideal for water filtration units, coffee and beverage machines and a wide variety of other fluid applications.

## Product Features:

- Wide chemical acceptance range
- Bi-directional flow maximizes productivity
- Full flow reduces pressure drop across valve
- EPDM Seals – LIQUIfit, TrueSeal, and Par-barb
- Nitrile Seals – Fast and Tite
- Push-in and barbed connections
- Meets FDA and NSF/ANSI 51 requirements for food contact
- LIQUIfit, Par-Barb, and TrueSeal meet NSF/ANSI 61 requirements

## Advantages:

- Reduce costs – Built in LIQUIfit, TrueSeal and Par-Barb connections eliminates the need for a secondary fitting.
- Save Space – Low-profile design allows for easy assembly and access where space is a concern.

## Type:

- LFPP – LIQUIfit
- PP – TrueSeal
- PBPP – Par-Barb
- FTTPB - Fast and Tite

## Specifications:

**Pressure Range** Up to 150 PSI (10.3 bar)

**Temperature Range** 35° to +200° F (+1.7° to +93.3° C)



**WARNING** These products can expose you to chemicals including CARBON BLACK, or LEAD, which are known to the state of California to cause cancer, and LEAD which is known to cause birth defects or other reproductive harm. For more information go to [www.P65Warnings.ca.gov](http://www.P65Warnings.ca.gov).



A

B

C

D

E

F

G

H

I

J

K

L

M

N

O

Click here for CADs, Product Specifications or to Configure Parts Online

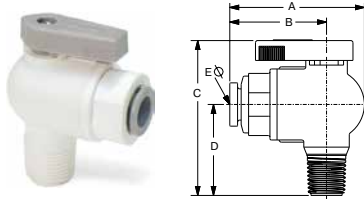

**VME - Valve Male Elbow**

PART NO.	NOM. TUBE O.D.	NPTF THREAD SIZE	A	B	C	D	Ø THRU HOLE MIN.
LFPP4VME2	1/4	1/8	1.74	1.21	2.00	1.10	.19
LFPP4VME4	1/4	1/4	1.74	1.21	2.18	1.28	.19
LFPP4VME6	1/4	3/8	1.74	1.21	2.18	1.28	.19
LFPP4VME8	1/4	1/2	1.74	1.21	2.37	1.47	.19
LFPP6VME2	3/8	1/8	1.85	1.32	2.00	1.10	.25
LFPP6VME4	3/8	1/4	1.85	1.32	2.18	1.28	.25
LFPP6VME6	3/8	3/8	1.85	1.32	2.18	1.28	.25
LFPP6VME8	3/8	1/2	1.85	1.32	2.37	1.47	.25

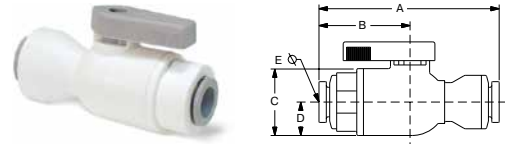

**VUC - Valve Union Connector Metric**

PART NO.	1 TUBE SIZE MM	2 TUBE SIZE MM	A MM	B MM	C MM	D MM	Ø THRU HOLE MIN. MM
LFPP6MVUC6M	6	6	.57	.27	.36	.13	.19
LFPP8MVUC8M	8	8	.60	.27	.36	.13	.25
LFPP10MVUC10M	10	10	.70	.33	.36	.13	.33
LFPP12MVUC12M	12	12	.88	.43	.36	.13	.37

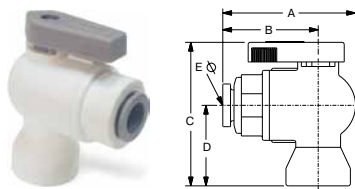

**VFE - Valve Female Elbow**

PART NO.	NOM. TUBE O.D.	NPTF THREAD SIZE	A	B	C	D	Ø THRU HOLE MIN.
LFPP4VFE2	1/4	1/8	1.74	1.21	1.82	.92	.19
LFPP4VFE4	1/4	1/4	1.74	1.21	2.05	1.15	.19
LFPP4VFE6	1/4	3/8	1.74	1.21	2.18	1.28	.19
LFPP6VFE2	3/8	1/8	1.85	1.32	1.82	.92	.25
LFPP6VFE4	3/8	1/4	1.85	1.32	2.05	1.15	.25
LFPP6VFE6	3/8	3/8	1.85	1.32	2.18	1.28	.25

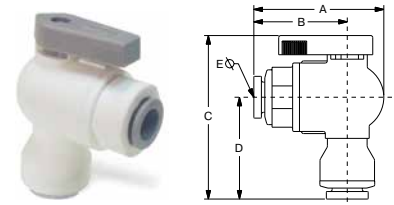

**VEU - Valve Elbow Union**

PART NO.	1 TUBE SIZE	2 TUBE SIZE	A	B	C	D	Ø THRU HOLE MIN.
LFPP4VEU4	1/4	1/4	1.75	1.22	2.33	1.42	.19
LFPP4VEU6	1/4	3/8	1.75	1.22	2.33	1.42	.11
LFPP6VEU4	3/8	1/4	1.83	1.30	2.32	1.40	.19
LFPP6VEU6	3/8	3/8	1.85	1.32	2.34	1.44	.25

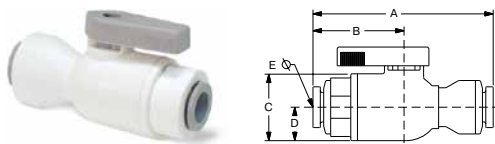

**VUC - Valve Union Connector**

PART NO.	1 TUBE SIZE	2 TUBE SIZE	A	B	C	D	Ø THRU HOLE MIN.
LFPP4VUC4	1/4	1/4	2.55	1.22	1.0	.5	.19
LFPP4VUC6	1/4	3/8	2.57	1.30	1.0	.5	.19
LFPP6VUC6	3/8	3/8	2.67	1.32	1.4	.5	.25

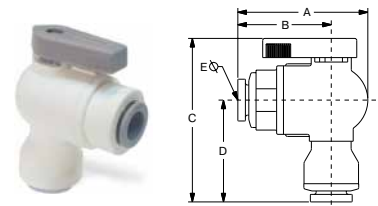

**VEU - Valve Elbow Union Metric**

PART NO.	1 TUBE SIZE MM	2 TUBE SIZE MM	A MM	B MM	C MM	D MM	Ø THRU HOLE MIN. MM
LFPP6MVEU6M	6	6	.41	.27	.55	.31	.19
LFPP8MVEU8M	8	8	.41	.28	.56	.33	.25
LFPP10MVEU10M	10	10	.48	.33	.61	.38	.33

NOTE: PPL refers to Polypropylene. FCB refers to Fluorocarbon.

**WARNING** These products can expose you to chemicals including CARBON BLACK, or LEAD, which are known to the state of California to cause cancer, and LEAD which is known to cause birth defects or other reproductive harm. For more information go to www.P65Warnings.ca.gov.



[Click here for CADs, Product Specifications or to Configure Parts Online](#)

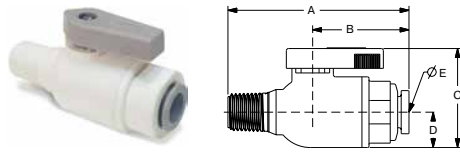
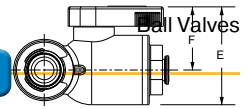

### VMC - Valve Male Connector

PART NO.	NOM. TUBE O.D.	NPTF THREAD SIZE	A	B	C	D	ØE THRU HOLE MIN.
LFPP4VMC4	1/4	1/4	2.40	1.21	1.4	.5	.19
LFPP4VMC6	1/4	3/8	2.40	1.21	1.4	.5	.19
LFPP4VMC8	1/4	1/2	2.59	1.21	1.4	.5	.19
LFPP6VMC2	3/8	1/8	2.33	1.32	1.4	.5	.25
LFPP6VMC4	3/8	1/4	2.51	1.32	1.4	.5	.25
LFPP6VMC6	3/8	3/8	2.51	1.32	1.4	.5	.25
LFPP6VMC8	3/8	1/2	2.70	1.32	1.4	.5	.25

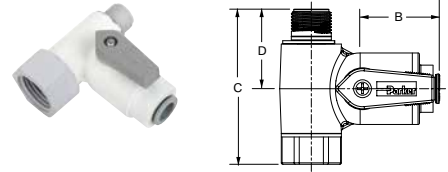

### VAS - Valve Angle Stop

PART NO.	TUBE O.D.	MALE THD.	FEMALE THD.	A	B	C	D	E	F
LFPP4VAS6	1/4	3/8	3/8	1.95	1.24	2.17	1.11	1.41	.91
LFPP4VAS8	1/4	3/8	1/2	1.95	1.24	2.40	1.11	1.41	.91
LFPP6VAS6	3/8	3/8	3/8	2.06	1.35	2.17	1.11	1.41	.91
LFPP6VAS8	3/8	3/8	1/2	2.06	1.35	2.40	1.11	1.41	.91

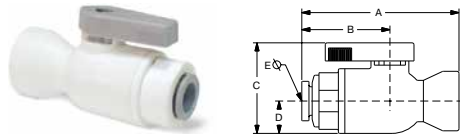

### VFC - Valve Female Connector

PART NO.	NOM. TUBE O.D.	NPTF THREAD SIZE	A	B	C	D	ØE THRU HOLE MIN.
LFPP4VFC2	1/4	1/8	2.04	1.21	1.4	.5	.19
LFPP4VFC4	1/4	1/4	2.27	1.21	1.4	.5	.19
LFPP4VFC6	1/4	3/8	2.40	1.21	1.4	.5	.19
LFPP6VFC2	3/8	1/8	2.15	1.32	1.4	.5	.25
LFPP6VFC4	3/8	1/4	2.38	1.32	1.4	.5	.25
LFPP6VFC6	3/8	3/8	2.51	1.32	1.4	.5	.25

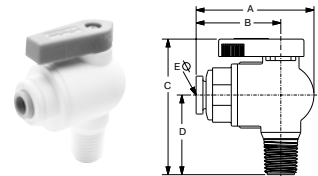

### VME - Valve Male Elbow

PART NUMBER	NOM. TUBE O.D.	NPTF THREAD SIZE	A	B	C	D	ØE THRU HOLE MIN.
PP4VME2-MG (+)	1/4	1/8	1.74	1.21	2.00	1.10	.19
PP4VME4-MG	1/4	1/4	1.74	1.21	2.18	1.28	.19
PP4VME6-MG	1/4	3/8	1.74	1.21	2.18	1.28	.19
PP4VME8-MG (+)	1/4	1/2	1.74	1.21	2.37	1.47	.19
PP6VME2-MG (+)	3/8	1/8	1.85	1.32	2.00	1.10	.25
PP6VME4-MG	3/8	1/4	1.85	1.32	2.18	1.28	.25
PP6VME6-MG	3/8	3/8	1.85	1.32	2.18	1.28	.25
PP6VME8-MG	3/8	1/2	1.85	1.32	2.37	1.47	.25

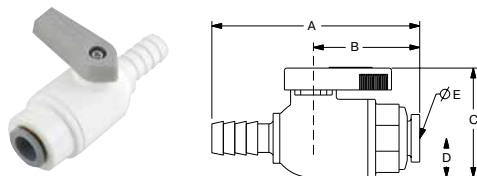

### VUCPB - Valve Union Connector Barbed x Tube

PART NO.	HOSE ID	TUBE OD	OD	A	B	C	D	ØE THRU HOLE MIN.
LFPP4VUCPB4	1/4	1/4	.31	2.40	1.08	1.42	.50	.15
LFPP6VUCPB6	3/8	3/8	.43	2.63	1.32	1.42	.50	.19

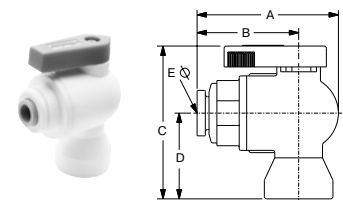

### VFE - Valve Female Elbow

PART NUMBER	NOM. TUBE O.D.	NPTF THREAD SIZE	A	B	C	D	ØE THRU HOLE MIN.
PP4VFE2-MG (+)	1/4	1/8	1.74	1.21	1.82	.92	.19
PP4VFE4-MG	1/4	1/4	1.74	1.21	2.05	1.15	.19
PP4VFE6-MG	1/4	3/8	1.74	1.21	2.18	1.28	.19
PP6VFE2-MG (+)	3/8	1/8	1.85	1.32	1.82	.92	.25
PP6VFE4-MG	3/8	1/4	1.85	1.32	2.05	1.15	.25
PP6VFE6-MG	3/8	3/8	1.85	1.32	2.18	1.28	.25

(+) Non Standard.

**WARNING** These products can expose you to chemicals including CARBON BLACK, or LEAD, which are known to the state of California to cause cancer, and LEAD which is known to cause birth defects or other reproductive harm. For more information go to [www.P65Warnings.ca.gov](http://www.P65Warnings.ca.gov).



[Click here for CADs, Product Specifications or to Configure Parts Online](#)

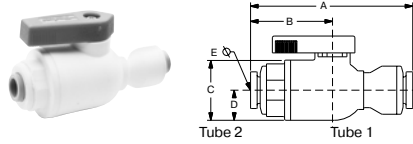

### VUC - Valve Union Connector

PART NUMBER	1 TUBE SIZE	2 TUBE SIZE	A	B	C	D	ØE THRU HOLE MIN.
PP4VUC4-MG	1/4	1/4	2.55	1.22	1.0	.5	.19
PP4VUC6-MG	1/4	3/8	2.55	1.22	1.0	.5	.19
PP6VUC4-MG	3/8	1/4	2.57	1.30	1.0	.5	.19
PP6VUC6-MG	3/8	3/8	2.67	1.32	1.4	.5	.25

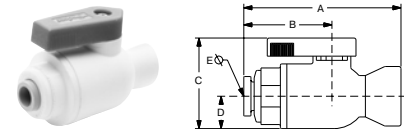

### VFC - Valve Female Connector

PART NUMBER	NOM. TUBE O.D.	NPTF THREAD SIZE	A	B	C	D	ØE THRU HOLE MIN.
PP4VFC2-MG	1/4	1/8	2.04	1.21	1.4	.5	.19
PP4VFC4-MG	1/4	1/4	2.27	1.21	1.4	.5	.19
PP4VFC6-MG	1/4	3/8	2.40	1.21	1.4	.5	.19
PP6VFC2-MG	3/8	1/8	2.15	1.32	1.4	.5	.25
PP6VFC4-MG	3/8	1/4	2.38	1.32	1.4	.5	.25
PP6VFC6-MG	3/8	3/8	2.51	1.32	1.4	.5	.25

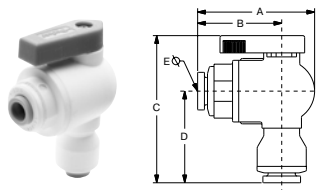

### VEU - Valve Elbow Union

PART NUMBER	1 TUBE SIZE	2 TUBE SIZE	A	B	C	D	ØE THRU HOLE MIN.
PP4VEU4-MG	1/4	1/4	1.75	1.22	2.33	1.42	.19
PP4VEU6-MG	1/4	3/8	1.75	1.22	2.33	1.42	.11
PP6VEU4-MG	3/8	1/4	1.83	1.30	2.32	1.40	.19
PP6VEU6-MG	3/8	3/8	1.85	1.32	2.34	1.44	.25

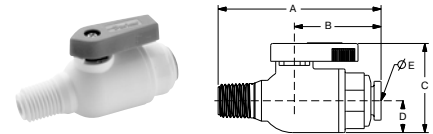

### VMC - Valve Male Connector

PART NUMBER	NOM. TUBE O.D.	NPTF THREAD SIZE	A	B	C	D	ØE THRU HOLE MIN.
PP4VMC2-MG (+)	1/4	1/8	2.22	1.21	1.4	.5	.19
PP4VMC4-MG	1/4	1/4	2.40	1.21	1.4	.5	.19
PP4VMC6-MG	1/4	3/8	2.40	1.21	1.4	.5	.19
PP4VMC8-MG (+)	1/4	1/2	2.59	1.21	1.4	.5	.19
PP6VMC2-MG (+)	3/8	1/8	2.33	1.32	1.4	.5	.25
PP6VMC4-MG	3/8	1/4	2.51	1.32	1.4	.5	.25
PP6VMC6-MG	3/8	3/8	2.51	1.32	1.4	.5	.25
PP6VMC8-MG (+)	3/8	1/2	2.70	1.32	1.4	.5	.25

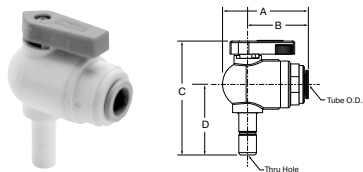

### VTEU - Valve Tube Elbow Union

PART NUMBER	NOM. TUBE O.D.	STEM	A	B	C	D	ØE THRU HOLE MIN.
PP4VTEU6-MG	1/4	3/8	1.75	1.22	2.43	1.50	.17
PP6VTEU6-MG	3/8	3/8	1.83	1.30	2.43	1.50	.25

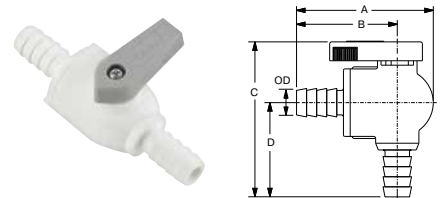

### VEU - Parbarb Elbow Ball Valve

PART NO.	HOSE I.D.	O.D.	A	B	C	D	ØE THRU HOLE MIN.
PBPP4VEU4	1/4	.31	2.13	1.57	2.32	1.40	.15
PBPP6VEU6	3/8	.43	2.13	1.60	2.32	1.40	.25
PBPP8VEU8	1/2	.55	2.13	1.60	2.32	1.40	.25

**WARNING** These products can expose you to chemicals including CARBON BLACK, or LEAD, which are known to the state of California to cause cancer, and LEAD which is known to cause birth defects or other reproductive harm. For more information go to [www.P65Warnings.ca.gov](http://www.P65Warnings.ca.gov).



[Click here for CADs, Product Specifications or to Configure Parts Online](#)

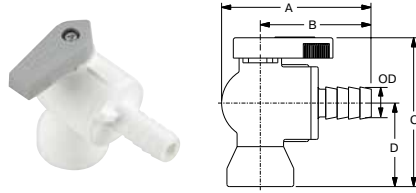

**VFE - Valve Barbed Female Elbow**

PART NO.	HOSE I.D.	NPTF THD.	O.D.	A	B	C	D	ØE THRU HOLE MIN.
PBPP4VFE4	1/4	1/4	.31	2.13	1.60	2.05	1.15	.15
PBPP6VFE4	3/8	1/4	.43	2.13	1.60	2.05	1.15	.15
PBPP6VFE6	3/8	3/8	.43	2.13	1.60	2.18	1.28	.19

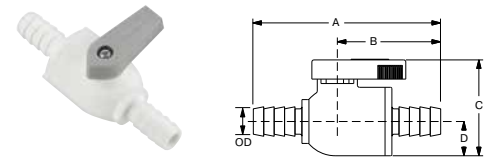

**VUC - Valve Barbed Union Connector**

PART NO.	HOSE I.D.	O.D.	A	B	C	D	ØE THRU HOLE MIN.
PBPP4VUC4	1/4	.31	2.91	1.60	1.42	.50	.15
PBPP6VUC6	3/8	.43	2.91	1.60	1.42	.50	.19
PBPP8VUC8	1/2	.55	2.91	1.60	1.42	.50	.25

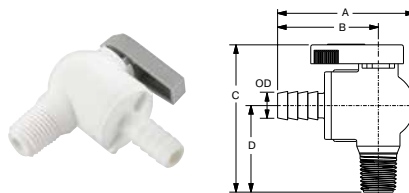

**VME - Valve Barbed Male Elbow**

PART NO.	HOSE I.D.	NPTF THD.	O.D.	A	B	C	D	ØE THRU HOLE MIN.
PBPP4VME4	1/4	1/4	.31	2.13	1.60	2.18	1.28	.15
PBPP6VME6	3/8	3/8	.43	2.13	1.60	2.18	1.28	.19

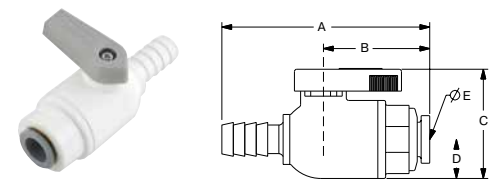

**VUCPB - Valve Union Connector Barbed x Tube**

PART NO.	HOSE ID	TUBE OD	OD	A	B	C	D	ØE THRU HOLE MIN.
LFPP4VUCPB4	1/4	1/4	.31	2.40	1.08	1.42	.50	.15
LFPP6VUCPB6	3/8	3/8	.43	2.63	1.32	1.42	.50	.19

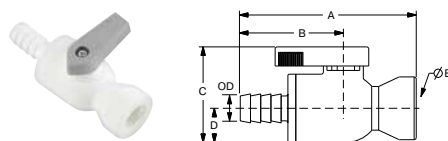

**VFC - Valve Barbed Female Connector**

PART NO.	HOSE I.D.	NPTF THD.	O.D.	A	B	C	D	ØE THRU HOLE MIN.
PBPP4VFC4	1/4	1/4	.31	2.76	1.60	1.41	.50	.15
PBPP6VFC6	3/8	3/8	.43	2.79	1.60	1.41	.50	.19

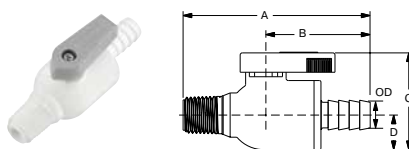

**VMC - Valve Barbed Male Connector**

PART NO.	HOSE I.D.	NPTF THD.	O.D.	A	B	C	D	ØE THRU HOLE MIN.
PBPP4VMC4	1/4	1/4	.31	2.79	1.60	1.42	.50	.15
PBPP6VMC6	3/8	3/8	.43	2.79	1.60	1.42	.50	.19

**BVC Ball Valve Clip**

BV-Clip Shown below holding VUCPB and VME

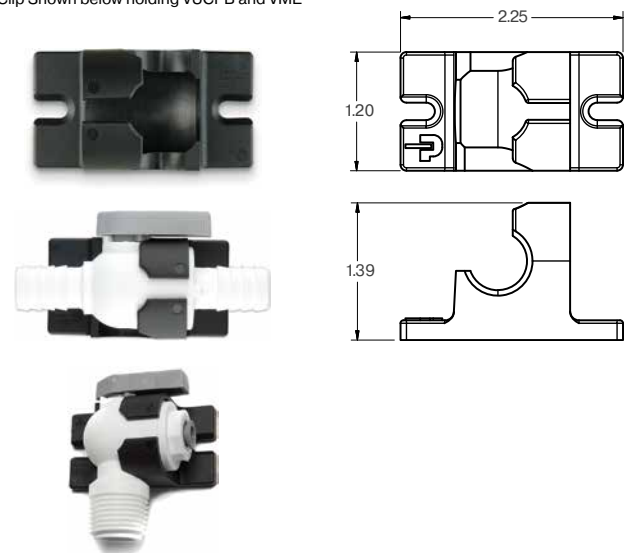

**WARNING** These products can expose you to chemicals including CARBON BLACK, or LEAD, which are known to the state of California to cause cancer, and LEAD which is known to cause birth defects or other reproductive harm. For more information go to [www.P65Warnings.ca.gov](http://www.P65Warnings.ca.gov).

- A
- B
- C
- D
- E
- F
- G
- H
- I
- J
- K
- L
- M
- N
- O

[Click here for CADs, Product Specifications or to Configure Parts Online](#)

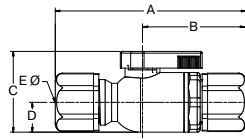

**VUC - Valve Union Connector**

PART NO.	1 TUBE SIZE	2 TUBE SIZE	A	B	C	D	ØE THRU HOLE MIN.
FTPPB4VUC4	1/4	1/4	2.94	1.61	1.4	.5	.19
FTPPB4VUC6	1/4	3/8	3.07	1.61	1.4	.5	.19
FTPPB6VUC6	3/8	3/8	3.19	1.73	1.4	.5	.25
FTPPB8VUC8	1/2	1/2	3.27	1.80	1.4	.5	.38

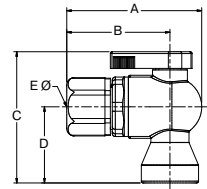

**VFE - Valve Female Elbow**

PART NO.	1 TUBE SIZE	NPTF THD SIZE	A	B	C	D	ØE THRU HOLE MIN.
FTPPB4VFE4	1/4	1/4	2.14	1.61	2.18	1.25	.19
FTPPB6VFE4	3/8	1/4	2.26	1.73	2.18	1.25	.19
FTPPB6VFE6	3/8	3/8	2.26	1.73	2.21	1.28	.25
FTPPB8VFE6	1/2	3/8	2.34	1.8	2.21	1.28	.25

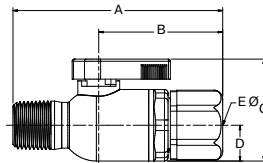

**VMC - Valve Male Connector**

PART NO.	1 TUBE SIZE	NPTF THD SIZE	A	B	C	D	ØE THRU HOLE MIN.
FTPPB4VMC4	1/4	1/4	2.81	1.61	1.4	.5	.19
FTPPB4VMC6	1/4	3/8	2.81	1.61	1.4	.5	.19
FTPPB6VMC4	3/8	1/4	2.93	1.73	1.4	.5	.19
FTPPB6VMC6	3/8	3/8	2.93	1.73	1.4	.5	.25
FTPPB8VMC6	1/2	3/8	3.00	1.79	1.4	.5	.25

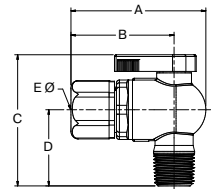

**VME - Valve Male Elbow**

PART NO.	1 TUBE SIZE	NPTF THD SIZE	A	B	C	D	ØE THRU HOLE MIN.
FTPPB4VME4	1/4	1/4	2.14	1.61	2.21	1.28	.19
FTPPB6VME4	3/8	1/4	2.26	1.73	2.21	1.28	.19
FTPPB6VME6	3/8	3/8	2.26	1.73	2.21	1.28	.25
FTPPB8VME8	1/2	1/2	2.34	1.8	2.4	1.47	.38

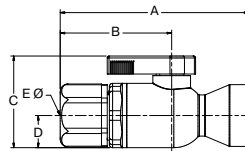

**VFC - Valve Female Connector**

PART NO.	1 TUBE SIZE	NPTF THD SIZE	A	B	C	D	ØE THRU HOLE MIN.
FTPPB4VFC4	1/4	1/4	2.78	1.61	1.4	.5	.19
FTPPB6VFC6	3/8	3/8	2.93	1.73	1.4	.5	.25
FTPPB8VFC6	1/2	3/8	3.00	1.8	1.4	.5	.25

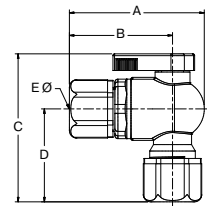

**VEU - Valve Elbow Union**

PART NO.	1 TUBE SIZE	2 TUBE SIZE	A	B	C	D	ØE THRU HOLE MIN.
FTPPB4VEU4	1/4	1/4	2.14	1.61	2.35	1.42	.19
FTPPB6VEU4	3/8	1/4	2.26	1.73	2.37	1.44	.19
FTPPB6VEU6	3/8	3/8	2.26	1.73	2.49	1.56	.25
FTPPB8VEU8	1/2	1/2	2.34	1.8	2.47	1.54	.38

**WARNING** These products can expose you to chemicals including CARBON BLACK, or LEAD, which are known to the state of California to cause cancer, and LEAD which is known to cause birth defects or other reproductive harm. For more information go to [www.P65Warnings.ca.gov](http://www.P65Warnings.ca.gov).





# Plug Valves Series PV

## Product Features:

- Extruded Brass Body
- One Piece Stem/Handle
- Acetal Stem/Handle
- 100% Leak Tested

## Style:

- PV-Plug Valve

## Type:

- 607-Male/Male
- 608-Male/Female
- 609-Female/Female

## Specifications:

### Pressure Range:

- Up to 250 PSI (17.2 bar)

### Temperature Range

- -40° to +175° F (-40° to +79.4° C)

## Valve Components

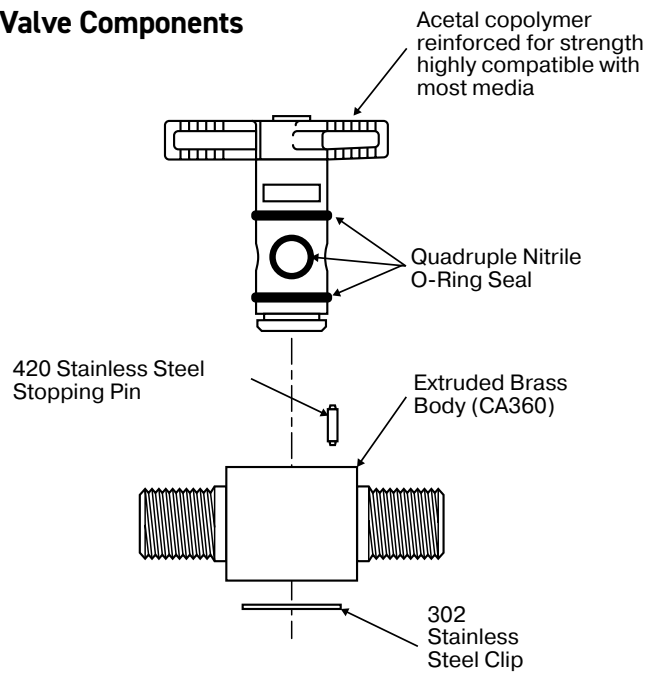

## Assembly Instructions

To assure sealability and reliable performance, the valve must be installed so that the flow media travels in the direction of the arrow on the valve handle.



**WARNING** These products can expose you to chemicals including NICKEL or LEAD, which are known to the state of California to cause cancer, and LEAD which is known to cause birth defects or other reproductive harm. For more information go to [www.P65Warnings.ca.gov](http://www.P65Warnings.ca.gov).



[Click here for CADs, Product Specifications or to Configure Parts Online](#)

- A
- B
- C
- D
- E
- F
- G
- H
- I
- J
- K
- L
- M
- N
- O

### Male Pipe to Male Pipe Plug Valve PV607

PART NO.	PIPE THREAD	H	L	M	N	N1	FLOW DIA. D
PV607-2	1/8	.67	1.34	1.66	1.38	.51	.200
PV607-4	1/4	.67	1.34	2.02	1.38	.51	.200

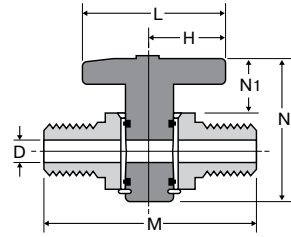

### Female Pipe to Male Pipe Plug Valve PV608

PART NO.	PIPE THREAD	H	L	M	N	N1	FLOW DIA. D
PV608-2	1/8	.67	1.34	1.67	1.38	.51	.200
PV608-4	1/4	.67	1.34	2.06	1.38	.51	.200

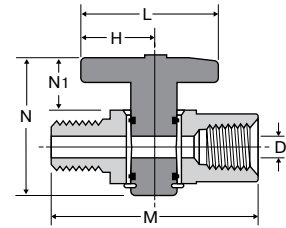

### Female Pipe to Female Pipe Plug Valve PV609

PART NO.	PIPE THREAD	H	L	M	N	N1	FLOW DIA. D
PV609-2	1/8	.67	1.34	1.68	1.38	.51	.200
PV609-4	1/4	.67	1.34	2.10	1.38	.51	.200

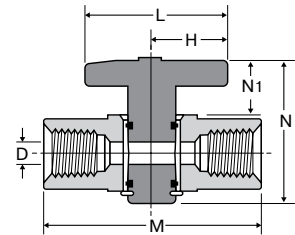

### Mounting Bracket PVMB-001

PART NO.	H	M	N	N1	D
PVMB-001	.68	1.86	.90	.45	.135

Note: 1" diameter hole required in panel when using mounting bracket

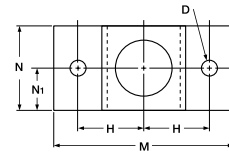

**WARNING** These products can expose you to chemicals including NICKEL or LEAD, which are known to the state of California to cause cancer, and LEAD which is known to cause birth defects or other reproductive harm. For more information go to [www.P65Warnings.ca.gov](http://www.P65Warnings.ca.gov).



# Ball Valves Rotary Actuator Series ACT



## Product Features:

- One Piece Aluminum Extrusion Body
- PTFE Seals
- Stainless Steel Shaft
- Self Lubricated Vane Seal
- Anodized Aluminum Extrusion Vane

## Specifications:

### Pressure Range:

- 150 PSI (10.3 bar)  
Maximum Air Pressure to Actuator
- Vacuum service 28 inches Hg

### Temperature Range

- -40° to +180° F (-40° to +82.2° C)

## How Do Vane Actuators Work?

Parker vane actuators provide the maximum amount of output torque from the smallest possible envelope size. They convert fluid power pressure into rotary motion for a wide variety of industrial applications. Double vane units produce twice the torque output of single vane actuators from identical envelope dimensions and have a maximum rotation of 95°.

A short cylindrical chamber encloses a vane attached to a central shaft. Fluid pressure differential is applied through a stationary barrier (stator) within the cylinder to one side of the vane. The opposite side of the vane is connected to exhaust through the stator. This pressure differential produces rotation of the vane and central shaft. Due to vane actuator design there will always be some internal bypass in these units.

## Rotary Actuator Series ACT Features (See figure 1, next page)

- 1. Heads** - are precision machined from aluminum, then hard-coat anodized and PTFE impregnated to ensure long seal life and low breakaway pressure.
- 2. Body** - is machined from a one-piece aluminum extrusion that incorporates the stator for superior rigidity. The extrusion is hard-coat anodized and PTFE impregnated, resulting in a smooth, slick seal surface which guarantees long seal life and low breakaway pressure.
- 3. Shoulder Seal** - a nitrile-energized, PTFE seal is used to reduce bypass flow and friction, providing superior performance and long life.
- 4. Shaft Seal** - the high-quality, self-lubricated, abrasion-resistant nitrile seal is a multiple lobe construction for leakfree operation and greater reliability.
- 5. Shaft** - stainless steel provides high strength and corrosion resistance for the most demanding applications.
- 6. Bearings** - hard-coat anodized aluminum-bearing surface with permanent solid film lubricant provides substantial shaft support and wear resistance, ensuring continuous lubrication, high performance, and long life.
- 7. Mounting** - combination face and base mounting offer flexibility in application and design.
- 8. Vane Seal** - a special self-lubricated, abrasion-resistant nitrile compound is molded into a one-piece vane seal, providing low breakaway pressure and long life, even with no lubrication. The vane seal is also removable so that field repairs can be made, if necessary.
- 9. Vane** - a hard-coat anodized aluminum extrusion permanently affixed to shaft, forming a structurally sound assembly. The light weight also reduces inertia allowing faster operating speeds.

**WARNING** These products can expose you to chemicals including NICKEL or LEAD, which are known to the state of California to cause cancer, and LEAD which is known to cause birth defects or other reproductive harm. For more information go to [www.P65Warnings.ca.gov](http://www.P65Warnings.ca.gov).



A

B

C

D

E

F

G

H

I

J

K

L

M

N

O

[Click here for CADs, Product Specifications or to Configure Parts Online](#)

Rotary Actuator Series ACT Features Figure 1

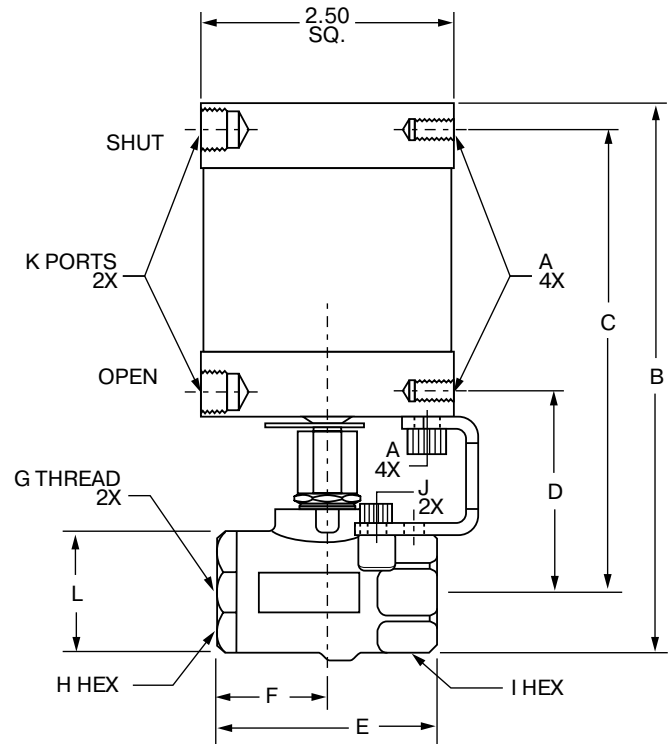
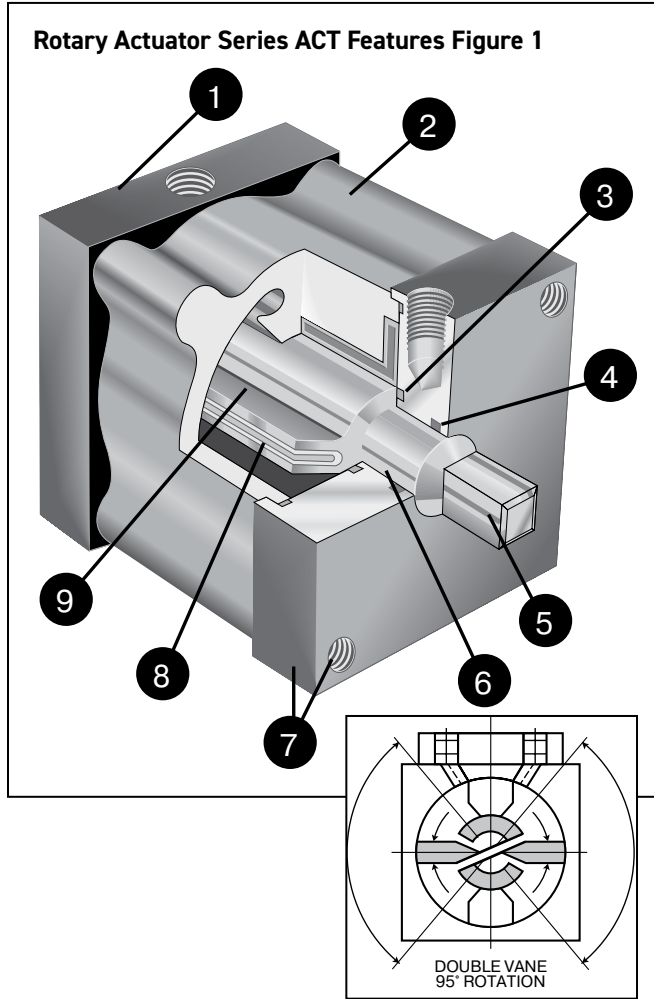

**Rotary Actuator, Female Pipe Ends V502P-X-ACT**

PART NO.	SIZE	A MTG. HOLES	B	C	D	E	F	G	H HEX	I HEX	J UNC	K NPTF	L	FLOW DIA.	FLOW CV	MIN. ACT PRESSURE (PSI)
V502P-4-ACT	1/4	1/4-20 UNC	5.25	4.47	1.91	2.03	1.00	1/4-18PTF	15/16	15/16	10-24	1/8-27	1.06	.375	4.0	50
V502P-6-ACT	3/8	1/4-20 UNC	5.25	4.47	1.91	2.03	1.00	3/8-18PTF	15/16	15/16	10-24	1/8-27	1.06	.375	5.8	50
V502P-8-ACT	1/2	1/4-20 UNC	5.38	4.54	1.98	2.20	1.09	1/2-14PTF*	1-1/16	1-1/16	10-24	1/8-27	1.19	.500	12.0	50
V502P-12-ACT	3/4	1/4-20 UNC	5.57	4.63	2.07	2.42	1.29	3/4-14PTF**	1-5/16	1-1/4	10-24	1/8-27	1.38	.685	25.0	75
V502P-16-ACT	1	1/4-20 UNC	5.85	4.76	2.20	2.75	1.38	1-11.5PTF**	1-9/16	1-1/2	10-24	1/8-27	1.67	.875	35.0	75

**Stainless Steel Rotary Actuator, Female Pipe Ends V502SS-X-ACT**

PART NO.	SIZE	A MTG. HOLES	B	C	D	E	F	G	H/I HEX	J	K NPTF	L	FLOW DIA.	FLOW CV
V502SS-4-ACT	1/4	1/4-20 UNC	5.41	4.61	2.05	2.07	1.04	1/4-18 NPT	15/16	10-24	1/8-27	1.10	.375	4.0
V502SS-6-ACT	3/8	1/4-20 UNC	5.41	4.61	2.05	2.07	1.04	3/8-18 NPT	15/16	10-24	1/8-27	1.10	.375	6.0
V502SS-8-ACT	1/2	1/4-20 UNC	5.53	4.64	2.08	2.27	1.17	1/2-14 NPT	1 1/16	10-24	1/8-27	1.28	.500	14.0

\*Ptf Special Short. \*\*Ptf Special Extra Short

**WARNING** These products can expose you to chemicals including NICKEL or LEAD, which are known to the state of California to cause cancer, and LEAD which is known to cause birth defects or other reproductive harm. For more information go to [www.P65Warnings.ca.gov](http://www.P65Warnings.ca.gov).



[Click here for CADs, Product Specifications or to Configure Parts Online](#)

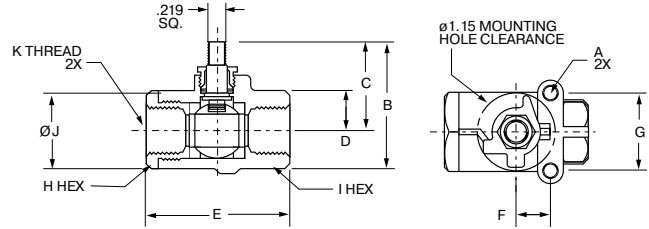

**Actuator Sub-Assembly V502P-X-SUB**

PART NO	SIZE	A UNC	B	C	D	E	F	G	H HEX	I HEX	J	K
V502P-4-SUB	1/4	10-24	1.68	1.15	.495	2.03	.50	1.12	15/16	15/16	1.06	1/4-18 PTF
V502P-6-SUB	3/8	10-24	1.68	1.15	.495	2.03	.50	1.12	15/16	15/16	1.06	3/8-18 PTF
V502P-8-SUB	1/2	10-24	1.78	1.19	.565	2.20	.50	1.12	1-1/16	1-1/16	1.19	1/2-14 PTF*
V502P-12-SUB	3/4	10-24	2.09	1.40	.655	2.42	.87	1.37	1-5/16	1-1/4	1.38	3/4-14 PTF**
V502P-16-SUB	1	10-24	2.38	1.54	.785	2.75	.87	1.37	1-9/16	1-1/2	1.67	1-11.5 PTF**

\* PTF Special Short  
 \*\* PTF Special Extra Short

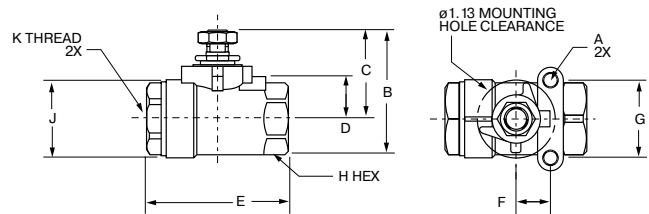

**Actuator Sub-Assembly V502SS-X-SUB**

PART NO	SIZE	A UNC	B	C	D	E	F	G	H HEX	J	K
V502SS-4-SUB	1/4	10-24	1.88	1.32	.63	2.07	.50	1.12	15/16	1.10	1/4-18 NPT
V502SS-6-SUB	3/8	10-24	1.88	1.32	.63	2.07	.50	1.12	15/16	1.10	3/8-18 NPT
V502SS-8-SUB	1/2	10-24	2.00	1.35	.66	2.27	.50	1.12	1-1/16	1.28	1/2-14 NPT

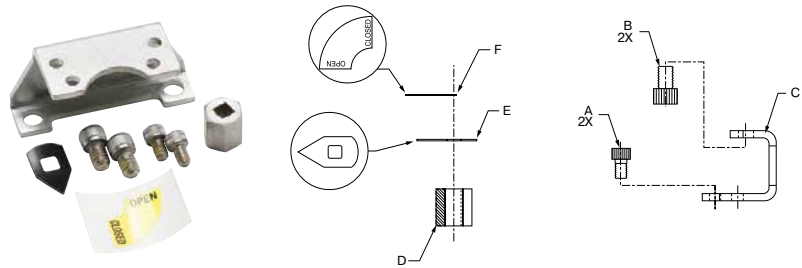

**ACT-P-X-KIT**

PART NO.	FOR USE WITH	A	B	C	D	E	F
ACT-P-1-KIT	V502P-4, 6, 8-ACT	10-24 UNC	1/4-20 UNC	BRACKET	.60 LONG COUPLING	POSITION INDICATOR	POSITION LABEL
ACT-P-2-KIT	V502P-12, 16-ACT	10-24 UNC	1/4-20 UNC	BRACKET	.55 LONG COUPLING	POSITION INDICATOR	POSITION LABEL

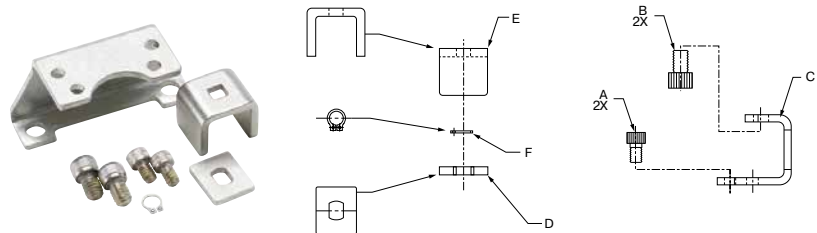

**ACT-SS-X-KIT**

PART NO.	FOR USE WITH	A	B	C	D	E	F
ACT-SS-1-KIT	V502SS-4, 6, 8-ACT	10-24 UNC	1/4-20 UNC	BRACKET	CLIP	HANDLE YOKE	SNAP RING

**WARNING** These products can expose you to chemicals including NICKEL or LEAD, which are known to the state of California to cause cancer, and LEAD which is known to cause birth defects or other reproductive harm. For more information go to [www.P65Warnings.ca.gov](http://www.P65Warnings.ca.gov).



A

B

C

D

E

F

G

H

I

J

K

L

M

N

O

# Ball Valve Series BVGL



## Product Features:

- Nickel plated brass body
- Chrome plated brass ball
- PTFE seats/seals
- Fluorocarbon stem seal

## Specifications:

- Female threads manufactured in accordance to DIN 2999/ISO 228

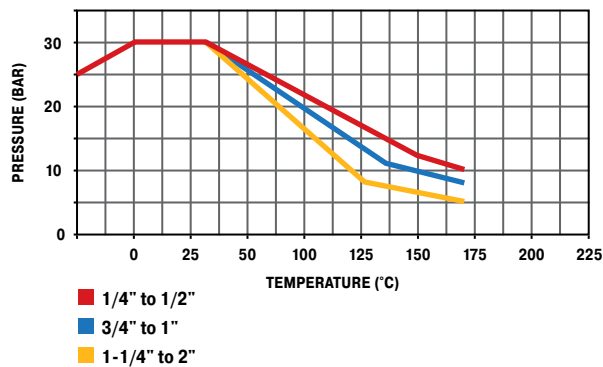

## Advantages

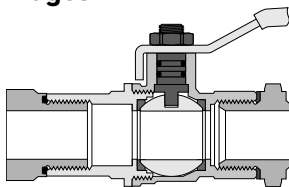

### Long female threads

BVGL series valves are manufactured with long female threads in accordance to DIN 2999/ISO 228. This enables the valves to be used with Prestolok and brass adaptors but also Parker's range of steel hydraulic fittings, e.g. Triple-Lok, O-Lok, EO, and BSPP coned adaptors.

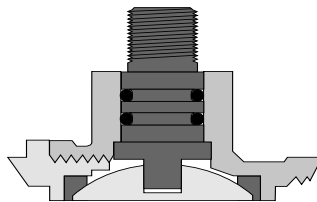

### Anti extrusion stem

The BVGL series ball valves are fitted with an anti extrusion stem to prevent blow out in the case of pressure peaks. The stem is sealed with two Fluorocarbon O-rings for maximum safety and performance.

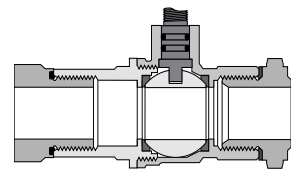

### Full flow

All BVGL series valves are full-flow. This limits the turbulence created by the passage of fluid across the valve, minimizing pressure drop.

**WARNING** These products can expose you to chemicals including NICKEL or LEAD, which are known to the state of California to cause cancer, and LEAD which is known to cause birth defects or other reproductive harm. For more information go to [www.P65Warnings.ca.gov](http://www.P65Warnings.ca.gov).



### BVGL BSPP Female/Female Valve with Lever Handle

PART NO.	DN MM	THREAD BSPP	C	H	L	L1	O
BVG4-1/4L	8	1/4	20	38	50	82	25.0
BVG4-3/8L	10	3/8	20	38	60	82	25.0
BVG4-1/2L	15	1/2	25	43	75	100	32.5
BVG4-3/4L	20	3/4	32	50	80	120	39.0
BVG4-1L	25	1	41	54	90	120	47.5
BVG4-1.1/4L	32	1 1/4	50	73	110	158	59.0
BVG4-1.1/2L	40	1 1/2	55	79	120	158	71.5
BVG4-2L	50	2	70	86	140	158	86.0

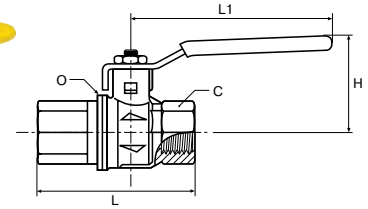

### BVGT4 BSPP Female/Female Valve with Compact Handle

PART NO.	DN MM	THREAD BSPP	C	H	L	L1	O
BVGT4-1/4L	8	1/4	20	39	50	50	25.0
BVGT4-3/8L	10	3/8	20	39	60	50	25.0
BVGT4-1/2L	15	1/2	25	43	75	50	32.5
BVGT4-3/4L	20	3/4	32	47	80	60	39.0
BVGT4-1L	25	1	41	51	90	60	47.5

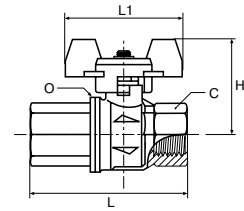

A

B

C

D

E

F

G

H

I

J

K

L

M

N

O

**WARNING** These products can expose you to chemicals including NICKEL or LEAD, which are known to the state of California to cause cancer, and LEAD which is known to cause birth defects or other reproductive harm. For more information go to [www.P65Warnings.ca.gov](http://www.P65Warnings.ca.gov).



A

B

C

D

E

F

G

H

I

J

K

L

M

N

O

# Ball Valve Series BVGLOCK



## Product Features:

- Nickel plated brass body
- Chrome plated brass ball
- PTFE seats /seals
- PTFE packing gland
- Carbon steel handle

## Specifications:

- Meets the requirements of European directive DI 89/392/CEE relating to the isolation of power supply and to meet the health and safety requirements for machines and materials in paragraphs L233-5 of the code DU Travail.

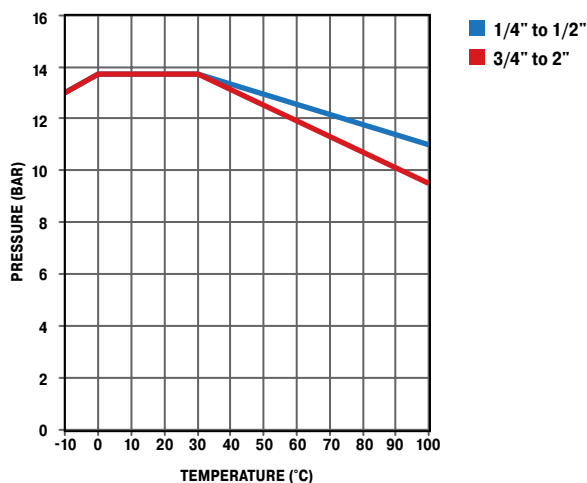

**WARNING** These products can expose you to chemicals including NICKEL or LEAD, which are known to the state of California to cause cancer, and LEAD which is known to cause birth defects or other reproductive harm. For more information go to [www.P65Warnings.ca.gov](http://www.P65Warnings.ca.gov).



### Advantages

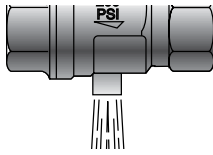

#### Threaded Exhaust

BVGLOCK series ball valves are manufactured with an exhaust port, this safety feature enables the downstream air pressure to be vented when the valve is closed. 1/4-1" have M5 thread. 1.1/4 and larger are not threaded.

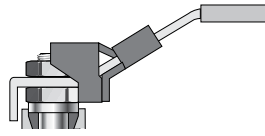

#### Lockable Handle

The BVGLOCK series ball valves are fitted with a handle that can be locked in the closed position with a padlock. This safety feature ensures the valve cannot be accidentally opened, and only authorized personnel can operate the valve.

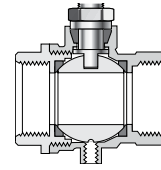

#### DIN 2999 / ISO 228 Female Threads

BVGLOCK series valves are manufactured with long female threads in accordance to DIN2999/ISO228. This enables the valves to be used with Prestolok and brass adaptors but also Parker's range of steel hydraulic fittings and EO-fittings form "A" or "C" to DIN 3852.

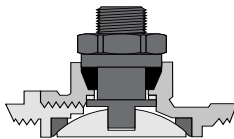

#### Anti Extrusion Stem

The BVGLOCK series ball valves are fitted with an anti-extrusion stem to prevent blow out in the case of pressure peaks.

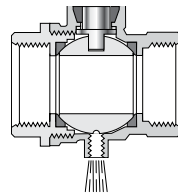

#### Full Flow

All BVGLOCK series valves are full-flow. This limits the turbulence created by the passage of fluid across the valve, minimizing pressure drop.

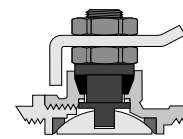

#### Adjustable Packing

The PTFE packing gland and adjustable washer are designed to give longer service life and lower operating torques.

### BVG4PLOCK BSSP Female/Female, Vented, Locking Handle

PART NO.	D FLOW Ø	THREAD BSSP	C	G	H	I	L	L1	N
BVG4P-1/4 LOCK	8.0	1/4	20	22.5	47.5	12.0	45	96	M5
BVG4P-3/8 LOCK	9.5	3/8	20	22.5	47.5	12.0	45	96	
BVG4P-1/2 LOCK	15.0	1/2	25	29.5	52.0	15.5	59	96	
BVG4P-3/4 LOCK	19.0	3/4	31	32.0	59.5	17.0	64	117	
BVG4P-1 LOCK	24.0	1	40	40.5	63.5	21.0	81	117	
BVG4P-1.1/4 LOCK	32.0	1-1/4	49	46.5	76.5	23.0	93	158	G1/4
BVG4P-1.1/2 LOCK	40.0	1-1/2	54	51.0	82.5	23.0	102	158	
BVG4P-2 LOCK	50.0	2	69	60.5	89.5	26.5	121	158	

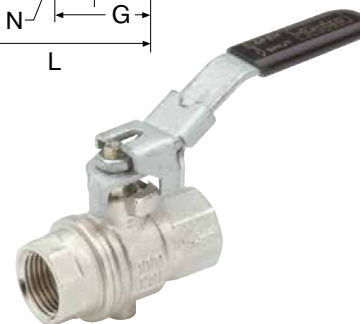
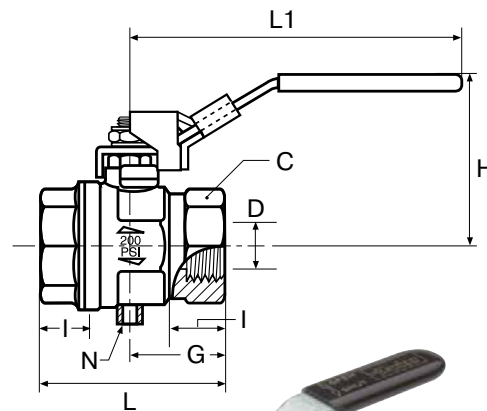

**WARNING** These products can expose you to chemicals including NICKEL or LEAD, which are known to the state of California to cause cancer, and LEAD which is known to cause birth defects or other reproductive harm. For more information go to [www.P65Warnings.ca.gov](http://www.P65Warnings.ca.gov).



A

B

C

D

E

F

G

H

I

J

K

L

M

N

O

# Axial Valves



Parker's Axial Valve incorporates both the valve and actuation function. With pneumatic or electro-pneumatic control, it avoids many of the restrictions associated with traditional actuators.

## Product Features:

- Compact, up to 50% smaller than valves with separate actuators
- Simple to install
- Common sub-base for solenoid control
- Automation of the open/close function
- Operation independent of the upstream and downstream pressure in the circuit

## Applications:

- Injection Molding
- Pneumatics
- Packaging
- Textile
- Printing
- Robotics

## Specifications:

### Pressure Range:

- Up to 150 PSI (10.3 bar)

### Vacuum Service:

- 29 in Hg

### Pilot Pressure:

- NC: 60 to 115 PSI (4.1 to 7.9 bar)

### Temperature Range:

- -4° to +275° F (-20° to +135° C)

## Water at ambient temperature under a 1 bar differential pressure.

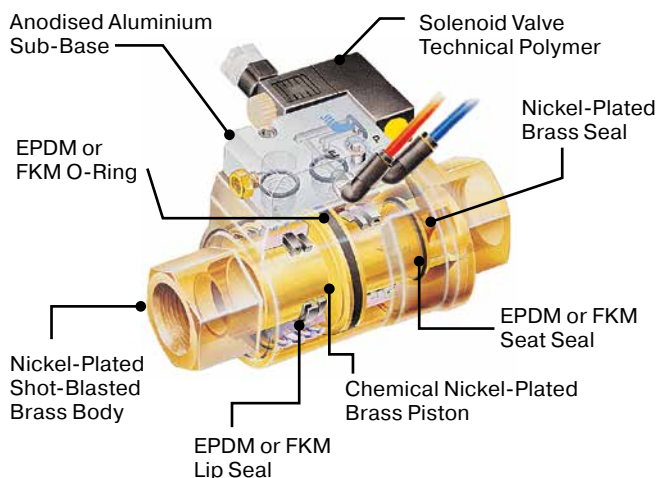
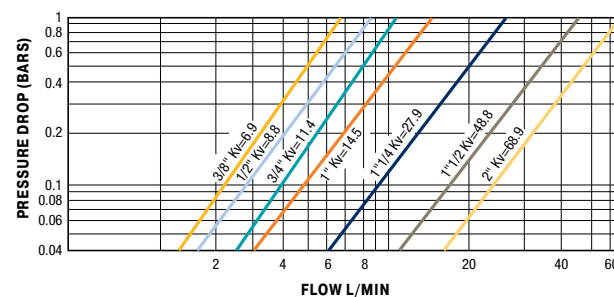

**WARNING** These products can expose you to chemicals including NICKEL or LEAD, which are known to the state of California to cause cancer, and LEAD which is known to cause birth defects or other reproductive harm. For more information go to [www.P65Warnings.ca.gov](http://www.P65Warnings.ca.gov).





### Operation

Depending on operational requirement, air is passed into the actuation chamber to open or close the valve.

#### Normally Closed Axial Valve (NC)

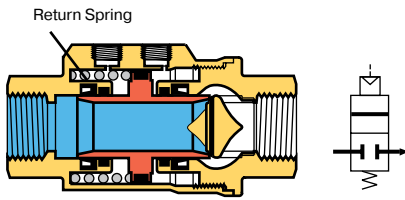

**Rest State (Valve Closed)**

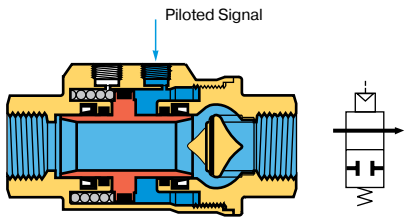

**Piloted State (Valve Open)**

#### Normally Open Axial Valve (NO)

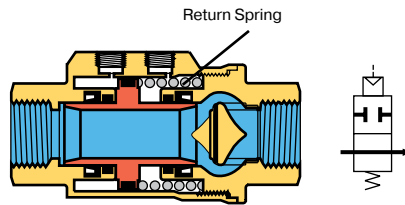

**Rest State (Valve Open)**

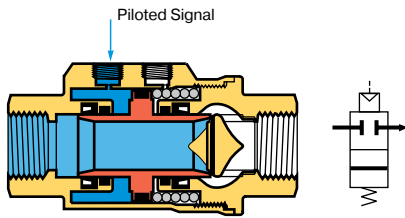

**Piloted State (Valve Closed)**

#### Double-Acting Axial Valve (DE)

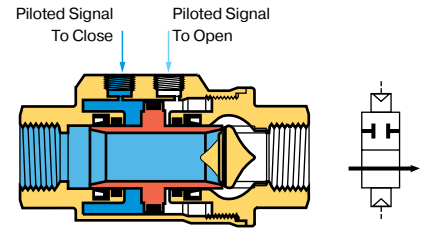

**Piloted State (Valve Closed)**

### Installation Options

The Parker axial valve offers 3 different control methods dependant on the requirements of the installation:

#### Pneumatic Control

**Example:** Double-acting axial valve 4222

- Local compressed air control
- For repetitive on/off cycles
- Remote control where access to the machine is difficult
- For explosive or explosion prevention areas

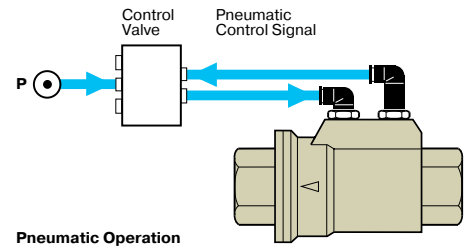

#### Electro-Pneumatic Control

**Example:** Normally closed axial valve 4202

- Sub-base and mini-solenoid valve 4298
- For automated industrial systems requiring remote control
- Namur seating plane solenoid valve

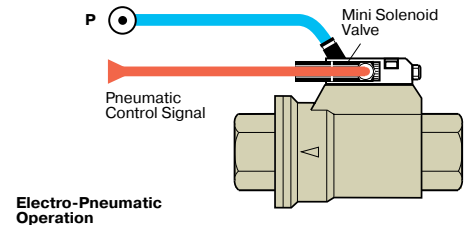

#### Dual Pneumatic and Electro-Pneumatic Control

**Example:** Normally open axial valve 4212

- Sub-base and mini-solenoid valve 4298
- Pneumatic push-button 4299
- Dual control structure
- For increased safety: prevents localised operating errors
- Namur seating plane solenoid valve

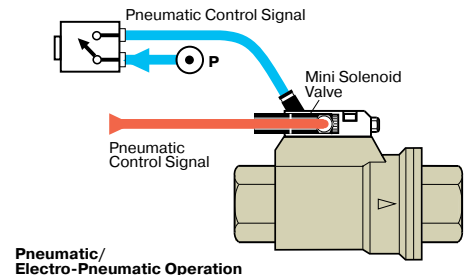

**WARNING** These products can expose you to chemicals including NICKEL or LEAD, which are known to the state of California to cause cancer, and LEAD which is known to cause birth defects or other reproductive harm. For more information go to [www.P65Warnings.ca.gov](http://www.P65Warnings.ca.gov).



- A
- B
- C
- D
- E
- F
- G
- H
- I
- J
- K
- L
- M
- N
- O

### 4203 Normally Closed, Double Female – NPT

PART NO.	C NPT	DN	F MM	G IN	H IN	H1 IN	L IN	LB.
4203 10 18 20	3/8	10	22	1.81	2.12	1.21	3.60	1.79
4203 15 22 20	1/2	15	27	2.03	2.33	1.31	4.13	2.39
4203 20 28 20	3/4	20	33	2.50	2.76	1.51	4.92	3.60
4203 40 50 20	1 1/2	40	60	3.78	4.01	2.12	6.67	9.22
4203 50 44 20	2	50	75	4.29	4.50	2.35	7.39	14.02

Pilot port: 1/8" - 27 NPT Complete with 1/8 NPT silencer

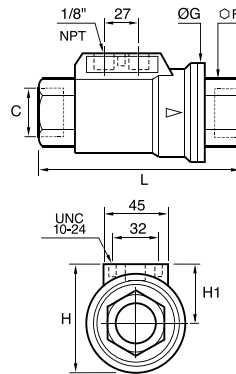

### 4202 Normally Closed, Double Female – BSPP

PART NO.	C BSPP	DN	F MM	G IN	H IN	H1 IN	L IN	KG.
4202 10 17 20	G3/8	10	22	46	54	31	98	.814
4202 15 21 20	G1/2	15	27	52	60	35	112	1.085
4202 20 27 20	G3/4	20	33	64	70	38	135	1.634
4202 25 34 20	G1	25	41	69	76	41.5	143	2.024
4202 32 42 20	G1 1/4	32	50	86	91	48	165	3.301
4202 40 49 20	G1 1/2	40	60	96	102	54	180	4.180
4202 50 48 20	G2	50	75	109	115	60.5	207	6.360

Pilot port: 1/8 BSPP Complete with 1/8 BSPT silencer

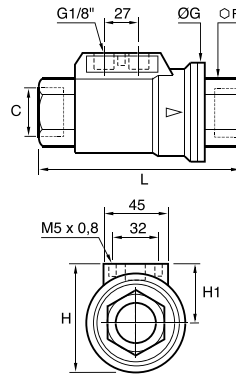

**WARNING** These products can expose you to chemicals including NICKEL or LEAD, which are known to the state of California to cause cancer, and LEAD which is known to cause birth defects or other reproductive harm. For more information go to [www.P65Warnings.ca.gov](http://www.P65Warnings.ca.gov).



## Replacement Handles

	VALVE	PLATED STEEL LEVER W/COVER	S.S. LEVER (NO COVER)	S.S. LEVER W/COVER	TEE (NO COVER)	OVAL (W/COVER)	SHORT LEVER (NO COVER)	PLATED STEEL LKG. LEVER W/COVER	S.S. LOCKING LEVER W/COVER
V500P (501, 502, 506, 510, 590, 591)	-4	2560-10082	2566-00105		2566-00147	2566-00215	2566-00231	2560-10080	2560-10081
	-6	2560-10082	2566-00105		2566-00147	2566-00215	2566-00231	2560-10080	2560-10081
	-8	2560-10082	2566-00105		2566-00147	2566-00215	2566-00231	2560-10080	2560-10081
	-10	2560-10097	2566-00178		2566-00179			2560-10100	
	-12	2560-10097	2566-00178		2566-00179	2566-00180	—	2560-10100	2560-10101
	-16	2560-10097	2566-00178		2566-00179	2566-00180	—	2560-10100	2560-10101
	-20	2566-00143	2566-00153			—	2566-00142	2566-00135	—
	-24	2566-00143	2566-00153			—	2566-00142	2566-00135	—
	-32	2566-00143	2566-00153			—	2566-00142	2566-00135	—
V501SS & V502SS	-4	—		2566-00132	—	2566-00108	2566-00146	—	2566-00138
	-6	—		2566-00132	—	2566-00108	2566-00146	—	2566-00138
	-8	—		2566-00132	—	2566-00108	2566-00146	—	2566-00138
	-12	—		2566-00133	—	2566-00109	—	—	2566-00184
	-16	—		2566-00133	—	2566-00109	—	—	2566-00184
V502SS	-20	—		2566-00134	—		—	—	2566-00185
	-24	—		2566-00134	—		—	—	2566-00185
	-32	—		2566-00134	—		—	—	2566-00185
V500CS & V502CS	-4	2566-00158			2566-00170	2566-00166		2566-00162	
	-6	2566-00158			2566-00170	2566-00166		2566-00162	
	-8	2566-00158			2566-00171	2566-00166		2566-00162	
	-12	2566-00159			2566-00172	2566-00167		2566-00163	
	-16	2566-00159			2566-00172	2566-00167		2566-00163	
	-20	2566-00160				2566-00168		2566-00164	
	-24	2566-00160				2566-00168		2566-00164	
	-32	2566-00161				2566-00169		2566-00165	
V506CS	-4	2566-00158			2566-00170	2566-00166		2566-00162	
	-6	2566-00158			2566-00170	2566-00166		2566-00162	
	-8							2566-00234	
	-12	—						2566-00235	
	-16	—						2566-00236	
V533P	-4	2560-10152	2566-00105		2566-00147	2566-00215	2566-00231	2560-10160	
	-6	2560-10152	2566-00105		2566-00147	2566-00215	2566-00231	2560-10160	
	-8	2560-10152	2566-00105		2566-00147	2566-00215	2566-00231	2560-10160	
	-12	2560-10153	2566-00178		2566-00179	2566-00180		2560-10168	
	-16	2560-10153	2566-00178		2566-00179	2566-00180		2560-10168	
V520P	-4				2566-00277			2566-00262	
	-6				2566-00277			2566-00262	
	-8				2566-00277			2566-00262	
	-12				2566-00280			2566-00261	
	-16				2566-00280			2566-00261	
	-20	2566-00143	2566-00153					2566-00135	
	-24	2566-00143	2566-00153					2566-00135	
	-32	2566-00143	2566-00153					2566-00135	
	40	2566-00253							
48	2566-00253								
V500HP, V506HP, V507HP	-4							BVHPLK-1 <sup>A</sup>	
	-6							BVHPLK-1 <sup>A</sup>	
	-8							BVHPLK-1 <sup>A</sup>	
	-12							BVHPLK-2 <sup>A</sup>	
	-16							BVHPLK-2 <sup>A</sup>	
	-20							BVHPLK-3 <sup>A</sup>	
	-24							BVHPLK-3 <sup>A</sup>	
-32							BVHPLK-3 <sup>A</sup>		

<sup>A</sup> Locking kit for use with standard handles



### Replacement Handle Nuts

VALVE	PLATED STEEL	STAINLESS STEEL
V500P-4	2567-00020	2567-00023
V500P-6	2567-00020	2567-00023
V500P-8	2567-00020	2567-00023
V500P-12	2567-00055	2567-00057
V500P-16	2567-00055	2567-00057
V500P-20	2567-00051	2567-00052
V500P-24	2567-00051	2567-00052
V500P-32	2567-00051	2567-00052
V500CS-4	2567-00020	2567-00023
V500CS-6	2567-00020	2567-00023
V500CS-8	2564-00020	2567-00023

### Replacement Handle Covers

VALVE	LEVER	SHORT LEVER	TEE
V500P-4	2569-00108	2569-00342	2569-00155
V500P-6	2569-00108	2569-00342	2569-00155
V500P-8	2569-00108	2569-00342	2569-00155
V500P-12	2569-00296		2569-00155
V500P-16	2569-00296		2569-00155
V500P-20	2569-00229	2569-00234	
V500P-24	2569-00229	2569-00234	
V500P-32	2569-00229	2569-00234	
V502SS-4		2569-00203	
V502SS-6		2569-00203	
V502SS-8		2569-00203	

- A
- B
- C
- D
- E
- F
- G
- H
- I
- J
- K
- L
- M
- N
- O

<b>STX</b>	Stem Extension Kit
<b>P</b>	For use on Brass Ball Valves
<b>1</b>	1: 1/4" thru 1/2" valves 2: 3/4" thru 1" valves
<b>125</b>	125: 1-1/4" extension length 225: 2-1/4" extension length

Note: Stem extensions cannot be used with series 509 and series 520.

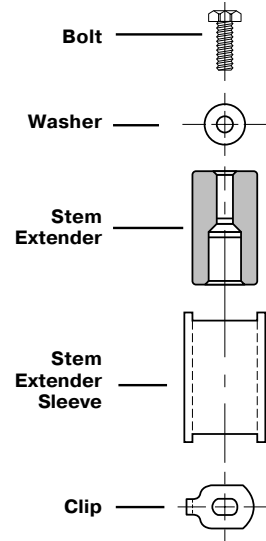

### Brass Valve Extension Dimensions STX-P-1-125

PART NO.	VALVE SIZE	B HEX	C HEX	H	L	M	N	D FLOW Ø
STX-P-1-125	1/4	15/16	15/16	3.96	4.96	2.03	3.73	.375
STX-P-1-125	3/8	15/16	15/16	3.96	4.96	2.03	3.73	.375
STX-P-1-125	1/2	1-1/16	1-1/16	3.96	5.05	2.20	3.84	.500
STX-P-2-125	3/4	1-1/4	1-5/16	3.96	5.25	2.42	4.06	.685
STX-P-2-125	1	1-1/2	1-9/16	3.96	5.89	2.75	4.33	.875

Note: Drawing shows STX-P assembled to XV500P series-not included

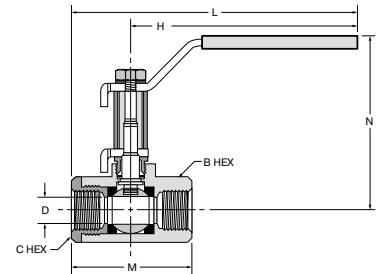

### Brass Valve Extension Dimensions STX-P-1-225

PART NO.	VALVE SIZE	B HEX	C HEX	H	L	M	N	D FLOW Ø
STX-P-1-225	1/4	15/16	15/16	3.96	4.96	2.03	4.73	.375
STX-P-1-225	3/8	15/16	15/16	3.96	4.96	2.03	4.73	.375
STX-P-1-225	1/2	1-1/16	1-1/16	3.96	5.05	2.20	4.84	.500
STX-P-2-225	3/4	1-1/4	1-5/16	3.96	5.25	2.42	5.06	.685
STX-P-2-225	1	1-1/2	1-9/16	3.96	5.89	2.75	5.33	.875

Note: Drawing shows STX-P assembled to XV500P series-not included

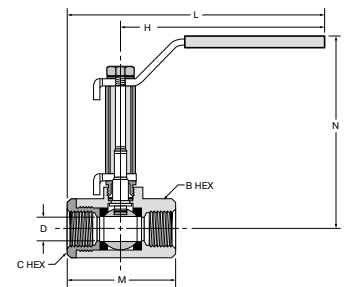

**WARNING** These products can expose you to chemicals including NICKEL or LEAD, which are known to the state of California to cause cancer, and LEAD which is known to cause birth defects or other reproductive harm. For more information go to [www.P65Warnings.ca.gov](http://www.P65Warnings.ca.gov).



A

B

C

D

E

F

G

H

I

J

K

L

M

N

O

# Needle Valves



Parker's all brass needle valves have metal-to-metal seats with fine thread screwdown. The specially formulated low temperature seal remains elastic to temperatures as low as  $-40^{\circ}\text{F}$  ( $-40^{\circ}\text{C}$ ).

## Product Features:

- Extruded Brass Body & Stem
- Low Temperature Seal
- Metal-to-Metal Seal
- Pin Handle

## Specifications:

### Pressure Range:

- Up to 150 PSI (10.3 bar)

### Temperature Range

- $-40^{\circ}$  to  $+175^{\circ}\text{F}$  ( $-40^{\circ}$  to  $+79.4^{\circ}\text{C}$ )
- Humidifier Valve Kit & Self Piercing Humidifier Kit:  
 $-30^{\circ}$  to  $+250^{\circ}\text{F}$  ( $-34.4^{\circ}$  to  $+121.1^{\circ}\text{C}$ )
- NV311P/NV312P:  $0^{\circ}$  to  $+150^{\circ}\text{F}$  ( $-17.7^{\circ}$  to  $+65.5^{\circ}\text{C}$ )

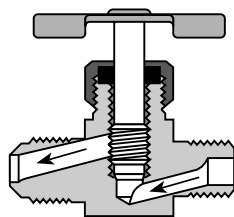
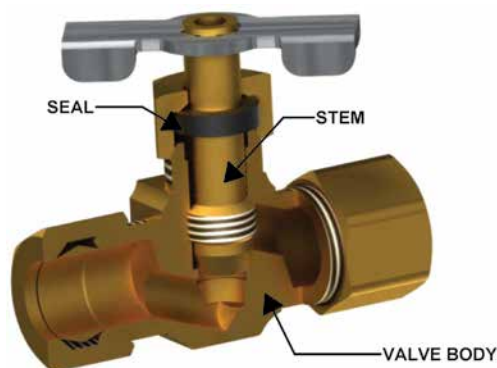

## Needle Valves Installation Instructions

Series NV valves should always be installed with the pressure against the seat. Refer to drawing to determine correct direction of flow.

**WARNING** These products can expose you to chemicals including NICKEL or LEAD, which are known to the state of California to cause cancer, and LEAD which is known to cause birth defects or other reproductive harm. For more information go to [www.P65Warnings.ca.gov](http://www.P65Warnings.ca.gov).



Click here for CADs, Product Specifications or to Configure Parts Online

### Angle Needle Valve NV101F

Flare to Male Pipe \* Provided with Pin Handle  
 Temperature Range: -45° to +250° F (-42.7° to +121.1° C)

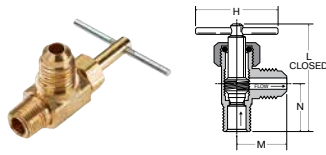

PART NO.	TUBE SIZE	PIPE THREAD	H	L	M	N
NV101F-4-2*	1/4	1/8	1.50	1.58	.75	.66
NV101F-6-4	3/8	1/4	1.38	1.86	.95	.90

### Needle Valve NV102F

Flare to Flare \*Provided with Pin Handle  
 Temperature Range: -45° to +250° F (-42.7° to +121.1° C)

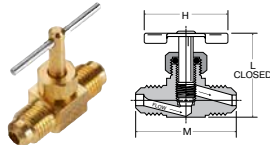

PART NO.	TUBE SIZE	H	L	M
NV102F-4*	1/4	1.50	1.34	1.50

### Needle Valve NV103F

Flare to Male Pipe \*Provided with Pin Handle  
 Temperature Range: -45° to +250° F (-42.7° to +121.1° C)

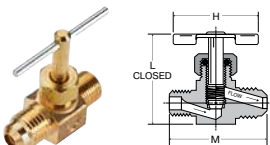

PART NO.	TUBE SIZE	PIPE THREAD	H	L	M
NV103F-4-2*	1/4	1/8	1.50	1.33	1.35

### Humidifier Valve HV104C

Temperature Range: -45° to +250° F (-42.7° to +121.1° C)

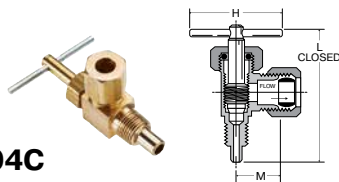

PART NO.	TUBE SIZE	PIPE THREAD	H	L	M
HV104C-4-2	1/4	1/8	1.50	1.89	.53

### Humidifier Valve Clamp Kit HV104C-KIT

Temperature Range: -30° to +250° F (-34.4° to +121.1° C) Clamp fits 3/8" O.D. through 1.315" O.D. tube or pipe. Kit includes 60PT-4 and 63PT-4 for assembly with plastic or nylon tubing. For complete kit, specify entire part number as shown below:

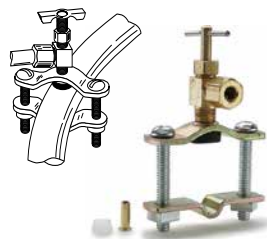

PART NO.	TUBE SIZE	PIPE THREAD
HV104C-4-2 KIT	1/4	1/8

### Self-Piercing Humidifier Valve Clamp Kit SPV104C-KIT

Temperature Range: -30° to +250° F (-34.4° to +121.1° C) Clamp fits 3/8" O.D. through 1.315" O.D. tube or pipe. Kit includes 60PT-4 and 63PT-4 for assembly with plastic or nylon tubing. For complete kit, specify entire part number as shown below:

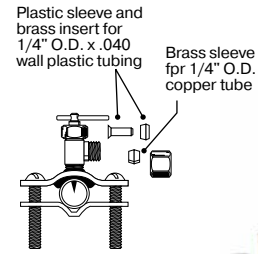

PART NO.	TUBE SIZE	PIPE THREAD
SPV104C KIT	1/4	1/8

### Angle Needle Valve NV104C-NV104CA

Compression to Male Pipe \*Provided with Pin Handle  
 Temperature Range: -45° to +250° F (-42.7° to +121.1° C)

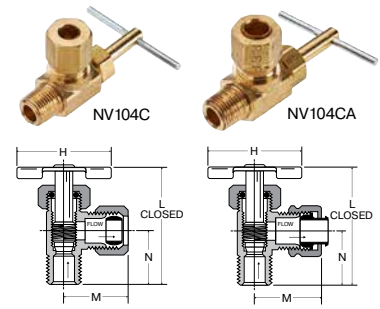

PART NO.	TUBE SIZE	PIPE THREAD	H	L	M	N
NV104C-4-2*	1/4	1/8	1.50	1.54	.88	.67
NV104CA-4-2*	1/4	1/8	1.50	1.49	.77	.66
NV104C-4-4	1/4	1/4	1.38	1.80	.93	.75
NV104C-5-2*	5/16	1/8	1.50	1.63	.88	.68
NV104C-6-4	3/8	1/4	1.38	1.76	.94	.81

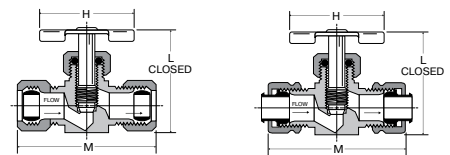

### Needle Valve NV105C-NV105CA

Compression to Compression  
 \*Provided with Pin Handle  
 Temperature Range: -45° to +250° F (-42.7° to +121.1° C)

PART NO.	TUBE SIZE	H	L	M
NV105C-4*	1/4	1.50	1.41	1.75
NV105C-5*	5/16	1.50	1.35	1.73
NV105C-6	3/8	1.38	1.55	1.93
NV105CA-4*	1/4	1.50	1.41	1.64
NV105CA-6	3/8	1.38	1.55	1.78

**WARNING** These products can expose you to chemicals including NICKEL or LEAD, which are known to the state of California to cause cancer, and LEAD which is known to cause birth defects or other reproductive harm. For more information go to [www.P65Warnings.ca.gov](http://www.P65Warnings.ca.gov).

- A
- B
- C
- D
- E
- F
- G
- H
- I
- J
- K
- L
- M
- N
- O

Click here for CADs, Product Specifications or to Configure Parts Online

A  
B  
C  
D  
E  
F  
G  
H  
I  
J  
K  
L  
M  
N  
O

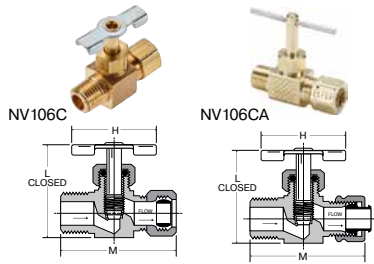

### Needle Valve NV106C-NV106CA

Compression to Male Pipe  
\*Provided with Pin Handle

Temperature Range: -45° to +250° F (-42.7° to +121.1° C)

PART NO.	TUBE SIZE	PIPE THREAD	H	L	M
NV106C-4-2*	1/4	1/8	1.50	1.41	1.53
NV106C-4-4*	1/4	1/4	1.50	1.40	1.55
NV106C-5-2*	5/16	1/8	1.50	1.35	1.50
NV106C-6-4	3/8	1/4	1.38	1.56	1.75
NV106CA-4-2	1/4	1/8	1.50	1.41	1.47
NV106CA-4-4*	1/4	1/4	1.50	1.33	1.52
NV106CA-6-4	3/8	1/4	1.38	1.53	1.78

### Needle Valve NV311P

Poly-Tite to Male Pipe

Temperature Range: 0° to +150° F (0° to +65.5° C)

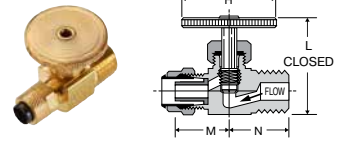

PART NO.	TUBE SIZE	PIPE THREAD	H	L	M	N
NV311P-4-2	1/4	1/8	1.07	1.17	.50	.63
NV311P-4-4	1/4	1/4	1.07	1.18	.50	.72
NV311P-6-4	3/8	1/4	1.07	1.19	.56	.72

### Angle Needle Valve NV312P

Poly-Tite to Male Pipe

Temperature Range: 0° to +150° F (0° to +65.5° C)

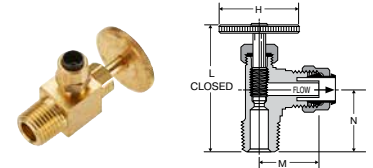

PART NO.	TUBE SIZE	PIPE THREAD	H	L	M	N
NV312P-4-2	1/4	1/8	1.07	1.53	.48	.68
NV312P-4-4	1/4	1/4	1.07	1.72	.56	.86
NV312P-6-4	3/8	1/4	1.07	1.68	.64	.86

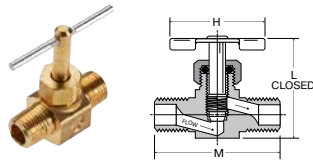

### Needle Valve NV107P

Male Pipe to Male Pipe

\*Provided with Pin Handle

Temperature Range: -45° to +250° F (-42.7° to +121.1° C)

PART NO.	PIPE THREAD	H	L	M
NV107P-2*	1/8	1.50	1.35	1.25
NV107P-4	1/4	1.38	1.54	1.65

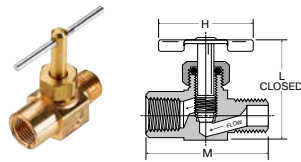

### Needle Valve NV108P

Female Pipe to Male Pipe

\*Provided with Pin Handle

Temperature Range: -45° to +250° F (-42.7° to +121.1° C)

PART NO.	PIPE THREAD	H	L	M
NV108P-2*	1/8	1.50	1.36	1.24
NV108P-4	1/4	1.38	1.56	1.61

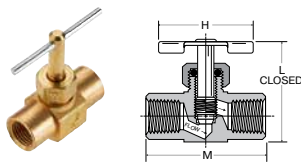

### Needle Valve NV109P

Female Pipe to Female Pipe

\*Provided with Pin Handle

Temperature Range: -45° to +250° F (-42.7° to +121.1° C)

PART NO.	PIPE THREAD	H	L	M
NV109P-2*	1/8	1.50	1.35	1.25
NV109P-4	1/4	1.38	1.53	1.60

**WARNING** These products can expose you to chemicals including NICKEL or LEAD, which are known to the state of California to cause cancer, and LEAD which is known to cause birth defects or other reproductive harm. For more information go to [www.P65Warnings.ca.gov](http://www.P65Warnings.ca.gov).



# Drain Cocks/ Ground Plug Shutoff



Parker's ground plug shutoffs are manufactured from castings or forged bodies for extra strength. Hand tightening provides a metal-to-metal seal. Drain cocks are manufactured in both external and internal seats.

## Specifications:

### Pressure Range:

- Ground Plug Shutoff: 30 PSI (2.0 bar)
- Drain Cocks: Up to 150 PSI (10.3 bar)

### Temperature Range

- Ground Plug Shutoff: 32° to +125° F (0° to +51.6° C)
- V406P/V407P: -40° to +180° F (-40° to +82.2° C)
- Drain Cocks: -65° to +250° F (-53.8° to +121.1° C)
- DCR601: -30° to +250° F (-34.4° to +121.1° C)



**WARNING** These products can expose you to chemicals including NICKEL or LEAD, which are known to the state of California to cause cancer, and LEAD which is known to cause birth defects or other reproductive harm. For more information go to [www.P65Warnings.ca.gov](http://www.P65Warnings.ca.gov).



A

B

C

D

E

F

G

H

I

J

K

L

M

N

O

[Click here for CADs, Product Specifications or to Configure Parts Online](#)

A  
B  
C  
D  
E  
F  
G  
H  
I  
J  
K  
L  
M  
N  
O

### Ground Plug Shutoff V203F

Flare to Flare  
Temperature Range: +32° to +125° F (0° to +51.6° C)

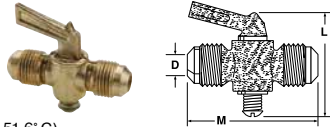

PART NO.	TUBE SIZE	L	M	FLOW DIA. D
V203F-6-6	3/8	2.26	2.13	.220
V203F-8-8	1/2	2.26	2.50	.281

### Ground Plug Shutoff V204F

Flare to Male Pipe  
Temperature Range: +32° to +125° F (0° to +51.6° C)

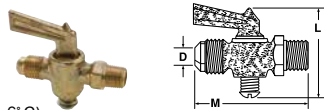

PART NO.	TUBE SIZE	PIPE THREAD	L	M	FLOW DIA. D
V204F-4-2	1/4	1/8	1.85	2.00	.188
V204F-6-4	3/8	1/4	1.85	2.18	.218

### Ground Plug Shutoff V303C / V303CA

Compression to Compression  
Temperature Range: +32° to +125° F (0° to +51.6° C)

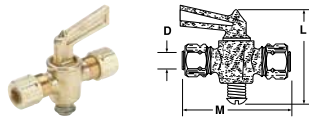

PART NO.	TUBE SIZE	L	M	FLOW DIA. D
V303C-4-4	1/4	1.88	2.33	.188
V303CA-4-4	1/4	1.90	1.75	.188
V303C-6-6	3/8	2.26	2.45	.218
V303CA-6-6	3/8	1.76	1.60	.218

### Ground Plug Shutoff V304C / V304CA

Compression to Male Pipe  
Temperature Range: +32° to +125° F (0° to +51.6° C)

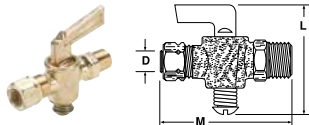

PART NO.	TUBE SIZE	PIPE THREAD	L	M	FLOW DIA. D
V304C-4-2	1/4	1/8	1.90	2.29	.188
V304CA-4-2	1/4	1/8	1.88	2.00	.188
V304C-4-4	1/4	1/4	1.90	2.15	.188
V304C-6-4	3/8	1/4	1.83	2.24	.218
V304CA-6-4	3/8	1/4	1.83	2.11	.218

### Ground Plug Shutoff V401P

Male Pipe to Male Pipe  
Temperature Range: +32° to +125° F (0° to +51.6° C)

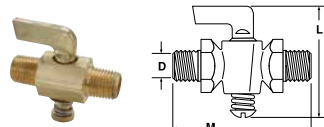

PART NO.	PIPE THREAD	L	M	FLOW DIA. D
V401P-2-2	1/8	1.90	2.25	.188
V401P-4-4	1/4	1.90	1.98	.188

### Ground Plug Shutoff V402P

Female Pipe to Male Pipe  
Temperature Range: +32° to +125° F (0° to +51.6° C)

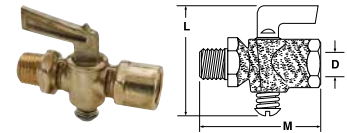

PART NO.	FEMALE PIPE THREAD	PIPE THREAD	L	M	FLOW DIA. D
V402P-2-2	1/8	1/8	1.85	1.78	.218
V402P-4-4	1/4	1/4	1.86	2.26	.218
V402P-6-6	3/8	3/8	2.34	2.21	.245

### Ground Plug Shutoff V403P

Female Pipe to Female Pipe  
Temperature Range: +32° to +125° F (0° to +51.6° C)

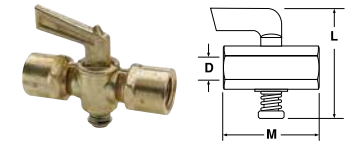

PART NO.	FEMALE PIPE THREAD	L	M	FLOW DIA. D
V403P-2-2	1/8	1.90	1.51	.218
V403P-4-4	1/4	1.90	1.65	.188
V403P-6-6*	3/8	2.25	2.00	.250

\*Made from extruded bar stock

### Three-Way Valve V406P

Female Pipe three ends  
Temperature Range: -40° to +180° F ( -40° to +82.2° C)

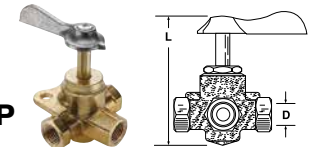

PART NO.	PIPE THREAD	L	FLOW DIA. D
V406P-4	1/4	3.10	.281

### Four-Way Valve V407P

Female Pipe four ends  
Temperature Range: -40° to +180° F ( -40° to +82.2° C)

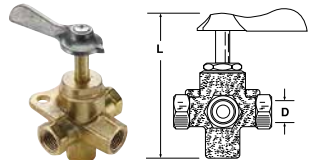

PART NO.	PIPE THREAD	L	FLOW DIA. D
V407P-4	1/4	3.30	.281

### Ground Plug Shutoff DC601

Temperature Range: +32° to +125° F (0° to +51.6° C)

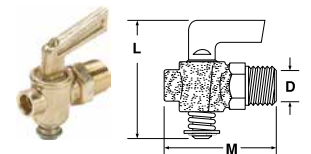

PART NO.	PIPE THREAD	L	M	FLOW DIA. D
DC601-2	1/8	1.90	1.40	.170
DC601-4	1/4	1.90	1.52	.170
DC601-6	3/8	2.26	1.74	.281
DC601-8	1/2	2.29	1.82	.281

**WARNING** These products can expose you to chemicals including NICKEL or LEAD, which are known to the state of California to cause cancer, and LEAD which is known to cause birth defects or other reproductive harm. For more information go to [www.P65Warnings.ca.gov](http://www.P65Warnings.ca.gov).

[Click here for CADs, Product Specifications or to Configure Parts Online](#)

### Drain Cock DCR601

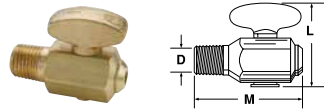

Temperature Range: -30° to +250° F (-34.4° to +121.1° C)

PART NO.	PIPE THREAD	L	M	FLOW DIA. D
DCR601-4	1/4	1.41	1.73	.156

### Bib Drain Valve DC607

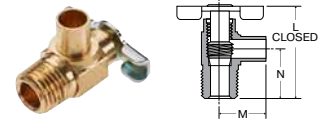

Temperature Range: -65° to +250° F (-53.8° to +121.1° C)

PART NO.	HOSE SIZE	PIPE THREAD	FLOW	L	M	N
DC607-4	3/8	1/4	.28	1.32	.67	.71

### Internal Seal Drain Cock DC602

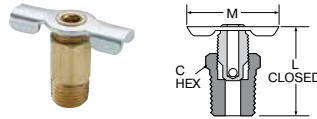

Temperature Range: -65° to +250° F (-53.8° to +121.1° C)

PART NO.	PIPE THREAD	C HEX	L	M
DC602-2	1/8	13/32	.92	1.25
DC602-4	1/4	9/16	.94	1.25

### Drain Cock DC603

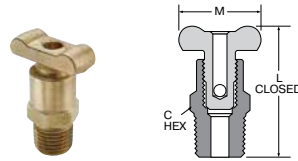

Temperature Range: -65° to +250° F (-53.8° to +121.1° C)

PART NO.	PIPE THREAD	C HEX	L	M
DC603-2	1/8	5/8	1.41	1.00
DC603-4	1/4	5/8	1.54	1.16
DC603-6	3/8	11/16	1.63	1.16

### External Seal Drain Cock DC604

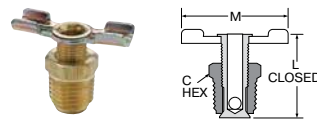

Temperature Range: -65° to +250° F (-53.8° to +121.1° C)

PART NO.	PIPE THREAD	C HEX	L	M
DC604-2*	1/8	7/16	.85	1.25
DC604-4	1/4	9/16	1.00	1.38
DC604-6*	3/8	11/16	1.22	1.68

\*When assembled handle wings are down facing

### External Seal Drain Cock DC606

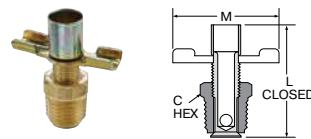

Temperature Range: -65° to +250° F (-53.8° to +121.1° C)

PART NO.	PIPE THREAD	C HEX	L	M
DC606-4	1/4-18	9/16	1.50	1.38

**WARNING** These products can expose you to chemicals including NICKEL or LEAD, which are known to the state of California to cause cancer, and LEAD which is known to cause birth defects or other reproductive harm. For more information go to [www.P65Warnings.ca.gov](http://www.P65Warnings.ca.gov).



- A
- B
- C
- D
- E
- F
- G
- H
- I
- J
- K
- L
- M
- N
- O



# Accessories

Blow Guns

Silencers

Bins & Copper Tubing



For Bins information visit:  
[www.parker.com/bins](http://www.parker.com/bins)



**Blow Guns**

**410-S**

Controlled Pressure  
p. L6



**410-SV**

Controlled Pressure  
p. L6



**415-S**

Controlled Pressure  
p. L6



**400-S-TIP**

Replacement Tip  
p. L6



**410**

Full Pressure  
p. L6



**410-N**

Full Pressure  
p. L6



**415-N**

Full Pressure  
p. L6



**BG441-NBL**

BG Series  
p. L7



**BG442-SBL**

BG Series  
p. L7



**BG443-NBL**

BG Series  
p. L7



**BG444-SBL**

BG Series  
p. L7



**Silencers**

**0673 0610 0670**

Threaded Silencer  
UNF, NPT or BSPP  
p. L11



**0671**

Plug-In Silencer  
p. L11



**0673**

Compact Threaded  
Silencer Male  
BSPP, M5  
p. L11



**0677**

Miniature Silencer  
BSPP  
p. L11



**0614 0672**

Flow Control  
Silencer Male NPT,  
BSPP  
p. L12



**0611 0674**

Threaded Silencer  
NPT, BSPP, M5  
p. L12



**0676**

Flow Control  
Silencer BSPP  
p. L12



**0682**

Stainless Steel  
Threaded Silencer  
Male BSPP  
p. L12



**0683**

Stainless Steel  
Threaded Silencer  
Male NPT  
p. L12



**Bins**

**16-CB**

16 Compartment  
p. L13



**24-CB**

24 Compartment  
p. L13



**ADJ-CB**

Adjustable  
Compartments  
p. L13



**4CB-SR**

Slide Rack  
p. L13



**LSR-STAND**

Stand  
p. L14



**9-DC**

9 Drawer  
p. L14



**18-DC**

18 Drawer  
p. L14



**24B-CABINET**

24 Opening  
p. L14



**40B-CABINET**

40 Opening  
p. L15



**40B-STAND**

Stand  
p. L15

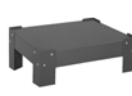

**PNEU-CAB**

Mobile Cabinet  
p. L15



**Copper Tubing**

**X50CT**

Coiled Copper Tubing  
p. L15



**WARNING** These products can expose you to chemicals including NICKEL or LEAD, which are known to the state of California to cause cancer, and LEAD which is known to cause birth defects or other reproductive harm. For more information go to [www.P65Warnings.ca.gov](http://www.P65Warnings.ca.gov).

[Click here for CADs, Product Specifications or to Configure Parts Online](#)

# Blow Guns

## Controlled Pressure Blow Guns

Parker Controlled Pressure Blow Guns meet OSHA requirements (section 29 CFR 1910.242 paragraph b), and directive #100-1. "Compressed air shall not be used for cleaning purposes except where reduced to less than 30 psi, and then only with effective chip guarding and personal protective equipment."

Parker Controlled Pressure Blow Guns have a black epoxy coated zinc body and vented nozzles to prevent pressure build-up when dead ending occurs up to 150 PSI (10.3 bar).

SPECIFICATIONS		
PART NO.	MAXIMUM PRESSURE PSI (BAR)	WT. (LB) P/PIECE
410-S	150 (10.3)	.50
410-SV	150 (10.3)	.53
415-S	150 (10.3)	.48



**410-S**  
Parker Controlled Pressure Blow Guns features thumb lever valve actuator and brass nozzle. Inlet port is 1/4" NPT.



**410-SV**  
Parker Venturi Nozzle Controlled Pressure Blow Gun with thumb lever valve and large venturi side ports for high volume flow. Inlet port is 1/4" NPT.



**415-S**  
Parker Controlled Pressure Blow Guns features push button valve actuator and brass nozzle. Inlet port is 1/4" NPT.



**400-S-TIP**  
Blow Gun Replacement Tip

## Full Pressure Blow Guns

The following Parker Blow Guns must have a pressure regulator setting below 30 psi to conform to OSHA safety requirements 29 CFR 1910.242 Paragraph b.

SPECIFICATIONS		
PART NO.	MAXIMUM PRESSURE PSI (BAR)	WT. (LB) P/PIECE
410	150 (10.3)	.48
410-N	150 (10.3)	.51
415-N	150 (10.3)	.49



**410**  
Parker two way thumb lever valve has a zinc body with 1/4" NPT inlet and 1/8" NPSF outlet.

Note: Standard Gun without nozzle.



**410-N**  
Parker thumb lever style Blow Gun features a zinc body, brass nozzle, and 1/4" NPT female inlet.



**415-N**  
Parker Blow Gun features a push button style actuator, zinc body with a brass nozzle and 1/4" NPT female inlet.

**WARNING** These products can expose you to chemicals including NICKEL or LEAD, which are known to the state of California to cause cancer, and LEAD which is known to cause birth defects or other reproductive harm. For more information go to [www.P65Warnings.ca.gov](http://www.P65Warnings.ca.gov).



- A
- B
- C
- D
- E
- F
- G
- H
- I
- J
- K
- L
- M
- N
- O

Click here for CADs, Product Specifications or to Configure Parts Online

- A
- B
- C
- D
- E
- F
- G
- H
- I
- J
- K
- L
- M
- N
- O

**BG Series Blow Guns**

Made from impact resistant plastic, BG Series blow guns are durable and versatile. Extended nozzles allow air to be directed where it is required. The pistol grip trigger allows greater control over the amount of air delivered. Combined, these two features provide superior performance in a light weight, ergonomically designed package.

Nozzles are available in short and extended versions and most models meet OSHA directives on the use of compressed air for cleaning purposes. OSHA directive #100-1 states that “when dead ending occurs a static pressure at the main orifice shall not exceed 30 psi.” For those blow guns that do not meet this requirement, OSHA requires that “compressed air shall not be used for cleaning purposes except where reduced to less than 30 psi, and then only with effective chip guarding

and personal protective equipment” (section 29 CFR 1910.242 paragraph b). Please refer to the blow gun descriptions below for compatibility with OSHA directive #100-1.

Nozzle configurations are designed for maximum flexibility. Applications with special requirements may find the BG443-NBL with a 1/8” NPT fitting convenient for adapting existing nozzles or extra-long extensions. For information on specials or made-to-order blow gun nozzles, please contact the Fluid System Connectors Division.

- Easy to control variable flow pistol grip trigger.
- Nozzles available that meet OSHA requirements.
- Lightweight ergonomical design.
- Bodies are constructed of impact resistant plastic.

SPECIFICATIONS	
RATED PRESSURE PSI	175 (12.0 bar)
TEMPERATURE RANGE	TO +120° F (+48.8° C)
INLET PORT	1/4” NPTF

NOMENCLATURE	
EXAMPLE: BG442-SBL	ATTRIBUTE:
BG	BG SERIES BLOW GUN
4	INLET PORT IN 16THS
42	NOZZLE STYLE 41 - EXTENDED 42 - EXTENDED (OSHA) 43 - 1/8” FNPT 44 - SHORT (OSHA)
S	MEETS OSHA REQUIREMENTS S - YES N - NO
BL	COLOR BL - BLACK

**BG441-NBL BG Series Blow Gun**

PART NO.	NOZZLE	MEETS OSHA REQUIREMENTS
BG441-NBL	EXTENDED	NO



**BG443-NBL BG Series Blow Gun**

PART NO.	NOZZLE	MEETS OSHA REQUIREMENTS
BG443-NBL	1/8” FEMALE NPT	NO



**BG442-SBL BG Series Blow Gun**

PART NO.	NOZZLE	MEETS OSHA REQUIREMENTS
BG442-SBL	EXTENDED	YES



**BG444-SBL BG Series Blow Gun**

PART NO.	NOZZLE	MEETS OSHA REQUIREMENTS
BG444-SBL	VORTEC	YES



**WARNING** These products can expose you to chemicals including NICKEL or LEAD, which are known to the state of California to cause cancer, and LEAD which is known to cause birth defects or other reproductive harm. For more information go to [www.P65Warnings.ca.gov](http://www.P65Warnings.ca.gov).





Click here for CADs, Product Specifications or to Configure Parts Online

# Silencers

## Technical Specification of Silencers:

MATERIAL	WORKING PRESSURE	WORKING TEMPERATURE
SINTERED BRONZE	175 PSI (12.0 bar)	-4° to +300° F (-20° to +148.8° C)
POLYETHYLENE	145 PSI (9.9 bar)	-14° to +175° F (-25.5° to +79.4° C)
STAINLESS STEEL	175 PSI (12.0 bar)	-4° to +355° F (-20° to +179.4° C)

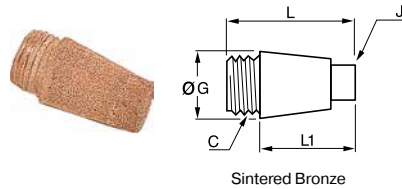

Sintered Bronze

## 0673 0610 0670 Threaded Silencer UNF, NPT or BSPP

PART NO.	C UNF/NPT	J IN	G IN	L IN	L1 IN	WT OZ
0673 00 20*	10-32	.27	.31	.34	.18	.07
0610 00 11	1/8	.31	.42	.89	.71	.21
0610 00 14	1/4	.39	.59	1.10	.87	.46
0610 00 18	3/8	.51	.75	1.42	1.14	.85
0610 00 22	1/2	.59	.91	1.73	1.42	1.48

PART NO.	C BSPP	J MM	G MM	L MM	L1 MM	WT KG
0670 00 10	G1/8	7	12	20.5	15	.007
0670 00 13	G1/4	8	15	24.5	18.5	.013
0670 00 17	G3/8	10	19	37	29	.033
0670 00 21	G1/2	14	23	40	31	.049
0670 00 27	G3/4	16.5	29.5	51	40.5	.092
0670 00 34	G1	20	36	60	49.5	.140

\* Brass Body

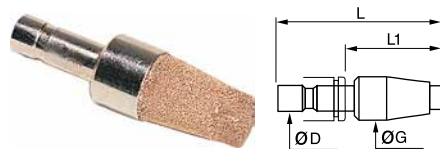

Body Nickel Plated  
Brass Sintered Bronze

## 0671 Plug-In Silencer

PART NO.	C	G MM	L MM	L1 MM	WT OZ
0671 04 00	4	13	41.5	24.5	.015
0671 06 00	6	15	48	29	.023
0671 08 00	8	15	49.5	29.5	.024
0671 10 00	10	19.5	68	43.5	.054
0671 12 00	12	20	68.5	43	.055

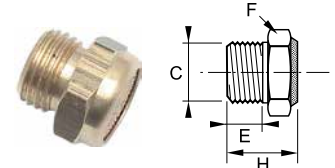

Body Nickel Plated Brass  
Sintered Bronze

## 0673 Compact Threaded Silencer Male BSPP, M5

PART NO.	C	E MM	F MM	H MM	WT OZ
0673 00 10	G1/8	4	13	12	.006
0673 00 13	G1/4	6	16	16	.012
0673 00 17	G3/8	8	19	17	.022
0673 00 19	M5X0.8	8	8	8.5	.001
0673 00 20	UNF 10-32	4	6	11	.006
0673 00 21	G1/2	9	24	18	.037

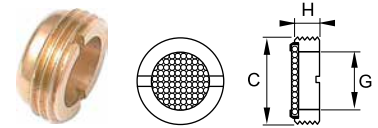

Body Nickel Plated Brass  
Sintered Bronze

## 0677 Miniature Silencer BSPP

PART NO.	C	G MM	H MM	WT OZ
0677 00 10	G1/8	5.5	4	.002
0677 00 13	G1/4	6	4.5	.003
0677 00 17	G3/8	9.5	5	.006
0677 00 21	G1/2	12.5	5.5	.012
0677 00 27	G3/4	19	6	.014
0677 00 34	G1	24	7	.025

**WARNING** These products can expose you to chemicals including NICKEL or LEAD, which are known to the state of California to cause cancer, and LEAD which is known to cause birth defects or other reproductive harm. For more information go to [www.P65Warnings.ca.gov](http://www.P65Warnings.ca.gov).



- A
- B
- C
- D
- E
- F
- G
- H
- I
- J
- K
- L
- M
- N
- O

[Click here for CADs, Product Specifications or to Configure Parts Online](#)

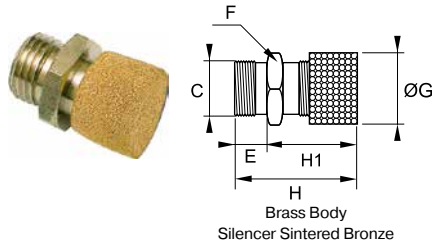

### 0614 0672 Flow Control Silencer Male NPT, BSPP

PART NO.	C NPT	E	F MM	G	H MIN	H MAX	H1	WT OZ
0614 00 22	1/2	.47	27	1.06	1.54	1.65	1.30	1.55

PART NO.	C BSPP	E MM	F MM	G MM	H MIN	H MAX	H1 MM	WT KG
0672 00 10	1/8	8	14	14	24	27	18	.012
0672 00 13	1/4	8	17	17	25	28	19	.023
0672 00 17	3/8	10	22	22	30	33	24	.033
0672 00 21	1/2	12	27	27	39	42	33	.044

Consult us for flow characteristics

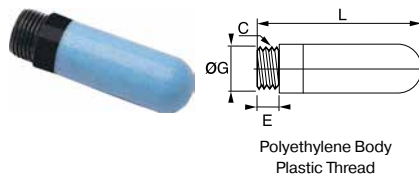

### 0611 0674 Threaded Silencer NPT, BSPP, M5

PART NO.	C NPT	E IN	G IN	L IN	WT OZ
0611 00 11	1/8	.24	.49	1.34	.07
0611 00 14	1/4	.28	.61	1.67	.11
0611 00 22	1/2	.43	.93	3.07	.35

PART NO.	C BSPP	E MM	G MM	L MM	WT OZ
0674 00 19	M5X0.8	4	6.5	23	.001
0674 00 10	G1/8	6	12.5	34	.002
0674 00 13	G1/4	7	15.5	42.5	.003
0674 00 17	G3/8	11.5	18.5	67.5	.006
0674 00 21	G1/2	11	23.5	78	.010
0674 00 27	G3/4	15.5	38.5	131	.040
0674 00 34	G1	19.5	49	160	.050

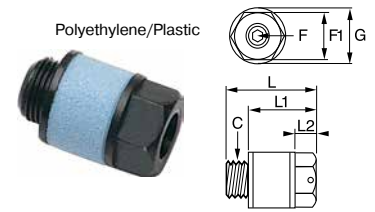

### 0676 Flow Control Silencer BSPP

PART NO.	C BSPP	F MM	F1 MM	G MM	L MM	L1 MM	L2 MM	WT OZ
0676 00 10	G1/8	2.5	13	15	20.5	14.5	5	.002
0676 00 13	G1/4	4	15	18	29	22	7	.007

NO. OF TURNS	FLOW SCFM AT 87 PSI									NOISE LEVEL dBA*	
	0	1	2	3	4	5	6	7	8		9
0676 00 10	0	1.06	3.2	7.4	11.8	13	13.8	13.8	13.9	13.9	82
0676 00 13	0	.78	.88	1.77	12	26.5	33	34.6	35.3	36	84

\* dBA at 87 PSI and 12 SCFM

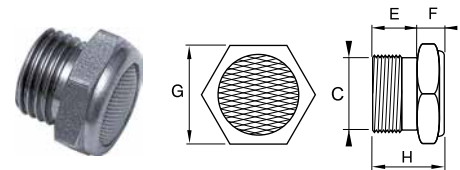

### 0682 Stainless Steel Threaded Silencer Male BSPP

PART NO.	C BSPP	E MM	F MM	G MM	H MM	WT KG
0682 00 10	G1/8	8	7	14	15	.009
0682 00 13	G1/4	8	7	17	15	.013
0682 00 17	G3/8	10	8	22	18	.020
0682 00 21	G1/2	12	10	27	22	.038
0682 00 27	G3/4	15	12	32	27	.066
0682 00 34	G1	18	14	38	32	.118

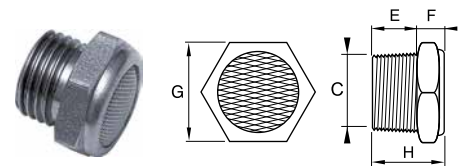

### 0683 Stainless Steel Threaded Silencer Male NPT

PART NO.	C NPT	E IN	F IN	G MM	H IN	WT KG
0683 00 11	1/8	.28	.28	14	.55	.35
0683 00 14	1/4	.43	.28	17	.71	.53
0683 00 18	3/8	.43	.31	22	.75	.81
0683 00 22	1/2	.59	.39	27	.98	1.55

**WARNING** These products can expose you to chemicals including NICKEL or LEAD, which are known to the state of California to cause cancer, and LEAD which is known to cause birth defects or other reproductive harm. For more information go to [www.P65Warnings.ca.gov](http://www.P65Warnings.ca.gov).

[Click here for CADs, Product Specifications or to Configure Parts Online](#)

# Bins, Bags & Copper Tubing

## 16 Compartment Large Scoop Box

- Prime cold rolled steel outer shell
- High impact styrene insert with 16 compartments
- Scooped bottom compartments for easy part removal
- Full piano hinge on cover provides rigidity
- Positive pull-down catch keeps cover tightly closed to prevent part migration
- Handle allows for easy transport
- Durable gray powder coat finish

PART NO.	DIMENSIONS (IN.)		
	WIDTH	DEPTH	HEIGHT
16-CB	18	12	3



## 24 Compartment Large Scoop Box

- Prime cold rolled steel outer shell
- High impact styrene insert with 24 compartments
- Scooped bottom compartments for easy part removal
- Full piano hinge on cover provides rigidity
- Positive pull-down catch keeps cover tightly closed to prevent part migration
- Handle allows for easy transport
- Durable gray powder coat finish

PART NO.	DIMENSIONS (IN.)		
	WIDTH	DEPTH	HEIGHT
24-CB	18	12	3



## ADJ-CB

- Prime cold rolled steel outer shell
- High impact styrene insert with 4 fixed vertical compartments and 9 moveable dividers adjustable on 1" centers
- Full piano hinge on cover provides rigidity
- Positive pull-down catch keeps cover tightly closed to prevent part migration
- Durable gray powder coat finish

PART NO.	DIMENSIONS (IN.)			COMPARTMENTS
	WIDTH	DEPTH	HEIGHT	
ADJ-CB	18	12	3	ADJUSTABLE



## Easy Glide Slide Rack (Holds 4 16-CB or 24-CB per rack)

- Sturdy construction using prime cold-rolled steel
- Each cradle holds up to 40 lbs
- Easy glide slides allow boxes to move in and out smoothly
- Center braces on cradles provide extra rigidity
- Reinforced rack keeps boxes level
- Boxes can be easily removed for transport to work areas
- Base and locking hinge are available as accessories
- Durable gray powder coat finish

PART NO.	DIMENSIONS (IN.)		
	WIDTH	DEPTH	HEIGHT
4CB-SR	20	15.75	15



**WARNING** These products can expose you to chemicals including NICKEL or LEAD, which are known to the state of California to cause cancer, and LEAD which is known to cause birth defects or other reproductive harm. For more information go to [www.P65Warnings.ca.gov](http://www.P65Warnings.ca.gov).



- A
- B
- C
- D
- E
- F
- G
- H
- I
- J
- K
- L
- M
- N
- O

Click here for CADs, Product Specifications or to Configure Parts Online

- A
- B
- C
- D
- E
- F
- G
- H
- I
- J
- K
- L
- M
- N
- O

### LSR-Stand

- Sturdy all steel construction
- Legs attach easily using fasteners provided
- Raises units 15 inches off the floor
- Durable gray powder finish

PART NO.	DIMENSIONS (IN.)		
	WIDTH	DEPTH	HEIGHT
LSR-STAND	20 5/8	16 1/4	15 5/8



### 9 Drawer Cabinet

- Prime cold rolled steel construction
- High density drawer cabinet, easy to store large quantities of small parts
- Drawers feature interlocking design for superior strength
- Drawers have full width handles and easy glide runners
- Each drawer includes 2 easy label dividers, which are adjustable on 1" centers
- Cabinets can be stacked using mounting holes
- Durable gray powder coat finish
- Ships fully assembled

PART NO.	DIMENSIONS (IN.)			DRAWER DIMENSIONS (IN.)		
	WIDTH	DEPTH	HEIGHT	WIDTH	DEPTH	HEIGHT
9-DC	17.25	11.625	10.875	5.375	11.25	2.75



### 18 Drawer Cabinet

- Prime cold rolled steel construction
- High density drawer cabinet, easy to store large quantities of small parts
- Drawers feature interlocking design for superior strength
- Drawers have full width handles and easy glide runners
- Each drawer includes 2 easy label dividers, which are adjustable on 1" centers
- Cabinets can be stacked using mounting holes
- Durable gray powder coat finish
- Ships fully assembled

PART NO.	DIMENSIONS (IN.)			DRAWER DIMENSIONS (IN.)		
	WIDTH	DEPTH	HEIGHT	WIDTH	DEPTH	HEIGHT
18-DC	17.25	11.625	21.25	5.375	11.25	2.75



### 24 Opening Bin

- All welded, prime cold rolled steel
- Fully hemmed 1 1/8" bin fronts to hold labels and retain parts
- Roll-formed sides for increased strength and stability
- Ribbed and hemmed dividers provide added strength
- Modular with most 12" deep bins and drawer cabinets; mounting holes are located at both the top and bottom
- Durable gray powder coat finish
- Ships fully assembled

PART NO.	DIMENSIONS (IN.)			BIN DIMENSIONS (IN.)		
	WIDTH	DEPTH	HEIGHT	WIDTH	DEPTH	HEIGHT
24B-CABINET	33.75	12	23.875	5.375	11.875	5.5



**WARNING** These products can expose you to chemicals including NICKEL or LEAD, which are known to the state of California to cause cancer, and LEAD which is known to cause birth defects or other reproductive harm. For more information go to [www.P65Warnings.ca.gov](http://www.P65Warnings.ca.gov).



[Click here for CADs, Product Specifications or to Configure Parts Online](#)

### 40 Opening Bin

- All welded, prime cold rolled steel
- Fully hemmed 1 1/8" bin fronts to hold labels and retain parts
- Roll-formed sides for increased strength and stability
- Ribbed and hemmed dividers provide added strength
- Modular with most 12" deep bins and drawer cabinets; mounting holes are located at both the top and bottom
- Durable gray powder coat finish
- Ships fully assembled



PART NO.	DIMENSIONS (IN.)			BIN DIMENSIONS (IN.)		
	WIDTH	DEPTH	HEIGHT	WIDTH	DEPTH	HEIGHT
40B-CABINET	33.75	12	23.875	3.8125	11.875	3.8125

### Parker Brass Products Base Stand for 40B Cabinets

- Stands are 12" high
- Designed for use with 40B Cabinets
- Each stand includes a 15 piece bolt and nut set package for assembly



PART NO.	DIMENSIONS (IN.)		
	WIDTH	DEPTH	HEIGHT
40B-STAND	33.75	12	23.875

### Pneumatic Cabinet

- High quality all-steel construction
- Partitioning slots provide flexibility for customization
- Drawer locks limit access to prevent loss and improve safety when moved
- Drawer interlock prevent opening multiple drawers that could cause accidental tip over
- Available fitting and connector labels with photos make easy selection and restock easy
- Locking 4" heavy-duty casters
- Retainer top with a non-skid mat work surface



PART NO.	DIMENSIONS (IN.)			DRAWERS
	WIDTH	DEPTH	HEIGHT	
PNEU-CAB	22.1875	28.5	39.5	5-3" AND 1-9"

### Copper Tubing

Copper tubing meets A.S.T.M. specification B-280 (copper tube for refrigeration field service)

PART NO.	TUBE O.D.	TUBE I.D.	WALL THICKNESS	FEET PER COIL
50CT-2-30	1/8	.065	.030	50
50CT-3-30	3/16	.128	.030	50
50CT-4-30	1/4	.190	.030	50
50CT-5-32	5/16	.249	.032	50
50CT-6-32	3/8	.311	.032	50
50CT-8-32	1/2	.436	.032	50



**WARNING** These products can expose you to chemicals including NICKEL or LEAD, which are known to the state of California to cause cancer, and LEAD which is known to cause birth defects or other reproductive harm. For more information go to [www.P65Warnings.ca.gov](http://www.P65Warnings.ca.gov).

- A
- B
- C
- D
- E
- F
- G
- H
- I
- J
- K
- L
- M
- N
- O



# Tube Fabricating Equipment

Tube Cutters

Tube Benders

Flaring Tools

In-Ex<sup>®</sup> Tube Deburring Tool





**■ Tube Cutter**

**TC-1000-BPD**  
1/8" - 1 1/8"  
p. M5



**PTC-001**  
Plastic Tube cutter  
p. M5



**3000 71 11**  
For tubing &  
push-on hose  
p. M5



**■ Flaring Tools**

**945TH-BPD**  
Flaring Tool  
p. M6



**■ Tube Deburring Tool**

**226-BPD**  
Deburring Tool  
p. M6



**■ Replacement Parts**

**PTC-001RB**  
Replacement  
Blades  
p. M5



**⚠** WARNING These products can expose you to chemicals including NICKEL or LEAD, which are known to the state of California to cause cancer, and LEAD which is known to cause birth defects or other reproductive harm. For more information go to [www.P65Warnings.ca.gov](http://www.P65Warnings.ca.gov).



[Click here for CADs, Product Specifications or to Configure Parts Online](#)

# Tube Cutters

For hard or soft copper, aluminum, brass, thin wall steel, stainless steel, monel, titanium and other metal tubing. Rollers have flare cut-off groove, fold away reamer and spare cutting wheel.



PART NO.	DESCRIPTION
<b>TC-1000-BPD</b>	For 1/8" to 1 1/8" (4 to 28 mm) O.D. tubing, (1/8" to 1" nom.). Length: 4 15/16" Weight: 6 1/2 oz.

# Tube Cutters

Adjustable tube cutters to produce square cut ends with no external burr and minimum internal burring when used on fully annealed copper, brass, aluminum, and steel tubing. Features a hardened and burnished tool-steel cutting wheel, flare cut-off grooves in rollers for removal of old flares, swing-away reamer for removing internal burrs. Handle feeds and adjusts cutting wheel to uniformly cut tubing as the cutter is rotated.

NOTE: Tube cutters are not recommended for use with stainless steel tubing because of the work hardening effect. The use of a hacksaw with a "Tru-Kut" Sawing Vise or a rotary teeth saw is best recommended for stainless steel.



PART NO.	DESCRIPTION
<b>PTC-001</b>	Plastic Tube Cutter May be used with polyethylene, Polypropylene, nylon and other thermoplastic tubing. For tube O.D. sizes 1/8" to 1/2"
<b>PTC-001RB</b>	Replacement blades



PART NO.	DESCRIPTION
<b>3000 71 11</b>	Tube cutter for tubing & push-on hose For hoses up to 1" (25mm) Weight: 1.09 oz.
<b>3000 71 11 05</b>	Replacement blades

**WARNING** These products can expose you to chemicals including NICKEL or LEAD, which are known to the state of California to cause cancer, and LEAD which is known to cause birth defects or other reproductive harm. For more information go to [www.P65Warnings.ca.gov](http://www.P65Warnings.ca.gov).



- A
- B
- C
- D
- E
- F
- G
- H
- I
- J
- K
- L
- M
- N
- O

[Click here for CADs, Product Specifications or to Configure Parts Online](#)

- A
- B
- C
- D
- E
- F
- G
- H
- I
- J
- K
- L
- M
- N
- O

# Flaring Tools



PART NO.	DESCRIPTION
<b>945TH-BPD</b>	Rolo-flair® Manual Rotary Flaring Tool
	For soft metal tubing. Precision burnished 45° flares in tube sizes from 2 (1/8" O.D.) to 12 (3/4" O.D.) with an easy turn of the handle. For copper and aluminum alloy.
	Weight: 2 1/2 lbs.

# In-Ex® Tube Deburring Tool



PART NO.	DESCRIPTION
<b>226-BPD</b>	Insert tube into the convexed end of the In-Ex for inside deburring and the opposite end for outside deburring Rotate in either direction. Replacement blades can be ordered.
	Weight: 10 oz.

**WARNING** These products can expose you to chemicals including NICKEL or LEAD, which are known to the state of California to cause cancer, and LEAD which is known to cause birth defects or other reproductive harm. For more information go to [www.P65Warnings.ca.gov](http://www.P65Warnings.ca.gov).





# General Technical

Tubing Compatibility Chart

Manufacturing Techniques

Tube Line Fabrication Guide  
for Leak Free Systems

Thread Specifications

Flaring Instructions

Thread Designations and Standards  
for Threads Used in Fluid Connectors

Straight Thread Size Comparison Chart

S.A.E. Part Index

SAE Standards

U.L. Listed Fittings

Flow Curves

Flare and Thread Profiles

Pressure Conversions

English/Metric Conversions

Assembly Guides

Fluid Compatibility Guide

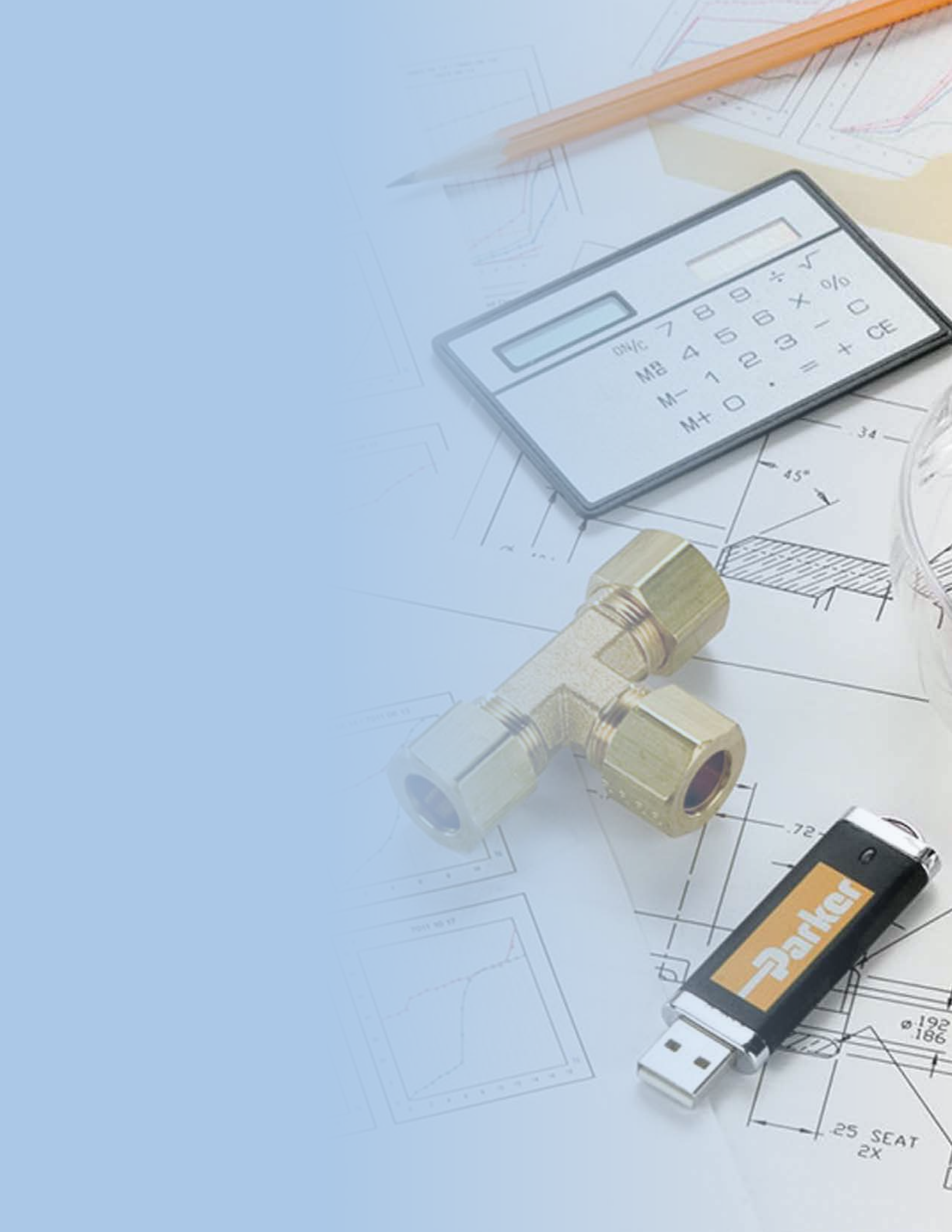

# Tubing Compatibility Chart

## Nomenclature

- PS** Plastic Sleeve & Tube Support Recommended
- TS** Tube Support Is Recommended
- BS** Brass Sleeve Recommended
- CL** Clamp Required
- MG** Metal Gripper Collet Recommended
- Orange** Tube/Fitting Combination Compatible
- Yellow** Tube/Fitting Combination Not Compatible

Product Sizes (inch)	Soft Metal Tubing			Parflex Thermoplastic Tubing											
	Copper	Aluminum	Steel	Industrial Tubing Series (Outside Diameter Shown)											
				Polyethylene E & EB Inch (4.5, 6.8, 10) Metric (6.8, 10, 12)	Polyethylene PEFR Inch (2.5, 4, 6.8)	Polyethylene HDPE Inch (4.6)	Nylon N Inch (2.2, 5.3, 4.5, 6.8) Metric (4mm - 20mm)	Nylon PAT Inch (2.4, 6.8, 10, 12)	Nylon NR Inch (2.3, 4.5, 6.8)	Nylon NTNA Inch (2.2, 5.3, 4.5, 6.8)	Polypropylene PP & PPB Inch (2.3, 4.5, 6.8, 10)	95U/95UM Series Inch (2.2, 5.4, 6.8, 12) Metric (4.6, 8, 10, 12)	Polyurethane HUIFR (Weld Tubing) Inch (4.6, 8)	Clear Vinyl Inch (1/8" - 2 1/2")	
Compression & Flare	Compression Inch (2, 3, 4, 5, 6, 7, 8, 10, 12)	BS	BS		PS TS	PS TS	PS TS	PS TS	PS TS	PS TS		PS TS			
	Compress-Align Inch (2, 3, 4, 5, 6, 8, 10, 12, 14, 16)				TS	TS	TS	TS	TS	TS		TS			
	Metric Compression Metric (4, 5, 6, 8, 10, 12, 14, 16, 18, 20, 22, 25, 28)				TS			TS		TS		TS	TS		
	Poly-Tite Inch (4, 5, 6, 8)	BS						BS				BS			
	Hi-Duty Inch (2, 3, 4, 5, 6, 8, 10)				TS	TS	TS	TS	TS	TS		TS			
	45 degree flare Inch (2, 3, 4, 5, 6, 8, 10, 12, 14)														
	Inverted Flare Inch (2, 3, 4, 5, 6, 8, 10, 12)														
Push-to-Connect	Fast & Tite Inch (4, 5, 6, 8, 10)												TS		TS
	Flow Controls Inch (2, 2.5, 3, 4, 5, 6, 8) Metric (4, 6, 8, 10, 12)												TS		
	Prestolok PLP Metal Inch (2, 2.5, 3, 4, 5, 6, 8)														
	LF3000 / Prestolok PLP Composite Inch (2, 2.5, 3, 4, 5, 6, 8, 10) Metric (3, 4, 6, 8, 10, 12, 14, 16)													TS	
	LF3600 / Prestolok PLM Metal Inch (2.5, 4, 5, 6, 8) Metric (4, 6, 8, 10, 12, 14)														
	LF3800 / Prestolok PLS Stainless Steel Inch (2.5, 3, 4, 5, 6, 8) Metric (4, 6, 8, 10, 12)														
	Liquifit Inch (2.5, 4, 6, 8) Metric (4, 6, 8, 10, 12)														
Barb	TrueSeal Inch (4, 5, 6, 8)	MG								MG		MG	TS		TS
	Par-Barb Inch (2, 3, 4, 5, 6, 8, 10, 12, 16, 20, 24) Inside Diameter														CL
	Dubl-Barb Inch (2.5, 4, 6, 8)														
	Hose Barb Inch (2, 3, 4, 5, 6, 8, 10, 12, 16) Inside Diameter														CL
DOT Transportation	Garden Hose														CL
	NTA Inch (3, 4, 6, 8, 10, 12)														
	Transmission Fittings Inch (2, 2.5)														
	Air Brake Inch (4, 6, 8, 10, 12, 16)														
	Air Brake Hose Inch (6, 8)														
	Vibra-Lok Inch (2, 3, 4, 5, 6, 8, 10, 12)														
	Prestomatic Inch (4, 6, 8, 10) Metric (6, 8, 10, 12, 16)														
	Brass PTC / Metric Prestomatic Inch (2.5, 3, 4, 6, 8, 10, 12)														
Composite PTC Inch (4, 6, 8, 10, 12)															
SAE Cartridges Inch (4, 6, 8, 10)															



# Tubing Compatibility Chart

Parflex Thermoplastic Tubing								IHP/HPD Hose		Nomenclature
Transportation Tubing				Fluoropolymer Tubing				GPH General Purpose Inch (3,4,6,8,12) Inside Diameter	Parker 271 hose (SAE J1402) Inch (6,8) Inside Diameter	
PET Air Brake (SAE J844) Inch (2,2.5,3,4,5,6,8,10,12)	Air Brake DIN 74324 (Nylon 12) Metric (4,6,8,10,12,15,16,18)	PET Diesel Fuel Sizes 4,6,8,10,12	HTFL Diesel Fuel Sizes 4,6,8,10,12	PFA Inch (3/32" - 1") Metric (4mm - 12mm)	FEP Inch (1/8" - 1") Metric (3mm - 12mm)	PTFE Inch (3/32" - 1,1") Metric (3mm - 16mm)	PVDF Inch (2,3,4,5,6,8,10,12,16)			
				PS TS	PS TS	PS TS	PS TS			Compression Inch (2,3,4,5,6,7,8,10,12)
				TS	TS	TS	TS			Compress-Align Inch (2,3,4,5,6,8,10,12,14,16)
				TS	TS	TS	TS			Metric Compression Metric (4,5,6,8,10,12,14,16,18,20,22,25,28)
										Poly-Tite Inch (4,5,6,8)
										Hi-Duty Inch (2,3,4,5,6,8,10)
										45 degree flare Inch (2,3,4,5,6,8,10,12,14)
										Inverted Flare Inch (2,3,4,5,6,8,10,12)
										Fast & Tite Inch (4,5,6,8,10)
										Flow Controls Inch (2,2.5,4,5,6,8) Metric (4,6,8,10,12)
										Prestolok PLP Metal Inch (2,2.5,3,4,5,6,8)
										Prestolok PLP Composite Inch (2,2.5,3,4,5,6,8,10) Metric (3,4,6,8,10,12,14,16)
										Prestolok PLM Metal Inch (2.5,4,5,6,8) Metric (4,6,8,10,12,14)
										Prestolok PLS Stainless Steel Inch (2.5,3,4,5,6,8) Metric (4,6,8,10,12)
										Liquifit Inch (2,5,4,6,8) Metric (4,6,8,10,12)
				MG	MG	MG	MG			TrueSeal Inch (4,5,6,8)
								CL		Par-Barb Inch (2,3,4,5,6,8,10,12,16,20,24) Inside Diameter
										Dubl-Barb Inch (2,5,4,6,8)
								CL		Hose Barb Inch (2,3,4,5,6,8,10,12,16) Inside Diameter
								CL		Garden Hose
										NTA Inch (3,4,6,8,10,12)
										Transmission Fittings Inch (2,2.5)
										Air Brake Inch (4,6,8,10,12,16)
										Air Brake Hose Inch (6,8)
										Vibra-Lok Inch (2,3,4,5,6,8,10,12)
										Prestomatic Inch (4,6,8,10) Metric (6,8,10,12,16)
										PTC Inch (2.5,3,4,6,8,10,12)
										SAE Cartridges Inch (4,6,8,10)

- A
- B
- C
- D
- E
- F
- G
- H
- I
- J
- K
- L
- M
- N
- O

# Manufacturing Techniques

## Parker Extruded fittings

Hexagon, round and shaped bars are extruded in the configuration required, drawn to size, cut to length and straightened. First a solid round billet (8 to 12 inches in diameter) is heated to the pliable state and forced by pressure of approximately 80,000 pounds per square inch through a die. The resulting continuous length of bar is cooled and then drawn through dies to the desired external size. (The drawing process also controls the temper.) After straightening, the bar is ready for machining.

The process produces a dense, nonporous material somewhat stronger in the longitudinal direction due to an orientated flow of the grain.

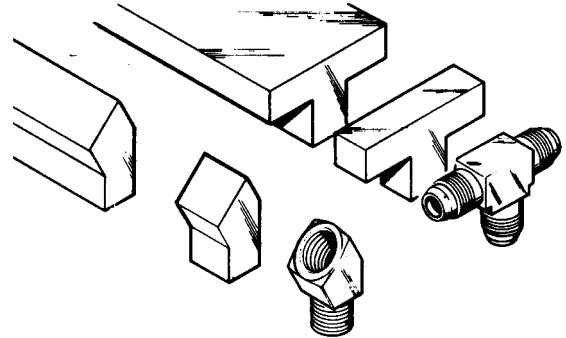

## Material used for Parker Brass Fittings

(Reference SAE J461)

Straight bodies:	barstock CA 360 or CA 345
Shape bodies:	extruded barstock CA 360
Shape bodies:	forged CA 377
Nuts:	barstock CA 360
Nuts:	forged CA 377

## Parker Forged Fittings

Material for forgings is extruded in round bars, cut to length and straightened. (At this point in the process, forging rod differs from round extruded machinable bars only in temper and chemical properties.) After straightening, the bars are cut again into slugs (short lengths), reheated to the pliable state and pressed under a pressure of approximately 25,000 pounds per square inch between upper and lower die cavities. After cooling the flash is trimmed away and the forging blank is ready for machining.

This process of forming under extreme pressure produces a uniformly dense material of exceptional strength. Because grain flow follows the contour, the fitting has high impact strength and is more resistant to mechanical shock and vibration.

***Of the major brass fittings producers, only Parker offers elbows and tees machined from both extruded and forged shapes.***

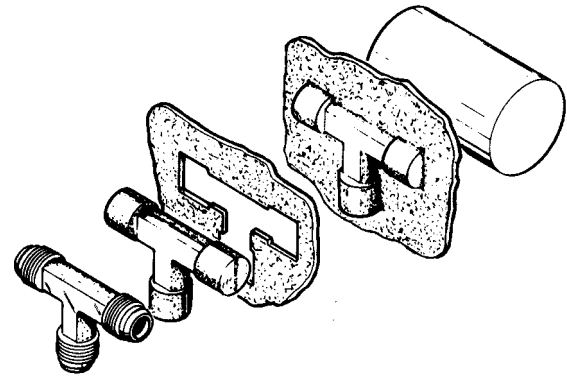



# Tube Line Fabrication Guide for Leak Free Systems

Every hydraulic, pneumatic and lubrication system requires some form of tube line fabrication and fitting installation for completion. Proper fabrication and installation are essential for the overall efficiency, leak free performance, and general appearance of any system.

Start by planning ahead. After sizing the tube lines and selecting the appropriate style of fitting, consider the following in the design of your system:

1. Accessibility of joints
2. Proper routing of lines
3. Adequate tube line supports
4. Available fabricating tools

## Routing of Lines

Routing of lines is probably the most difficult yet most significant of these system design considerations. Proper routing involves getting a connecting line from one point to another through the most logical path.

Always try to leave fitting joints as accessible as possible. Hard to reach joints are hard to assemble and tighten properly. Inaccessible joints are also more difficult and time consuming to service.

The most logical path should have the following characteristics:

- **Avoid excessive strain on joint** — A strained joint will eventually leak. (See Figures A14 through A21.)
- **Allow for expansion and contraction** — Use a “U” bend or a hose in long lines to allow for expansion and contraction. (See Figure A22.)
- **Allow for motion under load** — Even some apparently rigid systems do move under load. (See Figure A23.)
- **Get around obstructions without using excessive amount of 90° bends** — Pressure drop due to one 90° bend is greater than that due to two 45° bends. (See Figures A24 and A25.)
- Keep tube lines away from components that require regular maintenance. (See Figures A26 and A27.)
- Have a neat appearance and allow for easy troubleshooting, maintenance and repair. (See Figures A28 and A29.)

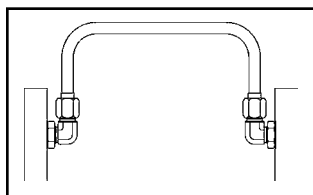

Fig. A14 — Correct Routing

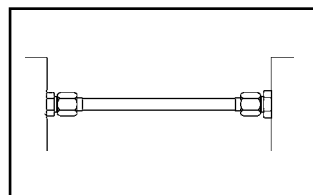

Fig. A15 — Incorrect Routing

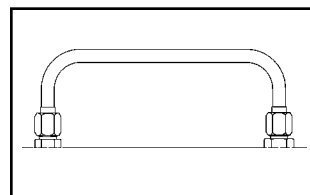

Fig. A18 — Correct Routing

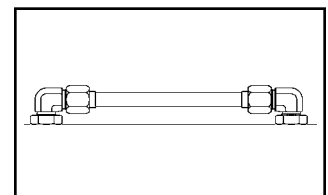

Fig. A19 — Incorrect Routing

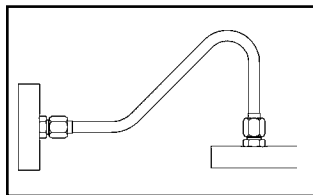

Fig. A16 — Correct Routing

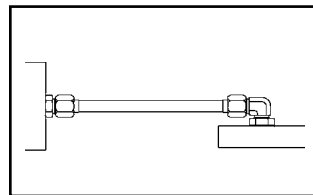

Fig. A17 — Incorrect Routing

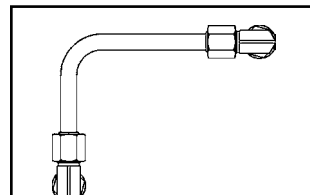

Fig. A20 — Correct Routing

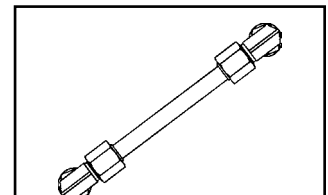

Fig. A21 — Incorrect Routing

(continued next page)

- A
- B
- C
- D
- E
- F
- G
- H
- I
- J
- K
- L
- M
- N
- O

- A
- B
- C
- D
- E
- F
- G
- H
- I
- J
- K
- L
- M
- N
- O

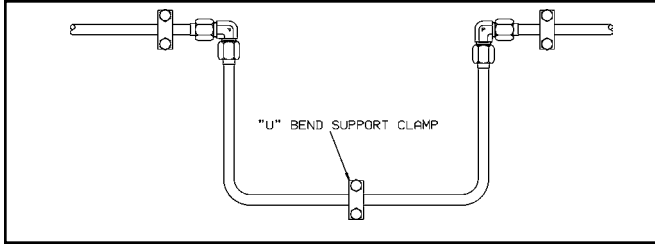

Fig. A22 — U-Bend Allowing Expansion and Contraction

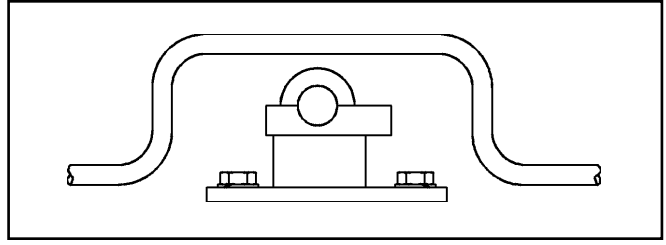

Fig. A25 — Incorrect

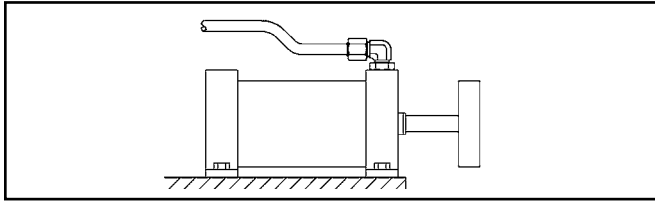

Fig. A23 — Bent Tube Allowing for Motion Under Load

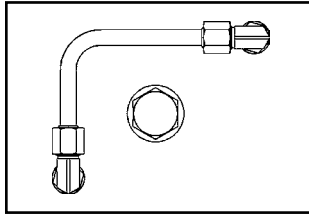

Fig. A26 — Correct

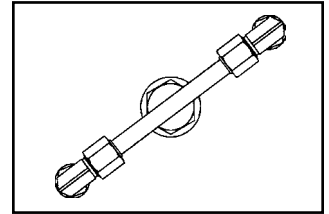

Fig. A27 — Incorrect

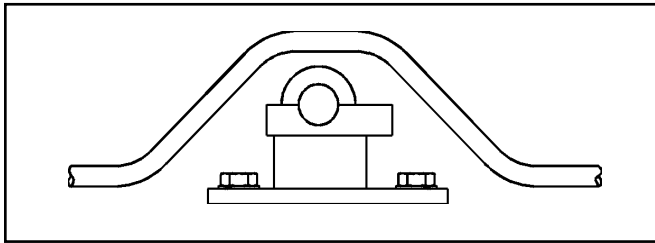

Fig. 24 — Correct

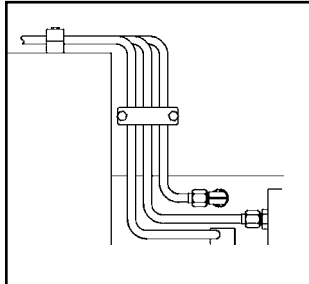

Fig. A28 — Correct

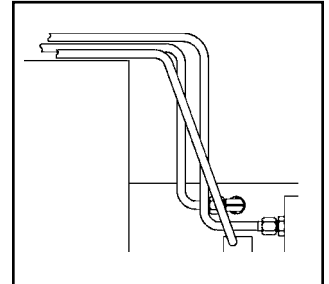

Fig. A29 — Incorrect

# Thread Specifications

## Dryseal Pipe Threads

All dryseal pipe threads are manufactured in accordance with the American National Standards Institute (ANSI) B1.20.3 specification and designed to seal pressure tight joints. The threads may incorporate the NPTF (National Standard Pipe Taper Fuel and Oil), PTF-SAE Short, PTF-SPL Short or PTF-SPL Extra Short form. Dryseal threads are used on brass products found within this catalog. Use of a thread sealant is recommended.

## Non-Dryseal Pipe Threads

All non-dryseal pipe threads are manufactured in accordance with the American National Standards Institute (ANSI) B1.20.1 specification. These tapered pipe threads are used on our carbon and stainless steel products. Use of a thread sealant is recommended.

## Nickel Plating

Nickel Plating is optional on standard product. Specifications for plating are not considered when standard product is manufactured. Since plating will alter thread pitch diameters, all plated threads should be qualified by functional fit with mating parts and not by standard thread gauging. Consult factory on plated product that will be qualified by standard thread gauging. These should be ordered as non-standards so product can be machined to pre-plated specifications.

Nickel plating provides a corrosion resistant coating which is desirable in many applications. Electrolytic nickel plating is the standard plating supplied unless otherwise specified. This will provide a uniform coverage of external surfaces; however, internal surfaces may be uncoated.

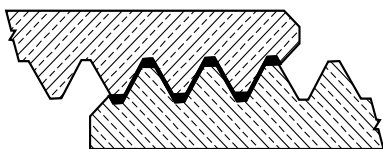

### Dryseal Pipe Thread

Metal to metal contact. Crests of thread are crushed by the roots when wrench-tightened to form seal.

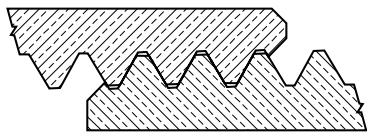

### Non-Dryseal Pipe Thread

Flanks are in contact with possible clearance between the roots and crests. Will not prevent spiral leakage

## Unified Threads

All threads in the columns headed "Straight Thread" found within this catalog are manufactured in accordance with the American National Standards Institute (ANSI) B1.1 specification.

## British Standard Pipe Threads BSPT and BSPP

### Pressure Tight

The British pipe threaded products found within this catalog intended for use where pressure tight joints are made on the threads are manufactured in accordance with British Standard (BS) 21 and International Standards Organization (ISO) 7-1. The threads are designated as follows:

- Rp: Internal parallel
- Rc: Internal taper
- Rs: Special external parallel
- R: External taper

Use of a thread sealant is recommended with the R series thread. An elastomeric peripheral seal should be used with the Rs thread.

### Non-Pressure Tight

All British Standard parallel pipe threads manufactured in this catalog according to BS2779 and ISO 228-1 are intended for use where pressure tight joints are not made on the threads. An elastomeric peripheral seal should be used. These threads are designated as follows:

- G: Internal Thread
- GA, External thread, tight tolerance classification
- GB, External thread, general purpose and assumed if no classification designation is given

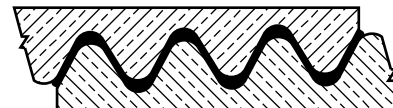

### BS21 British Standard Pipe Thread for Pressure Tight Joints

Metal to metal contact provides seal as tapered thread is wrench-tightened.

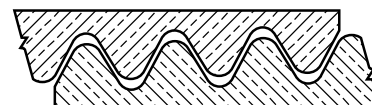

### BS2779 British Standard Pipe Thread for Non-Pressure Tight Joints

Thread tolerances allow for possible clearance between threads. Will not prevent leakage paths.

- A
- B
- C
- D
- E
- F
- G
- H
- I
- J
- K
- L
- M
- N
- O

A  
B  
C  
D  
E  
F  
G  
H  
I  
J  
K  
L  
M  
N  
O

## Pipe Thread Assembly

The two British Standard pipe thread forms used for Parker's standard product are manufactured in a tighter tolerance range than required by the standards in order to facilitate the assembly and mating of fittings produced by the two different standards. In general, BS21 threads do not necessarily mate with BS2779 threads at tolerance overlap conditions, but fittings located within this catalog can be assembled as follows:

External Thread	Mating Internal Thread
G-BS2779 (parallel)	G-BS2779 (parallel) Rp-BS21* (parallel)
Rs-BS21 (parallel)	Rp-BS21 (parallel) G-BS2779 (parallel)
R-BS21 (taper)	Rp-BS21 (parallel) Rc-BS21 (taper) G-BS2779 (parallel)

\*This thread must be manufactured within a reduced tolerance range to always assemble with the G series external thread.

## British Standard ISO Metric Screw Threads

They are commonly used in miniature pneumatic applications because of the availability of small thread diameters and are also used extensively in the automotive industry. There are two forms of sealing on metric screw threads.

- O-ring sealing into a profiled port in accordance with ISO 6149.
- Peripheral sealing with a copper or bonded washer in accordance with ISO 261 and 262.

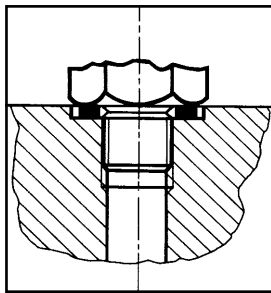

### Peripheral sealing of parallel threads

Pressure-tight joints of screwed connections with parallel threads are achieved by placing a seal between the two machined faces

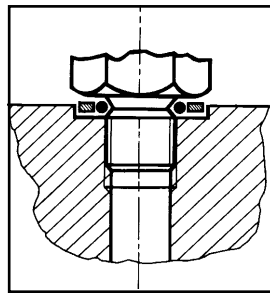

### Flat seals

Washers and rings are manufactured in many different materials including copper, aluminium, fiber, plastics, etc.

The tightening torque at assembly must be carefully selected so as to avoid compressing the seal to the point of extrusion. As a general rule, the fitting should be tightened with an additional 1/4 wrench turn from the fingertight position.

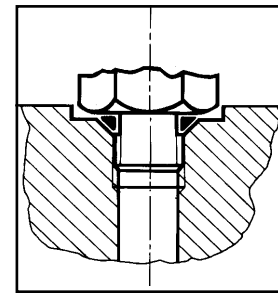

### O-rings

Depending upon the configuration of the female port or male thread, O-Ring seals are fitted with or without back-up washers, and can be fully retained in a captive seal.

# Flaring Instructions

In order to properly flare copping tubing for use with Parker 45° Flared Fittings and Inverted Flared Fittings, the following procedures and specifications should be met in preparation and make-up of flares.

**1. Cut tube with tube cutter:**

To minimize the burr and workhardening, use a light feed on the cutting wheel and make several revolutions.

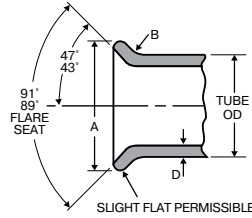

**2. Ream the tubing:**

Cutting with a tube cutter will always create a burr. The burr must be removed to obtain maximum sealing surface. Remove only the burr, do not remove material from the original wall thickness. Also clean the tube end thoroughly to remove burrs.

**3. Flare tubing:** Flare with a compression or generating type flaring tool. Follow tool manufacturer’s instructions for: (a) positioning the tube in tool and (b) for the correct number of turns on the feed handle.

**4. Inspect tubing:** The flare cone should be checked for a smooth surface on the i.D. Of the cone and measure with micrometer over largest o.D. For proper size. (See dimensions below for flare size for each tubing size.)

NOMINAL TUBE	A SINGLE FLARE DIAMETER		B SINGLE FLARE RADIUS	D SINGLE FLARE WALL THICKNESS
	IN	MAX. IN	MIN. IN	MAX. IN
1/8	.181	.171	+/- 0.01 IN	.035
3/16	.249	.239	.02	.035
1/4	.325	.315	.02	.049
5/16	.404	.388	.02	.049
3/8	.487	.471	.02	.065
7/16	.561	.545	.02	.065
1/2	.623	.607	.02	.083
9/16	.676	.660	.02	.083
5/8	.748	.732	.02	.095
3/4	.916	.900	.02	.109
7/8	1.041	1.025	.02	.109
1	1.157	1.141	.02	.120

# Thread Designations and Standards for Threads Used in Fluid Connectors

	ABBREVIATION	DESCRIPTION	APPLICABLE STD.
STRAIGHT PIPE	NPSC	AMERICAN STANDARD STRAIGHT PIPE THREADS IN PIPE COUPLINGS	ANSI B1.20.1 FED-STD-H28/7
	NPSF	DRYSEAL AMERICAN STANDARD FUEL INTERNAL STRAIGHT PIPE THREADS (GENERALLY SED IN SOFT OR DUCTILE MATERIALS TO MATE WITH NPTF EXTERNAL TAPER THREADS)	SAE J476 ANSI B1.20.3 FED-STD-H28/8
	NPSI	DRYSEAL AMERICAN INTERMEDIATE INTERNAL STRAIGHT PIPE THREADS (FOR BRITTLE OR HARD MATERIALS; INTENDED TO MATE WITH PTF-SAE SHORT EXTERNAL TAPER THREADS)	SAE J476 ANSI B1.20.3 FED-STD-H28/8
	NPSM	AMERICAN STANDARD STRAIGHT PIPE THREADS FOR FREE-FITTING MECHANICAL JOINTS FOR FIXTURES (THESE THREADS FIT FREELY OVER NPTF THREADS. THEY ARE USED IN SWIVEL NUTS OF 07 ADAPTERS)	ANSI B1.20.1 FED-STD-H28/7
TAPER PIPE	ANPT	AERONAUTICAL NATIONAL TAPER PIPE THREADS (SIMILAR TO NPT WITH VARIOUS ADDITIONAL REQUIREMENTS IN GAGING)	MIL-P-7105
	NPT	AMERICAN STANDARD TAPER PIPE THREADS FOR GENERAL USE	ANSI B1.20.1 FED-STD-H28/7
	NPTF	DRYSEAL AMERICAN STANDARD TAPER PIPE THREADS (USED IN ALL OF OUR STEEL AND BRASS FITTINGS)	SAE J476 ANSI B1.20.3 FED-STD-H28/8
	PTF - SAE SHORT	DRYSEAL SAE SHORT TAPER PIPE THREADS (MAINLY USED IN LOW PRESSURE PNEUMATIC AND FUEL APPLICATIONS)	SAE J476 ANSI B1.20.3 FED-STD-H28/8
	PTF - SPL SHORT¹	DRYSEAL SPECIAL SHORT TAPER PIPE THREADS	ANSI B1.20.3
	PTF - SPL EXTRA SHORT¹	DRYSEAL SPECIAL EXTRA SHORT TAPER PIPE THREADS	ANSI B1.20.3

Continued next page



	ABBREVIATION	DESCRIPTION	APPLICABLE STD.
UNIFIED THREADS	UN	UNIFIED CONSTANT PITCH THREADS (STANDARD SERIES: 4, 6, 8, 12, 16, 20, 28, 32)	ANSI B1.1 ED-STD-H28/2
	UNC	UNIFIED COARSE THREADS	ANSI B1.1 FED-STD-H28/2
	UNEF	UNIFIED EXTRA FINE THREADS	ANSI B1.1 FED-STD-H28/2
	UNF	UNIFIED FINE THREADS	ANSI B1.1 FED-STD-H28/2
	UNS	UNIFIED SPECIAL PITCH THREADS	ANSI B1.1 FED-STD-H28/3
	UNJ	UNIFIED CONTROLLED ROOT RADIUS THREADS	ANSI B1.15 FED-STD-H28/4
METRIC THREADS	M	METRIC SCREW THREADS — M PROFILE	ISO 261 ANSI B1.13M FED-STD-H28/21
	M — KEG	METRIC TAPER THREADS (MAINLY USED IN GERMANY)	DIN 158
BRITISH STANDARD	R (BSPT)	BRITISH STANDARD TAPER PIPE THREADS, EXTERNAL	BS 21 ISO 7/1
	RC (BSPT)	BRITISH STANDARD TAPER PIPE THREADS, INTERNAL	BS 21 ISO 7/1
	RP OR G (BSPP)	BRITISH STANDARD PIPE (PARALLEL) THREADS	BS 2779 ISO 228/1
JAPANESE STANDARD	PF <sup>2</sup>	JIS PARALLEL PIPE THREADS	JIS B202 ISO 228/1
	PT <sup>2</sup>	JIS TAPER PIPE THREADS	JIS B203 ISO 7/1
	PS	JIS PARALLEL INTERNAL PIPE THREADS (TO MATE WITH PT THREADS)	JIS B203

Table A48 — Thread Designations and Standards for Threads Used in Fluid Connectors

- Used in some pneumatic components where shortened thread depth is required because of lack of enough material due to component size limitations.
- PF and PT threads are functionally interchangeable with BSPP and BSPT threads, respectively. These are old designations. They are being replaced with G (for PF) and R and Rc (for PT) as documents are revised.

## Straight Thread Size Comparison Chart

	TUBE O.D.										
	1/8	3/16	1/4	5/16	3/8	7/16	1/2	5/8	3/4	7/8	1
SAE 45° FLARED	5/16 -24	3/8 -24	7/16 -20	1/2 -20	5/8 -18	11/16 -16	3/4 -16	7/8 -14	1-1/16 -14	1-1/4 -12	-
INVERTED FLARED	5/16 -28	3/8 -24	7/16 -24	1/2 -20	5/8 -18	11/16 -18	3/4 -18	7/8 -18	1-1/16 -16	1-3/16 -16	-
AIR BRAKE/NTA	-	-	7/16 -24	-	17/32 -24	-	11/16 -20	13/16 -18	1 -18	-	1-1/4 -16
STANDARD COMPRESSION / COMPRESS-ALIGN	5/16 -24	3/8 -24	7/16 -24	1/2 -24	9/16 -24	5/8 -24	11/16 -20	13/16 -18	1 -18	1-1/8 -18	1-1/4 -18
POLY-TITE			3/8 -24	7/16 -24	1/2 -24	-	11/16 -20	-	-	-	-
VIBRA-LOK	3/8 -24	-	1/2 -24	9/16 -24	5/8 -24	-	13/16 -18	1 -18	1-1/8 -18	-	-
V510 BALL VALVES	-	-	7/16 -20	-	9/16 -18	-	3/4 -16	7/8 -14	1-1/16 -12	-	1-5/16 -12
HI-DUTY FLARELESS TUBE FITTINGS	5/16 -24	3/8 -24	7/16 -20	1/2 -20	9/16 -20	-	11/16 -16	7/8 -18	-	-	-

# S.A.E. Part Index

<u>PART NO.</u>	<u>PAGE</u>	<u>PART NO.</u>	<u>PAGE</u>	<u>PART NO.</u>	<u>PAGE</u>	<u>PART NO.</u>	<u>PAGE</u>
SAE 010101 .....	H8	SAE 010202 .....	H10	SAE 060102 BA.....	G9	SAE 100203 BA.....	F9
SAE 010102 .....	H9	SAE 010203 .....	H11	SAE 060103 BA.....	G9	SAE 100302 BA.....	F9
SAE 010103 .....	H9	SAE 010302 .....	H11	SAE 060110 .....	G8	SAE 100401 BA.....	F8
SAE 010104 .....	H8	SAE 010401 .....	H10	SAE 060111 .....	G8	SAE 100424 BA.....	F9
SAE 010105 .....	H12	SAE 010424 .....	H11	SAE 060115 .....	G8	SAE 100425 BA.....	F9
SAE 010106 .....	H12	SAE 010425 .....	H10	SAE 060201 BA .....	G10	SAE 120101 BA.....	F13
SAE 010107 .....	H12	SAE 040101 .....	H14	SAE 060202 BA .....	G10	SAE 120102 BA.....	F13
SAE 010108 .....	H7	SAE 040102 .....	H14	SAE 060203 BA .....	G11	SAE 120103 BA.....	F13
SAE 010109 .....	H12	SAE 040103 .....	H14	SAE 060401 BA .....	G10	SAE 120111 .....	F13
SAE 010110 .....	H8	SAE 040110 .....	H14	SAE 060424 BA .....	G11	SAE 120115 .....	F13
SAE 010111 .....	H8	SAE 040202 .....	H15	SAE 060425 BA .....	G11	SAE 120201 BA.....	F13
SAE 010112 .....	H12	SAE 040203 .....	H15	SAE 100101 BA.....	F7	SAE 120202 BA.....	F14
SAE 010113 .....	H7	SAE 040302 .....	H15	SAE 100102 BA.....	F8	SAE 120203 BA.....	F14
SAE 010114 .....	H7	SAE 040401 .....	H14	SAE 100103 BA.....	F8	SAE 120302 BA.....	F14
SAE 010165 .....	H7	SAE 040424 .....	H15	SAE 100110 .....	F7	SAE 120401 BA.....	F13
SAE 010166 .....	H7	SAE 040425 .....	H15	SAE 100115 .....	F7	SAE 120424 BA.....	F14
SAE 010167 .....	H7	SAE 040427 .....	H15	SAE 100201 BA.....	F8	SAE 120425 BA.....	F14
SAE 010201 .....	H11	SAE 060101 BA.....	G8	SAE 100202 BA.....	F9		

## SAE Standards

**(Current)**

- J246:** Spherical and Flanged Sleeve (Compression) Tube Fittings  
Tubing: Copper and J844 Nylon  
Fittings: NTA and Air Brake
- J476:** Dryseal Pipe Threads
- J512:** Automotive Tube Fittings  
Tubing: Copper and Nylon  
Fittings: 45° Flare, Inverted Flare, Compression
- J513:** Refrigeration Tube Fittings  
Tubing: Annealed Copper  
Fittings: 45° Flare
- J530:** Automotive Pipe Fittings  
Fittings: Pipe
- J531:** Automotive Pipe, Filler and Drain Plugs  
Fittings: Pipe Plugs
- J844:** Nonmetallic Air Brake System Tubing  
Tubing: Non-reinforced Type A, reinforced Type B
- J1131:** Performance Requirements for SAE J844 Nonmetallic Tubing and Fitting Assemblies Used in Automotive Air Brake Systems  
Tubing: J844 Nylon  
Fittings: NTA and Prestomatic
- J1615:** Thread Sealants
- J2494:** Brass Body Push-to-Connect Fittings  
Tubing: J844 Nylon  
Fittings: Prestomatic



A

B

C

D

E

F

G

H

I

J

K

L

M

N

O

# U.L. Listed Fittings

Many of the Fluid System Connectors Division's fittings have been listed by the Underwriter's Laboratory. The listings fall under 1 of 3 categories, depending upon application. Underwriter's requires that the smallest unit package carry the U.L. symbol and each carton be printed in accordance with the specification of each category.

## List of U.L. Fittings

FITTINGS, FLAMMABLE LIQUID			
1F	62C	168CA	252IFHD
2GF	62CA	169C	256IF
3GF	62CABH	169CA	259IFHD
14FL	62CBH	170C	264C
14FSV	66C	170CA	264CA
14FSX	66CA	171C	265C
41FL	68C	171CA	265CA
41FS	68CA	172C	269C
41FX	144F	172CA	269CA
41IF	145F	176C	270C
41IFS	147F	176CA	270CA
42F	149F	177C	639C
42IFHD	150F	177CA	639CA
46F	151F	244F	639F
46IFHD	155F	244IFHD	640F
48F	159F	245IFHD	660FHD
48IFHD	164C	249F	661FHD
60C	164CA	249IF	664FHD
61C	165C	249IFHD	
61CA	165CA	250IFHD	
61CL	168C	251IFHD	

FITTINGS, FUEL EQUIPMENT, MARINE			
2GF	144F	155F	664FHD
3GF	145F	159F	
14FL	147F	639F	
42F	149F	640F	
46F	150F	660FHD	
48F	151F	661FHD	

SHUT-OFF VALVES, FLAMMABLE LIQUIDS, LP GAS AND COMPRESS GAS		
XV520P-4	XV520P-20	XV500P-20
XV520P-6	XV520P-24	XV500P-24
XV520P-8	XV520P-32	XV500P-32
XV520P-12	XV520P-40	
XV520P-16	XV520P-48	



# Flow Curves

87 PSI (5.9 bar) ■ Return Direction ■ Controlled Direction N = Number of Turns F = Flow in SCFM

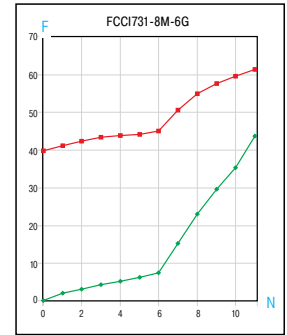
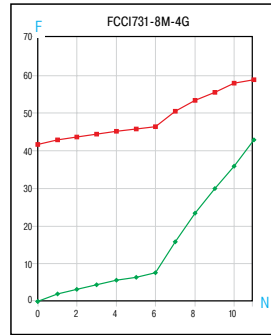
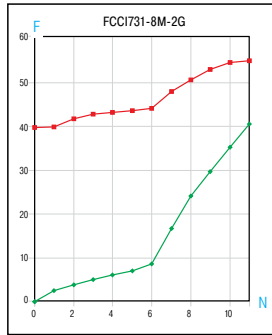
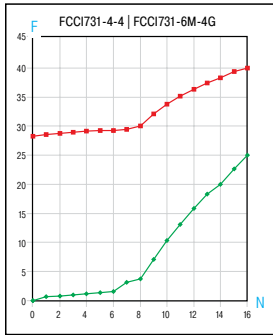
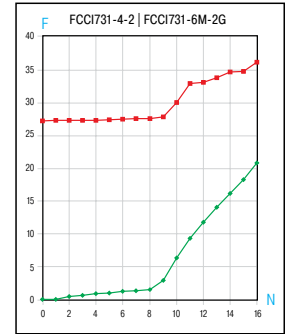
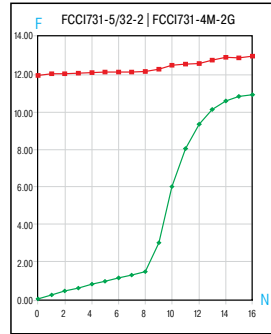
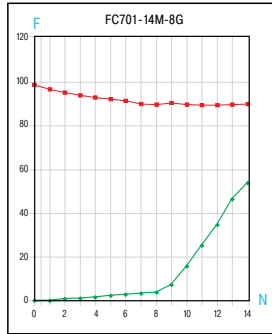
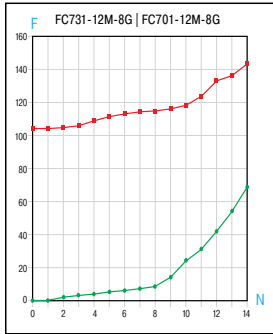
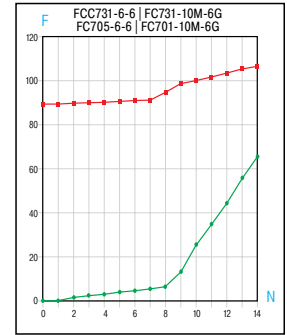
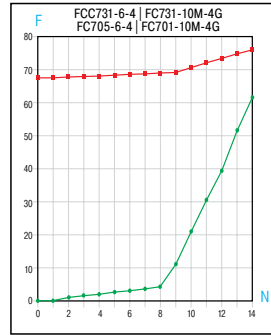
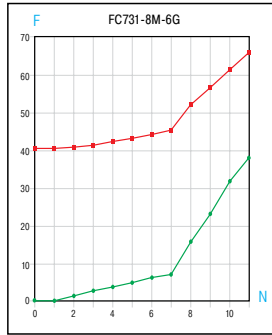
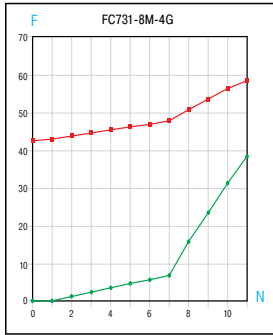
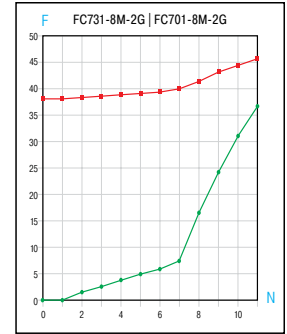
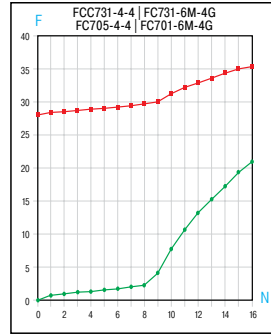
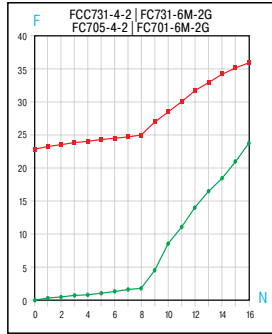
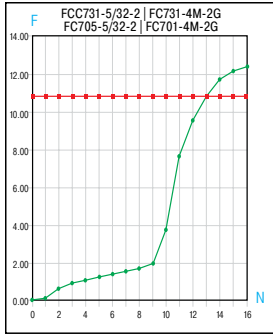

87 PSI (5.9 bar) ■ Return Direction ■ Controlled Direction N = Number of Turns F = Flow in SCFM

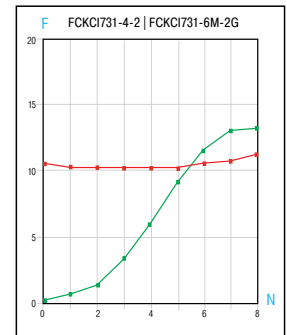
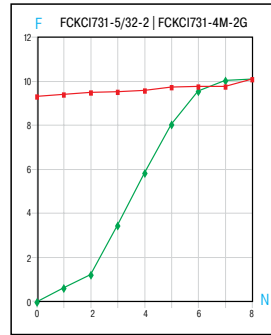
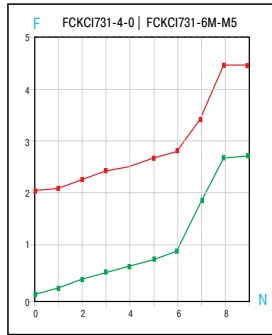
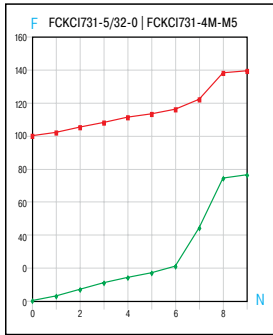
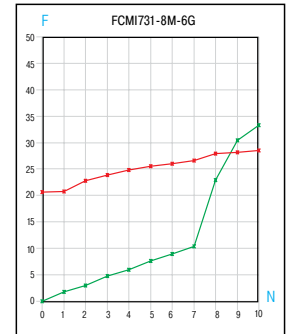
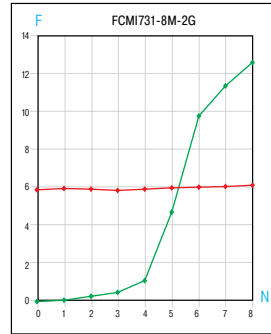
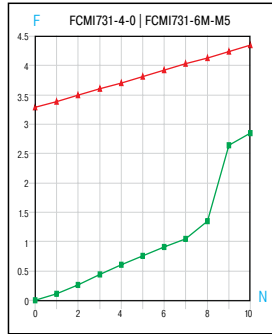
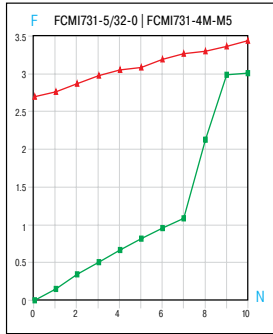
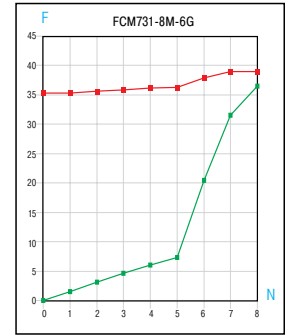
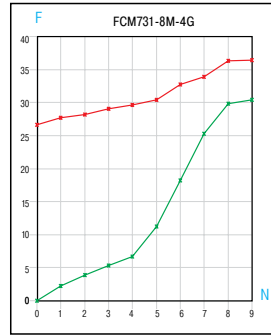
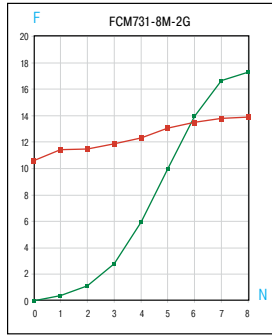
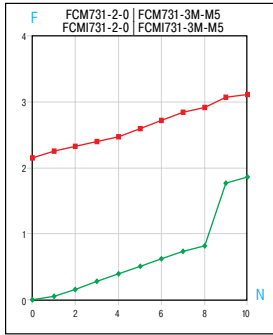
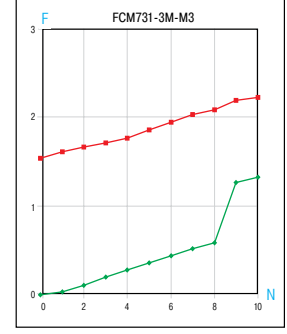
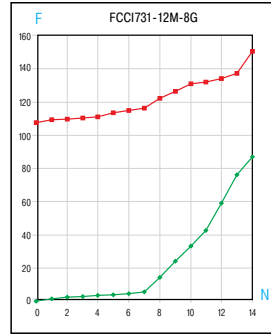
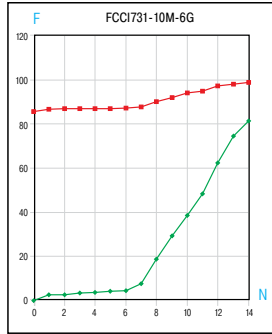
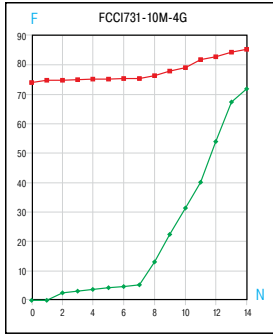

87 PSI (5.9 bar) ■ Return Direction ■ Controlled Direction N = Number of Turns F = Flow in SCFM

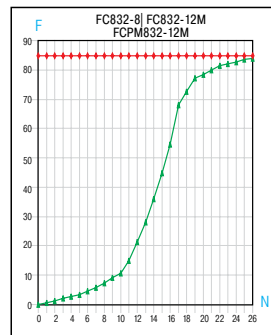
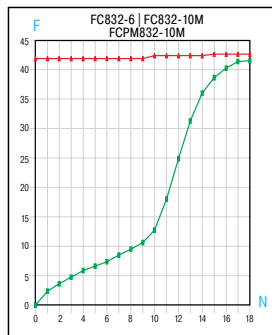
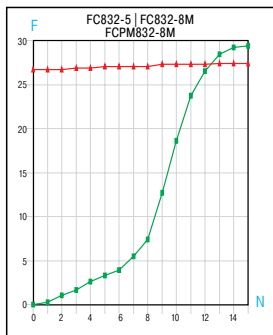
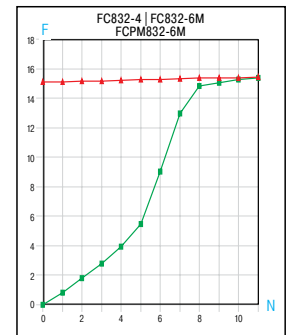
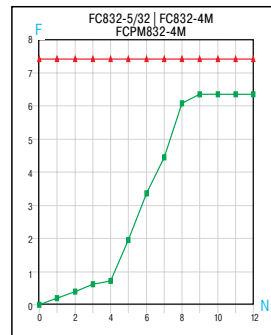
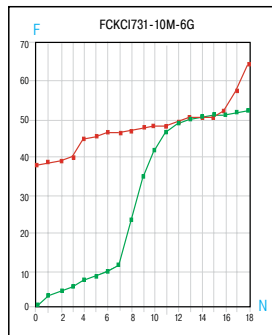
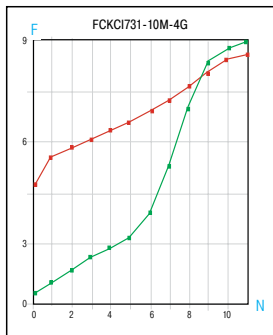
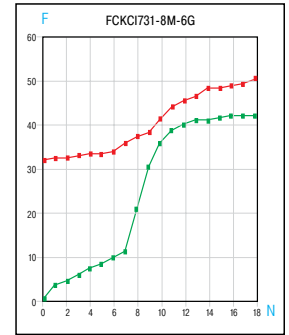
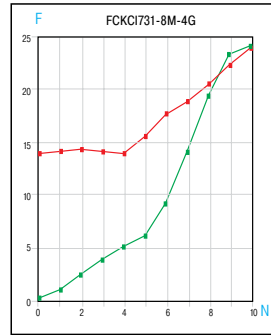
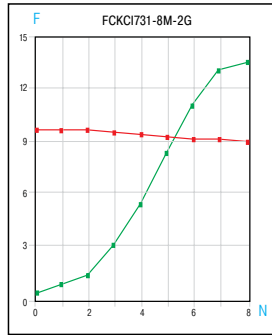
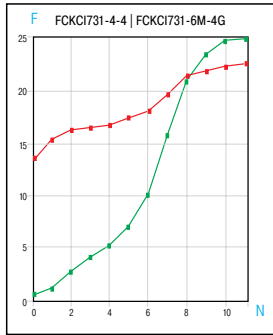

- A
- B
- C
- D
- E
- F
- G
- H
- I
- J
- K
- L
- M
- N
- O

87 PSI (5.9 bar) Return Direction Controlled Direction N = Number of Turns F = Flow in SCFM

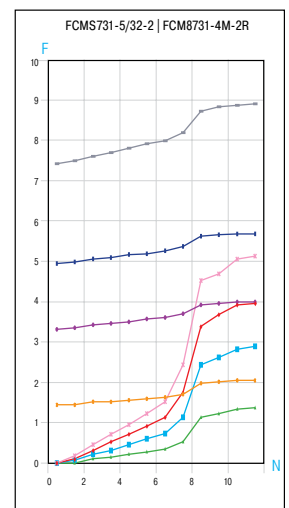
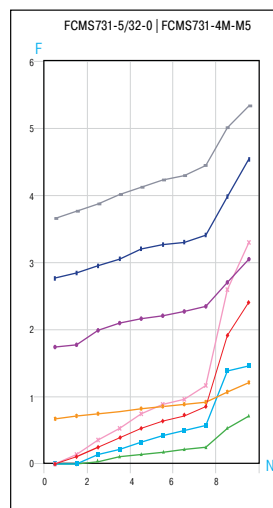
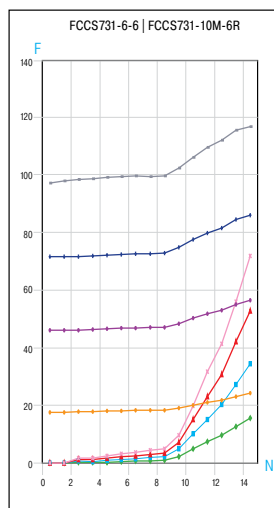
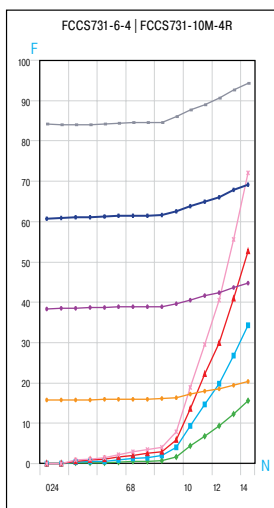
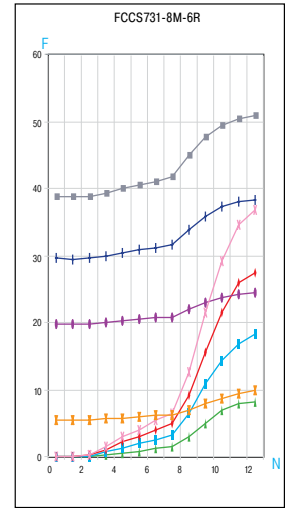
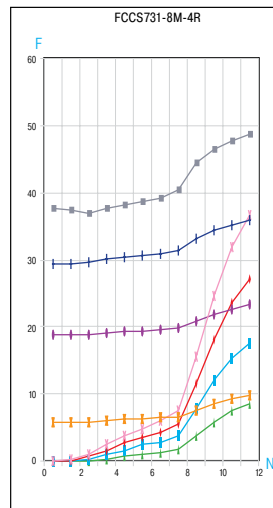
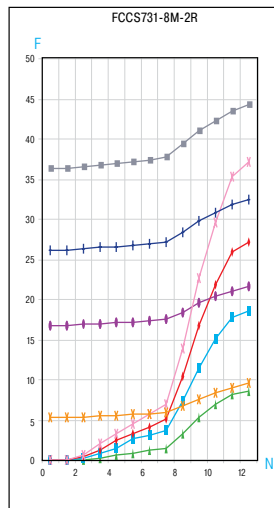
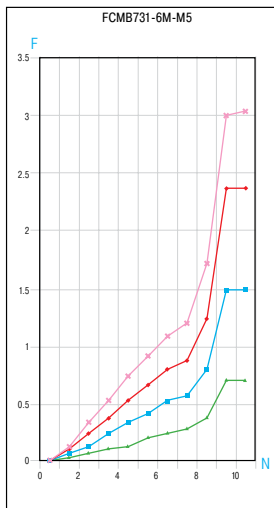
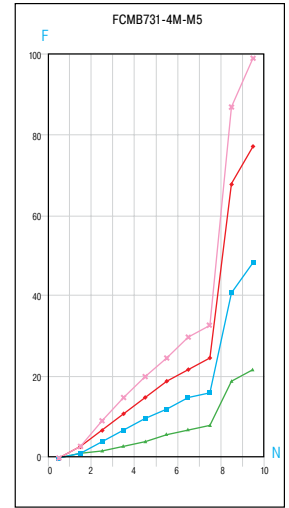
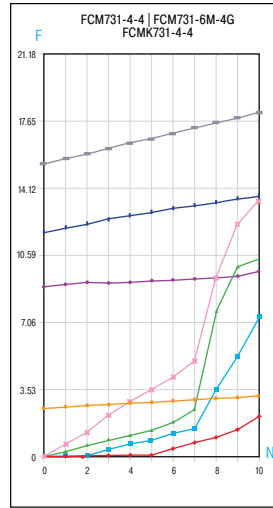
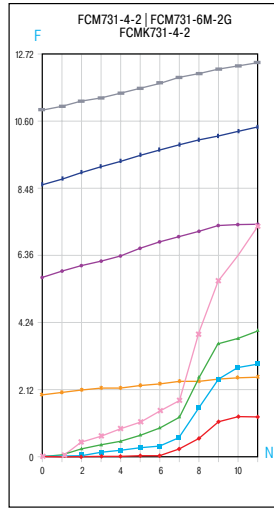
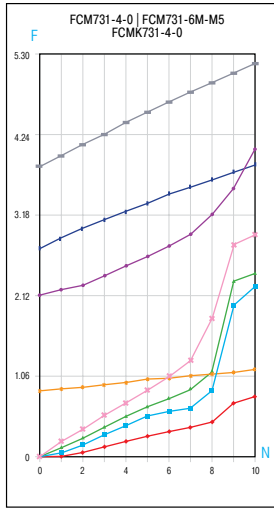

— Controlled Direction – 14.5 PSI (0.9 bar)      — Controlled Direction – 43.5 PSI (2.9 bar)  
— Controlled Direction – 72.5 PSI (4.9 bar)      — Controlled Direction – 101.5 PSI (6.9 bar)  
— Return Direction – 14.5 PSI (0.9 bar)      — Return Direction – 43.5 PSI (2.9 bar)  
— Return Direction – 72.5 PSI (4.9 bar)      — Return Direction – 101.5 PSI (6.9 bar)

A  
B  
C  
D  
E  
F  
G  
H  
I  
J  
K  
L  
M  
N  
O



87 PSI (5.9 bar) ■ Return Direction ■ Controlled Direction ■ N = Number of Turns F = Flow in SCFM

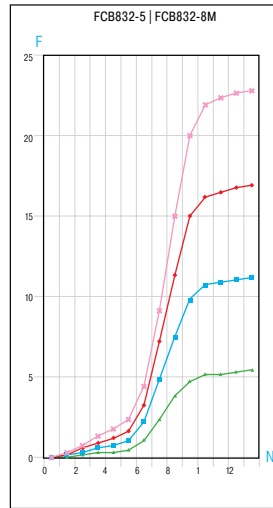
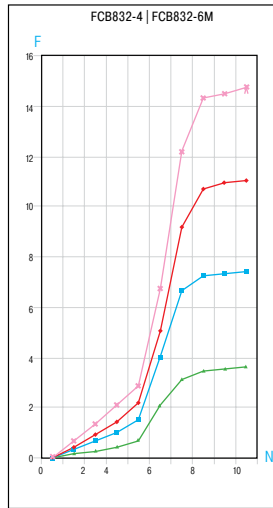
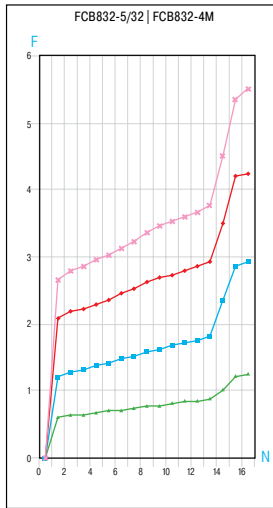
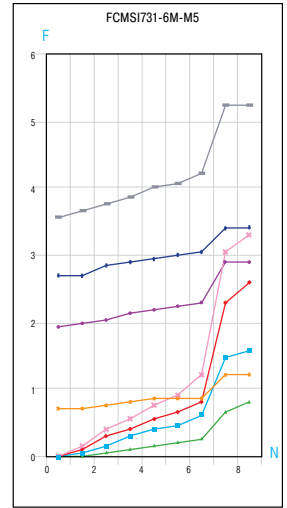
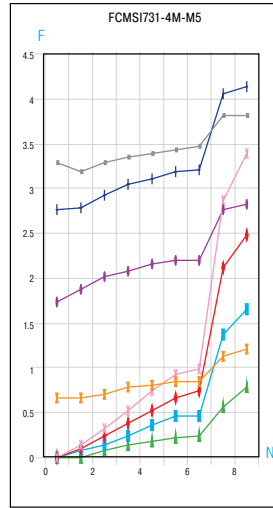
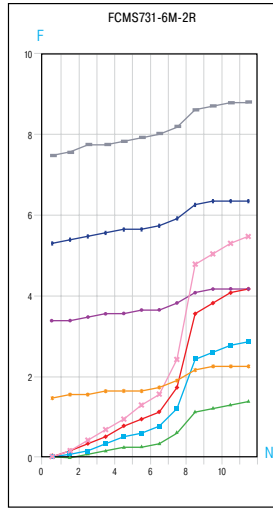
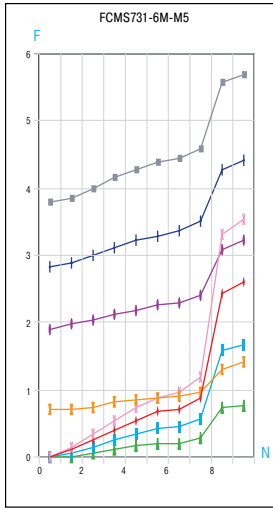

<span style="color: green;">—</span> Controlled Direction – 14.5 PSI (0.9 bar)	<span style="color: blue;">—</span> Controlled Direction – 43.5 PSI (2.9 bar)
<span style="color: red;">—</span> Controlled Direction – 72.5 PSI (4.9 bar)	<span style="color: pink;">—</span> Controlled Direction – 101.5 PSI (6.9 bar)
<span style="color: orange;">—</span> Return Direction – 14.5 PSI (0.9 bar)	<span style="color: purple;">—</span> Return Direction – 43.5 PSI (2.9 bar)
<span style="color: blue;">—</span> Return Direction – 72.5 PSI (4.9 bar)	<span style="color: grey;">—</span> Return Direction – 101.5 PSI (6.9 bar)

- A
- B
- C
- D
- E
- F
- G
- H
- I
- J
- K
- L
- M
- N
- O



# Flare and Thread Profiles

## SAE (JIC) 37° Flare Nose Sizes

Actual Size

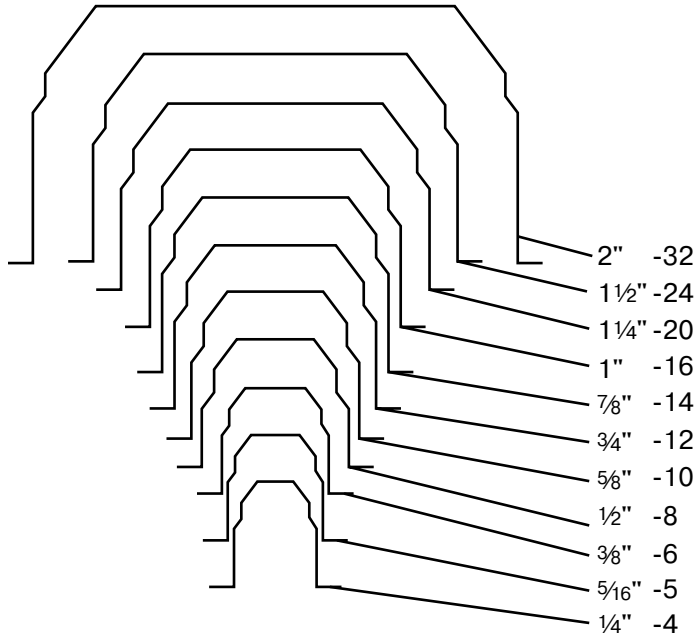

## SAE 45° Flare Nose Sizes

Actual Size

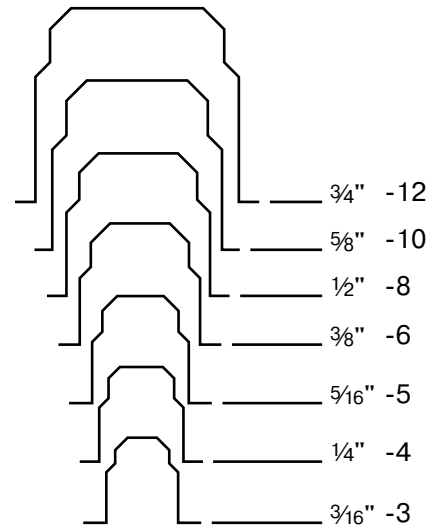

## Male Pipe Thread Sizes

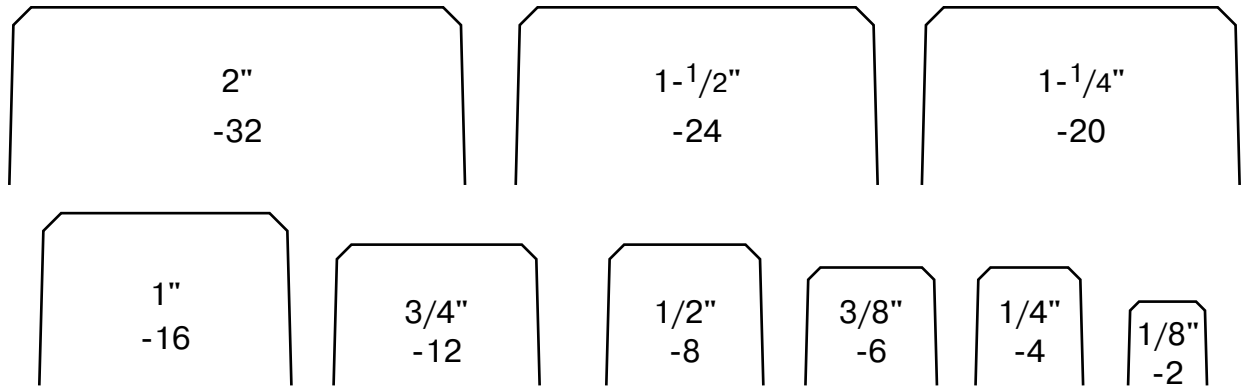

## Actual Outside Diameters of Tubing

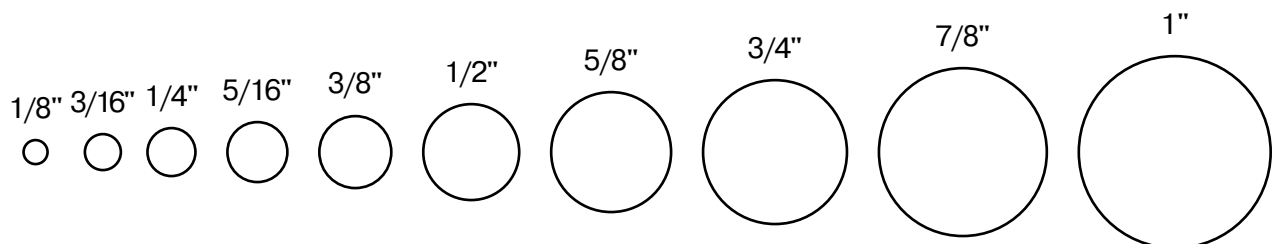

# Pressure Conversions

KILOPASCALS (KPA)	MEGAPASCALS (MPA)	BAR (bar)	KILOGRAMS PER SQUARE CENTIMETER (KGF/CM2)	POUNDS PER SQUARE INCH (PSI)
100	1.0	1	1.02	14.50
200	.2	2	2.04	29.00
300	.3	3	3.06	43.50
400	.4	4	4.08	58.00
500	.5	5	5.10	72.50
600	.6	6	6.12	87.00
700	.7	7	7.14	101.50
800	.8	8	8.16	116.00
900	.9	9	9.18	130.50
1000	1.0	10	10.20	145.00
2000	2.0	20	20.40	290.10
3000	3.0	30	30.60	435.10
4000	4.0	40	40.80	580.20
5000	5.0	50	51.00	725.20
6000	6.0	60	61.20	870.20
7000	7.0	70	71.40	1015.30
8000	8.0	80	81.60	1160.30
9000	9.0	90	91.80	1305.30
10000	10.0	100	102.00	1450.00
20000	20.0	200	204.00	2901.00
30000	30.0	300	306.00	4351.00
40000	40.0	400	408.00	5802.00
50000	50.0	500	510.00	7252.00
60000	60.0	600	612.00	8702.00
70000	70.0	700	714.00	10153.00
80000	80.0	800	816.00	11603.00
90000	90.0	900	918.00	13053.00
100000	100.0	1000	1020.00	14504.00
200000	100.0	2000	2040.00	29008.00
300000	300.0	3000	3060.00	43511.00

POUNDS PER SQUARE INCH (PSI)	KILOPASCALS (KPA)	MEGAPASCALS (MPA)	BAR (bar)	KILOGRAMS PER SQUARE CENTIMETER (KGF/CM2)
10	68.90	.07	.70	.70
20	137.90	.14	1.41	1.41
30	206.80	.21	2.10	2.11
40	275.80	.28	2.80	2.81
50	344.70	.34	3.40	3.52
60	413.70	.41	4.10	4.22
70	482.60	.48	4.80	4.92
80	551.60	.55	5.50	5.63
90	620.50	.62	6.20	6.33
100	689.00	.70	6.90	7.00
200	1379.00	1.40	13.80	14.10
300	2068.00	2.10	20.70	21.10
400	2758.00	2.80	27.60	28.10
500	3447.00	3.40	34.50	35.20
600	4137.00	4.10	41.40	42.20
700	4826.00	4.80	48.30	49.20
800	5516.00	5.50	55.20	56.30
900	6205.00	6.20	62.10	63.30
1000	6895.00	6.90	68.90	70.30
2000	13790.00	13.80	137.90	140.70
3000	20684.00	20.70	206.80	211.00
4000	27579.00	27.60	275.80	281.30
5000	34474.00	34.50	344.70	351.60
6000	41369.00	41.40	413.70	421.90
7000	48263.00	48.30	482.60	492.30
8000	55158.00	55.20	551.60	562.60
9000	62053.00	62.10	620.50	632.90
10000	68948.00	68.90	689.00	703.00
20000	137895.00	137.90	1379.00	1406.00
30000	206843.00	206.80	2068.00	2110.00
40000	275790.00	275.80	2758.00	2813.00

- A
- B
- C
- D
- E
- F
- G
- H
- I
- J
- K
- L
- M
- N
- O



# Tube Insertion Depths

This engineering standard covers the tube insertion depths and minimum depths to pass thru the o-ring. The depths are used for conveying information to customers and are meant to be used only as a guideline.



## Brass Prestolok Plus (PLP Metal)

TUBE SIZE	FULL INSERTION DEPTH (IN.)	MINIMUM O-RING DEPTH (IN.)
1/8"	.64	.48
5/32"	.64	.48
3/16"	.67	.48
1/4"	.67	.49
5/16"	.77	.51
3/8"	.78	.51
1/2"	.85	.58

## LF3000 (PLP Composite) & LIQUIfit

TUBE SIZE	FULL INSERTION DEPTH (IN.)	MINIMUM O-RING DEPTH (IN.)
1/8"	.46	.38
3/16"	.65	.56
1/4"	.58	.44
3/8"	.81	.62
1/2"	1.09	.84
4MM	.51	.39
6MM	.58	.45
8MM	.73	.55
10MM	.81	.62
12MM	.97	.73
14MM	1.08	.83
16MM	1.15	.89

## LF3600 (PLM) & LF3800 (PLS)

TUBE SIZE	FULL INSERTION DEPTH (IN.)	MINIMUM O-RING DEPTH (IN.)
1/4"	.66	.55
3/8"	.88	.73
1/2"	.89	.74
4MM	.57	.49
6MM	.68	.57
8MM	.71	.62
10MM	.90	.75
12MM	.96	.78
14MM	1.00	.82

## Carstick

TUBE SIZE	FULL INSERTION DEPTH (IN.)	MINIMUM O-RING DEPTH (IN.)
1/8"	.46	.38
1/4"	.75	.55
3/8"	.86	.68
1/2"	1.16	.92
4MM	.49	.41
6MM	.58	.49
8MM	.71	.60
10MM	.85	.67
12MM	1.00	.79



### Composite PTC

TUBE SIZE	FULL INSERTION DEPTH (IN.)	MINIMUM O-RING DEPTH (IN.)
1/4"	.58	.47
3/8"	.70	.53
1/2"	.80	.61
5/8"	.99	.72
3/4"	1.04	.83

### PMTCE

TUBE SIZE	FULL INSERTION DEPTH (IN.)	MINIMUM O-RING DEPTH (IN.)
1/4"	.65	.54
3/8"	.81	.72
1/2"	.94	.72
5/8"	1.00	.75
3/4"	1.00	.75

### Brass PTC

TUBE SIZE	FULL INSERTION DEPTH (IN.)	MINIMUM O-RING DEPTH (IN.)
5/32"	.64	.44
3/16"	.62	.44
1/4"	.59	.49
3/8"	.78	.56
1/2"	.85	.63
5/8"	1.02	.80
3/4"	1.03	.82

### TrueSeal – Acetal & Kynar

TUBE SIZE	FULL INSERTION DEPTH (IN.)	MINIMUM O-RING DEPTH (IN.)
1/4"	.71	.52
5/16"	.80	.55
3/8"	.80	.55
1/2"	.90	.63

### TrueSeal - PolyPropylene

TUBE SIZE	FULL INSERTION DEPTH (IN.)	MINIMUM O-RING DEPTH (IN.)
1/4"	.74	.55
3/8"	.83	.59
1/2"	.93	.66

### Metric Prestomatic

TUBE SIZE	FULL INSERTION DEPTH (IN.)	MINIMUM O-RING DEPTH (IN.)
6MM	.78	
8MM	.80	
10MM	.91	
12MM	.91	
16MM	.89	

### LF3800 (PLS)

TUBE SIZE	FULL INSERTION DEPTH (IN.)	MINIMUM O-RING DEPTH (IN.)
1/4"	.69	.58
3/16"	.57	.49
3/8"	.90	.75
1/2"	.93	.78
4MM	.57	.49
6MM	.67	.56
8MM	.74	.65
10MM	.91	.76
12MM	.96	.79

### Prestomatic

TUBE SIZE	FULL INSERTION DEPTH (IN.)	MINIMUM O-RING DEPTH (IN.)
1/4"	.63	.54
3/8"	.81	.72
1/2"	.94	.72
5/8"	1.12	.75
3/4"	1.12	.92



# English/Metric Conversions

Inches x 25.4 = Millimeters (mm)  
 Inches x 2.54 = Centimeters (cm)  
 Inches x .254 = Decimeters (dm)  
 Feet x .3048 = Meters (m)  
 Yards x .9144 = Meters (m)  
 PSI x .0689 = Bars (bar)  
 Bars x 100 = Kilopascals (kPa)  
 PSI x .0069 = Megapascals (MPa)  
 Pound Inches x .113 = Newton Meters (N·m)

Pound Feet x 1.356 = Newton Meters (N·m)  
 Millimeters x .0394 = Inches  
 Centimeters x .3937 = Inches  
 Meters x 3.281 = Feet  
 Meters x 1.0936 = Yards  
 Bars x 14.5 = PSI Megapascals x 145 = PSI  
 Newton Meters x 8.85 = Pound Inches  
 Newton Meters x .737 = Pound Feet

## Millimeters to Fractions to Decimals

MM	INCHES	
	FRACTION	DECIMAL
.3969	1/64	.0156
.7938	1/32	.0312
1.1906	3/64	.0468
1.5875	1/16	.0625
1.9844	5/64	.0781
2.3812	3/32	.0937
2.7781	7/64	.1093
3.1750	1/8	.1250
3.5719	9/64	.1406
3.9688	5/32	.1562
4.3656	11/64	.1718
4.7625	3/16	.1875
5.1594	13/64	.2031
5.5562	7/32	.2187
5.9531	15/64	.2343
6.3500	1/4	.2500

MM	INCHES	
	FRACTION	DECIMAL
6.7469	17/64	.2656
7.1438	9/32	.2812
7.5406	19/64	.2968
7.9375	5/16	.3125
8.3344	21/64	.3281
8.7312	11/32	.3437
9.1281	23/64	.3593
9.5250	3/8	.3750
9.9219	25/64	.3906
10.3188	13/32	.4062
10.7156	27/64	.4218
11.1125	7/16	.4375
11.5094	29/64	.4531
11.9062	15/32	.4687
12.3031	31/64	.4843
12.7000	1/2	.5000

MM	INCH	
	FRACTION	DECIMAL
13.0969	33/64	.5156
13.4938	17/32	.5312
13.8906	35/61	.5468
14.2875	9/16	.5625
14.6844	37/64	.5781
15.0812	19/32	.5937
14.4781	39/64	.6093
15.8750	5/8	.6250
16.2719	41/64	.6406
16.6688	21/32	.6562
17.0656	43/64	.6718
17.4625	11/16	.6875
17.8594	45/64	.7031
18.2562	23/32	.7187
18.6531	47/64	.7343
19.0500	3/4	.7500

MM	INCH	
	FRACTION	DECIMAL
19.4469	49/64	.7656
19.8438	25/32	.7812
20.2406	51/64	.7968
20.2375	13/16	.8125
21.0344	53/64	.8281
21.4312	27/32	.8437
21.8281	55/64	.8593
22.2250	7/8	.8750
22.6219	57/64	.8906
23.0188	29/32	.9062
23.4156	59/64	.9218
23.8125	15/16	.9375
24.2094	61/64	.9531
24.6062	31/32	.9687
25.0031	63/64	.9843
25.4000	1	1.0000



# Assembly Guides

- A
- B
- C
- D
- E
- F
- G
- H
- I
- J
- K
- L
- M
- N
- O

## Push-to-Connect Fittings

- Prestolok PLP Metal
- Prestolok PLP Composite
- Prestolok PLM
- Prestolok PLS
- Oscillating Elbows
- LIQUIFit
- TrueSeal
- Flow Controls
- Prestomatic
- PTC
- Metric Prestomatic
- PMH
- Polypropylene Ball Valves

1. Cut tubing squarely – maximum of 15° angle allowable.
2. Check that port or mating part is clean and free of debris.
3. Mark tubing to appropriate tube insertion length. (see Tube Insertion Chart on page N22)
4. Insert tubing until it bottoms
5. Pull on tubing to verify it is fully inserted
6. To disassemble, simply press release button, hold against body and pull tubing out of fitting.



## Transportation Compression Style NTA

1. Cut tubing squarely – maximum of 15° angle allowable.
2. Check that port or mating part is clean and free of debris.
3. Insert tubing until it bottoms on seat.
4. Tighten nut with wrench until one thread remains visible on the fitting body; (this will allow for a number of remakes) or, the nut should be screwed down finger tight, then wrench-tightened as indicated in the following table.

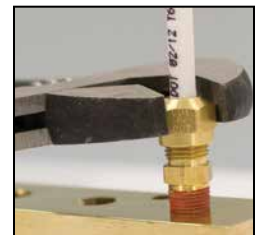

TUBE SIZE	ADDITIONAL NUMBER OF TURNS FROM HAND-TIGHT
3/16	2-1/2
1/4	3
3/8 & 1/2	4
5/8 & 3/4	3-1/2

## Air Brake – AB Fittings

1. Cut tubing squarely and remove burrs
2. Slide nut and sleeve onto tubing.
3. Insert tubing into fitting until bottomed on seat. The nut should be screwed down finger tight, then wrench tightened as indicated in the chart



TUBE SIZE	TURNS REQUIRED TO SEAL FROM HAND-TIGHT
1/4, 3/8, 1/2	2
5/8, 3/4	3

### Transmission Fittings

1. Cut tubing squarely and remove burrs
2. Insert tubing into fitting until bottomed
3. Tighten nut 1 1/2 turns from finger tight



### Air Brake Hose Ends

1. Slide nut onto hose
2. Slide sleeve onto hose with tapered edge toward fitting body
3. Bottom hose into fitting
4. Tighten nut until it contacts body hex



Note: When reassembling fitting, body and nut should be inspected. Only reuse if parts are in proper condition. Sleeves should never be Reused.

### Vibra-Lok

1. Cut the tubing squarely removing burrs
2. Slip nut and sleeve over tube
3. Bottom tubing into fitting and tighten nut until stop is reached. The elastic sleeve ordinarily will extrude slightly around the tube at the end of the nut. This extrusion further aids in isolating the tube from the nut.

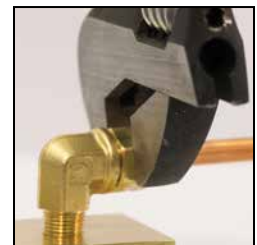

#### For Higher Pressure applications

4. Consult pressure chart to determine if tubing should be belled
5. Slip nut and sleeve over tube. The sleeve should be positioned near end of tubing just behind the surface to be belled
6. Bell tubing with standard 45° flaring tool or 90° punch. The size of bell should be approximately that shown.



#### Recommended Size of Bell

TUBE O.D.	BELL DIA. C
1/8	.190-.160
3/16	.255-.225
1/4	.318-.288
5/16	.381-.351
3/8	.444-.414
1/2	.569-.539
5/8	.694-.664
3/4	.819-.789
7/8	.944-.914

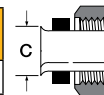

#### Tube Length Calculator

This table shows distance tube extends beyond face of Vibra-Lok fitting body on installation with bell on tubing and without bell on tubing.

O.D. OF TUBE	A WITH BELL	B WITHOUT BELL
1/8	3/16	3/16
3/16	3/16	7/32
1/4	3/16	1/4
5/16	3/16	1/4
3/8	3/16	1/4
1/2	3/16	11/32
5/8	3/16	TUBING SHOULD BE BELLED
3/4	3/16	
7/8	1/4	

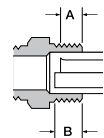

A

B

C

D

E

F

G

H

I

J

K

L

M

N

O

### Compression

1. Slide nut then sleeve onto tubing. The thread end of the nut must face out.
2. Insert tube and bottom on the fitting shoulder
3. Assemble nut to body and tighten “hand tight”. Then wrench tighten the number of turns indicated in the table.

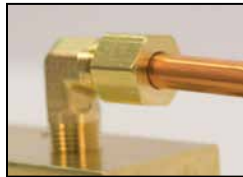

FITTING SIZE	TUBE SIZE	TURNS REQUIRED TO SEAL FROM HAND-TIGHT	
		60C WITH SOFT METAL TUBING	60PT WITH THERMOPLASTIC TUBING
2	1/8	1-1/4	--
3	3/16	1-1/4	--
4	1/4	1-1/4	2
5	5/16	1-1/4	2
6	3/8	2-1/4	2
8	1/2	2-1/4	2
10	5/8	2-1/4	2
12	3/4	2-1/4	2
14	7/8	2-1/4	--

### Compress-Align

With nut finger tight on fitting body, insert tubing until it bottoms in the Fitting. Complete the seal with one wrench turn for all sizes.



### Poly-Tite

1. Cut tubing squarely – maximum of 15° angle allowable.
2. Check that port or mating part is clean and free of debris.
3. Insert tube end until it bottoms in the Poly-Tite fitting and tighten knurl/hex nut finger-tight, plus one wrench turn.

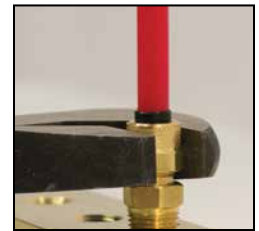

### Hi-Duty

1. Cut tube squarely and cleanly removing all burrs.
2. Grasp fitting. Do not remove nut.
3. Insert tube in fitting through nut until tube seats firmly against tube shoulder in body.
4. Grip tube firmly to prevent turning and tighten nut to finger-tight. Continue to tighten for one and three-quarter additional turns (one and one-half turns for 1/2” size fittings) for a positive, leak proof seal. During tightening a slight “give” will be felt. This “give” indicates the sleeve has been sheared from the nut. It is not necessary to tighten the nut all the way down.



### 45° Flare Fittings

1. Cut tubing squarely and clean tube end thoroughly to remove burrs.
2. Place nut onto tube. Place threaded end of nut toward end of tube.
3. Flare tube end with flaring tool to provide 45° flare.
4. Clamp tube flare between nut and nose of fitting body by screwing nut on finger-tight. Tighten with a wrench an additional 1/4 to 1/2 turn past finger-tight for a metal-to-metal seal.

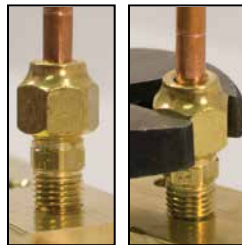

### Inverted Flare

1. Cut tubing squarely and clean to remove burrs
2. Place nut onto tube. Place threaded end of nut toward end of tube.
3. Flare tube end with flaring tool to provide 45° flare
4. On thin wall copper, welded or brazed tubing, use double flare to prevent pinch-off or cracked flares
5. Clamp tube flare between nut and nose of fitting body by screwing nut on finger tight. Tighten nut with a wrench an additional 1/4 to 1/2 turn past finger tight for a metal-to-metal seal.



### Dubl-Barb

Cut tube squarely and simply push tube over the two barbs



### Hose Barbs

1. Cut hose cleanly and squarely to length.
2. Slide clamp on hose.
3. Lubricate hose. Push hose on fitting until bottomed against stop ring or hex.
4. Position hose clamp as shown and secure with a screwdriver or wrench. Maintain "A" dimension for proper clamp positioning.



HOSE SIZE	HOSE CLAMP	A
3/16	97 HC-3	1/4
1/4	97 HC-3	1/4
5/16	97 HC-6	1/4
3/8	97 HC-6	1/8
1/2	97 HC-8	1/8
5/8	97 HC-12	1/8
3/4	97 HC-12	1/8

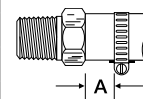

- A
- B
- C
- D
- E
- F
- G
- H
- I
- J
- K
- L
- M
- N
- O

- A
- B
- C
- D
- E
- F
- G
- H
- I
- J
- K
- L
- M
- N
- O

## Pipe Fittings

### Straight Fittings

1. Hand tighten external thread into internal thread
2. Tighten an additional 2 turns with a wrench up to 1/2" male pipe thread.
3. Above 1/2" 1 1/2 to 2 1/2 turns.

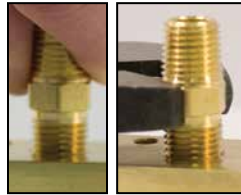

### Elbow or Tee Fittings

1. Hand tighten external thread into internal thread
2. Tighten an additional 1 to 1 1/2 turns with a wrench
3. Tighten fitting, clockwise to align with tubing. (Never counter clockwise)

Note: To minimize the possibility of a leaking threaded joint after assembling Male to female pipe threads, neither end should be backed out (loosened) Once the assembly has been made.

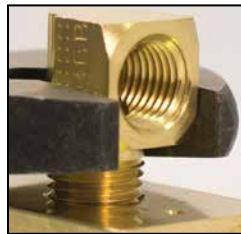
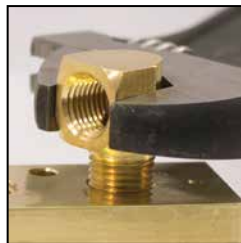

## Plug Valves

To assure sealability and reliable performance, the valve must be installed So that the flow media travels in the direction of the arrow on the valve handle.



## Needle Valves

Needle valves should always be installed with the pressure against the seat.

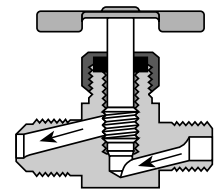

## NEMA Rated Bulkhead

1. Drill panel to required diameter
2. Install sealing washer onto brass body.
3. Install fitting body through panel and secure with lock washer and jam nut.
4. Using a wrench to hold the fitting body torque the jam nut to spec per below table.

Note: For sealing bulkheads the sealing washer must be installed between the body hex and panel. To ensure a leak tight connection the panel surface must be kept flat and deburred after the drilling operation. It must be free from dirt, debris, and other contamination.

THREAD SIZE	MIN. TORQUE FT-LBS	MAX. TORQUE FT-LBS
5/8-18	15	20
3/4-16	15	25
1-14	40	50



# Fluid Compatibility Guide

The following pages list general recommendations for the selection of valve materials. For specific cases, and for those not included in the Fluid Compatibility Chart, it is advisable to check with your Parker representative.

There are many specific environmental factors which might affect corrosion rate such as temperature, solution, concentration and presence of impurities. Therefore, we suggest that the information be used as a rough guide to material selection. If any questions exist regarding the expected performance of a material in a given application, actual tests should be performed to determine the suitability of the materials in question.

FLUID	BRASS	CARBON STEEL	216 S.S.	BUNA N (NITRILE)	NEO-PRENE	EPR	FLUORO-CARBON	PTFE	ACETAL	NYLON
ACETALDEHYDE	P	G	E	P	G	G	P	E	U	
ACETAMINE	G	G	G	E	G			E		
ACETATE SOLVENTS	E	E	E	P			U	E	U	
ACETIC ACID VAPORS	U		U	U				E		
ACETIC ACID (10%)	P	P	E	U	P	G	U	E	U	U
ACETIC ACID (80%)	P	P	E	U	U	P	U	E	U	U
ACETIC ACID (AERATED)	P	P	E	G	G		P	E	U	
ACETIC ACID (AIR FREE)	P	P	E	G	G		U	E	U	
ACETIC ACID (CRUDE)	P	P	E	U	U		U	E	U	
ACETIC ACID (GLACIAL)			U	U	P	G	P	E		U
ACETIC ACID (PURE)	P	U	E	U	U		U	E	U	
ACETIC ANHYDRIDE	U	U	G	U	P	P	U	E	U	U
ACETONE	E	E	E	U	U	E	U	E	E	E
ACETOPHENONE	G	G	G	U	U	E	U			
ACETYL CHLORIDE	E	G	P	U	U	U	U	E		
ACETYLENE	G	E	E	G	P	E	E	E	E	
ACID FUMES	U	U	G	P	G			E		
ACRYLONITE	E	E	E	U	U	U	P	E		
AIR	E	E	E	E	E	E	E	E	E	
ALCOHOL, AMYL	G	G	E	P	P	E	G	E	E	
ALCOHOL, BUTYL	G	G	E	G	G	P	E	E	E	
ALCOHOL, DIACETONE	E	E	E	U	P	G	U	E		
ALCOHOL, ETHYL	G	G	G	E	G	E	E	E	E	
ALCOHOL, ISOPROPYL	G	G	G	P	G	E	E	E	E	
ALCOHOL, METHYL	E	G	E	G	E	E	P	E	E	
ALCOHOL, PROPYL	E	G	E	G	G	E	E	E		
ALCOHOLS, FATTY	G	G	E	G	G			E		
ALUM	U		G	G	G		G	E		
ALUMINA	U		E	E	E	E		E		
ALUMINUM ACETATE	G		E	U	U	E	U	E		
ALUMINUM BROMIDE				E	E	E	E			
ALUMINUM CHLORIDE DRY	U	P	P	G	G	E	E	E	E	
ALUMINUM CHLORIDE SOLUTION			U	G	G		E	E		U
ALUMINUM FLUORIDE	U	U	P	E	E	E	E	E		U
ALUMINUM HYDROXIDE	E	U	E	E	E	E	E	E		
ALUMINUM NITRATE	U	U	P	G	G	G	U	E		
ALUMINUM OXALATE			U					E		
ALUMINUM SALTS				E	E	E	E			
ALUMINUM SULFATE	P	U	G	E	E	E	E	E	E	P
AMINES	G	G	E	U	U	P	U	E	E	

E-EXCELLENT

G-GOOD

P-POOR

U-UNSATISFACTORY



A  
B  
C  
D  
E  
F  
G  
H  
I  
J  
K  
L  
M  
N  
O

FLUID	BRASS	CARBON STEEL	216 S.S.	BUNA N (NITRILE)	NEO-PRENE	EPR	FLUORO-CARBON	PTFE	ACETAL	NYLON
AMYLCHLORIDE	G		E	U	P	U	U	E		
AMMONIUM BICARBONATE	G	P	G	G	E	E	E	E	E	
AMMONIA, ALUM			E	G	G			E		
AMMONIA, ANHYDROUS LIQUID	U	E	E	G	P	G	U	E		
AMMONIA, AQUEOUS	U	E	E	G	G		E	E		
AMMONIA, GAS, HOT	U	G	E	P	E	E	U	E		
AMMONIA LIQUOR			E					E		
AMMONIA SOLUTIONS	U	G	E	G	G	G	U	E		
AMMONIUM ACETATE	U		G	G	G	E	U	E		
AMMONIUM BROMIDE 5%			G					E		
AMMONIUM CARBONATE	G	G	G	P	E	E	G	E	E	
AMMONIUM CHLORIDE	U	U	P	G	E	E	E	E	E	U
AMMONIUM HYDROXIDE 28%	U	P	G	G	E	G	E	E		
AMMONIUM HYDROXIDE CONC.	U	P	G	P	E	E	E	E	E	
AMMONIUM MONOSULFATE			E					E		
AMMONIUM NITRATE	U	U	E	E	E	E	E	E	E	U
AMMONIUM OXALATE 5%			E					E		
AMMONIUM PERSULFATE	P	U	E	U	P	G	G	E		U
AMMONIUM PHOSPHATE	U	U	G	E	E	E	E	E	G	P
AMMONIUM PHOSPHATE DI-BASIC	P	U	G	E	E		E	E	E	
AMMONIUM PHOSPHATE TRI-BASIC	P	U	G	E	E		E	E	E	
AMMONIUM SULFATE	P	P	G	E	E	E	G	E	E	U
AMMONIUM SULFIDE	U	U	G	E	G	E	U	E		
AMMONIUM SULFITE	P	P	E	G	E	G	E	E	E	
AMYL ACETATE	G	P	G	U	U	G	U	E	G	P
AMYL BORATE				E	E	U	E			
AMYL CHLORONAPHTHALENE				U	U	U	E			
AMYL NAPHTHALENE				U	U	U	E			
ANILINE	U	P	G	U	U	P	P	E	E	P
ANILINE DYES	P	P	E	P	P	P	G	E	E	
ANIMAL OIL	G	G	G	E	G	G	E			
ANTIMONY TRICHLORIDE	U	U	U	P			G	E		
APPLE JUICE	P	U	G	E	E	G	E	E		
AQUA REGIA (STRONG ACID)	U	U	G	U	U	U	U	E		U
AROCLOR 1248	G	U	U	U	U	G	E			
AROCLOR 1254	G	U	U	U	U	G	E			
AROCLOR 1260	G	U	U	E	E		E			
AROMATIC SOLVENTS	E	P	E	U	U	U		E		
ARSENIC ACID	U	U	G	E	E	G	E	E	E	U
ASPHALT EMULSION	E	G	E	U	P	U	E	E	E	
ASPHALT LIQUID	E	G	E	P	P	U	E	E	E	
ASTM OIL, NO. 1	E	E	E	E	E	U	E			
ASTM OIL, NO. 2	E	E	E	E	E	G	U	E		
ASTM OIL, NO. 3	E	E	E	E	U	U	E			
ASTM OIL, NO. 4	E	E	E	G	U	U	E			
ASTM REFERENCE FUEL A	U	G	E	E	G	U	E			
ASTM REFERENCE FUEL B	U	G	E	E	U	U	E			
ASTM REFERENCE FUEL C	U	G	E	G	U	U	E			
BARIUM CARBONATE	G	G	G	G	E	E	E	E	E	
BARIUM CHLORIDE	G	P	G	E	E	E	E	E	E	E
BARIUM CYANIDE	P		G	G	G	G	G	E		
BARIUM HYDRATE	U		E					E		
BARIUM HYDROXIDE	P	P	G	E	E	G	E	E	E	
BARIUM NITRATE			E		G			E		
BARIUM SALTS				E	E	E	E			

E-EXCELLENT

G-GOOD

P-POOR

U-UNSATISFACTORY



FLUID	BRASS	CARBON STEEL	216 S.S.	BUNA N (NITRILE)	NEO-PRENE	EPR	FLUORO-CARBON	PTFE	ACETAL	NYLON
BARIUM SULFATE	P	P	E	E	E	G	E	E	E	E
BARIUM SULFIDE	U	P	G	E	G	E	E	E	E	
BEER	G	U	E	G	G	G	E	E	E	U
BEET SUGAR LIQUORS	E	G	E	E	E	G	E	E	E	
BENZALDEHYDE	E	E	E	U	U	E	U	E	E	E
BENZENE	G	G	G	U	U	U	G	E		E
BENZENESULFONIC ACID, 10%	U	U	U	U	G	U	E			
BENZYLCHLORIDE	U	U	G	U	U	U	E			
BENZOIC ACID	G	U	G	P	P	U	G	E		P
BENZYL ALCOHOL		U	E	U	G	G	E			
BERYLLIUM	G		G	G	G	G	G	E		
BLEACH LIQUOR				U	G	E	E			
BLEACHING POWDER WET	G		P	U	E	G	G	E		
BLOOD	G		E	G	G	G	G	E		
BORAX	U	P	E	G	U	E	E	E	E	E
BORAX LIQUORS	E	P	G		P	E	E	E	E	
BORDEAUX MIXTURE			E					E		
BORIC ACID	P	U	G	G	G	G	E	E	E	G
BRAKE FLUID	G		G	U	P	G	U	E		
BRINES, SATURATED	G	U	G	E	G	E	E	E	E	
BROMINE, DRY	G	U	U	U	U	U	G	E		
BROMINE, WET	U	U	U	U	U		G	E		
BUNKER OILS (FUEL)	G	G	E	G	G		E	E	E	
BUTADIENE	P	G	E	P	P	P	G	U		
BUTANE	E	G	E	G	G	U	E	E	E	
BUTTER	G	U	E	G	G			E		
BUTTERMILK	U	U	E	E	E	G	E	E	E	
BUTYLACETATE	G		G	U	U	U	U	E		E
BUTYL ALCOHOL	E	P	E	G	G		G	E		
BUTYL AMINE	G	G	E	U	U		U	E		
BUTYL BUTYRATE				U	U	E	E			
BUTYL CARBITOL	E	P	E	U	U		U	E		
BUTYL CELLOSOLVE	E	P	E	U	U		G	E		
BUTYL STEARATE				G	U	U	E			
BUTYLENE	E	E	E	U	U	U	U	E		
BUTYRIC ACID	P	U	G	P	P	P	P	E	E	U
CALCINE LIQUORS				E		E	E			
CALCIUM ACETATE				G	G	E	U			
CALCIUM BISULFITE	P	U	G	E	E	U	E	E	E	
CALCIUM CARBONATE	P	U	G	E	E	G	E	E	E	
CALCIUM CHLORATE	U		G	G	G	G	G	E		
CALCIUM CHLORIDE	G	P	G	E	E	G	E	E	E	U
CALCIUM HYDROXIDE	P	P	G	E	G	E	E	E	E	
CALCIUM HYPOCHLORITE	U	U	P	P	P		E	E		U
CALCIUM NITRATE			G	G	G	G		E		
CALCIUM PHOSPHATE	P		G	G	G	G	G	E		
CALCIUM SALTS				E	E	E	E			
CALCIUM SILICATE	P		G	G	G	G	G	E		
CALCIUM SULFATE	P	P	G	E	E	G	E	E	E	U
CALCIUM SULFIDE	U	U	G	E	E	E	E			
CALICHE LIQUOR		G	E	G	G			E		
CAMPHOR	P		G	G	G	G	G	E		
CANE SUGAR LIQUORS	G	G	E	G	G	G	G	E		
CARBOLIC ACID	U	U	G	G	G	G	E	E	U	
CARBON BISULFIDE	P	G	G	U	U	U	E	E	E	

E-EXCELLENT

G-GOOD

P-POOR

U-UNSATISFACTORY



A  
B  
C  
D  
E  
F  
G  
H  
I  
J  
K  
L  
M  
N  
O

FLUID	BRASS	CARBON STEEL	216 S.S.	BUNA N (NITRILE)	NEO-PRENE	EPR	FLUORO-CARBON	PTFE	ACETAL	NYLON
CARBON DIOXIDE, DRY	E	E	E	P	G	G	G	E		
CARBON DISULFIDE	U	P	E	U	U		E	E		
CARBON MONOXIDE	E	E	E	G	U	G	G	E		
CARBON TETRACHLORIDE, DRY	P	G	E	U	U	U	G	E	E	
CARBON TETRACHLORIDE, WET	U	U	G	U	U	U	G	E	E	
CARBONATED BEVERAGE	G	U	G	G	G	G	G	G	E	
CARBONATED WATER	G	G	E	E	E	E	E	E	E	
CASEIN	P			G	G	G	G	G	E	
CASTER OIL	E	G	E	E	G	G	E	E	E	
CAUSTIC POTASH			E	G	G			E		
CAUSTIC SODA		G	E	P		G	G	E		
CELLULOSE ACETATE	G		G	U	U	G	U	E		
CELLULUBE	E	P	E	U	U		U	E		
CHINA WOOD OIL	P	P	E	E	G	U	E	E	E	
CHLORACETIC ACID	P	U	U	U	P		P	E		U
CHLORINATED SOLVENTS	P	P	E	U	U	U	P	E	E	
CHLORINATED WATER	U	P	G	E		E	E	E	U	U
CHLORINE, WET	U	U	U	U	U			E		
CHLORINE GAS	P	G	G	P	U	U	G	E	E	
CHLORO BROMO METHANE	G	U	G	U	U		G	E		
CHLOROBENZENE, DRY	G	G	E	U	U	U	E	E	E	E
CHLOROBUTADIENE				U	U	U	E			
CHLOROFORM, DRY	G	G	E	U	U	U	G	E	E	U
CHLOROPHYLL, DRY	G		G	G	G	G	G	E		
CHLOROSULFONIC ACID, DRY	P	G	G	U	U	U	U	E		U
CHLOROSULFONIC ACID, WET	U	U	U	U	U		P	E		
CHLORPHENOL				U	U	U	E			
CHROME ALUM	P	G	E	G	G	G	G	E		
CHROMIC ACID <50%	U	U	P	U	U	P	P	E	U	U
CHROMIC ACID >50%	U	U	P	U	U	P	P	E	U	
CHROMIUM SULFATE	P		G	G	G	G	G	E		
CIDER			E					E		
CITRIC ACID	P	U	G	G	E	G	E	E		P
CITRUS JUICES	G	U	G	E	E		E	E	E	
COCA-COLA SYRUP			E	G	G		G	E		
COCONUT OIL	G	P	G	E	P	E	E	E	E	
COFFEE	E		E	E	E	E	E	G		
COFFEE EXTRACTS, HOT	G	P	E					E		
COKE OVEN GAS	P	G	E	P	U	U	G	E		
COOKING OIL	G	G	E	E	G	U	E	E	E	
COPPER ACETATE	U	U	E	P	P	G	U	E		
COPPER CARBONATE			E					E		
COPPER CHLORIDE	U	U	P	G	G		E	E		U
COPPER CYANIDE	U		E	E	E	G	G	E		E
COPPER NITRATE	U	U	G	E	E	G	E	E	E	U
COPPER SALTS					E	E	E	E		
COPPER SULFATE	U	U	G	E	E	E	E	E	E	P
CORN OIL	G	P	G	E	P	P	E	E	E	
COTTONSEED OIL	G	P	G	E	G	P	G	E	E	
CREOSOTE OIL	G	G	G	P	U	U	E	E	U	
CREOSOLS	U	G	G	U	U	U	U	E		
CRESYLIC ACID	P	P	G	U	U	U	G	E	U	U
CRUDE OIL, SOUR	P	G	E	E	G	U	E	E		
CRUDE OIL, SWEET	G	G	E	E	G		E	E		
CUPRIC NITRATE			E					E		

E-EXCELLENT

G-GOOD

P-POOR

U-UNSATISFACTORY



FLUID	BRASS	CARBON STEEL	216 S.S.	BUNA N (NITRILE)	NEO-PRENE	EPR	FLUORO-CARBON	PTFE	ACETAL	NYLON
CUTTING OILS,	E	G	E	E	G		E	E	E	
WATER EMULSIONS										
CYANIDE PLATING SOLUTION	U		G	G	G	G	G	E		
CYCLOHEXANE	E	E	E	P	U	U	E	E	E	
CYCLOHEXANONE	G		E	U	U			E		
DECANE				E	U	U	E			
DENATURED ALCOHOL				E	E	E	E			
DETERGENTS, SYNTHETIC	G	U	G	G	G	G	E	E		
DEXTRIN	G		G	G	G	G	G	E		
DIACETONE ALCOHOL	E	E	E	U	P			E		
DICHLOROETHANE			P	U	U	U		E		
DICHLOROETHYL ETHER	G		G	U	U	U	U	E		
DIESEL OIL FUELS	E	E	E	E	P	U	E	E		
DIETHYL BENZENE			G	U	U	U		E		
DIETHYL SULFATE	G		G	P	P	P	G	E		
DIETHYLAMINE	G	E	E	G	P	P	U	E		
DIETHYLENE GLYCOL	G	E	E	E	E	E	G	E		
DIMETHYL FORMAMIDE	G		E	G	U	U	U	E		
DIMETHYL PHTHALATE			U	G	G		U	E		
DIOCTYL PHTHALATE	E		E	P	U		P	E		
DIOXANE	G		G	U	U	P	U	E		
DIPENTANE	E		E	G	U	U	G	E		
DISODIUM PHOSPHATE			G	G	G		G	E		
DOW CHEMICAL HD50-4					G	E	U			
DOW CORNING 200, 510, 550				G	E	E	E			
DOWTHERM	E	G	E	U	U	U	E	E	E	
DRILLING MUD	G	G	E	E	P	E	E	E	E	
DRY CLEANING FLUIDS	P	G	E	U	U		G	E	E	
DRYING OIL	P	P	G	E	G			E	E	
ENAMEL	E		E	G	G	U		E		
EPSOM SALTS	G	P	G	E	E		E	E	E	
ETHANE	G	P	G	E	G	U	E	E	E	
ETHANOL	E	U	U	U	E	E	U			
ETHANOLAMINE	U	G	E	G	P		U	E		
ETHERS	G	E	E	U	U	P	P	E	P	
ETHYL ACETATE	P	G	G	U	U	P	U	E	E	E
ETHYL ACRYLATE	G	P	E	U	U	P	U	E		
ETHYL ALCOHOL	G	G	G	E	E		E	E		
ETHYL BENZENE			G	P	U	U		E	E	
ETHYL BROMIDE	E		G	G	G	G	G	E		
ETHYL CHLORIDE, DRY	G	G	E	P	P	P	G	G	E	E
ETHYL CHLORIDE, WET	P	U	G	P	P	G	G	E		
ETHYL ETHER	G		E	U	U	U	U	E		
ETHYL HEXANOL				E	E	E	E			
ETHYL SILICATE	G		G	G	P	G	G	E		
ETHYL SULFATE			G	G	G	P	E	E	E	
ETHYLENE CHLORIDE			E	U	E		U	E		
ETHYLENE DICHLORIDE	U	U	G	U	U	U	U	E		
ETHYLENE GLYCOL	G	G	G	E	G	E	E	E		
ETHYLENE OXIDE	P	G	G	U	U	U	U	E		
FATTY ACIDS	P	U	E	G	G	U	E	E	E	U
FERRIC CHLORIDE	U	U	U	E	U		E	E		U
FERRIC HYDROXIDE			E	G				E		
FERRIC NITRATE	U	U	P	E	E	E	E	E	E	U
FERRIC SULFATE	U	U	G	E	E	E	E	E	E	U

E-EXCELLENT

G-GOOD

P-POOR

U-UNSATISFACTORY



A  
B  
C  
D  
E  
F  
G  
H  
I  
J  
K  
L  
M  
N  
O

FLUID	BRASS	CARBON STEEL	216 S.S.	BUNA N (NITRILE)	NEO-PRENE	EPR	FLUORO-CARBON	PTFE	ACETAL	NYLON
FERROUS AMMONIUM CITRATE			G					E		
FERROUS CHLORIDE	G	U	U	E	E	E	E	E	E	U
FERROUS SULFATE	G	U	G	E	E	E	E	E	E	U
FERROUS SULFATE, SATURATED	P	P	E	P	P	G	G	E		
FERTILIZER SOLUTIONS	P	G	G	G	G			E	G	
FISH OILS	G	G	E	E	G	U	E	E	G	
FLUE GASES	G		E	P	P	U	P	E	P	
FLUOBORIC ACID			G	E	G			E		U
FLUOROSILICIC ACID	G	U	G	P	P	P	P	E		U
FLUORINE, DRY	U		U	U					E	
FOOD FLUIDS & PASTES	G	P	E	G	E			E		
FORMALDEHYDE, COLD	E	E	E	G	P	G	U	E	E	U
FORMALDEHYDE, HOT	G	U	P	G	G			E	E	U
FORMIC ACID, COLD	G	U	G	U	G		G	E	U	E
FORMIC ACID, HOT	G	U	G	U	E		E	E	U	
FRUIT JUICES	G	U	E	E	E	E	E	E	E	
FUEL OIL	G	G	E	E	P	U	E	E	E	
FUMARIC ACID				G	G			E		
FURFURAL	E	E	E	U	P	P	U	E	E	E
GALIC ACID 5%	P	U	G	G	G	P	E	E	E	
GAS, NATURAL	G	G	E	E	E	U	E	E	E	
GAS, ODORIZERS	E	G	G	G	G		E	E	E	
GAS MFG.	G	G	G	E			E	E	E	
GASOLINE, AVIATION	E	E	E	P	U		E	E	E	
GASOLINE, LEADED	E	E	E	P	U		E	E	E	
GASOLINE, MOTOR	E	E	E	P	U	U	E	E	E	
GASOLINE, REFINED	G	G	E	P	P	U	E	E		
GASOLINE, SOUR	G	G	E	P	U	U	E	E	E	
GASOLINE, UNLEADED	E	E	E	P	U		E	E	E	E
GELATIN	E	U	E	E	E	E	E	E	E	
GLUCOSE	E	G	E	E	E	E	E	E	E	
GLUG	E	G	E	E	G	E	E			
GLYCERINE	G	P	E	P	U	E	G	E	P	E
GLYCOL	G	P	G	G	E	E	E	E	P	
GLYCOL AMINE	U		G	E		U	U			
GRAPHITE	G		G	G	G	G	G	E		
GREASE	P	E	E	E	G	U	E	E		
GULF-FR FLUID, EMULSION				E	G	U	E			
GULF-FR FLUID G				E	E	E	E			
GULF-FR FLUID P				U	U	G	G			
HELIUM GAS	G	E	E	G	G	G	G	E		
HEPTANE	E	G	E	E	G	U	E	E	E	
HEXANE	G	G	E	E	P	U	E	E	E	E
HEXANOL, TERTIARY	E	E	E	E	P	U	G	E		
HEXYL ALCOHOL	E	P	E	U	P		E	E		
HYDRAULIC OIL, PETROLEUM BASE	G	E	E	E	G	U	E	E	E	
HYDRAZINE	U	U	G	P	P	G	U	E		
HYDRIGEN SULFIDE, DRY	P	G	E	P	E	E	E	E		
HYDROCHLORIC ACID, AIR FREE	U	U	U	G	P		E	E		U
HYDROCYANIC ACID	U	U	E	G	G	G	E	E	U	
HYDROFLUORIC ACID	U	U	U		G					U
HYDROFLUOSILICIC ACID	E	U	P	G	G	G	E	E		U
HYDROGEN GAS, COLD	G	G	E	G	G	G	E	E		
HYDROGEN GAS, HOT	G	G	G	G	G		E			
HYDROGEN PEROXIDE,	U	U	G	U	U	G	G	E		U

E-EXCELLENT

G-GOOD

P-POOR

U-UNSATISFACTORY



FLUID	BRASS	CARBON STEEL	216 S.S.	BUNA N (NITRILE)	NEO-PRENE	EPR	FLUORO-CARBON	PTFE	ACETAL	NYLON
CONCENTRATED										
HYDROGEN PEROXIDE, DILUTE	P	U	G	E	G	G	E	E	G	U
HYDROGEN SULFIDE, WET	U	P	G	P	G	G	E	E	E	
HYDROLUBE				E	G	E	E			
HYPO (SODIUM THIOSULFATE)	P	U	G	E	E	E	E	E	E	
HYPOCHLORITES, SODIUM	U	U	P	P			E	E		
ILLUMINATING GAS	E	E	E	P	P	U	E	E		
INK, NEWSPRINT	P	U	E	E	G	G	E	E	E	
IODINE, WET	U	U	U	G			E	E		
IODOFORM	P	G	E				E	E	E	
ISOPROPYL ACETATE			G	U	U	U		E		
ISOPROPYL ALCOHOL	G	G	G	P	G		E	E		
ISOPROPYL ETHER	E	E	E	P	P	U	U	E		
ISO-BUTANE			G	G	U	U		E		
ISO-OCTANE	E	E	E	E	P	U	E	E	E	
J P-4 FUEL	E	E	E	E	P		E	E	E	
J P-5 FUEL	E	E	E	G	P		E	E	E	
J P-6 FUEL	E	E	E	E	P		E	E	E	
KEROSENE	E	G	E	E	P	U	E	E	E	
KETCHUP	U	U	E	E	E		E	E	E	
KETONES	E	E	E	U	U	U	U	E	E	
LACTIC ACID, CONC. COLD	U	U	E	G	E	G	E	E	U	U
LACTIC ACID, CONC. HOT	U	U	G	P	P	G	G	E	U	U
LACTIC ACID, DILUTE COLD	U	U	E	G	E	G	E	E	U	U
LACTIC ACID, DILUTE HOT	U	U	E	P	U		U	E	U	U
LACTOSE	G		G	G	P	G	G	E		
LAQUER	E	P	E	U	U	U	U	E	E	E
LARD	G	E	E	G	P	P		E		
LARD OIL	G	P	G	E	G	G	E	E	E	
LEAD ACETATE	P	U	G	E	G	G	G	E	E	E
LEAD SULFATE	P		G	G	G	G	G	E		
LECITHIN	P		G	U	U	U	G	E		
LINOLEIC ACID	G	G	E	G	G	U	G	E	E	
LINSEED OIL	G	E	E	E	P	U	E	E	E	
LITHIUM CHLORIDE	G		G	G	G	G	G	E		
LPG	E	G	G	E	G	U	E	E	E	
LUBRICATING OIL	G	E	E	E	G	U	E	E	E	
LUDOX	U		G	G	G	G	G	E		
MAGNESIUM BISULFATE	G	G	E	G	G	G	G	E		
MAGNESIUM BISULFIDE	U		G	G	G	G	G	E		
MAGNESIUM CARBONATE	G		E	G	G	G	G	E		
MAGNESIUM CHLORIDE	G	P	G	E	E	E	E	E	E	E
MAGNESIUM HYDROXIDE	G	G	E	E	E	E	E	E	E	
MAGNESIUM HYDROXIDE HOT	U	G	E	G	G		E	E	E	
MAGNESIUM NITRATE			E	G	E		G	E		E
MAGNESIUM SALTS				E	E	E	E			
MAGNESIUM SULFATE	G	G	E	E	E	E	E	E	E	E
MALEIC ACID	G	G	G	G	G	U	E	E	E	
MALEIC ANHYDRIDE	G		G	U	U	U	G	E		
MALIC ACID	G	U	G	E	G		E	E	E	
MALT BEVERAGES			E	E	E	G	E	E		
MANGANESE CARBONATE			G	G				E		
MANGANESE SULFATE	G		E	G	G	G	G	E		
MAYONNAISE	U	U	E	E	E		E	E	E	
MEAT JUICES	U		E	G	G			E		

E-EXCELLENT

G-GOOD

P-POOR

U-UNSATISFACTORY



A  
B  
C  
D  
E  
F  
G  
H  
I  
J  
K  
L  
M  
N  
O

FLUID	BRASS	CARBON STEEL	216 S.S.	BUNA N (NITRILE)	NEO-PRENE	EPR	FLUORO-CARBON	PTFE	ACETAL	NYLON
MELAMINE RESINS			P	G	G			E		
MERCURIC CHLORIDE	U	U	G	E	G	E	E	E		
MERCURIC CYANIDE	U	U	E	E	G	E	E	E		
MERCUROUS NITRATE	U		E				G	E		
MERCURY	U	E	E	E	E	E	E	E	E	
METHANE	E	G	E	E	G		E	E	E	
METHANOL	E	E		E	E	E	U			
METHANOL	G		E	G	G	U	G	E		
METHYL ACETATE	E	G	E	U	U	G	U	E		
METHYL ACETONE	E	E	E	U	U	E	U	E		
METHYL ALCOHOL	G	G	G	E	G		P	E		E
METHYL BROMIDE 100%	P	G	G	G	U	U	G	E		
METHYL CELLOSOLVE	E	G	E	P	U	G	U	E		
METHYL CELLULOSE			E	U	U			E		
METHYL CHLORIDE	G	G	E	U	U	U	G	E	E	
METHYL ETHER				E	U	U	E			
METHYL ETHYL KETONE	E	E	E	U	U	G	U	E	E	E
METHYL FORMATE	E	P	G	U	G	G	U	E		
METHYL ISOBUTYLE KETONE			E	U	U			E		
METHYLAMINE	U	G	E	U	U	G	U	E		
METHYLENE CHLORIDE	E	G	E	U	U	U	P	E		U
MILK & MILK PRODUCTS	G	U	E	E	E	E	E	E	E	
MIL-F-81912, JP-9	E	E	E	U	U	U	E			
MIL-H-5606	E	E	E	E	G	U	E			
MIL-H-6083	E	E	E	E	E	U	E			
MIL-H-7083	E	E	E	E	G	E	G			
MIL-H-8446	G	E	E	G	E	U	E			
MIL-L-2104 & 2104B	E	E	E	E	G	U	E			
MIL-L-7808	U	G	E	G	U	U	E			
MINE WATERS, ACID	P	U	P	E			E	E		
MINERAL OILS	G	G	E	E	G	U	E	E	E	
MINERAL SPIRITS	G	G	G	E	P		E	E	E	
MIXED ACIDS, COLD	U	P	G	U	U	U	G	E	U	
MLO-7277 & MLO-7557	G	E	E	U	U	U	E			
MOBILE HF	E	E	E	E	G	U	E			
MOLASSES, CRUDE	E	E	E	E	E		E	E	E	
MOLASSES, EDIBLE	E	P	E	E	E		E	E	E	
MOLYBDIC ACID			E					E		
MONOCHLORO BENZENE DRY			G	U	U			E		
MONOMETHYL HYDRAZINE				G	G	E				
MORPHOLINE	G		E	U	U	G	U	E		
MURIATIC ACID	U	U	U	G			E	E		
MUSTARD	E	G	E	E	E		E	E	E	
NAPHTHENIC ACID	G	E	G	G	U	U	E			
NAPHTHA	G	G	G	G	P	U	E	E	E	
NAPHTHALENE	G	G	G	U	U	U	E	E	E	
NATURAL GAS, SOUR	G	G	E	E	E	U	E	E		
NEATSFOOT OIL				E	U	G	E			
NICKEL ACETATE	U	G	E	G	G	E	U			
NICKEL AMMONIUM SULFATE	U	U	E	E	G	G	U	E		
NICKEL CHLORIDE	U	U	G	E	E	G	E	E	E	E
NICKEL NITRATE	U	U	G	E	E	E	E	E	E	
NICKEL SALTS				E	G	E	E			
NICKEL SULFATE	U	U	G	E	E	G	E	E	E	E
NITRIC ACID 100%	U	U	E	U	U	U	G	E	U	U

E-EXCELLENT

G-GOOD

P-POOR

U-UNSATISFACTORY





FLUID	BRASS	CARBON STEEL	216 S.S.	BUNA N (NITRILE)	NEO-PRENE	EPR	FLUORO-CARBON	PTFE	ACETAL	NYLON
NITRIC ACID 10%	U	U	E	P	G		E	E	U	U
NITRIC ACID 30%	U	U	E	P	P	G	E	E	U	U
NITRIC ACID 80%	U	U	P	U	U	U	G	E	U	U
NITRIC ACID ANHYDROUS	U	U	E	U	U	U	E	E		
NITROBENZENE	U	G	E	U	U	P	P	E		E
NITROGEN	E	E	E	E	E	G	E	E	E	
NITROUS ACID 10%	U	U	G	P	E		E	E		
NITROUS GASES	U	G	E					E		
NITROUS OXIDE	G	G	G	G	G		E	E		
NOCOTINIC ACID	E	G	E	U	U	U	G	E		
OCTYL ALCOHOL	E	E	E	G	G	U	E			
OILS, ANIMAL	E	E	E	E	G	G	G	E		
OILS, PETROLEUM REFINED	G	E	E	E	G	U	E	E	E	
OILS, PETROLEUM SOUR	P	G	E	G	G	U	E	E		
OILS, WATER MIXTURE	E	G	E	E	G		E	E	E	
OILS & FATS			E	G		U		E		
OLAIC ACID			G	U	U		P	E		
OLEIC ACID	G	P	G	G	P	U	E	E	E	
OLEUM	P	G	G	U	U	U	P	E	U	
OLEUM SPIRITS	U		G	P	U	U	E	E		
OLIVE OIL	P	G	E	E	G	G	E	E	E	
ORTHO-DICHLOROBENZENE	G	G	G	U	U	U	E			
OTHER KETONES	E	E	E	U	U	U	U	E		
OXALIC ACID	G	U	G	P	G	G	E	E	P	U
OXYGEN	E	G	E	G	G	E	E	E	U	
OZONE, DRY	E	E	E	U	U	E	G	E		
OZONE, WET	G	P	E	U	U	G	G	E		
PAINTS & SOLVENTS	E	E	E	U	U	U	G	E		
PALM OIL	G	P	G	G	G	U	E	E	E	
PALMITIC ACID	G	P	G	G	G	G	E	E	E	
PAPER PULP	G		E	G	G	G	G	E		
PARAFFIN	E	G	E	E	P	U	E	E	E	
PARAFORMALDEHYDE	G	G	G	G	G	U		E	E	
PARALDEHYDE			G	G	G	U		E		
PARA-DICHLOROBENZENE	G	E	E	U	U	U	E			
PARKER O LUBE	E	E	E	E	E	U	E			
PEANUT OIL	G	E	E	E	U	U	E			
PENTANE	E	G	E	E	G	U	E	E	E	
PERCHLORETHYLENE, DRY	P	G	E	U	U	U	E	E		
PERCHLORIC ACID-2N	U	U	G	U	G	G	E			
PETROLATUM (PETROLEUM JELLY)	G	P	G	E	G		E	E	E	
PHENOL	G	U	E	U	U	U	G	E	U	E
PHOSPHATE ESTER	U	E	E	U		E		E		
PHOSPHORIC ACID 10%	U	U	U	G	E	G	E	E	U	U
PHOSPHORIC ACID 50% COLD	U	U	G	G	G	G	E	E	U	U
PHOSPHORIC ACID 50% HOT	U	U	U	G	G	G	E	E	U	U
PHOSPHORIC ACID 85% COLD	G	G	E	P	P		G	E	U	U
PHOSPHORIC ACID 85% HOT	P	P	G	P	P			E	U	U
PHOSPHORIC ANHYDRIDE			E	U	U		G	E	G	
PHOSPHOROUS TRICHLORIDE	U	G	E	U	U	G	G	E		
PHTHALIC ACID	G	P	G	P	P		E	E	E	
PHTHALIC ANHYDRIDE	G	P	G	P	P		E	E	E	
PICRIC ACID	P	U	G	P	E	G	G	E		
PINE OIL	G	G	E	E	U	U	E	E	E	
PINEAPPLE JUICE	P	P	E	E	E		E	E	E	

E-EXCELLENT

G-GOOD

P-POOR

U-UNSATISFACTORY



A  
B  
C  
D  
E  
F  
G  
H  
I  
J  
K  
L  
M  
N  
O

FLUID	BRASS	CARBON STEEL	216 S.S.	BUNA N (NITRILE)	NEO-PRENE	EPR	FLUORO-CARBON	PTFE	ACETAL	NYLON
PITCH			E	P	P	U		E		
PLATING SOLUTIONS, CHROME	E	U	E		U	E	E			
PLATING SOLUTIONS, OTHER		E	E	E	U	E	E			
PNEUMATIC SERVICE	E	E	E	E	E	E	E	E		
POLYSULFIDE LIQUOR	U		G	G	G	G	G	E		
POLYVINYL ACETATE	G		G		P	G		E		
POLYVINYL CHLORIDE	G		G		P	G		E		
POTASSIUM ACETATE	G	E	G	G	G	E	U			
POTASSIUM BICARBONATE			E	G				E		E
POTASSIUM BICHROMATE			E	G	G		G	E	G	
POTASSIUM BISULFATE			E	G	G		E	E		
POTASSIUM BISULFITE	P	U	G	E	E	G	E	E	E	
POTASSIUM BROMIDE	P	U	E	E	E	G	E	E	E	P
POTASSIUM CARBONATE	G	G	G	E	E	G	E	E	E	E
POTASSIUM CHLORATE	G	G	G	E	E	G	E	E	E	P
POTASSIUM CHLORIDE	P	P	G	E	E	E	E	E	E	P
POTASSIUM CHROMATE	G		G	G	E	G	G	E		
POTASSIUM CYANIDE	U	G	G	E	E	E	E	E	E	E
POTASSIUM DICHROMATE	U	P	G	E	E	G	E	E	E	U
POTASSIUM DIPHOSPHATE	G	E	E	E			E	E		
POTASSIUM FERRICYANIDE	U	P	E	E	E	G	E	E	E	
POTASSIUM FERROCYANIDE	G	P	G	E	E		E	E	E	
POTASSIUM HYDROXIDEDILUTE COLD	U	E	G	E	G		U	E		E
POTASSIUM HYDROXIDE DILUTE HOT	U	G	G	G	G			E		
POTASSIUM HYDROXIDE TO 70% COLD										
POTASSIUM HYDROXIDE TO 70% HOT	U	E	G	P	G	E		E		
POTASSIUM HYDROXIDE TO 70% HOT	U	E	G	P	G	E		E		
POTASSIUM IODIDE	U	P	G	E	E	G	E	E	E	
POTASSIUM NITRATE	G	G	G	E	E	G	E	E	E	P
POTASSIUM OXALATE			E					E		
POTASSIUM PERMANGANATE	G	G	G	E	E	G	E	E	E	U
POTASSIUM PHOSOHATE	P		G	E	E	E	E	E		
POTASSIUM PHOSPHATE DI-BASIC	G	E	E	E	E	G	E	E	E	
POTASSIUM PHOSPHATE TRI-BASIC		E	G	G	G	G		E		
POTASSIUM SALTS				E	E	E	E			
POTASSIUM SULFATE	G	G	E	E	E	E	E	E	E	P
POTASSIUM SULFIDE	G	G	E	E	G	G	G	E		
POTASSIUM SULFITE	G	G	E	G	G	E	G	E		
PRODUCER GAS	G	G	G	E	G	U	E	E	E	
PROPANE GAS	E	G	G	E	G	U	E	E	E	
PROPYL ACETATE	U	E	E	U	U	G	U			
PROPYL ALCOHOL	E	G	G	E	E		E	E		
PROPYL BROMIDE	G		G	G	G	G	G	E		
PROPYLENE	E	E	E	U	U	U	E			
PROPYLENE GLYCOL	G	G	G	E	E	G	E	E	P	
PYDRAUL	E	P	E	U	U		G	E		
PYRIDINE			G	U	U		U	E		
PYROGARD 42, 43, 53, 55				U	U	E	E			
PYROGARD D				E	G	E	E			
PYROLGALIC ACID	G	G	G	E	E		E	E	E	
QUENCH OIL	G	G	E	E	G		E	E	E	
QUININE, SULFATE, DRY			E					E		
R P-1 FUEL	E	E	E	G	P		E	E	E	
RESINS & ROSINS	E	P	E	P	P		E	E		
RESORCINOL			G					E		

E-EXCELLENT

G-GOOD

P-POOR

U-UNSATISFACTORY



FLUID	BRASS	CARBON STEEL	216 S.S.	BUNA N (NITRILE)	NEO-PRENE	EPR	FLUORO-CARBON	PTFE	ACETAL	NYLON
ROAD TAR	E	E	E	G	P	U	E	E	E	
ROOF PITCH	E	E	E	G	P		E	E	E	
ROSIN EMULSION	G	P	E	U	P		G	E		
RUBBER LATEX EMULSIONS	E	G	E				E	E	E	
RUBBER SOLVENTS	E	E	E	U	P		U	E	P	
SALAD OIL	G	P	G	E	E	G	E	E	E	
SALICYLIC ACID	P	U	E	E	E	G	E	E	E	
SALT	G	P	G	E	E		E	E	E	
SALT BRINE	G		G	E	U	G	G	E		
SAUERKRAUT ARINE			G					E		
SEA WATER	P	U	G	E	E	E	E	E	E	
SEWAGE	P	P	G	E	P	G	G	E		
SHELL IRUS 905				E	G	U	E			
SHELLAC	E	E	E	E	E			E		
SILICONE FLUIDS	G		G	G	G		G	E		
SILVER BROMIDE										
SILVER CYANIDE	U		E	G	G		G	E		
SILVER NITRATE	U	U	E	P	P	E	E	E	E	
SILVER PLATING SOL.			E		G			E		
SKYDROL 500	E	G	E	U	U		U	E		
SKYDROL 7000, TYPE 2	U	E	E	U	U	E	G			
SOAP SOLUTIONS	E	E	E	E	G	E	E	E		
SODIUM ACETATE	G	P	G	G	G	G	E	E	E	E
SODIUM ALUMINATE	G	P	E	E	E	G	E	E	E	
SODIUM BENZOATE			G					E		
SODIUM BICARBONATE	G	P	G	E	E	E	E	E	E	E
SODIUM BICHROMATE			G	U				E		
SODIUM BISULFATE 10%	G	U	E	E	E	G	E	E	E	P
SODIUM BISULFITE 10%	G	U	E	E	E	G	E	E	E	P
SODIUM BORATE	G	P	G	E	E	G	E	E	E	
SODIUM BROMIDE 10%	G	P	G	E	E	G	E	E	E	
SODIUM CARBONATE	G	G	E	E	E	G	E	E	E	E
SODIUM CHLORATE	G	P	G	E	E	G	E	E	E	P
SODIUM CHLORIDE	G	P	G	E	E	G	E	E	E	E
SODIUM CHROMATE	P	G	E	E	E	G	E	E	E	
SODIUM CITRATE			G					E		
SODIUM CYANIDE	U	G	E	E	E	G	E	E	E	E
SODIUM FERRICYANIDE			E					E		
SODIUM FLUORIDE	P	U	G	E	E	G	E	E	E	
SODIUM HYDROXIDE 20% COLD	E	E	E	E	E	G	G	E		E
SODIUM HYDROXIDE 20% HOT	E	G	E	G	G	G	P	E		
SODIUM HYDROXIDE 50% COLD	E	E	E	E	E	G	P	E		E
SODIUM HYDROXIDE 50% HOT	E	G	E	G	G	G	P	E		
SODIUM HYDROXIDE 70% COLD	E	E	E	G	P	G	P	E		
SODIUM HYDROXIDE 70% HOT	G	G	E	U	U	G	P	E		
SODIUM HYPOCHLORITE (BLEACH)	U	U	U				E	E		U
SODIUM HYPOSULFITE			G					E		
SODIUM LACTATE			E					E		
SODIUM METAPHOSPHATE	P	G	G	E	E	G		E		
SODIUM METASILICATE COLD	G	P	E	G	E		G	E		
SODIUM METASILICATE HOT	G	U	E					E		
SODIUM NITRATE	G	G	E	P	G	G	E	E	E	E
SODIUM NITRITE			G	P	U	E	G	E	G	
SODIUM PERBORATE	G	G	G	P	G	E	E	E	E	
SODIUM PEROXIDE	U	P	G	P	G	E	E	E	E	

E-EXCELLENT

G-GOOD

P-POOR

U-UNSATISFACTORY



A  
B  
C  
D  
E  
F  
G  
H  
I  
J  
K  
L  
M  
N  
O

FLUID	BRASS	CARBON STEEL	216 S.S.	BUNA N (NITRILE)	NEO-PRENE	EPR	FLUORO-CARBON	PTFE	ACETAL	NYLON
SODIUM PHOSPHATE	P	P	G	G	P	E	E	E	G	
SODIUM PHOSPHATE DI-BASIC	P	P	G	E	E	E	E	E	E	
SODIUM PHOSPHATE TRI-BASIC	P	P	G	G	G	E	E	E	E	
SODIUM POLYPHOSPHATE			G	G	G	E		E		
SODIUM SALICYLATE			E					E		
SODIUM SALTS										
SODIUM SILICATE	G	G	G	E	E	G	E	E	E	E
SODIUM SILICATE, HOT	P	P	G			G		E		
SODIUM SULFATE	G	G	E	E	E	E	E	E		E
SODIUM SULFIDE	U	G	G	E	E	G	E	E	E	E
SODIUM SULFITE	P		E	E	E	G	G	E		
SODIUM TETRABORATE			E	E	E	G		E		
SODIUM THIOSULFATE	P	G	E	E	E	E	E	E	E	
SOYBEAN	G	P	E	E	G	G	E	E	E	
STANNIC CHLORIDE	P	U	U	E	E		E	E		
STARCH	G	P	G	E	E	P	E	E	E	
STEAM (212 F)	E	E	E	U	U	G	P	E	U	
STEARIC ACID	P	P	G	E	P	G	E	E	E	
STODDARD SOLVENT	G	E	E	E	G	U	E			
STYRENE	E	E	E	U	U	U	G	E		
SUCROSE SOLUTIONS	E	E	E	E	G	E	E			
SUGAR, SYRUPS & JAM	G		E		G			E		
SUGAR LIQUIDS	E	G	E	E	E	G	E	E	E	
SULFATE, BLACK LIQUOR	P	P	G	P	G	G	P	E	E	
SULFATE, GREEN LIQUOR	P	P	G	P	G		P	E	E	
SULFATE, WHITE LIQUOR	P	P	G	P	G		P	E	E	
SULFUR	U	P	G	U	P	G	G	E	E	
SULFUR, MOLTEN	U	P	G	U	P	G	G	E		
SULFUR CHLORIDES	G	U	U	U	U	P	E	E	E	
SULFUR DIOXIDE, DRY	G	G	E	U	U	E	E	E	E	
SULFUR DIOXIDE, WET	U		E	U	U	G		E		
SULFUR HEXAFLUORIDE	G		E		G			E		
SULFUR TRIOXIDE	G	G	G	U	U		G	E		
SULFUR TRIOXIDE, DRY	G	G	G	U	U	G	E	E		
SULFURIC ACID 0 TO 77%	P	U	P	G	G		E	E	P	U
SULFURIC ACID 100%	P	P	E	U	U	P	G	E	U	U
SULFUROUS ACID	U	U	G	P	P	P	E	E	P	
SUNSAFE	U	E	E	E	G	U	E			
TALL OIL	G	G	G	G	G	U	E	E		
TANNIC ACID	G	P	G	G	G	G	E	E	E	U
TANNING LIQUORS			G	G	U			E		
TAR & TAR OILS	E	E	E	P	U	U	E	E		
TARTARIC ACID	G	U	E	P	G	G	E	E	E	
TERPINEOL				G	U	U	E			
TERTIARY BUTYL ALCOHOL	E	E	E	G	G	G	E			
TETRACHLOROETHANE		G	E	U	U	U	E			
TETRACHLOROETHYLENE	U	G	U	U	U	E				
TETRAETHYL LEAD	G	P	G					E	E	
TITANIUM TETRACHLORIDE	G	E	G	G	U	U	E			
TOLUOL (TOLUENE)	E	E	E	U	U	U	G	E	E	E
TOMATO JUICE	P	P	E	E	E		E	E	E	
TRANSFORMER OIL	G	E	E	E	G		E	E	E	
TRANSMISSION FLUID, TYPE A	E	E	E	E	G	U	E			
TRIBUTYL PHOSPHATE	E	E	E	U	U	G	U	E		
TRICHLOROETHYLENE	G	G	G	U	U	U	G	E	E	U

E-EXCELLENT

G-GOOD

P-POOR

U-UNSATISFACTORY



FLUID	BRASS	CARBON STEEL	216 S.S.	BUNA N (NITRILE)	NEO-PRENE	EPR	FLUORO-CARBON	PTFE	ACETAL	NYLON
TRICHLOROACETIC ACID	G		U	P	U		U	E		
TRICHLOROETHANE		G	E	U	U	U	E			
TRICRESYL PHOSPHATE		E	G	U	U	E	G			
TRIETHANOLAMINE			G	P	G	G		E		
TRIETHYLAMINE	G		G	G	G			E		
TRISODIUM PHOSPHATE			G	E	E	G	G	E		
TUNG OIL	G	G	E	E	G	U	E	E	E	
TURBINE OIL #15		G	E	G	U	U	E			
TURPENTINE	G	G	G	G	U	U	E	E	E	E
UREA	U	P	G	P	G	G	U	E	E	
URIC ACID			E					E		
VARNISH	E	P	E	P	G	U	G	E	E	
VEGETABLE OILS	G	G	E	E	G	U	E	E	E	
VINEGAR	G	U	E	U	U	E	U	E		E
VINYL ACETATE	G		G		G	E		E		
WATER, ACID MINE	U	U	G	G	E	E	U	E		
WATER, DISTILLED	U	U	E	P	G	G	E	E	E	
WATER, FRESH	P	P	E	P	G	G	E	E	E	
WAXES	E	E	E	E	G	P	E	E	E	
WHISKEY & WINES	G	U	E	G	G	E	E	E	E	
XYLENE (XYLOL), DRY	E	G	E	U	U	U	G	E	E	E
ZINC BROMIDE	G		G	G	G	G	G	E		
ZINC CHLORIDE	U	U	U	G	G		E	E		U
ZINC HYDROSULFITE	P	E	E	E	E	E	E	E	E	
ZINC SULFATE	G	U	G	E	E	E	E	E	E	P

E-EXCELLENT

G-GOOD

P-POOR

U-UNSATISFACTORY

- A
- B
- C
- D
- E
- F
- G
- H
- I
- J
- K
- L
- M
- N
- O



1F.....	H7	48F-X-MIX.....	H9	62PCABH.....	G13, G30
2GF.....	H7	48IFHD.....	H15	62PLM.....	A50
3GF.....	H7	50CT.....	L11	62PLMBH.....	A50
4CB-SR.....	L9	50GHSV.....	J26	62PLMSP.....	A52
9-DC.....	L10	53GH.....	J26	62PLP.....	A7, A15
14FL.....	H7	54GH.....	J26	62PLPBH.....	A7
14FS.....	H7	55GH.....	J26	62PLPSP.....	A15
14FSX.....	H7	56PSG.....	G29	62PLS.....	A58
16-CB.....	L9	56RBSG.....	F18	62PLSBH.....	A59
18-DC.....	L10	59CA.....	G13	62PTC.....	E13
20.....	I6	59HD.....	G38	62RB.....	F18
22.....	I6	59P.....	G29	62TF.....	F12
22BH.....	I6	60AB.....	F14	62VL.....	F20
22CA.....	I6	60C.....	G8	63NTA.....	F8
22CABH.....	I6	60NTA.....	F7	63PLM.....	A52
24B-Cabinet.....	L10	60P.....	G29	63PLP.....	A38
24-CB.....	L9	60PB.....	G29	63PT.....	G9, G14
24M.....	E10	60PT.....	G8	66AB.....	F14
24PLP.....	A35	60RB.....	F18	66BBJ.....	A32
24PLPD.....	A36	60TF.....	F12	66C.....	G9
26.....	I6	60VL.....	F20	66CA.....	G14
27.....	I6	60VLV.....	F20	66HD.....	G36
28.....	I7	61AB.....	F14	66LF.....	A20, A21
30GH.....	C43	61C.....	G8	66NBH.....	F8
31GH.....	C43	61CA.....	G13	66NTA.....	F8
31HB.....	C43	61CL.....	G8	66P.....	G30
32PLCK.....	B29	61HD.....	G36	66PLM.....	A46
32PLP.....	A33	61NTA.....	F7	66PLMBH.....	A50
32PLPBH.....	A35	61P.....	G29	66PLP.....	A8
32PLPBHP.....	A41	61PB.....	G29	66PLPBH.....	A8
32PLPDJ.....	A32	61PN.....	G29	66PTC.....	E13
32PLPDJB.....	A31	61PSGN.....	G29	66RBSV.....	F18
32PLPDRC.....	A40	61RB.....	F18	66VL.....	F21
32PLPRC.....	A40	61RBSG.....	F18	67PLM.....	A51
32PLPSP.....	A39	61TF.....	F12	67PLP.....	A15
32PTC.....	E7	61VL.....	F20	67PLS.....	A60
37PLP.....	A39	62AB.....	F14	67RBSG.....	F18
37PTCSP.....	E8	62ABH.....	F14	68ALS.....	E23
40B-Cabinet.....	L11	62ANBH.....	F7	68BBJ.....	A31
41FL.....	H8	62C.....	G8	68BJBD.....	A32
41FS.....	H8	62CA.....	G13	68BJBT.....	A32
41FX.....	H8	62CABH.....	G13	68C.....	G9
41IF.....	H15	62HD.....	G36	68CA.....	G14
42F.....	H8	62HDBH.....	G36	68HB.....	I10
42IFHD.....	H15	62NBH.....	F7	68HB-X-MI.....	J24
43F.....	H8	62NFBH.....	F7	68HB-X-MIX.....	I10
46F.....	H9	62NTA.....	F7	68HD.....	G37
46IFHD.....	H15	62P.....	G29, G30	68LF.....	A22
48F.....	H9	62PBH.....	G30	68LFR.....	A21
48F-X-MI.....	J24	62PCA.....	G13, G30	68NTA-X-MI.....	J24

68NTA-X-MIX.....F8	0111 .....G25	164PLP .....A10
68P.....G31	0114 .....G20	164PLS .....A59
68PLCK.....B30	0116 .....G23	164PMT .....E14
68PLCKI.....B30	0117 .....J15	164VL.....F21
68PLM.....A46	0118.....G22	165C.....G10
68PLMSP.....A47	0119.....G22, G23	165CA.....G15
68PLP.....A9, A10	0121.....J15	165HD.....G36
68PLPR.....A10	122HBL.....I10	165PLM.....A51
68PLPSP.....A29	122PLMSP.....A52	165PLMBH.....A51
68PLS.....A55	0123.....I13	165PLP.....A11
68PLSSP.....A56	0124.....G25	165PLS.....A59
68PTC.....E14	0125.....G27	165PMT.....E14
68RB.....F18	125HB.....I10	165PMTBH.....E18
68RBSG.....F18	125HBL.....I10	166FSV.....H12
68TF.....F12	125HBLSV.....I11	0168.....G27, J16
68VL.....F21	126HBL.....I11	0169.....J16
69GH.....J26	0127.....G27	169C.....G10
70GH.....J26	127HB.....I11	169CA.....G15
71GH.....J26	128HBLSV.....I11	169HB-X-MI.....J24
75GH.....J26	129HB.....I11	169HB-X-MIX.....I12
76RB.....F18	0136.....I14	169HD.....G37
78GH.....J26	0139.....A16	169LP.....G33
79GH.....J26	139HB.....I12	169P.....G33
80GH.....J26	139PLP.....A15	169PLM.....A47, A48
81GH.....J26	0142.....G24	169PLMBJ.....A52
82GH.....J26	0143.....J14	169PLMX.....A48
83GH.....J26	0144.....J14	169PLP.....A12
88AC.....H19	144F.....H10	169PLS.....A57
88GH.....J26	0145.....J14	169PLSX.....A58
90GH.....J26	145F.....H10	169PMT.....E14
94GH.....J26	146HBLFSV.....I12	169PMTBH.....E18
95GH.....J27	149F.....H10	169PMTL.....E15
96GH.....J27	149F-X-MI.....J24	169PMTNS.....E15
97HC.....I13	149F-X-MIX.....H11	169PMTNS-X-M.....E4, E15
97P.....G31	150F.....H11	169VL.....F21
98GH.....J27	151F.....H11	170C.....G11
98GHSV.....J27	0152.....J14	170CA.....G16
99GH.....J27	0155.....J16	170HD.....G37
99GHSV.....J27	155F.....H11	170P.....G34
0101.....G18, G19	0158.....J15	170PMT.....E15
101GHSV.....J27	159F.....H12	170PMTNS.....E15
0102.....G24	159F-X-MI.....J24	170VL.....F22
0103.....G22	159F-X-MIX.....H12	171C.....G11
0104.....G24	0163.....J16	171CA.....G16
0105.....G18	0164.....J14	171HB.....I12
0106.....G23	164C.....G10	171HD.....G37
0107.....G24	164CA.....G15	171P.....G34
0108.....G21	164HD.....G36	171PLM.....A48, A49
0109.....G20, G21	164P.....G33	171PLP.....A13
0110.....G25, G27	164PLM.....A51	171PMT.....E16

A

B

C

D

E

F

G

H

I

J

K

L

M

N

0



A	171PMTNS ..... E16	228 ..... I8	347PLP ..... A36
	171VL ..... F22	229 ..... I8	362HB ..... C42
	172C ..... G11	230 ..... I8	362PLP ..... A34
	172CA ..... G16	231 ..... I8	362PLPD ..... A35
B	172HD ..... G37	232 ..... I8	362PLPDSP ..... A38
	172P ..... G34	237 ..... I8	362PLPSP ..... A38
	172PLM ..... A49, A50	238 ..... I8	362PTC ..... E7
C	172PLP ..... A14	244F ..... H10	362PW ..... A15
	172PMT ..... E16	244IFHD ..... H16	364HB ..... C40
	172PMTNS ..... E16	245IFHD ..... H16	364PLP ..... A34
	172VL ..... F22	249F ..... H10	364PTC ..... E7
D	176C ..... G11	249IF ..... H16	365HB ..... C40
	176CA ..... G16	250IFHD ..... H16	365PLP ..... A33, A34
	177C ..... G11	251IFHD ..... H16	365PLPBH ..... A35
	177CA ..... G16	252IFHD ..... H16	365PTC ..... E7
E	177HD ..... G38	255IFHD ..... H16	368PLP ..... A29
	177P ..... G34	255M ..... J12	368PLPD ..... A30
	179C ..... G11	256F ..... H13	369PLP ..... A23
	179CA ..... G16	259F ..... H12	369PLPBJ ..... A31
F	179HB ..... I12	259IFHD ..... H16	369PLPBJB ..... A31
	179HB-X-MI ..... J24	264AB ..... F15	369PLPO ..... A43
	179HD ..... G37	264C ..... G10	369PLPSP ..... A36
G	179PMT ..... E17	264CA ..... G15	369PLPSPX ..... A37
	179PMTNS ..... E17	264NTA ..... F9	369PLPTJ ..... A32
	179VL ..... F22	265AB ..... F15	369PLPTJB ..... A31
H	189PMTR ..... E17	265C ..... G10	369PLPX ..... A24
	0191 ..... I14	265CA ..... G15	369PTCSP ..... E8
	0192 ..... J20	265NTA ..... F9	370HB ..... C42
	0199 ..... G21	269C ..... G10	370PLP ..... A30
I	207ACBH ..... F16	269CA ..... G15	370PTCR ..... E8
	207P ..... J8	269HB ..... I13	371PLP ..... A28
	208P ..... J8	269TF ..... F12	371PLPSP ..... A37, A38
J	209P ..... J8	270AB ..... F15	371PTCSP ..... E9
	210P ..... J9	270C ..... G11	372HB ..... C42
	211P ..... J9	270CA ..... G16	372PLP ..... A27
	212P ..... J9	270NTA ..... F9	372PLPSP ..... A37
K	213P ..... J9	279HB ..... I13	372PTCSP ..... E9
	215PN ..... J9	309P ..... C40	376PLPBJ ..... A32
	215PNL ..... J9	313GH ..... C43	377PLP ..... A27
L	216P ..... J10	316GH ..... C43	377PTC ..... E9
	218P ..... J10	316P ..... C41	379PLP ..... A25
	219P ..... J10	318P ..... C40	379PLPSP ..... A37
M	0220 ..... G27, I7	322HB ..... C40	391P ..... G31
	220P ..... J10	322PLPSP ..... A39, A40	391PSS ..... G31
	222P ..... J10	325GH ..... C43	392P ..... G31
	222P-X-MI ..... J24	325GHSV ..... C43	392PSS ..... G31
N	222P-X-MIX ..... J14	325HB ..... C41	393P ..... G31
	224 ..... I7	326HB ..... C41	393PD ..... G32
	225 ..... I7	328HB ..... C43	393PDSS ..... G32
0	226-BPD ..... M6	329HB ..... C42	393PSS ..... G31



394P.....G32	881AC.....H19	2200PDE.....J12
394PD.....G32	0900.....J19	2201P.....J12
394PDSS.....G32	901GH.....J27	2202P.....J11
394PSS.....G32	0902.....J20	2203P.....J11
398P.....G32	0903.....J18	2205P.....J12
398PD.....G33	0904.....J19	2214P.....J12
398PDSS.....G33	0905.....J19	2224P.....J11
398PSS.....G32	0906.....J19	2225P.....J11
400-S-TIP.....L5	0907.....J19	2491FHD.....H16
410.....L5	0908.....J18	3000 71 11.....M5
410-N.....L5	0909.....J18	3000 71 11 05.....M5
410-S.....L5	0910.....J17	3100.....D6
410-SV.....L5	0911.....J17	3110.....A41
411FF.....H15	0912.....J17	3151.....A40
411FS.....H15	0913.....J17	3330.....A41
415-N.....L5	0914.....J17	4202.....K60
415-S.....L5	0915.....J17	4203.....K60
485F.....H9	0916.....J18	4890.....B32
0610.....L7	0917.....J18	4891.....B32
0611.....L8	0920.....J19	4892.....B32
0614.....L8	0921.....J17	4895.....B32
639C.....G11	0922.....J17	6300.....D8
639CA.....G16	0923.....J18	6302.....C11
639F.....H13	0924.....J18	6304.....C10
639PLM.....A52	0927.....J18	6306.....C10
639PLP.....A39, E19	0928.....J18	6307.....C13
639PLS.....A60	0929.....J15	6315.....C7
640F.....H13	0931.....I14	6316.....C7
640QSF.....H19	945TH-BPD.....M6	6322.....C13
640QSFCR.....H19	1163-60-BPD.....J27	6325.....C8
0660.....B36	1163-61-BPD.....J27	6326.....C13
660FHD.....H13	1200P.....J10	6340.....C11
0661.....B36	1201P.....J12	6351.....C12
661FHD.....H13	1202P.....J11	6366.....C11
664FHD.....H13	1203P.....J11	6380.....C13
0670.....L7	1204P.....J11	6382.....C12
0671.....L7	1295HB.....I11	6383.....C12, C13
0672.....L8	01300.....I15	6388.....C12
0673.....L7	01400-xx.....I15	6503.....C9, C10
0674.....L8	1495F.....H11	6505.....C7
0676.....L8	01500.....I15	6508.....C9
0677.....L7	1595F.....H12	6509.....C8, C9
0682.....L8	01600.....I15	6521.....C8
682C.....G11	01640.....I15	6548.....C13
682CA.....G16	1695HB.....I12	6579.....C8
682VL.....F21	1695VLV.....F22	7800/7801.....B41
0683.....L8	01700.....I15	7805/7806.....B41
685HB.....I10	1725HB.....I12	7810.....B27
685VLV.....F21	1795HB.....I13	7812.....B27
880AC.....H19	2200P.....J10	7815.....B27

A

B

C

D

E

F

G

H

I

J

K

L

M

N

0

7817.....	B27	DC606 .....	K69	JPMTB .....	E21
7835 .....	B27	DC607 .....	K69	LSR-Stand .....	L10
7892 .....	B34	DCR601 .....	K69	LV91.....	F24
7894 .....	B34	ERHD.....	E18	MC .....	C19, C33
7970 .....	B37	ES .....	E18	MCVC .....	C27
7982 .....	B37	EU .....	C19, C33	ME.....	C23, C33
A613.....	E23	F2PMTB.....	E21	MES.....	C20
A614 .....	E23	F3HG .....	J14	MR .....	C34
A623 .....	E23	F8UPMTB.....	E21	MRS .....	C20
A624 .....	E23	FA.....	C20	MT.....	C34
ACT-P-X-KIT.....	K53	FC .....	C22, C34	MTS.....	C21
ACT-SS-X-KIT .....	K53	FC601 .....	B39	MV200 .....	K42
ADJ-CB.....	L9	FC602.....	B39	MV308 .....	B45
AQRT .....	A41, C30, E11, E19	FC608.....	B39	MV309 .....	B45
AS .....	C9	FC701 .....	B23	MV608 .....	K42
AVC1.....	H18	FC702.....	B23	MV609 .....	K42
AVE1 .....	H18	FC703.....	B24, B25	MV708 .....	K40
AVT3 .....	H18	FC705.....	B23	MV709 .....	K40
AVTS .....	H18	FC708.....	B23	MVV308 .....	B45
AVTS4 .....	H19	FC731 .....	B8	MVV309 .....	B45
AVTS6.....	H19	FC832 .....	B20	NS .....	C35
AVU1 .....	H18	FC836.....	B21	NV101F .....	K65
AVU2.....	H18	FCB832.....	B20	NV102F .....	K65
AVU2BH .....	H18	FCC731 .....	B8	NV103F .....	K65
AVUIFI.....	H18	FCCB731.....	B9	NV104C.....	K65
AVUR3.....	H18	FCCI731 .....	B8	NV104CA.....	K65
AVUS .....	H19	FCCS731 .....	B15, B16	NV105C.....	K65
AVUS3.....	H19	FCCSP731 .....	B18	NV105CA.....	K65
AVUS4D .....	H19	FCCSPI731 .....	B18	NV106C.....	K66
Avuse.....	H18	FCI701 .....	B23	NV106CA.....	K66
BG441-NBL .....	L6	FCI702 .....	B23	NV107P .....	K66
BG442-SBL .....	L6	FCK701C.....	B23	NV108P.....	K66
BG443-NBL.....	L6	FCKC731 .....	B9	NV109P.....	K66
BG444-SBL .....	L6	FCKCB731.....	B10	NV311P .....	G34, K66
BU .....	C22, C34	FCKCI731 .....	B10	NV312P .....	G34, K66
BVC .....	C16, C30	FCM731 .....	B12	OR.....	C35
BVG4PLOCK.....	K57	FCMB731 .....	B13	PLMC.....	A52, D11
BVGL .....	K55	FCMI731.....	B12	PLSC .....	A60, D11
BVGTL .....	K55	FCMK731 .....	B13	Pneu-Cab.....	L11
C8UPMTB .....	E21	FCMS731 .....	B15	PSBJ708 .....	B43
CAP .....	C24	FCMSI731 .....	B16	PSBJ731 .....	B43
Clip.....	A40	FCMSP731 .....	B18	PSPE731 .....	B43
Copper Tubing.....	L11	FCMSPI731 .....	B4, B18	PSPJ731.....	B43
CR-001 .....	H19	FCPM832 .....	B21	PTC-001RB .....	M5
CU .....	C24	FE.....	C25, C34	PV607 .....	K50
DB .....	A16	FF.....	C24	PV608 .....	K50
DC601.....	K68	GR.....	C35	PV609.....	K50
DC602 .....	K69	HPMTB .....	E21	PVMB-001.....	K50
DC603 .....	K69	HV104C.....	K65	RD .....	C23
DC604 .....	K69	HV104C-kit.....	K65	S8UPMTB .....	E21

SAE 010101.....	H8	SAE 100115.....	F7	V405P.....	F24
SAE 010102.....	H9	SAE 100201 BA.....	F9	V406P.....	K68
SAE 010103.....	H9	SAE 100202 BA.....	F9	V407P.....	K68
SAE 010104.....	H8	SAE 100203 BA.....	F9	V408NTA.....	F24
SAE 010105.....	H13	SAE 100302 BA.....	F10	V409F.....	F24
SAE 010106.....	H13	SAE 100401 BA.....	F9	V410NTA.....	F24
SAE 010107.....	H13	SAE 100424 BA.....	F9	V412F.....	F24
SAE 010109.....	H13	SAE 100425 BA.....	F10	V500CS.....	K31
SAE 010110.....	H8	SAE 120101 BA.....	F14	V500CS-X-04.....	K31
SAE 010111.....	H8	SAE 120102 BA.....	F14	V500CS-X-21.....	K32
SAE 010112.....	H13	SAE 120103 BA.....	F14	V500HP.....	K35
SAE 010113.....	H7	SAE 120111.....	F14	V500P.....	K9
SAE 010114.....	H7	SAE 120115.....	F14	V500P-HB.....	K27
SAE 010165.....	H7	SAE 120201 BA.....	F15	V500P-X-04.....	K10
SAE 010166.....	H7	SAE 120202 BA.....	F15	V500P-X-21.....	K10
SAE 010167.....	H7	SAE 120203 BA.....	F15	V501P.....	K11
SAE 010201.....	H11	SAE 120302 BA.....	F16	V501P-X-04.....	K12
SAE 010202.....	H10	SAE 120401 BA.....	F15	V501P-X-21.....	K12
SAE 010203.....	H11	SAE 120424 BA.....	F15	V501SS.....	K37
SAE 010302.....	H12	SAE 120425 BA.....	F16	V502CS.....	K31
SAE 010401.....	H10	SC.....	C30	V502CS-X-21.....	K32
SAE 010424.....	H11	SPV104C-kit.....	K65	V502P.....	K14
SAE 010425.....	H10	ST.....	C24	V502P-X-04.....	K14
SAE 040101.....	H15	STX-P-1-125.....	K63	V502P-X-ACT.....	K52
SAE 040102.....	H15	STX-P-1-225.....	K63	V502P-X-SUB.....	K53
SAE 040103.....	H15	SV404P.....	F24	V502SS.....	K39
SAE 040110.....	H15	TAF.....	C24	V502SS-X-20.....	K39
SAE 040202.....	H16	TC-1000-BPD.....	M5	V502SS-X-21.....	K39
SAE 040203.....	H16	TCB.....	C24	V502SS-X-ACT.....	K52
SAE 040302.....	H16	TEB.....	C25	V502SS-X-SUB.....	K53
SAE 040401.....	H16	TEU.....	C23	V506CS.....	K33
SAE 040424.....	H16	TFA.....	C24	V506HP.....	K36
SAE 040425.....	H16	TMC.....	C22	V506P.....	K16
SAE 040427.....	H16	TPL.....	A15, C25	V509P.....	K17
SAE 060101 BA.....	G8	TS.....	C30	V510P.....	K19
SAE 060102 BA.....	G9	TSC.....	C26, D10	V510P-X-04.....	K19
SAE 060103 BA.....	G9	TU.....	C19, C34	V510P-X-21.....	K19
SAE 060110.....	G8	UC.....	C21, C33	V533P.....	K24
SAE 060111.....	G8	US5.....	H7	V540P.....	K24
SAE 060115.....	G8	V203F.....	K68	V590P.....	K26
SAE 060201 BA.....	G10	V204F.....	K68	V590P-X-04.....	K26
SAE 060202 BA.....	G10	V303C.....	K68	V591P.....	K26
SAE 060203 BA.....	G11	V303CA.....	K68	V591P-X-04.....	K26
SAE 060401 BA.....	G10	V304C.....	K68	V600P.....	K29
SAE 060424 BA.....	G11	V304CA.....	K68	V633P.....	K29
SAE 060425 BA.....	G11	V401P.....	K68	VAS.....	C16, K6, K45
SAE 100101 BA.....	F7	V402P.....	K68	VC.....	B30, C27
SAE 100102 BA.....	F8	V403P.....	K68	VC-001.....	H19
SAE 100103 BA.....	F8	V404P.....	F24	VEU.....	C15, C30, K6, K44, K46, K48
SAE 100110.....	F7	V404PH.....	F24	VFC.....	C29, C27, C36, C15, K6, K45, K46,

A

B

C

D

E

F

G

H

I

J

K

L

M

N

0





K47, K48	W369PLPBJ..... A30
VFE.....C28, C26, C37, C15, K6, K44, K45, K47, K48	W369PLPO ..... A43, A18
VMC .... C15, C29, K6, K45, K46, K47, K48	W369PLPTJ ..... A32
VME.....C14, C28, C37, C44, K6, K44, K45, K47, K48	W369PLPX.....A24
VP500CS..... K31	W371PLP .....A27, A28
VP500HP..... K35	W372PLP..... A25, A26
VP500P .....K9	W379PLP..... A24, A25
VP501P ..... K12	WY ..... C21
VP502CS..... K31	
VP502P..... K14	
VP502SS..... K39	
VP510P ..... K19	
VS68AB..... F14	
VS68NTA..... F8	
VS68PTCR..... E4	
VS176NTA ..... F8	
VS269AB ..... F15	
VS269NTA ..... F9	
VS271AB ..... F15	
VS272AB ..... F16	
VS272NTA ..... F10	
VS279AB ..... F16	
VS279NTA ..... F10	
VS368PTCR..... E7	
VS369PTCR..... E8	
VS371PTCR ..... E9	
VS372PTCR ..... E9	
VTEU..... C30, K6, K46	
VUC .... C29, C29, C30, C36, C14, K6, K44, K46, K47, K48	
VUCPB..... C16, C44, K6, K45, K47	
VV500P .....K9	
VV501P ..... K12	
VV502P ..... K14	
VVP500P .....K9	
VVP501P ..... K12	
VVP502P ..... K14	
W68LF..... A20, A21	
W68PLCK..... B29	
W68PLCKI ..... B29	
W68PLP ..... A9	
W68PLPSP ..... A28	
W169PLP..... A11, A12	
W169PLPNS ..... A12	
W171PLP ..... A13	
W172PLP ..... A14	
W368PLP ..... A29	
W369PLP ..... A22, A23	

## Parker Safety Guide for Selecting and Using Hose, Tubing, Fittings, Connectors, Conductors, Valves and Related Accessories

Parker Publication No. 4400-B.1

**WARNING:** Failure or improper selection or improper use of hose, tubing, fittings, assemblies, valves, connectors, conductors or related accessories (“Products”) can cause death, personal injury and property damage. Possible consequences of failure or improper selection or improper use of these Products include but are not limited to:

- Fittings thrown off at high speed.
- High velocity fluid discharge.
- Explosion or burning of the conveyed fluid.
- Electrocution from high voltage electric powerlines.
- Contact with suddenly moving or falling objects that are controlled by the conveyed fluid.
- Injections by high-pressure fluid discharge.
- Dangerously whipping Hose.
- Tube or pipe burst.
- Weld joint fracture.
- Contact with conveyed fluids that may be hot, cold, toxic or otherwise injurious.
- Sparking or explosion caused by static electricity buildup or other sources of electricity.
- Sparking or explosion while spraying paint or flammable liquids.
- Injuries resulting from inhalation, ingestion or exposure to fluids.

Before selecting or using any of these Products, it is important that you read and follow the instructions below. No product from any division in Fluid Connector Group is approved for in-flight aerospace applications. For hoses and fittings used in in-flight aerospace applications, please contact Parker Aerospace Group

### GENERAL INSTRUCTIONS

- 1.0 Scope:** This safety guide provides instructions for selecting and using (including assembling, installing, and maintaining) these Products. For convenience, all rubber and/or thermoplastic products commonly called “hose” or “tubing” are called “Hose” in this safety guide. Metallic tube or pipe are called “tube”. All assemblies made with Hose are called “Hose Assemblies”. All assemblies made with Tube are called “Tube Assemblies”. All products commonly called “fittings”, “couplings” or “adapters” are called “Fittings”. Valves are fluid system components that control the passage of fluid. Related accessories are ancillary devices that enhance or monitor performance including crimping, flaring, flanging, presetting, bending, cutting, deburring, swaging machines, sensors, tags, lockout handles, spring guards and associated tooling. This safety guide is a supplement to and is to be used with the specific Parker publications for the specific Hose, Fittings and Related Accessories that are being considered for use. Parker publications are available at [www.parker.com](http://www.parker.com). SAE J1273 ([www.sae.org](http://www.sae.org)) and ISO 17165-2 ([www.ansi.org](http://www.ansi.org)) also provide recommended practices for hydraulic Hose Assemblies, and should be followed.
- 1.1 Fail-Safe:** Hose, Hose Assemblies, Tube, Tube Assemblies and Fittings can and do fail without warning for many reasons. Design all systems and equipment in a fail-safe mode, so that failure of the Hose, Hose Assembly, Tube, Tube Assembly or Fitting will not endanger persons or property.
- 1.2 Distribution:** Provide a copy of this safety guide to each person responsible for selecting or using Hose, Tube and Fitting products. Do not select or use Parker Hose, Tube or Fittings without thoroughly reading and understanding this safety guide as well as the specific Parker publications for the Products.
- 1.3 User Responsibility:** Due to the wide variety of operating conditions and applications for Hose, Tube and Fittings, Parker does not represent or warrant that any particular Hose, Tube or Fitting is suitable for any specific end use system. This safety guide does not analyze all technical parameters that must be considered in selecting a product. The user, through its own analysis and testing, is solely responsible for:
- Making the final selection of the Products.
  - Assuring that the user’s requirements are met and that the application presents no health or safety hazards.
  - Following the safety guide for Related Accessories and being trained to operate Related Accessories.
  - Providing all appropriate health and safety warnings on the equipment on which the Products are used.
  - Assuring compliance with all applicable government and industry standards.
- 1.4 Additional Questions:** Call the appropriate Parker technical service department if you have any questions or require any additional information. See the Parker publication for the Products being considered or used, or call 1-800-CPARKER, or go to [www.parker.com](http://www.parker.com), for telephone numbers of the appropriate technical service department.

### 2.0 HOSE, TUBE AND FITTINGS SELECTION INSTRUCTIONS

- 2.1 Electrical Conductivity:** Certain applications require that the Hose be nonconductive to prevent electrical current flow. Other applications require the Hose and the Fittings and the Hose/Fitting interface to be sufficiently conductive to drain off static electricity. Extreme care must be exercised when selecting Hose, Tube and Fittings for these or any other applications in which electrical conductivity or nonconductivity is a factor.
- The electrical conductivity or nonconductivity of Hose, Tube and Fittings is dependent upon many factors and may be susceptible to change. These factors include but are not limited to the various materials used to make the Hose and the Fittings, Fitting finish (some Fitting finishes are electrically conductive while others are nonconductive), manufacturing methods (including moisture control), how the Fittings contact the Hose, age and amount of deterioration or damage or other changes, moisture content of the Hose at any particular time, and other factors.
- The following are considerations for electrically nonconductive and conductive Hose. For other applications consult the individual catalog pages and the appropriate industry or regulatory standards for proper selection.
- 2.1.1 Electrically Nonconductive Hose:** Certain applications require that the

Hose be nonconductive to prevent electrical current flow or to maintain electrical isolation. For applications that require Hose to be electrically nonconductive, including but not limited to applications near high voltage electric lines, only special nonconductive Hose can be used. The manufacturer of the equipment in which the nonconductive Hose is to be used must be consulted to be certain that the Hose, Tube and Fittings that are selected are proper for the application. Do not use any Parker Hose or Fittings for any such application requiring nonconductive Hose, including but not limited to applications near high voltage electric lines or dense magnetic fields, unless (i) the application is expressly approved in the Parker technical publication for the product, (ii) the Hose is marked “nonconductive”, and (iii) the manufacturer of the equipment on which the Hose is to be used specifically approves the particular Parker Hose, Tube and Fittings for such use.

- 2.1.2 Electrically Conductive Hose:** Parker manufactures special Hose for certain applications that require electrically conductive Hose. Parker manufactures special Hose for conveying paint in airless paint spraying applications. This Hose is labeled “Electrically Conductive Airless Paint Spray Hose” on its layline and packaging. This Hose must be properly connected to the appropriate Parker Fittings and properly grounded in order to dissipate dangerous static charge buildup, which occurs in all airless paint spraying applications. Do not use any other Hose for airless paint spraying, even if electrically conductive. Use of any other Hose or failure to properly connect the Hose can cause a fire or an explosion resulting in death, personal injury, and property damage. All hoses that convey fuels must be grounded. Parker manufactures a special Hose for certain compressed natural gas (“CNG”) applications where static electricity buildup may occur. Parker CNG Hose assemblies comply with the requirements of ANSI/IAS NGV 4.2; CSA 12.52, “Hoses for Natural Gas Vehicles and Dispensing Systems” ([www.ansi.org](http://www.ansi.org)). This Hose is labeled “Electrically Conductive for CNG Use” on its layline and packaging. This Hose must be properly connected to the appropriate Parker Fittings and properly grounded in order to dissipate dangerous static charge buildup, which occurs in, for example, high velocity CNG dispensing or transfer. Do not use any other Hose for CNG applications where static charge buildup may occur, even if electrically conductive. Use of other Hoses in CNG applications or failure to properly connect or ground this Hose can cause a fire or an explosion resulting in death, personal injury, and property damage. Care must also be taken to protect against CNG permeation through the Hose wall. See section 2.6, Permeation, for more information. Parker CNG Hose is intended for dispenser and vehicle use within the specified temperature range. Parker CNG Hose should not be used in confined spaces or unventilated areas or areas exceeding the specified temperature range. Final assemblies must be tested for leaks. CNG Hose Assemblies should be tested on a monthly basis for conductivity per ANSI/IAS NGV 4.2; CSA 12.52. Parker manufactures special Hose for aerospace in-flight applications. Aerospace in-flight applications employing Hose to transmit fuel, lubricating fluids and hydraulic fluids require a special Hose with a conductive inner tube. This Hose for in-flight applications is available only from Parker’s Stratoflex Products Division. Do not use any other Parker Hose for in-flight applications, even if electrically conductive. Use of other Hoses for in-flight applications or failure to properly connect or ground this Hose can cause a fire or an explosion resulting in death, personal injury and property damage. These Hose assemblies for in-flight applications must meet all applicable aerospace industry, aircraft engine and aircraft requirements.

- 2.2 Pressure:** Hose, Tube and Fitting selection must be made so that the published maximum working pressure of the Hose, Tube and Fittings are equal to or greater than the maximum system pressure. The maximum working pressure of a Hose, or Tube Assembly is the lower of the respective published maximum working pressures of the Hose, Tube and the Fittings used. Surge pressures or peak transient pressures in the system must be below the published maximum working pressure for the Hose, Tube and Fitting. Surge pressures and peak pressures can usually only be determined by sensitive electrical instrumentation that measures and indicates pressures at millisecond intervals. Mechanical pressure gauges indicate only average pressures and cannot be used to

- determine surge pressures or peak transient pressures. Published burst pressure ratings for Hose is for manufacturing test purposes only and is no indication that the Product can be used in applications at the burst pressure or otherwise above the published maximum recommended working pressure.
- 2.3 Suction:** Hoses used for suction applications must be selected to insure that the Hose will withstand the vacuum and pressure of the system. Improperly selected Hose may collapse in suction application.
- 2.4 Temperature:** Be certain that fluid and ambient temperatures, both steady and transient, do not exceed the limitations of the Hose, Tube, Fitting and Seals. Temperatures below and above the recommended limit can degrade Hose, Tube, Fittings and Seals to a point where a failure may occur and release fluid. Tube and Fittings performances are normally degraded at elevated temperature. Material compatibility can also change at temperatures outside of the rated range. Properly insulate and protect the Hose Assembly when routing near hot objects (e.g. manifolds). Do not use any Hose in any application where failure of the Hose could result in the conveyed fluids (or vapors or mist from the conveyed fluids) contacting any open flame, molten metal, or other potential fire ignition source that could cause burning or explosion of the conveyed fluids or vapors.
- 2.5 Fluid Compatibility:** Hose, and Tube Assembly selection must assure compatibility of the Hose tube, cover, reinforcement, Tube, Plating and Seals with the fluid media used. See the fluid compatibility chart in the Parker publication for the product being considered or used. This information is offered only as a guide. Actual service life can only be determined by the end user by testing under all extreme conditions and other analysis. Hose, and Tube that is chemically compatible with a particular fluid must be assembled using Fittings and adapters containing likewise compatible seals. Flange or flare processes can change Tube material properties that may not be compatible with certain requirements such as NACE
- 2.6 Permeation:** Permeation (that is, seepage through the Hose or Seal) will occur from inside the Hose or Fitting to outside when Hose or Fitting is used with gases, liquid and gas fuels, and refrigerants (including but not limited to such materials as helium, diesel fuel, gasoline, natural gas, or LPG). This permeation may result in high concentrations of vapors which are potentially flammable, explosive, or toxic, and in loss of fluid. Dangerous explosions, fires, and other hazards can result when using the wrong Hose for such applications. The system designer must take into account the fact that this permeation will take place and must not use Hose or Fitting if this permeation could be hazardous. The system designer must take into account all legal, government, insurance, or any other special regulations which govern the use of fuels and refrigerants. Never use a Hose or Fitting even though the fluid compatibility is acceptable without considering the potential hazardous effects that can result from permeation through the Hose or Tube Assembly. Permeation of moisture from outside the Hose or Fitting to inside the Hose or Fitting will also occur in Hose or Tube assemblies, regardless of internal pressure. If this moisture permeation would have detrimental effects (particularly, but not limited to refrigeration and air conditioning systems), incorporation of sufficient drying capacity in the system or other appropriate system safeguards should be selected and used. The sudden pressure release of highly pressurized gas could also result in Explosive Decompression failure of permeated Seals and Hoses.
- 2.7 Size:** Transmission of power by means of pressurized fluid varies with pressure and rate of flow. The size of the components must be adequate to keep pressure losses to a minimum and avoid damage due to heat generation or excessive fluid velocity.
- 2.8 Routing:** Attention must be given to optimum routing to minimize inherent problems (kinking or flow restriction due to Hose collapse, twisting of the Hose, proximity to hot objects or heat sources). For additional routing recommendations see SAE J1273 and ISO 17165-2. Hose Assemblies have a finite life and should be installed in a manner that allows for ease of inspection and future replacement. Hose because of its relative short life, should not be used in residential and commercial buildings inside of inaccessible walls or floors, unless specifically allowed in the product literature. Always review all product literature for proper installation and routing instructions.
- 2.9 Environment:** Care must be taken to insure that the Hose, Tube and Fittings are either compatible with or protected from the environment (that is, surrounding conditions) to which they are exposed. Environmental conditions including but not limited to ultraviolet radiation, sunlight, heat, ozone, moisture, water, salt water, chemicals and air pollutants can cause degradation and premature failure.
- 2.10 Mechanical Loads:** External forces can significantly reduce Hose, Tube and Fitting life or cause failure. Mechanical loads which must be considered include excessive flexing, twist, kinking, tensile or side loads, bend radius, and vibration. Use of swivel type Fittings or adapters may be required to insure no twist is put into the Hose. Use of proper Hose or Tube clamps may also be required to reduce external mechanical loads. Unusual applications may require special testing prior to Hose selection.
- 2.11 Physical Damage:** Care must be taken to protect Hose from wear, snagging, kinking, bending smaller than minimum bend radius and cutting, any of which can cause premature Hose failure. Any Hose that has been kinked or bent to a radius smaller than the minimum bend radius, and any Hose that has been cut or is cracked or is otherwise damaged should be removed and discarded. Fittings with damages such as scratches on sealing surfaces and deformation should be replaced.
- 2.12 Proper End Fitting:** See instructions 3.2 through 3.5. These recommendations may be substantiated by testing to industry standards such as SAE J517 for hydraulic applications, or MIL-A-5070, AS1339, or AS3517 for Hoses from Parker's Stratoflex Products Division for aerospace applications.
- 2.13 Length:** When determining the proper Hose or Tube length of an assembly, be aware of Hose length change due to pressure, Tube length change due to thermal expansion or contraction, and Hose or Tube and machine tolerances and movement must be considered. When routing short hose assemblies, it is recommended that the minimum free hose length is always used. Consult the hose manufacturer for their minimum free hose length recommendations.

Hose assemblies should be installed in such a way that any motion or flexing occurs within the same plane.

- 2.14 Specifications and Standards:** When selecting Hose, Tube and Fittings, government, industry, and Parker specifications and recommendations must be reviewed and followed as applicable.
- 2.15 Hose Cleanliness:** Hose and Tube components may vary in cleanliness levels. Care must be taken to insure that the Hose and Tube Assembly selected has an adequate level of cleanliness for the application.
- 2.16 Fire Resistant Fluids:** Some fire resistant fluids that are to be conveyed by Hose or Tube require use of the same type of Hose or Tube as used with petroleum base fluids. Some such fluids require a special Hose, Tube, Fitting and Seal, while a few fluids will not work with any Hose at all. See instructions 2.5 and 1.5. The wrong Hose, Tube, Fitting or Seal may fail after a very short service. In addition, all liquids but pure water may burn fiercely under certain conditions, and even pure water leakage may be hazardous.
- 2.17 Radiant Heat:** Hose and Seals can be heated to destruction without contact by such nearby items as hot manifolds or molten metal. The same heat source may then initiate a fire. This can occur despite the presence of cool air around the Hose or Seal. Performance of Tube and Fitting subjected to the heat could be degraded.
- 2.18 Welding or Brazing:** When using a torch or arc welder in close proximity to hydraulic lines, the hydraulic lines should be removed or shielded with appropriate fire resistant materials. Flame or weld spatter could burn through the Hose or Seal and possibly ignite escaping fluid resulting in a catastrophic failure. Heating of plated parts, including Hose Fittings and adapters, above 450°F (232°C) such as during welding, brazing or soldering may emit deadly gases. Any elastomer seal on fittings shall be removed prior to welding or brazing, any metallic surfaces shall be protected after brazing or welding when necessary. Welding and brazing filler material shall be compatible with the Tube and Fitting that are joined.
- 2.19 Atomic Radiation:** Atomic radiation affects all materials used in Hose and Tube assemblies. Since the long-term effects may be unknown, do not expose Hose or Tube assemblies to atomic radiation. Nuclear applications may require special Tube and Fittings.
- 2.20 Aerospace Applications:** The only Hose, Tube and Fittings that may be used for in-flight aerospace applications are those available from Parker's Stratoflex Products Division. Do not use any other Hose or Fittings for in-flight applications. Do not use any Hose or Fittings from Parker's Stratoflex Products Division with any other Hose or Fittings, unless expressly approved in writing by the engineering manager or chief engineer of Stratoflex Products Division and verified by the user's own testing and inspection to aerospace industry standards.
- 2.21 Unlocking Couplings:** Ball locking couplings or other Fittings with quick disconnect ability can unintentionally disconnect if they are dragged over obstructions, or if the sleeve or other disconnect member, is bumped or moved enough to cause disconnect. Threaded Fittings should be considered where there is a potential for accidental uncoupling.

### 3.0 HOSE AND FITTINGS ASSEMBLY AND INSTALLATION INSTRUCTIONS

- 3.1 Component Inspection:** Prior to assembly, a careful examination of the Hose and Fittings must be performed. All components must be checked for correct style, size, catalog number, and length. The Hose must be examined for cleanliness, obstructions, blisters, cover looseness, kinks, cracks, cuts or any other visible defects. Inspect the Fitting and sealing surfaces for burrs, nicks, corrosion or other imperfections. Do NOT use any component that displays any signs of nonconformance.
- 3.2 Hose and Fitting Assembly:** Do not assemble a Parker Fitting on a Parker Hose that is not specifically listed by Parker for that Fitting, unless authorized in writing by the engineering manager or chief engineer of the appropriate Parker division. Do not assemble a Parker Fitting on another manufacturer's Hose or a Parker Hose on another manufacturer's Fitting unless (i) the engineering manager or chief engineer of the appropriate Parker division approves the Assembly in writing or that combination is expressly approved in the appropriate Parker literature for the specific Parker product, and (ii) the user verifies the Assembly and the application through analysis and testing. For Parker Hose that does not specify a Parker Fitting, the user is solely responsible for the selection of the proper Fitting and Hose Assembly procedures. See instruction 1.4. To prevent the possibility of problems such as leakage at the Fitting or system contamination, it is important to completely remove all debris from the cutting operation before installation of the Fittings. The Parker published instructions must be followed for assembling the Fittings on the Hose. These instructions are provided in the Parker Fitting catalog for the specific Parker Fitting being used, or by calling 1-800-CPARKER, or at [www.parker.com](http://www.parker.com).
- 3.3 Related Accessories:** Do not crimp or swage any Parker Hose or Fitting with anything but the listed swage or crimp machine and dies in accordance with Parker published instructions. Do not crimp or swage another manufacturer's Fitting with a Parker crimp or swage die unless authorized in writing by the engineering manager or chief engineer of the appropriate Parker division.
- 3.4 Parts:** Do not use any Parker Fitting part (including but not limited to socket, shell, nipple, or insert) except with the correct Parker mating parts, in accordance with Parker published instructions, unless authorized in writing by the engineering manager or chief engineer of the appropriate Parker division.
- 3.5 Field Attachable/Permanent:** Do not reuse any field attachable Hose Fitting that has blown or pulled off a Hose. Do not reuse a Parker permanent Hose Fitting (crimped or swaged) or any part thereof. Complete Hose Assemblies may only be reused after proper inspection under section 4.0. Do not assemble Fittings to any previously used hydraulic Hose that was in service, for use in a fluid power application.
- 3.6 Pre-Installation Inspection:** Prior to installation, a careful examination of the Hose Assembly must be performed. Inspect the Hose Assembly for any damage or defects. DO NOT use any Hose Assembly that displays any signs

- of nonconformance.
- 3.7 **Minimum Bend Radius:** Installation of a Hose at less than the minimum listed bend radius may significantly reduce the Hose life. Particular attention must be given to preclude sharp bending at the Hose to Fitting juncture. Any bending during installation at less than the minimum bend radius must be avoided. If any Hose is kinked during installation, the Hose must be discarded.
- 3.8 **Twist Angle and Orientation:** Hose Assembly installation must be such that relative motion of machine components does not produce twisting.
- 3.9 **Securement:** In many applications, it may be necessary to restrain, protect, or guide the Hose to protect it from damage by unnecessary flexing, pressure surges, and contact with other mechanical components. Care must be taken to insure such restraints do not introduce additional stress or wear points.
- 3.10 **Proper Connection of Ports:** Proper physical installation of the Hose Assembly requires a correctly installed port connection insuring that no twist or torque is transferred to the Hose when the Fittings are being tightened or otherwise during use.
- 3.11 **External Damage:** Proper installation is not complete without insuring that tensile loads, side loads, kinking, flattening, potential abrasion, thread damage or damage to sealing surfaces are corrected or eliminated. See instruction 2.10.
- 3.12 **System Checkout:** All air entrapment must be eliminated and the system pressurized to the maximum system pressure (at or below the Hose maximum working pressure) and checked for proper function and freedom from leaks. Personnel must stay out of potential hazardous areas while testing and using.
- 3.13 **Routing:** The Hose Assembly should be routed in such a manner so if a failure does occur, the escaping media will not cause personal injury or property damage. In addition, if fluid media comes in contact with hot surfaces, open flame or sparks, a fire or explosion may occur. See section 2.4.
- 3.14 **Ground Fault Equipment Protection Devices (GFEEDs):** **WARNING! Fire and Shock Hazard.** To minimize the danger of fire if the heating cable of a Multitube bundle is damaged or improperly installed, use a Ground Fault Equipment Protection Device. Electrical fault currents may be insufficient to trip a conventional circuit breaker. For ground fault protection, the IEEE 515: ([www.ansi.org](http://www.ansi.org)) standard for heating cables recommends the use of GFEEDs with a nominal 30 milliamperere trip level for "piping systems in classified areas, those areas requiring a high degree of maintenance, or which may be exposed to physical abuse or corrosive atmospheres".
- #### 4.0 TUBE AND FITTINGS ASSEMBLY AND INSTALLATION INSTRUCTIONS
- 4.1 **Component Inspection:** Prior to assembly, a careful examination of the Tube and Fittings must be performed. All components must be checked for correct style, size, material, seal, and length. Inspect the Fitting and sealing surfaces for burrs, nicks, corrosion, missing seal or other imperfections. Do NOT use any component that displays any signs of nonconformance.
- 4.2 **Tube and Fitting Assembly:** Do not assemble a Parker Fitting with a Tube that is not specifically listed by Parker for that Fitting, unless authorized in writing by the engineering manager or chief engineer of the appropriate Parker division. The Tube must meet the requirements specified to the Fitting. The Parker published instructions must be followed for assembling the Fittings to a Tube. These instructions are provided in the Parker Fitting catalog for the specific Parker Fitting being used, or by calling 1-800-CPARKER, or at [www.parker.com](http://www.parker.com).
- 4.3 **Related Accessories:** Do not preset or flange Parker Fitting components using another manufacturer's equipment or procedures unless authorized in writing by the engineering manager or chief engineer of the appropriate Parker division. Tube, Fitting component and tooling must be checked for correct style, size and material. Operation and maintenance of Related Accessories must be in accordance with the operation manual for the designated Accessory.
- 4.4 **Securement:** In many applications, it may be necessary to restrain, protect, or guide the Tube to protect it from damage by unnecessary flexing, pressure surges, vibration, and contact with other mechanical components. Care must be taken to insure such restraints do not introduce additional stress or wear points.
- 4.5 **Proper Connection of Ports:** Proper physical installation of the Tube Assembly requires a correctly installed port connection insuring that no torque is transferred to the Tube when the Fittings are being tightened or otherwise during use.
- 4.6 **External Damage:** Proper installation is not complete without insuring that tensile loads, side loads, flattening, potential abrasion, thread damage or damage to sealing surfaces are corrected or eliminated. See instruction 2.10.
- 4.7 **System Checkout:** All air entrapment must be eliminated and the system pressurized to the maximum system pressure (at or below the Tube Assembly maximum working pressure) and checked for proper function and freedom from leaks. Personnel must stay out of potential hazardous areas while testing and using.
- 4.8 **Routing:** The Tube Assembly should be routed in such a manner so if a failure does occur, the escaping media will not cause personal injury or property damage. In addition, if fluid media comes in contact with hot surfaces, open flame or sparks, a fire or explosion may occur. See section 2.4.
- #### 5.0 HOSE AND FITTING MAINTENANCE AND REPLACEMENT INSTRUCTIONS
- 5.1 Even with proper selection and installation, Hose life may be significantly reduced without a continuing maintenance program. The severity of the application, risk potential from a possible Hose failure, and experience with any Hose failures in the application or in similar applications should determine the frequency of the inspection and the replacement for the Products so that Products are replaced before any failure occurs. Certain products require maintenance and inspection per industry requirements. Failure to adhere to these requirements may lead to premature failure. A maintenance program must be established and followed by the user and, at minimum, must include instructions 5.2 through 5.7
- 5.2 **Visual Inspection Hose/Fitting:** Any of the following conditions require immediate shut down and replacement of the Hose Assembly:
- Fitting slippage on Hose;
  - Damaged, cracked, cut or abraded cover (any reinforcement exposed);
  - Hard, stiff, heat cracked, or charred Hose;
  - Cracked, damaged, or badly corroded Fittings;
  - Leaks at Fitting or in Hose;
  - Kinked, crushed, flattened or twisted Hose; and
  - Blistered, soft, degraded, or loose cover.
- 5.3 **Visual Inspection All Other:** The following items must be tightened, repaired, corrected or replaced as required:
- Leaking port conditions;
  - Excess dirt buildup;
  - Worn clamps, guards or shields; and
  - System fluid level, fluid type, and any air entrapment.
- 5.4 **Functional Test:** Operate the system at maximum operating pressure and check for possible malfunctions and leaks. Personnel must avoid potential hazardous areas while testing and using the system. See section 2.2.
- 5.5 **Replacement Intervals:** Hose assemblies and elastomeric seals used on Hose Fittings and adapters will eventually age, harden, wear and deteriorate under thermal cycling and compression set. Hose Assemblies and elastomeric seals should be inspected and replaced at specific replacement intervals, based on previous service life, government or industry recommendations, or when failures could result in unacceptable downtime, damage, or injury risk. See section 1.2. Hose and Fittings may be subjected to internal mechanical and/or chemical wear from the conveying fluid and may fail without warning. The user must determine the product life under such circumstances by testing. Also see section 2.5.
- 5.6 **Hose Inspection and Failure:** Hydraulic power is accomplished by utilizing high pressure fluids to transfer energy and do work. Hoses, Fittings and Hose Assemblies all contribute to this by transmitting fluids at high pressures. Fluids under pressure can be dangerous and potentially lethal and, therefore, extreme caution must be exercised when working with fluids under pressure and handling the Hoses transporting the fluids. From time to time, Hose Assemblies will fail if they are not replaced at proper time intervals. Usually these failures are the result of some form of misapplication, abuse, wear or failure to perform proper maintenance. When Hoses fail, generally the high pressure fluids inside escape in a stream which may or may not be visible to the user. Under no circumstances should the user attempt to locate the leak by "feeling" with their hands or any other part of their body. High pressure fluids can and will penetrate the skin and cause severe tissue damage and possibly loss of limb. Even seemingly minor hydraulic fluid injection injuries must be treated immediately by a physician with knowledge of the tissue damaging properties of hydraulic fluid. If a Hose failure occurs, immediately shut down the equipment and leave the area until pressure has been completely released from the Hose Assembly. Simply shutting down the hydraulic pump may or may not eliminate the pressure in the Hose Assembly. Many times check valves, etc., are employed in a system and can cause pressure to remain in a Hose Assembly even when pumps or equipment are not operating. Tiny holes in the Hose, commonly known as pinholes, can eject small, dangerously powerful but hard to see streams of hydraulic fluid. It may take several minutes or even hours for the pressure to be relieved so that the Hose Assembly may be examined safely. Once the pressure has been reduced to zero, the Hose Assembly may be taken off the equipment and examined. It must always be replaced if a failure has occurred. Never attempt to patch or repair a Hose Assembly that has failed. Consult the nearest Parker distributor or the appropriate Parker division for Hose Assembly replacement information. Never touch or examine a failed Hose Assembly unless it is obvious that the Hose no longer contains fluid under pressure. The high pressure fluid is extremely dangerous and can cause serious and potentially fatal injury.
- 5.7 **Elastomeric seals:** Elastomeric seals will eventually age, harden, wear and deteriorate under thermal cycling and compression set. Elastomeric seals should be inspected and replaced.
- 5.8 **Refrigerant gases:** Special care should be taken when working with refrigeration systems. Sudden escape of refrigerant gases can cause blindness if the escaping gases contact the eye and can cause freezing or other severe injuries if it contacts any other portion of the body.
- 5.9 **Compressed natural gas (CNG):** Parker CNG Hose Assemblies should be tested after installation and before use, and at least on a monthly basis per instructions provided on the Hose Assembly tag. The recommended procedure is to pressurize the Hose and check for leaks and to visually inspect the Hose for damage and to perform an electrical resistance test. Caution: Matches, candles, open flame or other sources of ignition shall not be used for Hose inspection. Leak check solutions should be rinsed off after use.
- #### 6.0 HOSE STORAGE
- 6.1 **Age Control:** Hose and Hose Assemblies must be stored in a manner that facilitates age control and first-in and first-out usage based on manufacturing date of the Hose and Hose Assemblies. Unless otherwise specified by the manufacturer or defined by local laws and regulations:
- 6.1.1 The shelf life of rubber hose in bulk form or hose made from two or more materials is 28 quarters (7 years) from the date of manufacture, with an extension of 12 quarters (3 years), if stored in accordance with ISO 2230;
- 6.1.2 The shelf life of thermoplastic and polytetrafluoroethylene hose is considered to be unlimited;
- 6.1.3 Hose assemblies that pass visual inspection and proof test shall not be stored for longer than 2 years.
- 6.1.4 **Storage:** Stored Hose and Hose Assemblies must not be subjected to damage that could reduce their expected service life and must be placed in a cool, dark and dry area with the ends capped. Stored Hose and Hose Assemblies must not be exposed to temperature extremes, ozone, oils, corrosive liquids or fumes, solvents, high humidity, rodents, insects, ultraviolet light, electromagnetic fields or radioactive materials.

## PARKER-HANNIFIN CORPORATION OFFER OF SALE

1. **Definitions.** As used herein, the following terms have the meanings indicated.

“Buyer” means any customer receiving a Quote for Products.

“Buyer’s Property” means any tools, patterns, plans, drawings, designs, specifications materials, equipment, or information furnished by Buyer, or which are or become Buyer’s property.

“Confidential Information” means any technical, commercial, or other proprietary information of Seller, including, without limitation, pricing, technical drawings or prints and/or part lists, which has been or will be disclosed, delivered, or made available, whether directly or indirectly, to Buyer.

“Goods” means any tangible part, system or component to be supplied by Seller.

“Intellectual Property Rights” means any patents, trademarks, copyrights, trade dress, trade secrets or similar rights.

“Products” means the Goods, Services and/or Software as described in a Quote.

“Quote” means the offer or proposal made by Seller to Buyer for the supply of Products.

“Seller” means Parker-Hannifin Corporation, including all divisions, subsidiaries and businesses selling Products under these Terms.

“Seller’s IP” means patents, trademarks, copyrights, or other intellectual property rights relating to the Products, including without limitation, names, designs, images, drawings, models, software, templates, information, any improvements or creations or other intellectual property developed prior to or during the relationship contemplated herein.

“Services” means any services to be provided by Seller.

“Software” means any software related to the Goods, whether embedded or separately downloaded.

“Special Tooling” means equipment acquired by Seller or otherwise owned by Seller necessary to manufacture Goods, including but not limited to tools, jigs, and fixtures.

“Terms” means the terms and conditions of this Offer of Sale.

2. **Terms.** All sales of Products by Seller will be governed by, and are expressly conditioned upon Buyer’s assent to, these Terms. These Terms are incorporated into any Quote provided by Seller to Buyer. Buyer’s order for any Products whether communicated to Seller verbally, in writing, by electronic data interface or other electronic commerce, shall constitute acceptance of these Terms. Seller objects to any contrary or additional terms or conditions of Buyer. Reference in Seller’s order acknowledgement to Buyer’s purchase order or purchase order number shall in no way constitute an acceptance of any of Buyer’s terms or conditions of purchase. Any Quote made by Seller to Buyer shall be considered a firm and definite offer and shall not be deemed to be otherwise despite any language on the face of the Quote. Seller reserves all rights to accept or reject any purported acceptance by Buyer to Seller’s Quote if such purported acceptance attempts to vary the terms of the Quote. If Seller ships Products after Buyer issues an acceptance to the Quote, any additional or different terms proposed by Buyer will not become part of the parties’ business relationship unless agreed to in a writing that is signed by an authorized representative of Seller, excluding email correspondence. If the transaction proceeds without such agreement on the part of Seller, the business relationship will be governed solely by these Terms and the specific terms in Seller’s Quote.

3. **Price; Payment.** The Products set forth in the Quote are offered for sale at the prices indicated in the Quote. Unless otherwise specifically stated in the Quote, prices are valid for thirty (30) days and do not include any sales, use, or other taxes or duties. Seller reserves the right to modify prices for any reason and at any time by giving ten (10) days prior written notice. Unless otherwise specified by Seller, all prices are F.C.A. Seller’s facility (INCOTERMS 2020). All sales are contingent upon credit approval and full payment for all purchases is due thirty (30) days from the date of invoice (or such date as may be specified in the Quote). Under any circumstances, Buyer may not withhold or suspend payment of any amounts due and payable as a deduction, set-off or recoupment of any amount, claim or dispute with Seller. Unpaid invoices beyond the specified payment date incur interest at the rate of 1.5% per month or

the maximum allowable rate under applicable law. Seller reserves the right to require advance payment or provision of securities for first and subsequent deliveries if there is any doubt, in Seller’s sole determination, regarding the Buyer’s creditworthiness or for other business reasons. If the requested advance payment or securities are not provided to Seller’s satisfaction, Seller reserves the right to suspend performance or reject the purchase order, in whole or in part, without prejudice to Seller’s other rights or remedies, including the right to full compensation. Seller may revoke or shorten any payment periods previously granted in Seller’s sole determination. The rights and remedies herein reserved to Seller are cumulative and in addition to any other or further rights and remedies available at law or in equity. No waiver by Seller of any breach by Buyer of any provision of these terms will constitute a waiver by Seller of any other breach of such provision.

4. **Shipment; Delivery; Title and Risk of Loss.** All delivery dates are approximate, and Seller is not responsible for damages or additional costs resulting from any delay. All deliveries are subject to our ability to procure materials from our suppliers. Regardless of the manner of shipment, delivery occurs and title and risk of loss or damage pass to Buyer, upon placement of the Products with the carrier at Seller’s facility. Unless otherwise agreed prior to shipment and for domestic delivery locations only, Seller will select and arrange, at Buyer’s sole expense, the carrier and means of delivery. When Seller selects and arranges the carrier and means of delivery, freight and insurance costs for shipment to the designated delivery location will be prepaid by Seller and added as a separate line item to the invoice. Buyer shall be responsible for any additional shipping charges incurred by Seller due to Buyer’s acts or omissions. Buyer shall not return or repackage any Products without the prior written authorization from Seller, and any return shall be at the sole cost and expense of Buyer.

5. **Warranty.** The warranty for the Products is as follows: (i) Goods are warranted against defects in material or workmanship for a period of twelve (12) months from the date of delivery or 2,000 hours of use, whichever occurs first; (ii) Services shall be performed in accordance with generally accepted practices and using the degree of care and skill that is ordinarily exercised and customary in the field to which the Services pertain and are warranted for a period of six (6) months from the date of completion of the Services; and (iii) Software is only warranted to perform in accordance with applicable specifications provided by Seller to Buyer for ninety (90) days from the date of delivery or, when downloaded by a Buyer or end-user, from the date of the initial download. All prices are based upon the exclusive limited warranty stated above, and upon the following disclaimer: **EXEMPTION CLAUSE; DISCLAIMER OF WARRANTY, CONDITIONS, REPRESENTATIONS: THIS WARRANTY IS THE SOLE AND ENTIRE WARRANTY, CONDITION, AND REPRESENTATION, PERTAINING TO PRODUCTS. SELLER DISCLAIMS ALL OTHER WARRANTIES, CONDITIONS, AND REPRESENTATIONS, WHETHER STATUTORY, EXPRESS OR IMPLIED, INCLUDING BUT NOT LIMITED TO THOSE RELATING TO DESIGN, NONINFRINGEMENT, MERCHANTABILITY, AND FITNESS FOR A PARTICULAR PURPOSE. SELLER DOES NOT WARRANT THAT THE SOFTWARE IS ERROR-FREE OR FAULT-TOLERANT, OR THAT BUYER’S USE THEREOF WILL BE SECURE OR UNINTERRUPTED, UNLESS OTHERWISE AUTHORIZED IN WRITING BY SELLER, THE SOFTWARE SHALL NOT BE USED IN CONNECTION WITH HAZARDOUS OR HIGH-RISK ACTIVITIES OR ENVIRONMENTS. EXCEPT AS EXPRESSLY STATED HEREIN, ALL PRODUCTS ARE PROVIDED “AS IS”.**

6. **Claims; Commencement of Actions.** Buyer shall promptly inspect all Products upon receipt. No claims for shortages will be allowed unless reported to Seller within ten (10) days of delivery. Buyer shall notify Seller of any alleged breach of warranty within thirty (30) days after the date the non-conformance is or should have been discovered by Buyer. Any claim or action against Seller based upon breach of contract or any other theory, including tort, negligence, or otherwise must be commenced within twelve (12) months from the date of the alleged breach or other alleged event, without regard to the date of discovery.



**7. LIMITATION OF LIABILITY. IN THE EVENT OF A BREACH OF WARRANTY, SELLER WILL, AT ITS OPTION, REPAIR OR REPLACE THE NON-CONFORMING PRODUCTS, RE-PERFORM THE SERVICES, OR REFUND THE PURCHASE PRICE PAID WITHIN A REASONABLE PERIOD OF TIME. IN NO EVENT IS SELLER LIABLE FOR ANY SPECIAL, INDIRECT, INCIDENTAL OR CONSEQUENTIAL DAMAGES INCLUDING ANY LOSS OF REVENUE OR PROFITS, WHETHER BASED IN CONTRACT, TORT OR OTHER LEGAL THEORY. IN NO EVENT SHALL SELLER'S LIABILITY UNDER ANY CLAIM MADE BY BUYER EXCEED THE PURCHASE PRICE PAID FOR THE PRODUCTS.**

**8. Confidential Information.** Buyer acknowledges and agrees that Confidential Information has been and will be received in confidence and will remain the property of Seller. Buyer further agrees that it will not use Seller's Confidential Information for any purpose other than for the benefit of Seller and shall return all such Confidential Information to Seller within thirty (30) days upon request.

**9. Loss to Buyer's Property.** Buyer's Property will be considered obsolete and may be destroyed by Seller after two (2) consecutive years have elapsed without Buyer ordering the Products manufactured using Buyer's Property.

Also, Seller shall not be responsible for any loss or damage to Buyer's Property while it is in Seller's possession or control.

**10. Special Tooling.** Seller may impose a tooling charge for any Special Tooling. Special Tooling shall be and remain Seller's property. In no event will Buyer acquire any interest in the Special Tooling, even if such Special Tooling has been specially converted or adapted for manufacture of Goods for Buyer and notwithstanding any charges paid by Buyer. Unless otherwise agreed, Seller has the right to alter, discard or otherwise dispose of any Special Tooling or other property owned by Seller in its sole determination at any time.

**11. Security Interest.** To secure payment of all sums due from Buyer, Seller retains a security interest in all Products delivered to Buyer and, Buyer's acceptance of these Terms is deemed to be a Security Agreement under the Uniform Commercial Code. Buyer authorizes Seller as its attorney to execute and file on Buyer's behalf all documents Seller deems necessary to perfect Seller's security interest.

**12. User Responsibility.** Buyer, through its own analysis and testing, is solely responsible for making the final selection of the Products and assuring that all performance, endurance, maintenance, safety and warning requirements of the application of the Products are met. Buyer must analyze all aspects of the application and follow applicable industry standards, specifications, and any technical information provided with the Quote or the Products, such as Seller's instructions, guides and specifications. If Seller provides options of or for Products based upon data or specifications provided by Buyer, Buyer is responsible for determining that such data and specifications are suitable and sufficient for all applications and reasonably foreseeable uses of the Products. In the event Buyer is not the end-user of the Products, Buyer will ensure such end-user complies with this paragraph.

**13. Use of Products, Indemnity by Buyer.** Buyer shall comply with all instructions, guides and specifications provided by Seller with the Quote or the Products. If Buyer uses or resells the Products in any way prohibited by Seller's instructions, guides or specifications, or Buyer otherwise fails to comply with Seller's instructions, guides and specifications, Buyer acknowledges that any such use, resale, or non-compliance is at Buyer's sole risk. Further, Buyer shall indemnify, defend, and hold Seller harmless from any losses, claims, liabilities, damages, lawsuits, judgments and costs (including attorney fees and defense costs), whether for personal injury, property damage, intellectual property infringement or any other claim, arising out of or in connection with: (a) improper selection, design, specification, application, or any misuse of Products; (b) any act or omission, negligent or otherwise, of Buyer; (c) Seller's use of Buyer's Property; (d) damage to the Products from an external cause, repair or attempted repair by anyone other than Seller, failure to follow instructions, guides and specifications provided by Seller, use with goods not provided by Seller, or opening, modifying, deconstructing, tampering with or repackaging the Products; or (e) Buyer's failure to comply with

these Terms, including any legal or administrative proceedings, collection efforts, or other actions arising from or relating to such failure to comply. Seller shall not indemnify Buyer under any circumstance except as otherwise provided in these Terms.

**14. Cancellations and Changes.** Buyer may not cancel or modify, including but not limited to movement of delivery dates for the Products, any order for any reason except with Seller's written consent and upon terms that will indemnify, defend and hold Seller harmless against all direct, incidental and consequential loss or damage and any additional expense. Seller, at any time, may change features, specifications, designs and availability of Products.

**15. Assignment.** Buyer may not assign its rights or obligations without the prior written consent of Seller.

**16. Force Majeure.** Seller is not liable for delay or failure to perform any of its obligations by reason of any events or circumstances beyond its reasonable control. Such circumstances include without limitation: accidents, labor disputes or stoppages, government acts or orders, acts of nature, pandemics, epidemics, other widespread illness, or public health emergency, cyber related disruptions, cyber-attacks, ransomware sabotage, delays or failures in delivery from carriers or suppliers, shortages of materials, sudden increases in the price of raw material or components, shutdowns or slowdowns affecting the supply of raw materials or components, or the transportation thereof, oil shortages or oil price increases, energy crisis, energy or fuel interruption, war (whether declared or not) or the serious threat of same, riots, rebellions, acts of terrorism, embargoes, fire or any reason whether similar to the foregoing or otherwise. Seller will resume performance as soon as practicable after the event of force majeure has been removed. All delivery dates affected by an event of force majeure shall be tolled for the duration of such event of force majeure and rescheduled for mutually agreed dates as soon as practicable after the event of force majeure ceases to exist. The right to allocate capacity is in the Seller's sole discretion. An event of force majeure shall not include financial distress, insolvency, bankruptcy, or other similar conditions affecting one of the parties, affiliates and/or subcontractors. An event of force majeure in the meaning of these Terms means any circumstances beyond Seller's control that permanently or temporarily hinders performance, even where that circumstance was already foreseen. Buyer shall not be entitled to cancel any orders following its claim of an event of force majeure.

**17. Waiver and Severability.** Failure to enforce any provision of these Terms will not invalidate that provision; nor will any such failure prejudice either party's right to enforce that provision in the future. Invalidation of any provision of these Terms shall not invalidate any other provision herein and, the remaining provisions will remain in full force and effect.

**18. Duration.** Unless otherwise stated in the Quote, any agreement governed by or arising from these Terms shall: (a) be for an initial duration of one (1) year; and (b) shall automatically renew for successive one-year terms unless terminated by Buyer with at least 180-days written notice to Seller or if Seller terminates the agreement pursuant to Section 19 of these Terms.

**19. Termination.** Seller may, without liability to Buyer, terminate any agreement governed by or arising from these Terms for any reason and at any time by giving Buyer thirty (30) days prior written notice. Seller may immediately terminate, in writing, if Buyer: (a) breaches any provision of these Terms, (b) becomes or is deemed insolvent, (c) appoints or has appointed a trustee, receiver or custodian for all or any part of Buyer's property, (d) files a petition for relief in bankruptcy on its own behalf, or one is filed against Buyer by a third party, (e) makes an assignment for the benefit of creditors; or (f) dissolves its business or liquidates all or a majority of its assets.

**20. Ownership of Rights.** Buyer agrees that (a) Seller (and/or its affiliates) owns or is the valid licensee of Seller's IP and (b) the furnishing of information, related documents or other materials by Seller to Buyer does not grant or transfer any ownership interest or license in or to Seller's IP to Buyer, unless expressly agreed in writing. Without limiting the foregoing, Seller retains ownership of all Software supplied to Buyer. In no event shall Buyer obtain any greater right in and to the Software than a right in a license limited to the use thereof and subject to compliance

with any other terms provided with the Software. Buyer further agrees that it will not, directly or through intermediaries, reverse engineer, decompile, or disassemble any Software (including firmware) comprising or contained within a Product, except and only to the extent that such activity may be expressly permitted, either by applicable law or, in the case of open source software, the applicable open source license.

**21. Indemnity for Infringement of Intellectual Property Rights.** Seller is not liable for infringement of any Intellectual Property Rights except as provided in this Section. Seller will defend at its expense and will pay the cost of any settlement or damages awarded in an action brought against Buyer based on a third-party claim that one or more of the Products infringes the Intellectual Property Rights of a third party in the country of delivery of the Products by Seller to Buyer. Seller's obligation to defend and indemnify Buyer is contingent on Buyer notifying Seller within ten (10) days after Buyer becomes aware of any such claim, and Seller having sole control over the defense of the claim including all negotiations for settlement or compromise. If one or more Products is subject to such a claim, Seller may, at its sole expense and option, procure for Buyer the right to continue using the Products, replace or modify the Products to render them non-infringing, or offer to accept return of the Products and refund the purchase price less a reasonable allowance for depreciation. Seller has no obligation or liability for any claim of infringement: (i) arising from information provided by Buyer (including Seller's use of Buyer's Property); or (ii) directed to any Products for which the designs are specified in whole or part by Buyer; or (iii) resulting from the modification, combination or use in a system of any Products. The foregoing provisions of this Section constitute Seller's sole and exclusive liability and Buyer's sole and exclusive remedy for claims of infringement of Intellectual Property Rights.

**22. Governing Law.** These Terms, the terms of any Quote, and the sale and delivery of all Products are deemed to have taken place in, and shall be governed and construed in accordance with, the laws of the State of Ohio, as applicable to contracts executed and wholly performed therein and without regard to conflicts of laws principles. Buyer irrevocably agrees and consents to the exclusive jurisdiction and venue of the courts of Cuyahoga County, Ohio with respect to any dispute, controversy or claim arising out of or relating to the sale and delivery of the Products.

**23. Entire Agreement.** These Terms, along with the terms set forth in the Quote, forms the entire agreement between the Buyer and Seller and constitutes the final, complete and exclusive expression of the terms of sale and purchase. In the event of a conflict between any term set forth in the Quote and these Terms, the terms set forth in the Quote shall prevail. All prior or contemporaneous written or oral agreements or negotiations with respect to the subject matter shall have no effect. No modification to these Terms will be binding on Seller unless agreed to in a writing that is signed by an authorized representative of Seller, excluding email correspondence, 'clickwrap' or other purported electronic assent to different or additional terms. Sections 2-25 of these Terms shall survive termination or cancellation of any agreement governed by or arising from these Terms.

**24. No 'Wrap' Agreements/No Authority to Bind.** Seller's clicking any buttons or any similar action, such as clicking "I Agree" or "Confirm," to utilize Buyer's software or webpage for the placement of orders, is NOT an agreement to Buyer's Terms and Conditions. **NO EMPLOYEE, AGENT OR REPRESENTATIVE OF SELLER HAS THE AUTHORITY TO BIND SELLER BY THE ACT OF CLICKING ANY BUTTON OR SIMILAR ACTION ON BUYER'S WEBSITE OR PORTAL.**

**25. Compliance with Laws.** Buyer agrees to comply with all applicable laws, regulations, and industry and professional standards, including those of the United States of America, and the country or countries in which Buyer may operate, including without limitation the U.S. Foreign Corrupt Practices Act ("FCPA"), the U.S. Anti-Kickback Act ("Anti-Kickback Act"), U.S. and E.U. export control and sanctions laws ("Export Laws"), the U.S. Food Drug and Cosmetic Act ("FDCA"), and the rules and regulations promulgated by the U.S. Food and Drug Administration ("FDA"), each as currently amended. Buyer agrees to indemnify, defend, and hold harmless Seller from the consequences of any violation of such laws, regulations and standards by Buyer, its employees or agents. Buyer represents that it is familiar with all applicable provisions of the FCPA, the

Anti-Kickback Act, Export Laws, the FDCA and the FDA and certifies that Buyer will adhere to the requirements thereof and not take any action that would make Seller violate such requirements. Buyer represents and agrees that Buyer will not make any payment or give anything of value, directly or indirectly, to any governmental official, foreign political party or official thereof, candidate for foreign political office, or commercial entity or person, for any improper purpose, including the purpose of influencing such person to purchase Products or otherwise benefit the business of Seller. Buyer further represents and agrees that it will not receive, use, service, transfer or ship any Products from Seller in a manner or for a purpose that violates Export Laws or would cause Seller to be in violation of Export Laws. Buyer agrees to promptly and reliably provide Seller all requested information or documents, including end-user statements and other written assurances, concerning Buyer's ongoing compliance with Export Law.

# Parker's Motion & Control Product Groups

*At Parker, we're guided by a relentless drive to help our customers become more productive and achieve higher levels of profitability by engineering the best systems for their requirements. It means looking at customer applications from many angles to find new ways to create value. Whatever the motion and control technology need, Parker has the experience, breadth of product and global reach to consistently deliver. No company knows more about motion and control technology than Parker.*

**For further info call  
1 800 C-Parker  
(1 800 272 7537).**



## **Aerospace**

### **Key Markets**

Aftermarket services  
Commercial transports  
Engines  
General & business aviation  
Helicopters  
Launch vehicles  
Military aircraft  
Missiles  
Power generation  
Regional transports  
Unmanned aerial vehicles

### **Key Products**

Control systems & actuation products  
Engine systems & components  
Fluid conveyance systems & components  
Fluid metering, delivery & atomization devices  
Fuel systems & components  
Fuel tank inerting systems  
Hydraulic systems & components  
Thermal management  
Wheels & brakes



## **Automation**

### **Key Markets**

Alternative energy  
Conveyor & material handling  
Factory automation  
Food & beverage  
Life sciences & medical  
Machine tools  
Packaging machinery  
Paper machinery  
Plastics machinery  
Primary metals  
Safety & security  
Semiconductor & electronics  
Transportation & automotive

### **Key Products**

AC/DC drives & systems  
Air preparation  
Electric actuators, gantry robots & slides  
Human machine interfaces  
Inverters  
Manifolds  
Miniature fluidics  
Pneumatic actuators & grippers  
Pneumatic valves & controls  
Rotary actuators  
Stepper motors, servo motors, drives & controls  
Structural extrusions  
Vacuum generators, cups & sensors



## **Climate & Industrial Controls**

### **Key Markets**

Agriculture  
Air conditioning  
Construction Machinery  
Food & beverage  
Industrial machinery  
Life sciences  
Oil & gas  
Precision cooling  
Process  
Refrigeration  
Transportation

### **Key Products**

Accumulators  
Advanced actuators  
CO2 controls  
Electronic controllers  
Filter driers  
Hand shut-off valves  
Heat exchangers  
Hose & fittings  
Pressure regulating valves  
Refrigerant distributors  
Safety relief valves  
Smart pumps  
Solenoid valves  
Thermostatic expansion valves



## **Filtration**

### **Key Markets**

Aerospace  
Food & beverage  
Industrial plant & equipment  
Life sciences  
Marine  
Mobile equipment  
Oil & gas  
Power generation & renewable energy  
Process  
Transportation  
Water Purification

### **Key Products**

Analytical gas generators  
Compressed air filters & dryers  
Engine air, coolant, fuel & oil filtration systems  
Fluid condition monitoring systems  
Hydraulic & lubrication filters  
Hydrogen, nitrogen & zero air generators  
Instrumentation filters  
Membrane & fiber filters  
Microfiltration  
Sterile air filtration  
Water desalination & purification filters & systems



## **Fluid Connectors**

### **Key Markets**

Aerial lift  
Agriculture  
Bulk chemical handling  
Construction machinery  
Food & beverage  
Fuel & gas delivery  
Industrial machinery  
Life sciences  
Marine  
Mining  
Mobile  
Oil & gas  
Renewable energy  
Transportation

### **Key Products**

Check valves  
Connectors for low pressure fluid conveyance  
Deep sea umbilicals  
Diagnostic equipment  
Hose couplings  
Industrial hose  
Mooring systems & power cables  
PTFE hose & tubing  
Quick couplings  
Rubber & thermoplastic hose  
Tube fittings & adapters  
Tubing & plastic fittings



## **Hydraulics**

### **Key Markets**

Aerial lift  
Agriculture  
Alternative energy  
Construction machinery  
Forestry  
Industrial machinery  
Machine tools  
Marine  
Material handling  
Mining  
Oil & gas  
Power generation  
Refuse vehicles  
Renewable energy  
Truck hydraulics  
Turf equipment

### **Key Products**

Accumulators  
Cartridge valves  
Electrohydraulic actuators  
Human machine interfaces  
Hybrid drives  
Hydraulic cylinders  
Hydraulic motors & pumps  
Hydraulic systems  
Hydraulic valves & controls  
Hydrostatic steering  
Integrated hydraulic circuits  
Power take-offs  
Power units  
Rotary actuators  
Sensors



## **Instrumentation**

### **Key Markets**

Alternative fuels  
Biopharmaceuticals  
Chemical & refining  
Food & beverage  
Marine & shipbuilding  
Medical & dental  
Microelectronics  
Nuclear Power  
Offshore oil exploration  
Oil & gas  
Pharmaceuticals  
Power generation  
Pulp & paper  
Steel  
Water/wastewater

### **Key Products**

Analytical Instruments  
Analytical sample conditioning products & systems  
Chemical injection fittings & valves  
Fluoropolymer chemical delivery fittings, valves & pumps  
High purity gas delivery fittings, valves, regulators & digital flow controllers  
Industrial mass flow meters/controllers  
Permanent no-weld tube fittings  
Precision industrial regulators & flow controllers  
Process control double block & bleeds  
Process control fittings, valves, regulators & manifold valves



## **Seal**

### **Key Markets**

Aerospace  
Chemical processing  
Consumer  
Fluid power  
General industrial  
Information technology  
Life sciences  
Microelectronics  
Military  
Oil & gas  
Power generation  
Renewable energy  
Telecommunications  
Transportation

### **Key Products**

Dynamic seals  
Elastomeric o-rings  
Electro-medical instrument design & assembly  
EMI shielding  
Extruded & precision-cut, fabricated elastomeric seals  
High temperature metal seals  
Homogeneous & inserted elastomeric shapes  
Medical device fabrication & assembly  
Metal & plastic retained composite seals  
Shielded optical windows  
Silicone tubing & extrusions  
Thermal management  
Vibration dampening



**ENGINEERING YOUR SUCCESS.**

# Parker Fluid Connectors Group

## North American Divisions & Distribution Service Centers

**Your complete source** for quality tube fittings, hose & hose fittings, brass & composite fittings, quick-disconnect couplings, valves and assembly tools, locally available from a worldwide network of authorized distributors.

### **Fittings:**

Available in inch and metric sizes covering SAE, BSP, DIN, GAZ, JIS and ISO thread configurations, manufactured from steel, stainless steel, brass, aluminum, nylon and thermoplastic.

### **Hose, Tubing and Bundles:**

Available in a wide variety of sizes and materials including rubber, wire-reinforced, thermoplastic, hybrid and custom compounds.

### **Worldwide Availability:**

Parker operates Fluid Connectors manufacturing locations and sales offices throughout North America, South America, Europe and Asia-Pacific.

**For information**, call toll free...

**1-800-C-PARKER**  
**(1-800-272-7537)**

### **North American Divisions** **Fluid System Connectors** **Division**

Otsego, MI  
phone 269 692 6555  
fax 269 694 4614

**Engineering Support:**  
FSC.Apps@support.parker.com

**Customer Support:**  
FSC.Support@support.parker.com

**Quote Support:**  
FSC.Quotes@support.parker.com

### **Hose Products Division**

Wickliffe, OH  
phone 440 943 5700  
fax 440 943 3129

### **Parflex Division**

Ravenna, OH  
phone 330 296 2871  
fax 330 296 8433

### **Quick Coupling Division**

Minneapolis, MN  
phone 763 544 7781  
fax 763 544 3418

### **Tube Fittings Division**

Columbus, OH  
phone 614 279 7070  
fax 614 279 7685

### **Distribution Service** **Centers**

#### **Buena Park, CA**

phone 714 522 8840  
fax 714 994 1183

#### **Conyers, GA**

phone 770 929 0330  
fax 770 929 0230

#### **Louisville, KY**

phone 502 937 1322  
fax 502 937 4180

#### **Portland, OR**

phone 503 283 1020  
fax 503 283 2201

#### **Toledo, OH**

phone 419 878 7000  
fax 419 878 7001  
fax 419 878 7420  
(FCG Kit Operations)

#### **Canada**

##### **Milton, ONT**

phone 905 693 3000  
fax 905 876 1958

#### **Mexico**

##### **Toluca, MEX**

phone (52) 722 2754 200  
fax (52) 722 2722 168

